

# 5-Piece MDF

*"It's easy to order from WalzCraft!"*

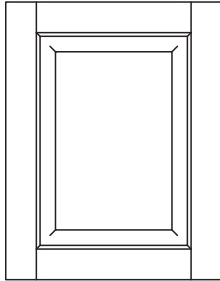

**Style 34SQ**  
**Drawer Front**  
*(See page 164-Look "A")*  
 Price Class: 1001  
 Min. Size: 3x3



**Style 10**  
 Price Class: 540  
 Min. Size: 8x8

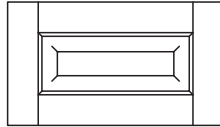

**Style 10\***  
 Price Class: 540  
 Min. Size: 8x8

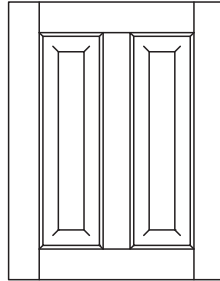

**Style 1010**  
 Price Class: 541  
 Min. Size: 13<sup>3</sup>/<sub>4</sub>x8

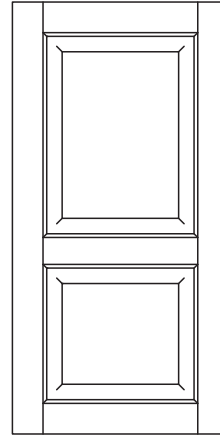

**Style 1000**  
 Price Class: 541  
 Min. Size: 8x15<sup>1</sup>/<sub>2</sub>

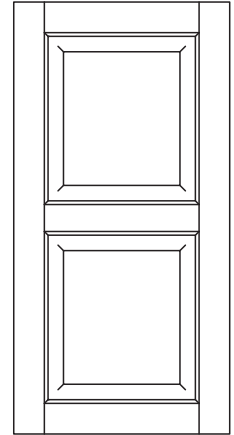

**Style 8000**  
 Price Class: 541  
 Min. Size: 8x13<sup>3</sup>/<sub>4</sub>

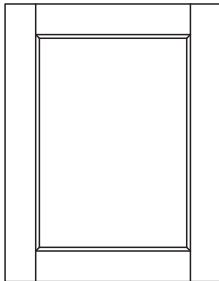

**Style 40**  
 Price Class: 550  
 Min. Size: 6<sup>5</sup>/<sub>8</sub>x6

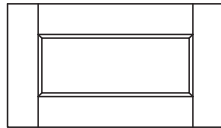

**Style 40\***  
 Price Class: 550  
 Min. Size: 6<sup>5</sup>/<sub>8</sub>x6

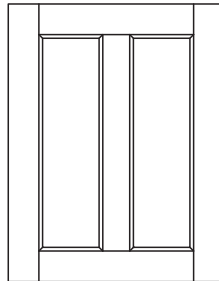

**Style 4040**  
 Price Class: 551  
 Min. Size: 9<sup>3</sup>/<sub>4</sub>X6<sup>5</sup>/<sub>8</sub>

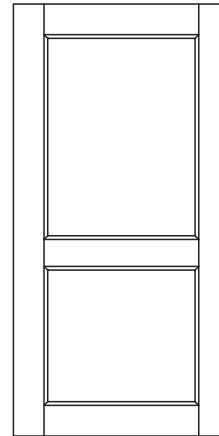

**Style 4043**  
 Price Class: 551  
 Min. Size: 6<sup>5</sup>/<sub>8</sub>x11<sup>1</sup>/<sub>4</sub>

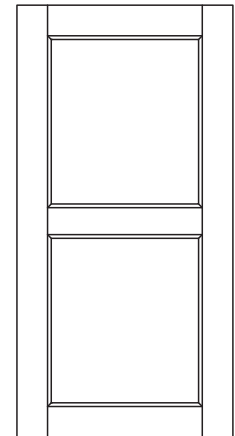

**Style 4044**  
 Price Class: 551  
 Min. Size: 6<sup>5</sup>/<sub>8</sub>x9<sup>3</sup>/<sub>4</sub>

Square Foot Prices Per Price Class	540	541	550	551	1001
Raw MDF	See our "Master" Specification Catalog for Pricing				
Frame Only					

## 5-Piece MDF Door and Drawer Front Notes

1) Profile Option Availability	<p><b>Stile and Rail Profiles</b> = All "Traditional" Stile &amp; Rail Profile options.  <b>Center Panel Profiles</b> = All Center Panel Profile options.  <b>Outside Edge Profiles</b> = All Outside Edge Profile options.</p> <p><i>See our "Master" Specification Catalog for profile options.</i></p>
2) Minimum for Pricing	<b>1 square foot minimum</b> per piece for pricing.
3) Stile & Rail Dimensions	5-Piece MDF Doors and Drawer Fronts are constructed with 2 <sup>1</sup> / <sub>4</sub> " stile and rail dimensions as a standard.
4) Thickness	Available in 3/4" thickness only.
5) Applied Molding on MDF	If ordering an applied molding on an MDF product, the applied molding will utilize a Maple-Hard/Soft-Paint Grade Mixed (Budget) wood specie.
6) Distressing Option	Simulated or Renaissance Distressing are not available.
7) Rub Through Option	RBT100 and RBT200 are not available.



WalzCraft.com



(Phone) 1-800-237-1326 7:00AM - 4:30PM CST (24 Hour Fax) 1-608-781-3667

# MDF & RTF

*"It's easy to order from WalzCraft!"*

## MDF Door & Drawer Front Construction and Ordering

### HOW MANY PASSES IS MY DOOR?

The price of MDF and RTF doors is influenced by the complexity of the CNC routing that is required. In order to price a door, you will need to know how many "passes" (CNC Router cycles) are made by the router. The number of "passes" is listed on the profile drawings in our Specification Catalog. Please note that some doors indicated as "6 pass" may actually have more than 6 router passes, but for pricing purposes WalzCraft prices these as "6 pass" doors.

Doors and drawer fronts are constructed of premium,  $\frac{3}{4}$ " or 1" thick 48# MDF that is precision routed in the style and profiles that you select.

#### To Order MDF Doors or Drawer Fronts...

- 1) Select one of the available Stile & Rail/Panel Profile combinations. Note the number of "passes" required.
- 2) Select an Outside Edge.
- 3) Select one of the available Door Styles.

## MDF Door & Drawer Front Price Calculation



### Price Calculation for Raw MDF



Find the price per square foot that matches the number of "passes" required. You can determine the number of passes by looking at the drawings in our Specification Catalog. Multiply the square footage of the door or drawer front by the price per square foot to arrive at the cost of the door. For pricing purposes, there is a **1 square foot minimum** per piece for doors, frame doors and the **518\*** drawer front. **Style 500\*** and RP drawer fronts have a  $\frac{1}{2}$  **square foot minimum** per piece for pricing.

## RTF Door & Drawer Front Construction and Ordering

Doors and drawer fronts are constructed of premium,  $\frac{3}{4}$ " or 1" thick 48# MDF with an Almond or White back. They are precision routed in the styles and profiles that you select. The RTF foil covers the face and edges of the doors and drawer fronts.

#### To Order an RTF Door...

- 1) Select one of the Stile & Rail/Panel Profile combinations. Note the number of 'passes' required.
- 2) Select an Outside Edge.
- 3) Select one of the available Door Styles.
- 4) Select one of the available foil colors.
- 5) For woodgrain foils, please specify either horizontal or vertical grain for the doors and drawer fronts.  
*Also specify either Almond or White as the color of the back of the door.*
- 6) White High Gloss requires a special board for pressing and is only available with a white back.

## RTF Care and Cleaning

### RTF Cleaning and Care

RTF doors are built to need very little attention. We recommend that you use only warm soapy water (*dish soap*) to clean them. Never use anything with abrasive in it. If using stronger cleaning materials, always test a new cleaning solution on a small less conspicuous area before doing an entire kitchen. If RTF doors are installed near a self cleaning oven or any other appliance emitting high heat, we suggest you open the cabinet doors to avoid heat exposure.



WalzCraft<sup>®</sup>.com



(Phone) 1-800-237-1326 7:00AM - 4:30PM CST (24 Hour Fax) 1-608-781-3667

# 1-Piece MDF & RTF

"Where Custom Made Quality Begins" ®

## RTF Color Options and Door & Drawer Front Price Calculation

RTF Foil Color Options	Square Foot Charge	Foil Thickness
Almond Crystal	<b>Square Foot Pricing: See our "Master" Specification Catalog</b>	.012"
Antique White		.012"
Arctic Ribbon*		.014"
Bamboo*		.012"
Birds Eye Maple*		.015"
Black Crystal		.012"
Brushed Steel*		.012"
Cappuccino Cherry*		.012"
Frosty White		.012"
Fusion Maple*		.012"
Italian Macassar*		.016"
Italian Wenge*		.016"
Italian Zebrano*		.016"
Leather Black		.016"
Leather Brown		.016"
Leather White Alligator		.012"
Persian Cherry*		.012"
Pickled Maple*		.012"
Sculpted Wenge*		.014"
Solar Oak*		.012"
Summer Flame*	.012"	
Walnut*	.016"	
Westminster Mahogany*	.016"	
White Crystal	.012"	
White High Gloss	.022"	
White Matte	.016"	
White Woodgrain*	.012"	

\* These materials have a grain direction. Please specify Horizontal or Vertical Grain with ordering.

★ Price Calculation for RTF ★

RTF doors and drawer fronts are priced the same as MDF doors and drawer fronts except that an upcharge for the foil color is added to the price per square foot. The accompanying chart lists the upcharges for the various foil colors. **RTF products are considered a finished product.**

**Pricing Example:**

- **Step 1)** Calculate the square footage of the door.
- **Step 2)** Determine the square foot price for a MDF door from the price grid.
- **Step 3)** Determine the upcharge for the foil color you prefer.
- **Step 4)** Add the square foot cost and the square foot foil color upcharge together.
- **Step 5)** Multiply the square footage of the door by the total square footage price.
- **Step 6)** Add the cost of non-standard parts or other options to the cost of the door.
- **Step 7)** If your order is a Quick Ship, apply the upcharge to obtain your price for this door.



WalzCraft.com



(Phone) 1-800-237-1326 7:00AM - 4:30PM CST (24 Hour Fax) 1-608-781-3667

# 1-Piece MDF & RTF

“Visit our Web Site at [www.WalzCraft.com](http://www.WalzCraft.com).”

## RTF Sheet Stock Pricing

Price Per Sheet Part # 89	4' x 8' RTF Loose Foil		2' x 8' RTF Loose Foil		4'x8' RTF Loose Foil with 3M PSA (Pressure Sensitive Adhesive) Applied to Back		2'x8' RTF Loose Foil with 3M PSA (Pressure Sensitive Adhesive) Applied to Back		4' x 8' RTF Foil with Phenolic Back		2' x 8' RTF Foil with Phenolic Back	
	Price	Approximate Actual Size	Price	Approximate Actual Size	Price	Approximate Actual Size	Price	Approximate Actual Size	Price	Approximate Actual Size	Price	Approximate Actual Size
Almond Crystal		51" x 97"		25.5" x 97"		49" x 97"		24.5" x 97"		49" x 97"		24.5" x 97"
Antique White		51" x 97"		25.5" x 97"		49" x 97"		24.5" x 97"		49" x 97"		24.5" x 97"
Arctic Ribbon		52" x 97"		26" x 97"		49" x 97"		24.5" x 97"		49" x 97"		24.5" x 97"
Bamboo		52" x 97"		26" x 97"		49" x 97"		24.5" x 97"		49" x 97"		24.5" x 97"
Birds Eye Maple		56" x 97"		27" x 97"		49" x 97"		24.5" x 97"		49" x 97"		24.5" x 97"
Black Crystal		52" x 97"		26" x 97"		49" x 97"		24.5" x 97"		49" x 97"		24.5" x 97"
Brushed Steel		52" x 97"		26" x 97"		49" x 97"		24.5" x 97"		49" x 97"		24.5" x 97"
Cappuccino Cherry		56" x 97"		27" x 97"		49" x 97"		24.5" x 97"		49" x 97"		24.5" x 97"
Frosty White		57" x 97"		27.5" x 97"		49" x 97"		24.5" x 97"		49" x 97"		24.5" x 97"
Fusion Maple		57" x 97"		27.5" x 97"		49" x 97"		24.5" x 97"		49" x 97"		24.5" x 97"
Italian Macassar		56" x 97"		27" x 97"		49" x 97"		24.5" x 97"		49" x 97"		24.5" x 97"
Italian Wenge		56" x 97"		27" x 97"		49" x 97"		24.5" x 97"		49" x 97"		24.5" x 97"
Italian Zebrano		56" x 97"		27" x 97"		49" x 97"		24.5" x 97"		49" x 97"		24.5" x 97"
Leather Black	Please Call For Pricing	56" x 97"	Please Call For Pricing	27" x 97"	Please Call For Pricing	49" x 97"	Please Call For Pricing	24.5" x 97"	Please Call For Pricing	49" x 97"	Please Call For Pricing	24.5" x 97"
Leather Brown		56" x 97"		27" x 97"		49" x 97"		24.5" x 97"		49" x 97"		24.5" x 97"
Leather White Aligator		56" x 97"		27" x 97"		49" x 97"		24.5" x 97"		49" x 97"		24.5" x 97"
Persian Cherry		52" x 97"		26" x 97"		49" x 97"		24.5" x 97"		49" x 97"		24.5" x 97"
Pickled Maple		57" x 97"		27.5" x 97"		49" x 97"		24.5" x 97"		49" x 97"		24.5" x 97"
Sculpted Wenge		52" x 97"		26" x 97"		49" x 97"		24.5" x 97"		49" x 97"		24.5" x 97"
Solar Oak		57" x 97"		27.5" x 97"		49" x 97"		24.5" x 97"		49" x 97"		24.5" x 97"
Summer Flame		57" x 97"		27.5" x 97"		49" x 97"		24.5" x 97"		49" x 97"		24.5" x 97"
Walnut		56" x 97"		27" x 97"		49" x 97"		24.5" x 97"		49" x 97"		24.5" x 97"
Westminster Mahogany		57" x 97"		27.5" x 97"		49" x 97"		24.5" x 97"		49" x 97"		24.5" x 97"
White Crystal		52" x 97"		26" x 97"		49" x 97"		24.5" x 97"		49" x 97"		24.5" x 97"
White High Gloss		56" x 97"		27" x 97"		49" x 97"		24.5" x 97"		49" x 97"		24.5" x 97"
White Matte		52" x 97"		26" x 97"		49" x 97"		24.5" x 97"		49" x 97"		24.5" x 97"
White Woodgrain		52" x 97"		26" x 97"		49" x 97"		24.5" x 97"		49" x 97"		24.5" x 97"

### 1/4" MDF Laminated Panels Part # 1723

- 1) Raw MDF panels (see Plywood End Panels & Sheet Goods) are laminated on two sides with foil, to avoid warping.
- 2) Panels can be ordered cut to size, with a maximum size limitation of 40"W x 90"H.
- 3) Available with all RTF foil colors.

★ 1/4" Laminated Panel Pricing: Charge for Raw MDF Panel *plus* Foil Charge (front & back) per square foot. ★



WalzCraft.com



(Phone) 1-800-237-1326 7:00AM - 4:30PM CST (24 Hour Fax) 1-608-781-3667

# MDF & RTF

*"Quality on time, every time!"*

- "Passes" refer to the number of CNC Router cycles required to complete a door. Complex doors require more "passes."
- The (F) indicates the profile options that are available for RTF foils.

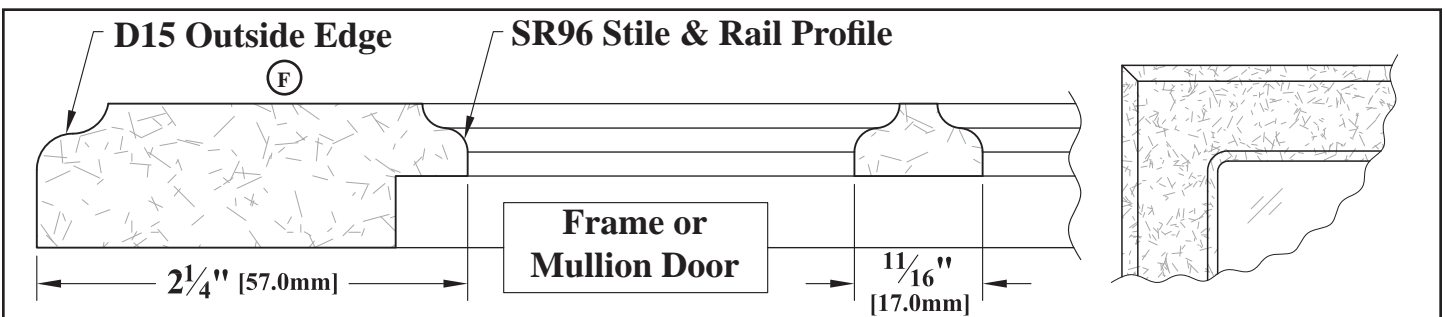
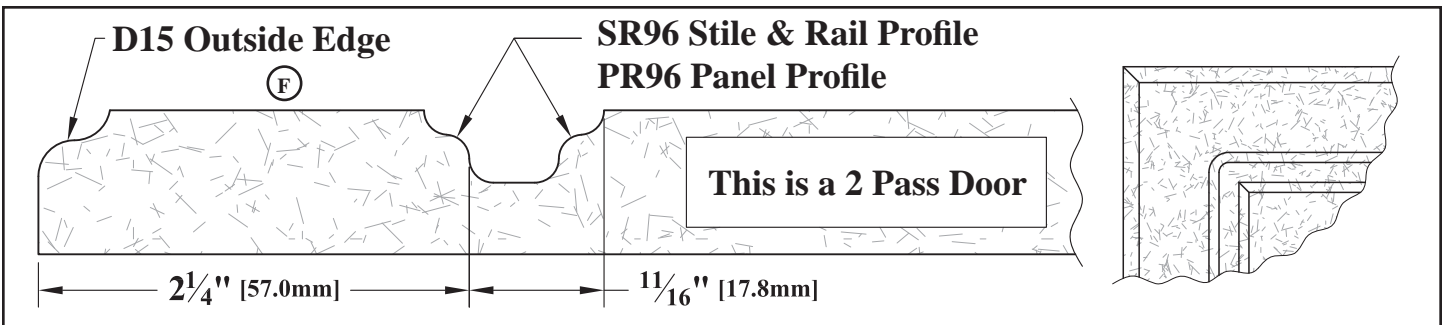
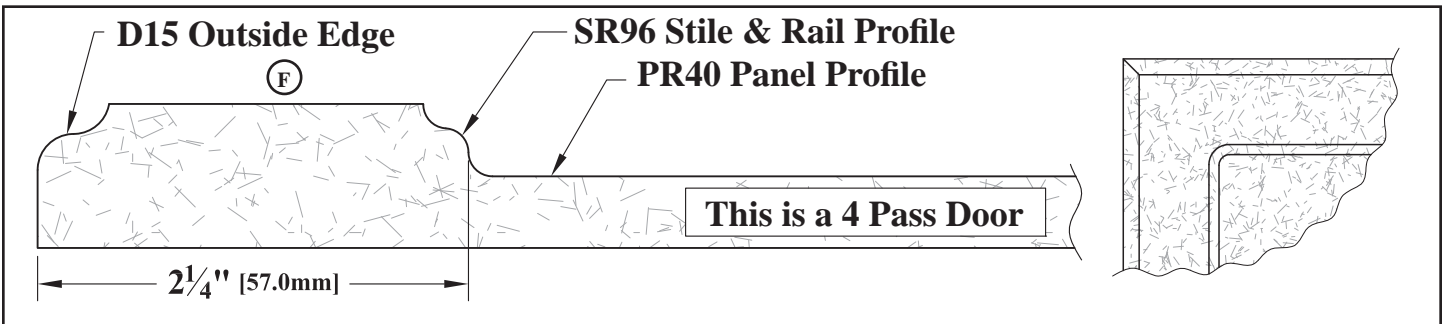
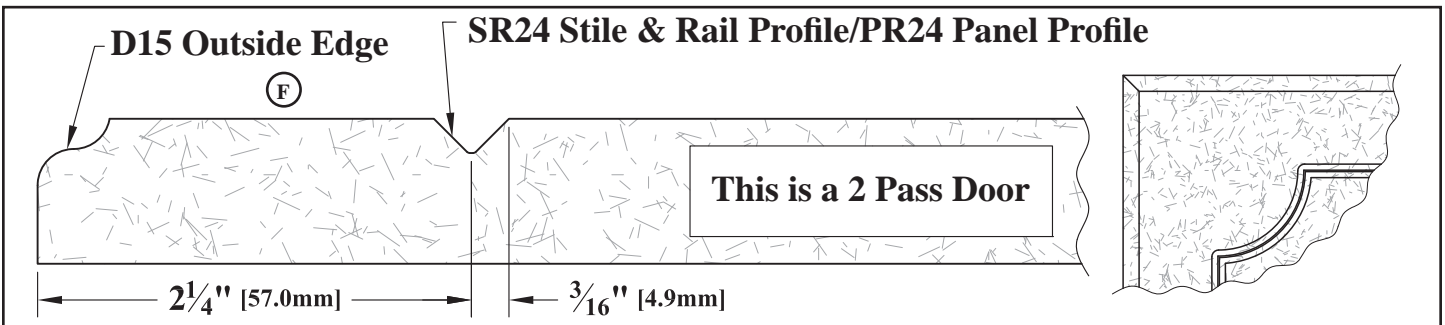

WalzCraft<sup>®</sup>.com



(Phone) 1-800-237-1326 7:00AM - 4:30PM CST (24 Hour Fax) 1-608-781-3667

# MDF & RTF

*“Try us for your Primed or SolidTone Color needs.”*

- “Passes” refer to the number of CNC Router cycles required to complete a door. Complex doors require more “passes.”
- The **(F)** indicates the profile options that are available for RTF foils.

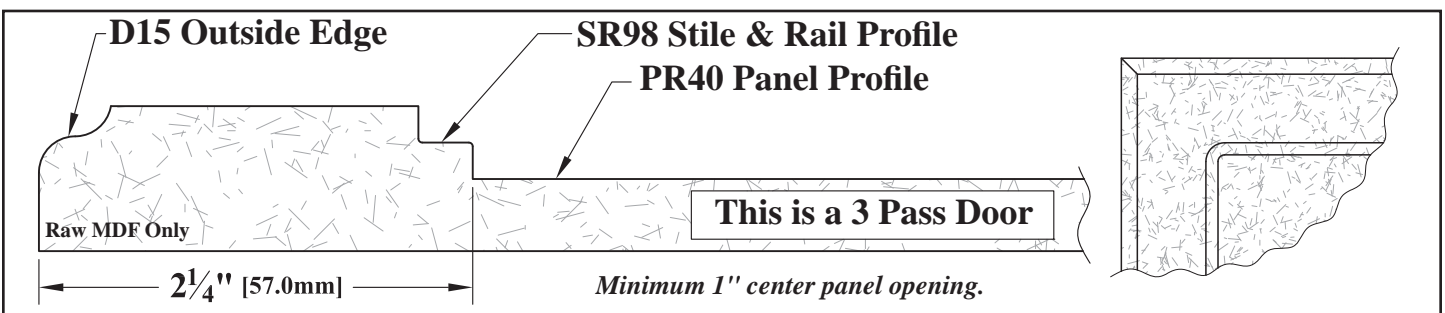
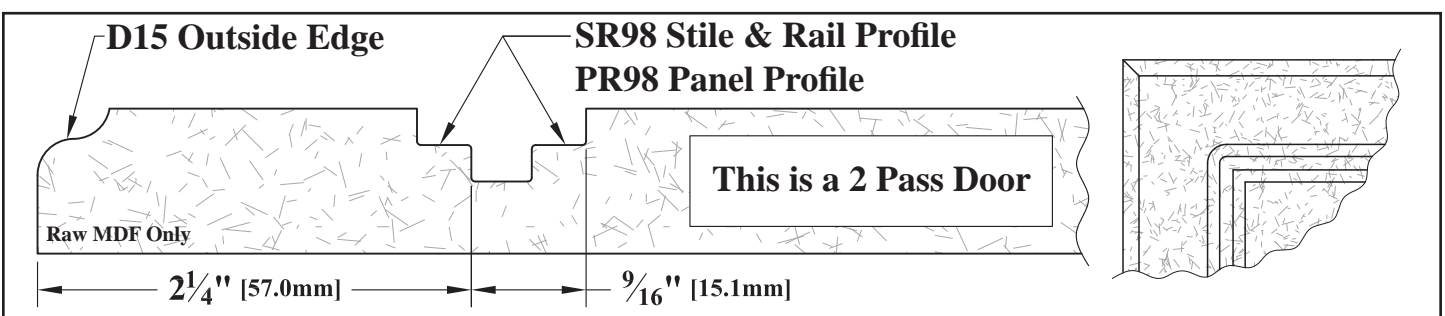
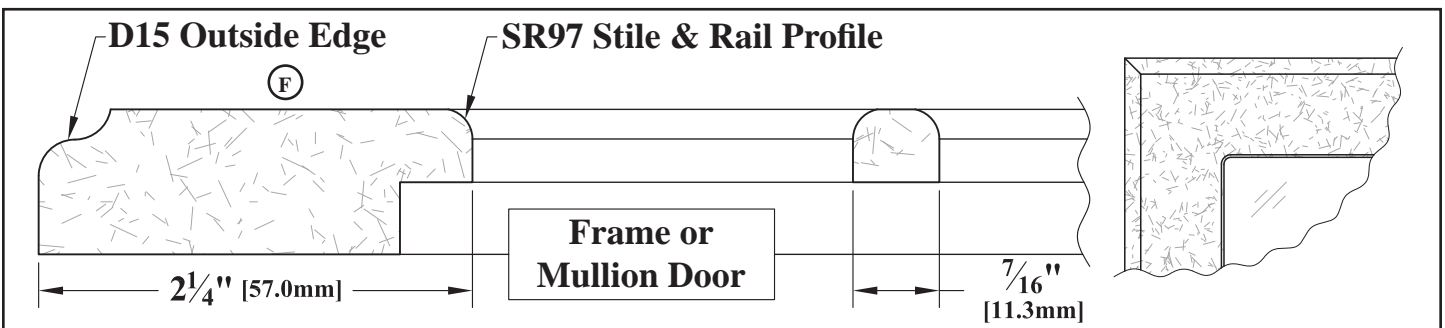
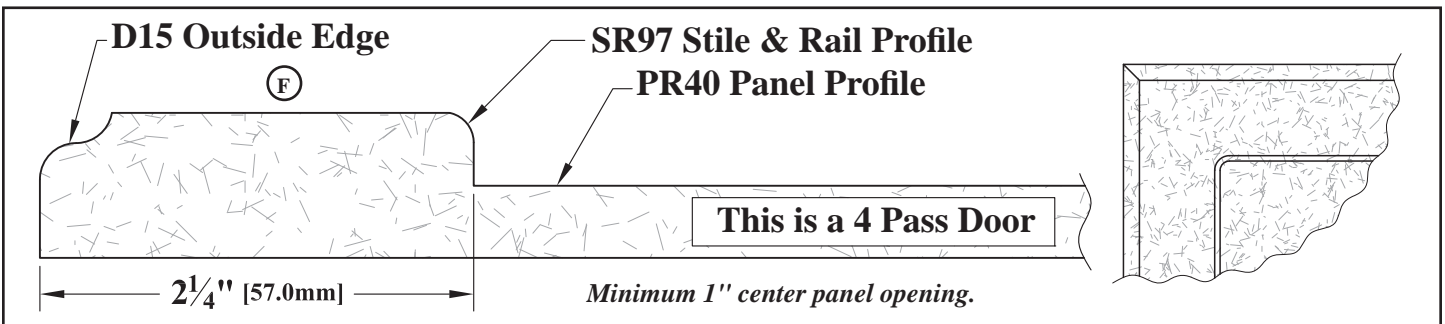
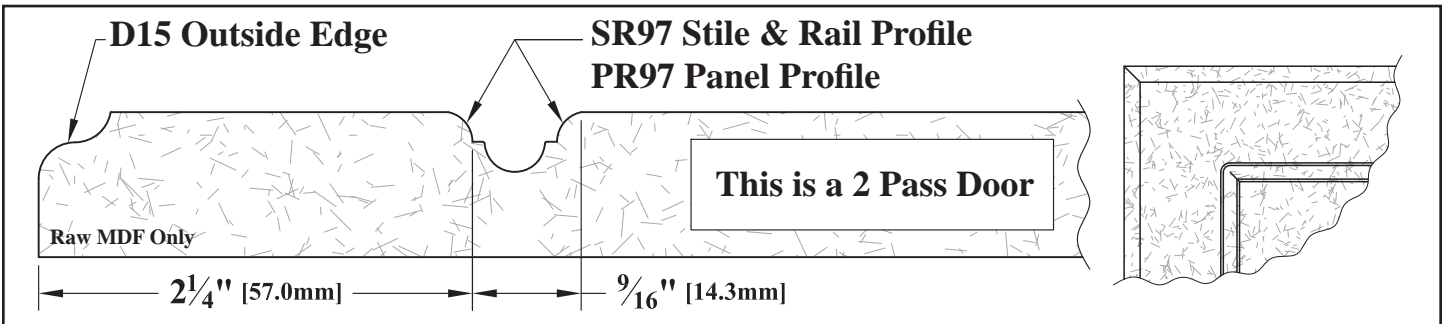

WalzCraft<sup>®</sup>.com



(Phone) 1-800-237-1326 7:00AM - 4:30PM CST (24 Hour Fax) 1-608-781-3667

# MDF & RTF

*"Glazing is available with your SolidTone color."*

- "Passes" refer to the number of CNC Router cycles required to complete a door. Complex doors require more "passes."
- The (F) indicates the profile options that are available for RTF foils.

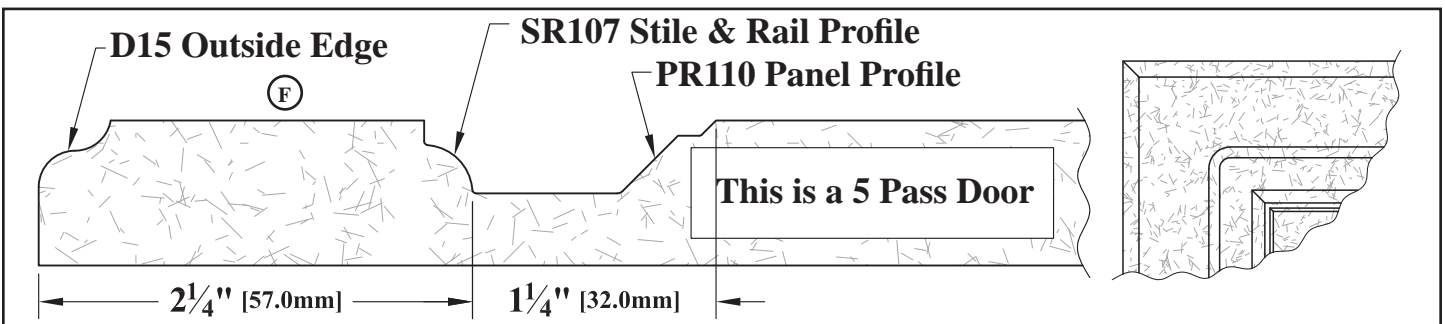
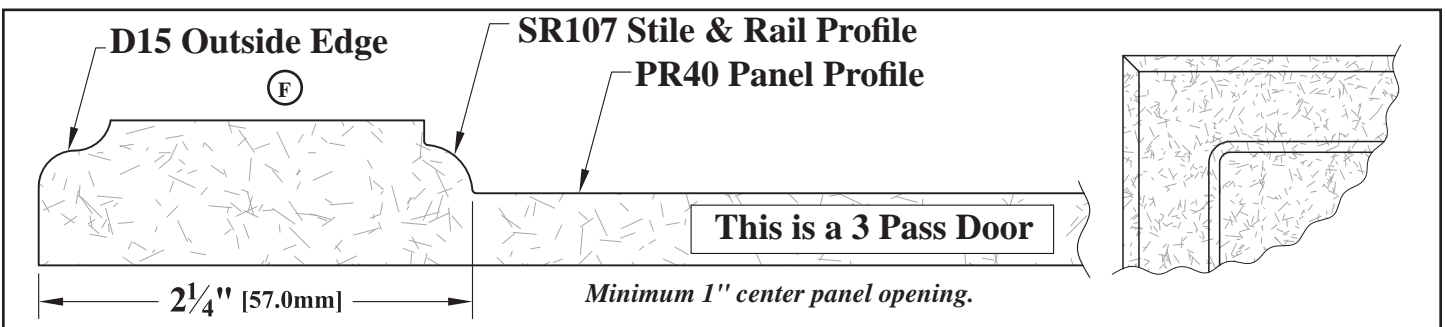
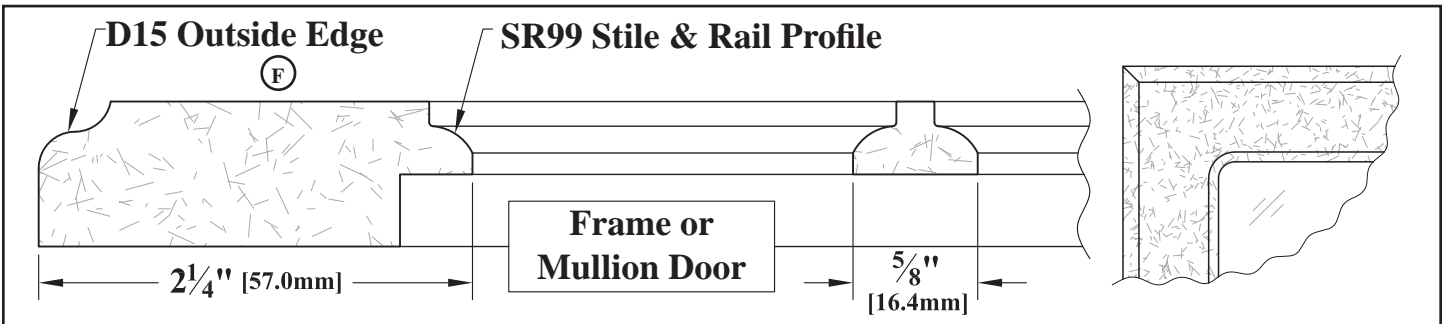
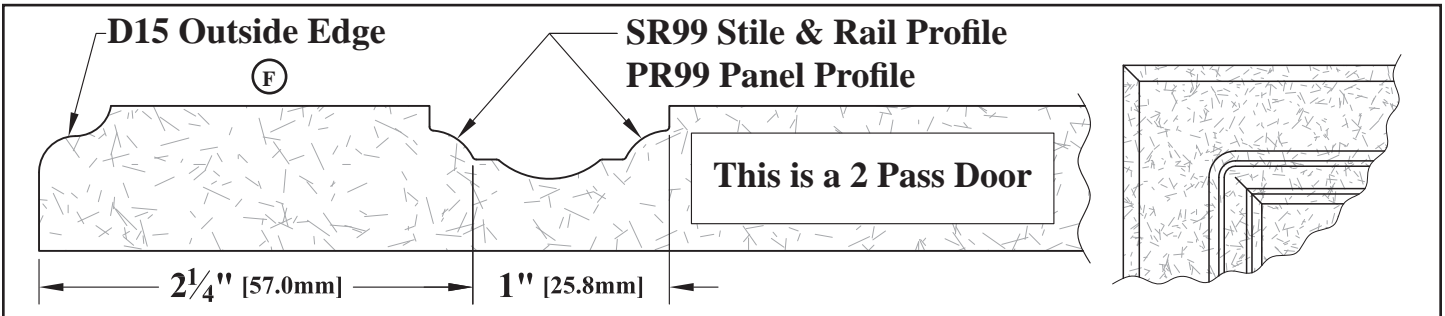
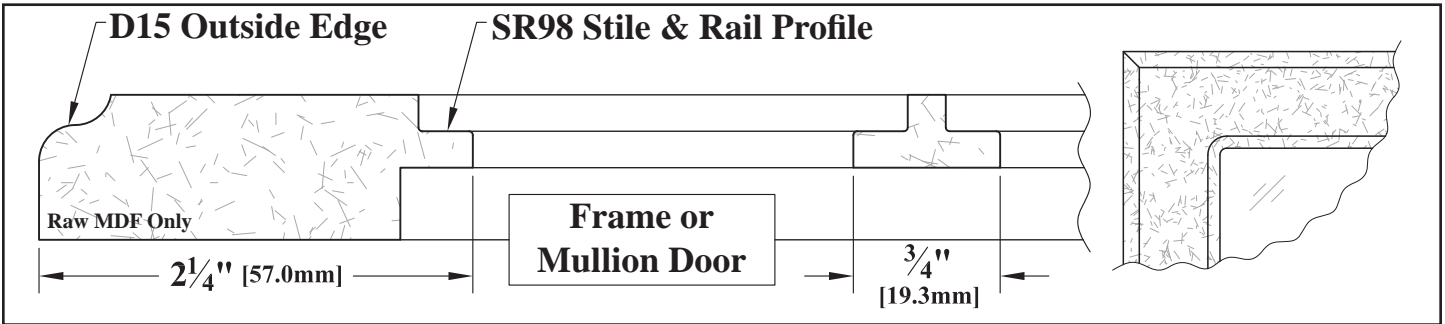

WalzCraft.com



(Phone) 1-800-237-1326 7:00AM - 4:30PM CST (24 Hour Fax) 1-608-781-3667

# MDF & RTF

*"Call for a plant tour, it is worth the trip!"*

- "Passes" refer to the number of CNC Router cycles required to complete a door. Complex doors require more "passes."
- The (F) indicates the profile options that are available for RTF foils.

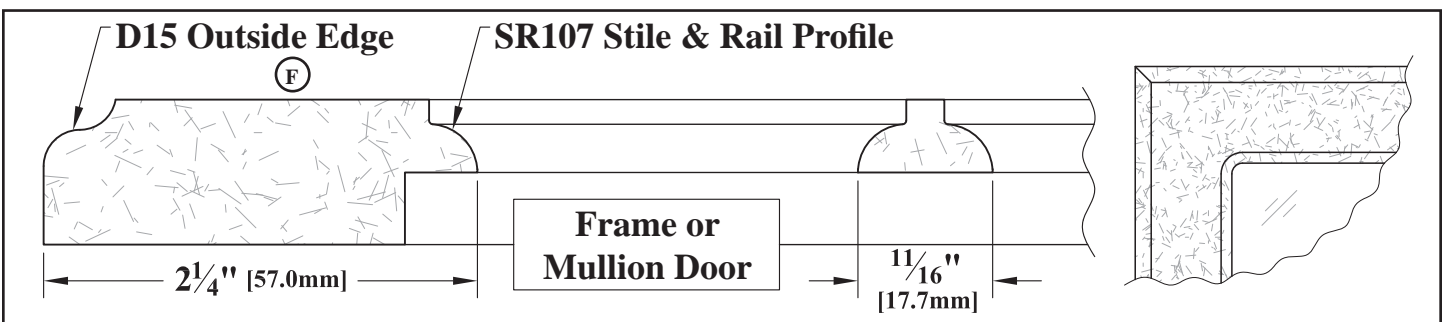
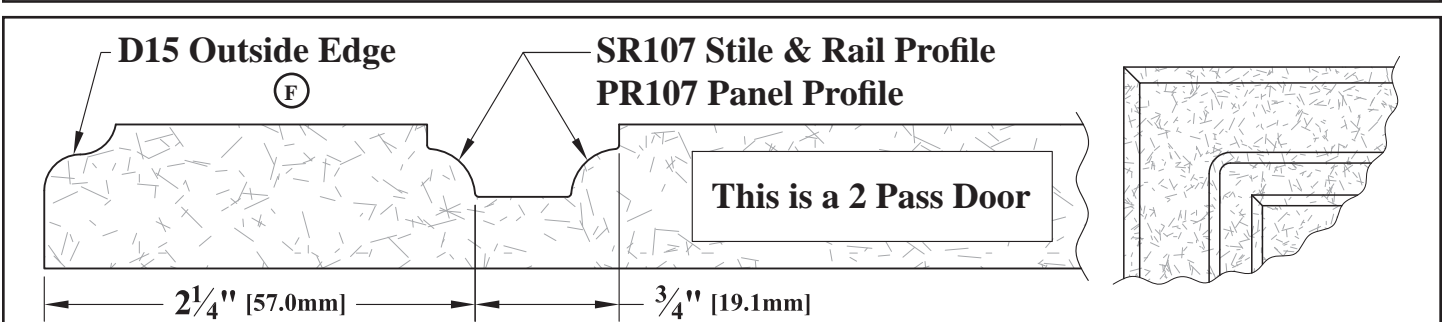
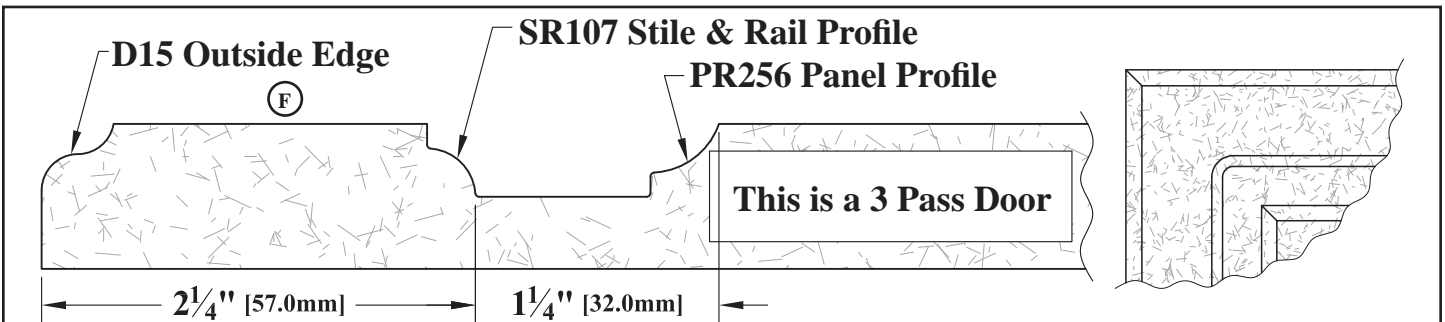
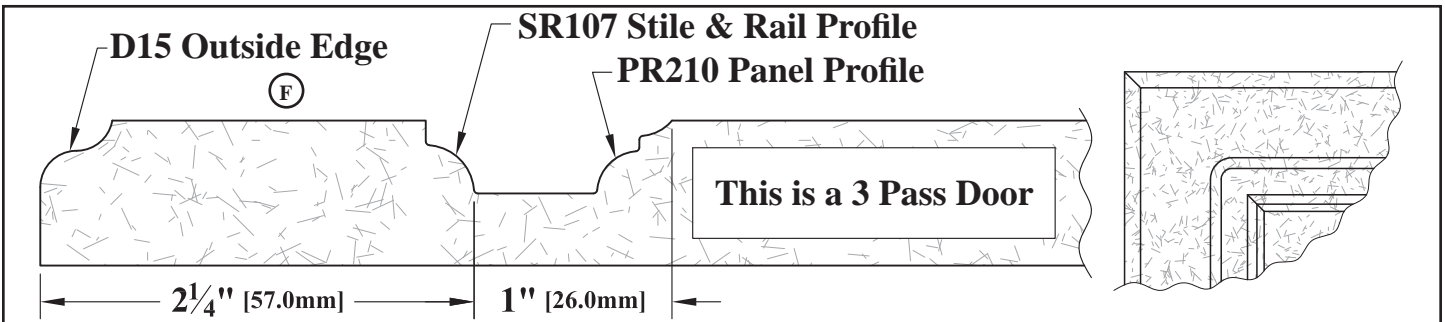
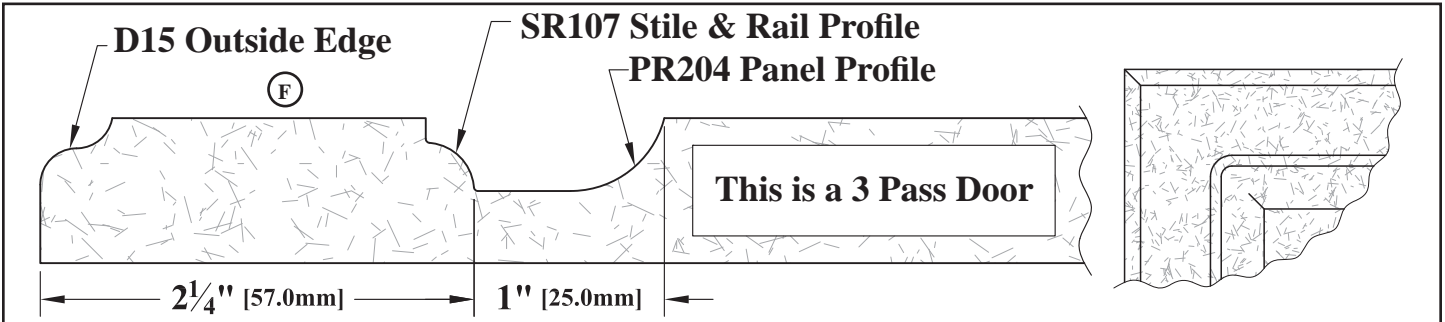

WalzCraft.com



(Phone) 1-800-237-1326 7:00AM - 4:30PM CST (24 Hour Fax) 1-608-781-3667

# MDF & RTF

*“WalzCraft, when quality is expected!”*

- “Passes” refer to the number of CNC Router cycles required to complete a door. Complex doors require more “passes.”
- The (F) indicates the profile options that are available for RTF foils.

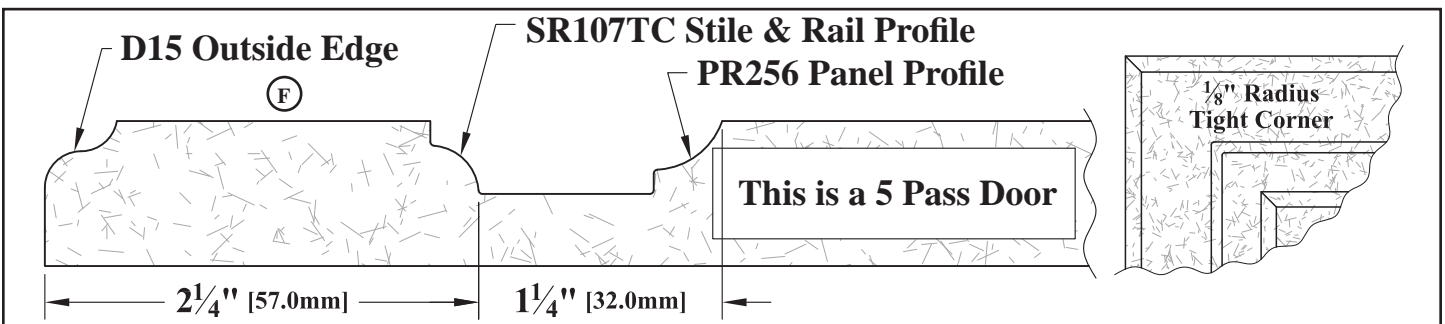
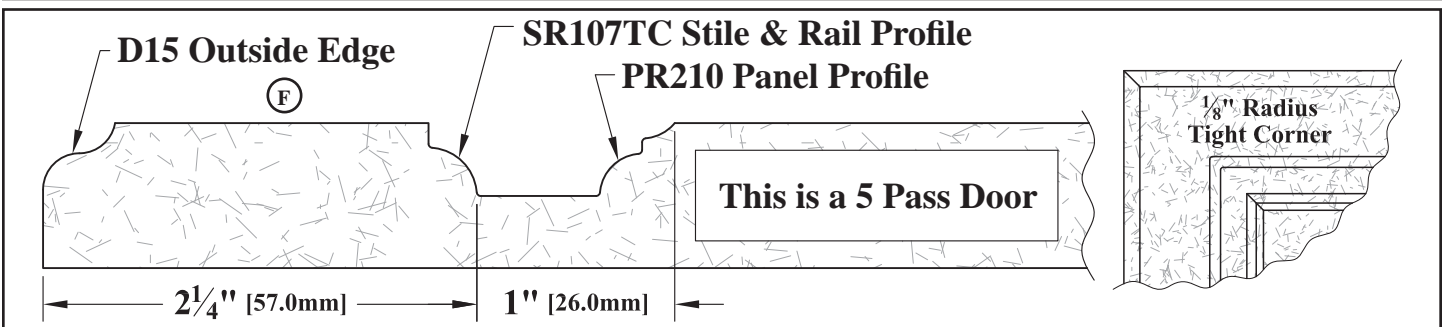
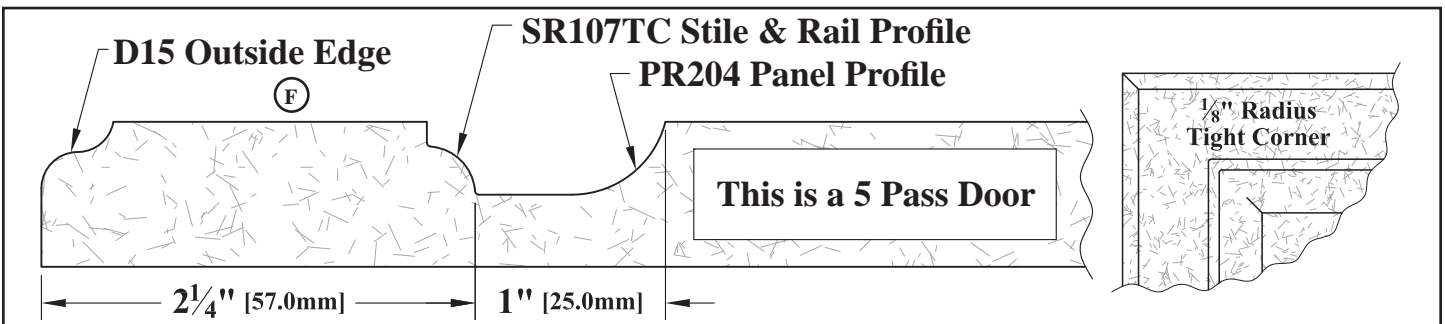
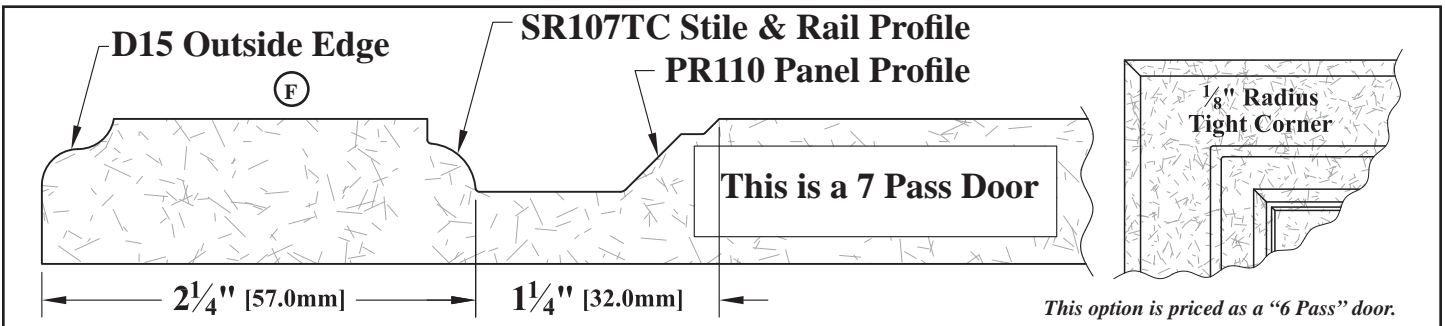
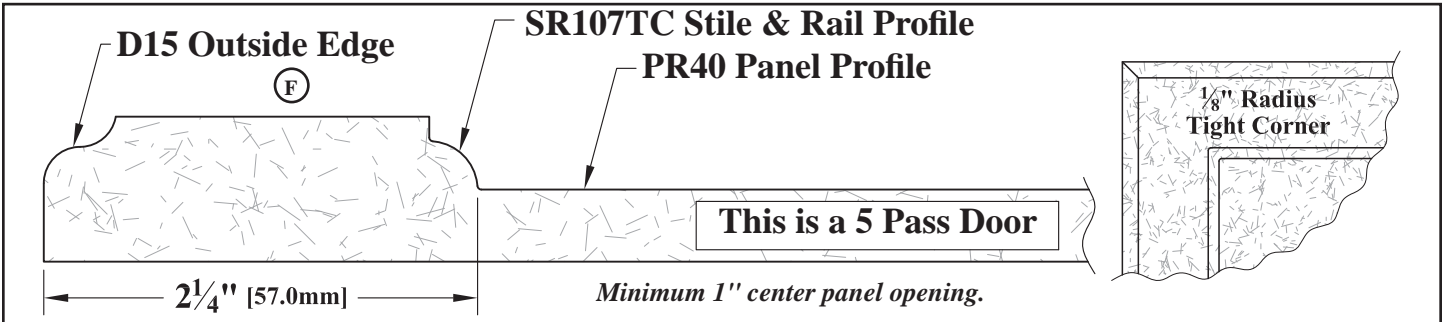

WalzCraft.com



(Phone) 1-800-237-1326 7:00AM - 4:30PM CST (24 Hour Fax) 1-608-781-3667

# MDF & RTF

*"Custom built to your specifications."*

- "Passes" refer to the number of CNC Router cycles required to complete a door. Complex doors require more "passes."
- The (F) indicates the profile options that are available for RTF foils.

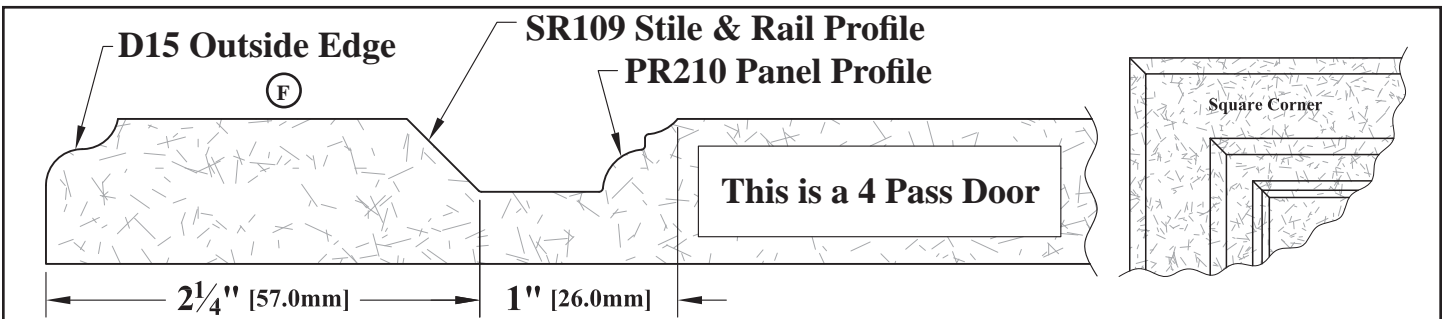
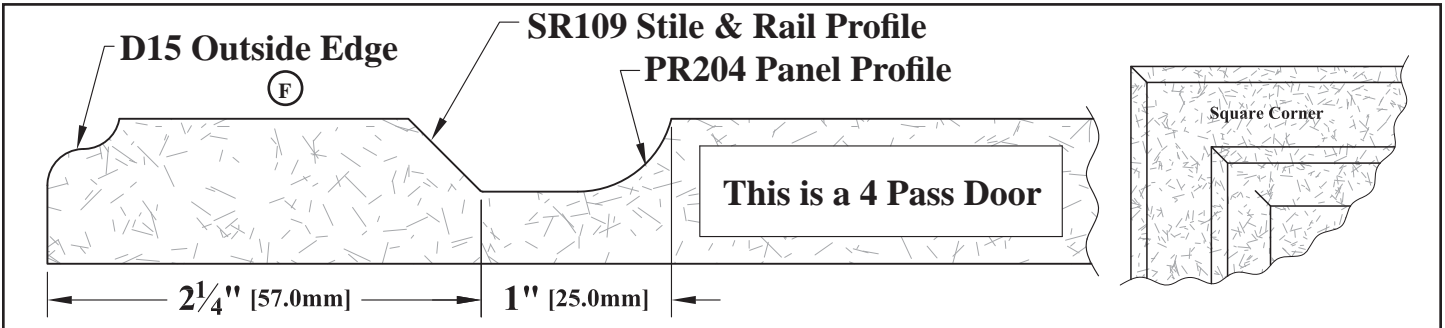
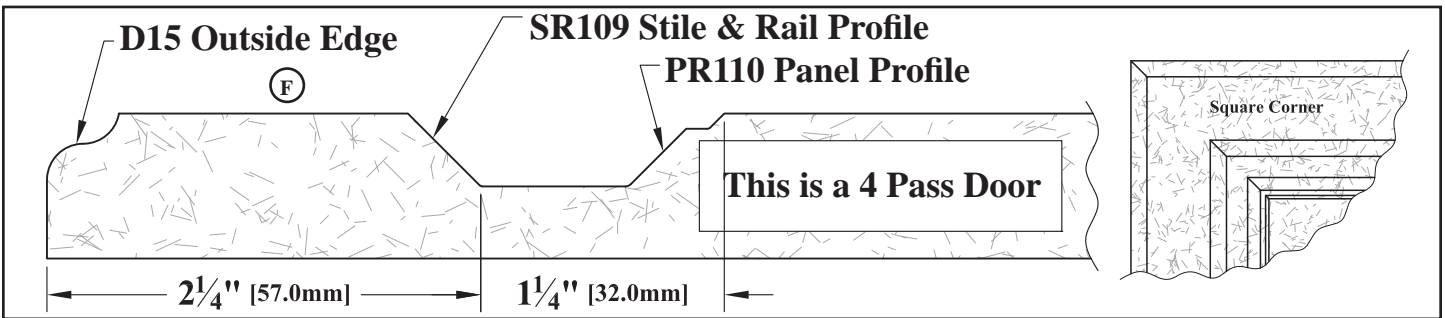
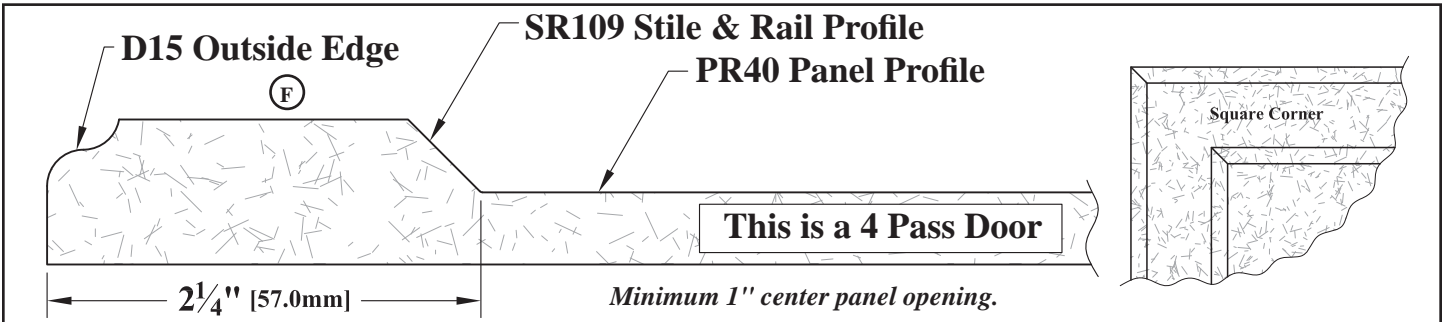
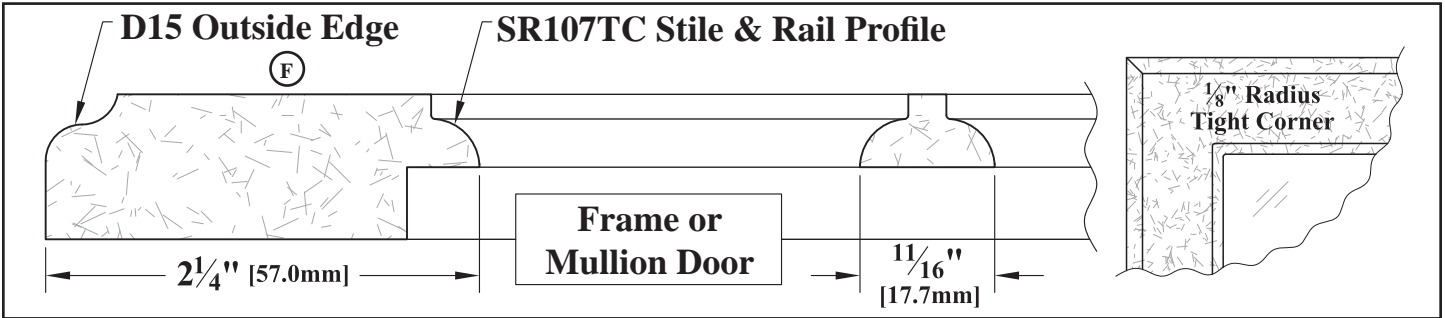

WalzCraft.com



(Phone) 1-800-237-1326 7:00AM - 4:30PM CST (24 Hour Fax) 1-608-781-3667

# MDF & RTF

*“Every door you’ll ever need, from one reliable supplier, WalzCraft!”*

- “Passes” refer to the number of CNC Router cycles required to complete a door. Complex doors require more “passes.”
- The (F) indicates the profile options that are available for RTF foils.

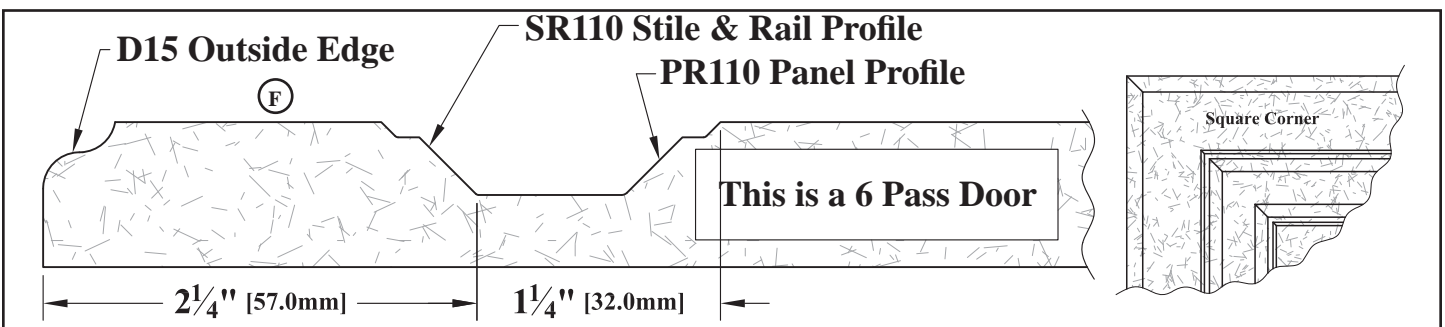
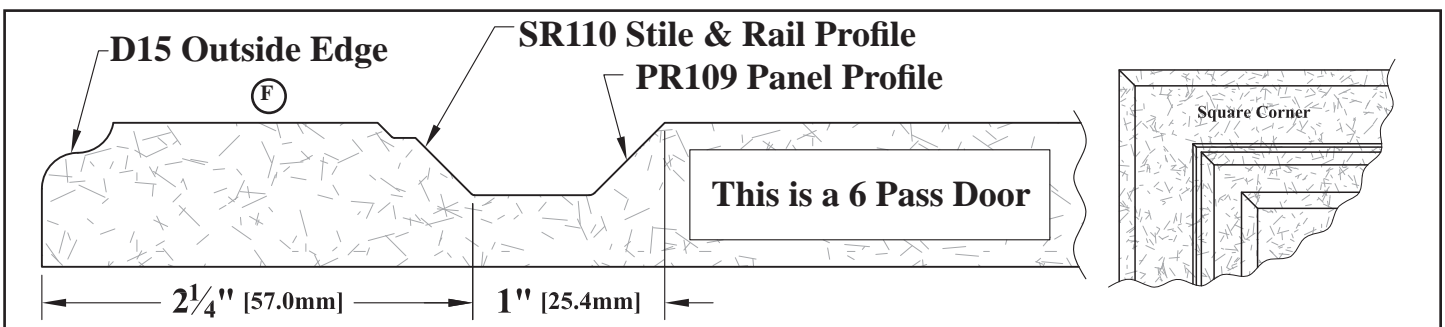
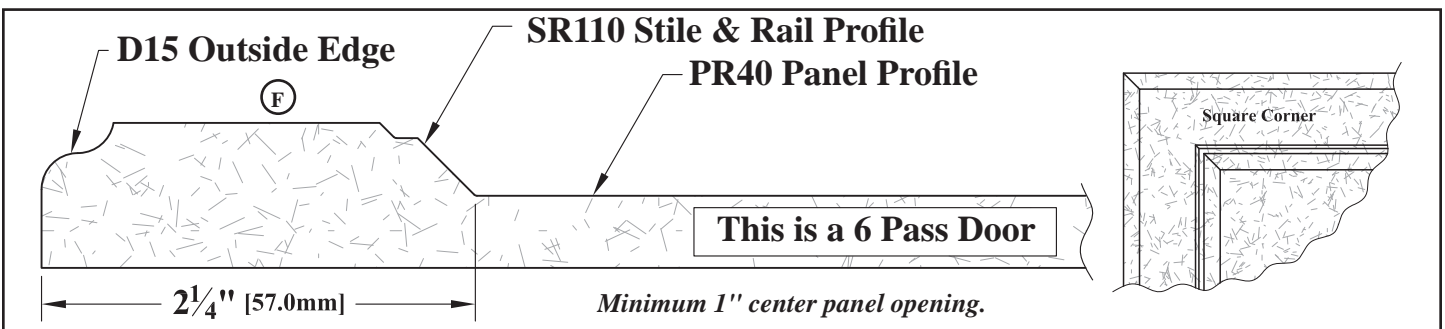
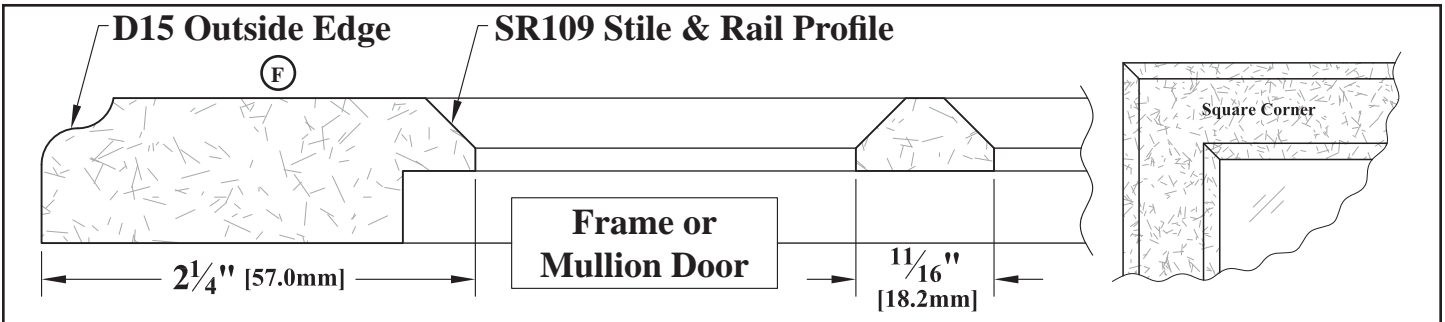
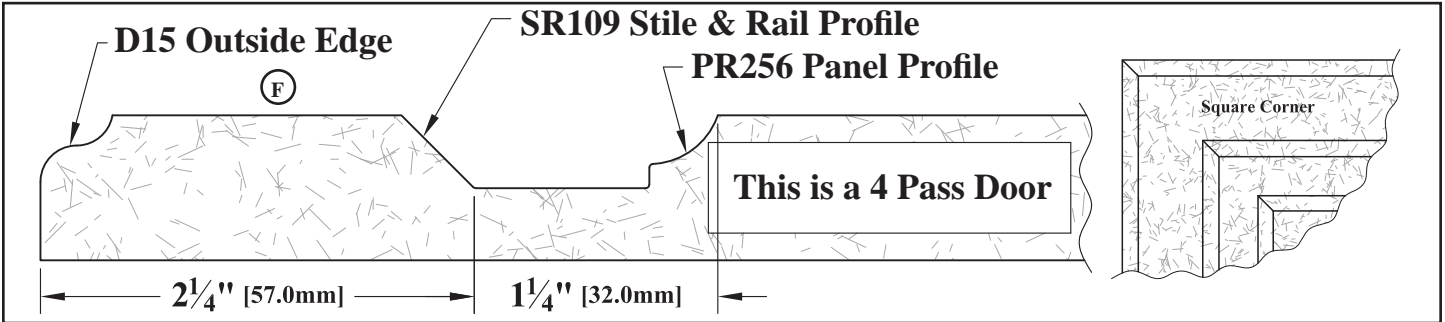

WalzCraft.com



(Phone) 1-800-237-1326 7:00AM - 4:30PM CST (24 Hour Fax) 1-608-781-3667

# MDF & RTF

*“Endless Finishing Options!”*

- “Passes” refer to the number of CNC Router cycles required to complete a door. Complex doors require more “passes.”
- The (F) indicates the profile options that are available for RTF foils.

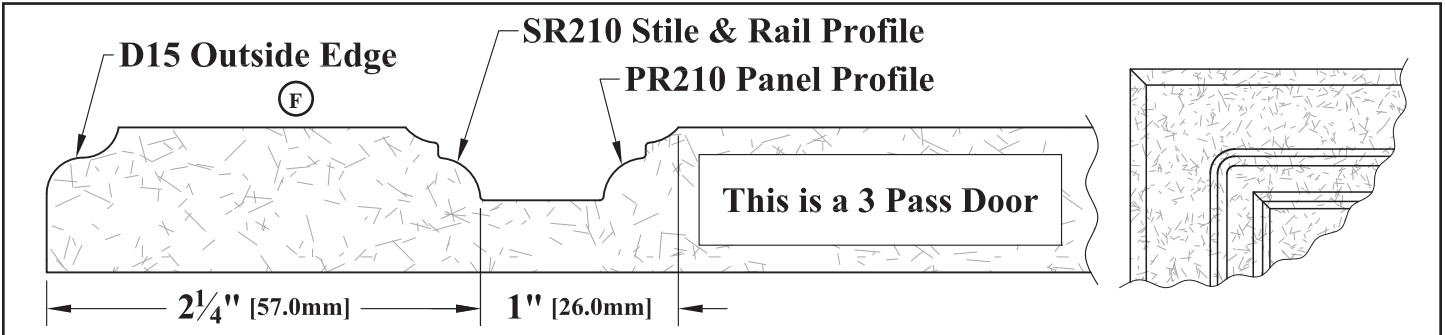
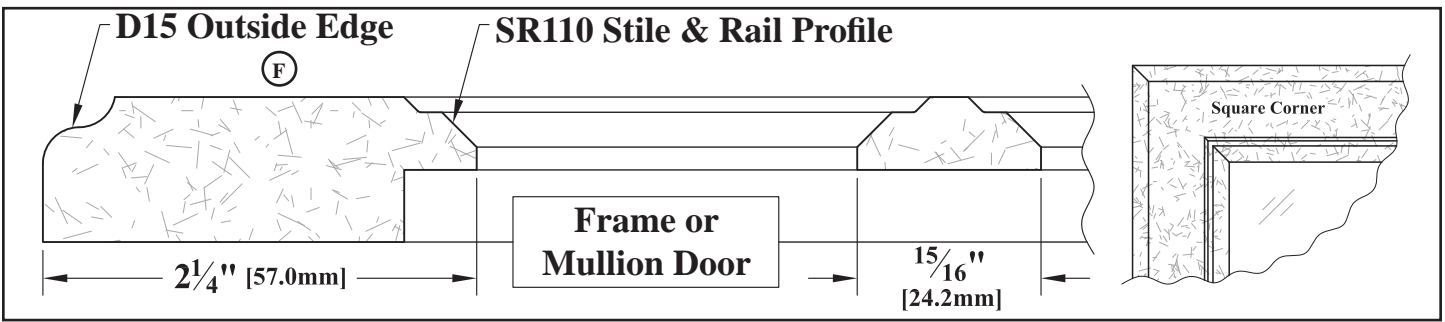
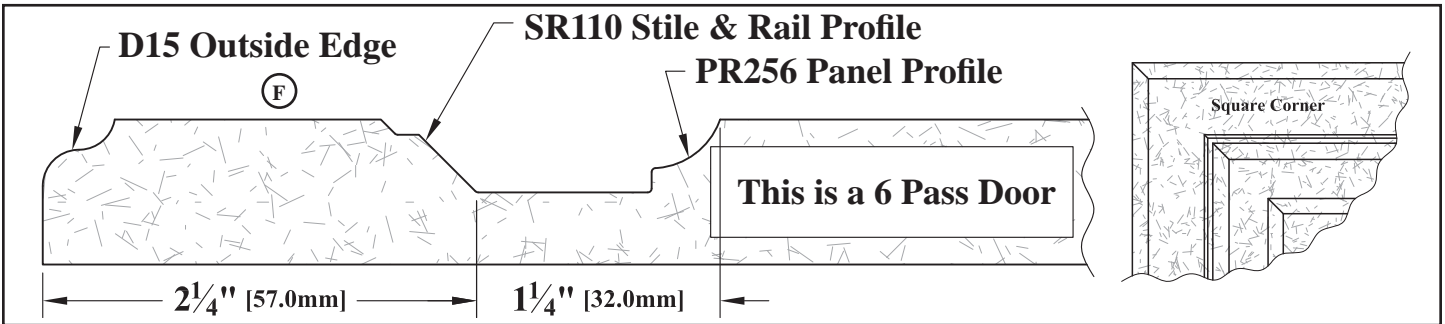
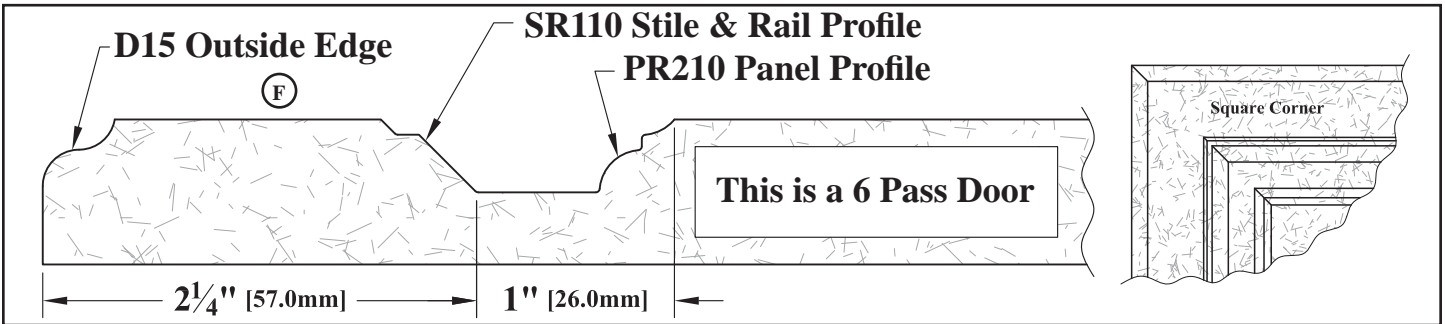
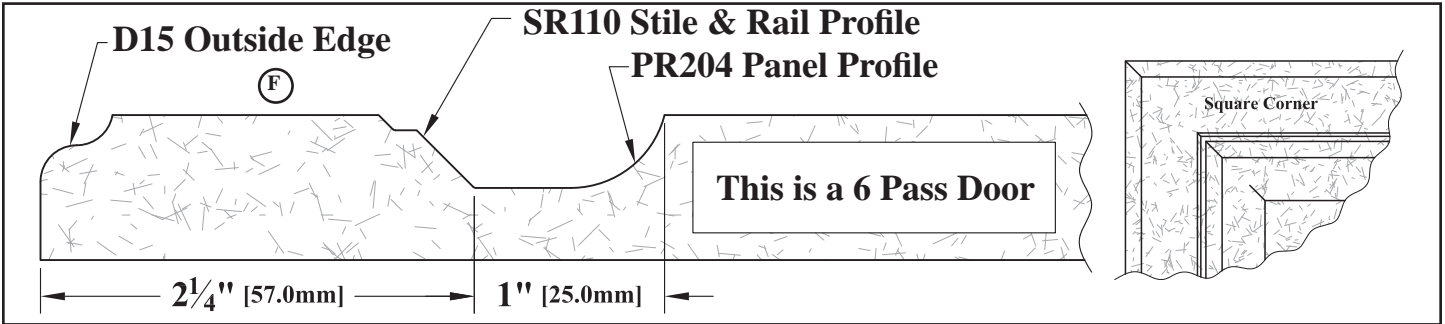

WalzCraft.com



(Phone) 1-800-237-1326 7:00AM - 4:30PM CST (24 Hour Fax) 1-608-781-3667

# 1-Piece MDF & RTF

“Visit our Web Site at [www.WalzCraft.com](http://www.WalzCraft.com).”

- “Passes” refer to the number of CNC Router cycles required to complete a door. Complex doors require more “passes.”
- The (F) indicates the profile options that are available for RTF foils.

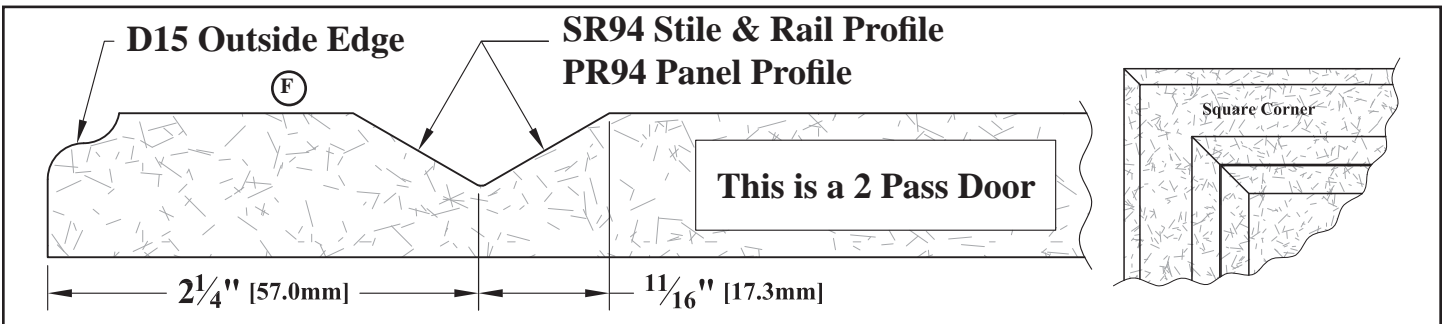
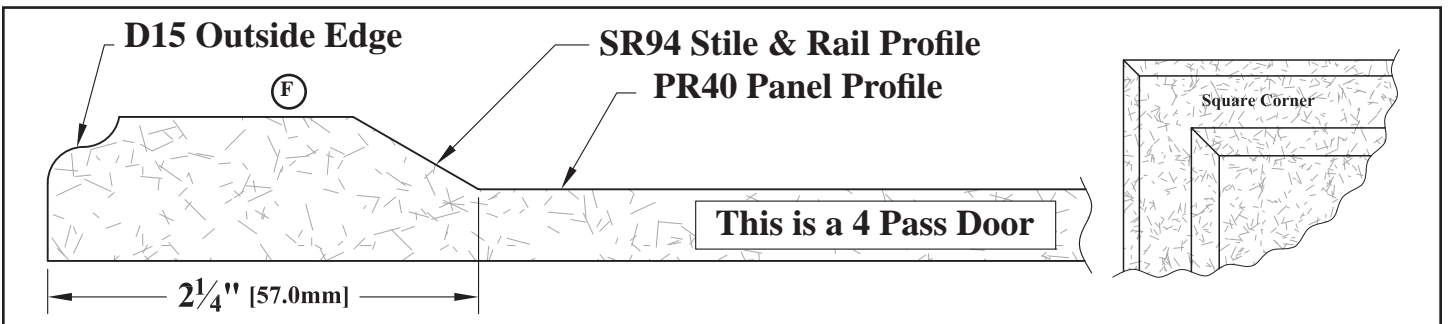
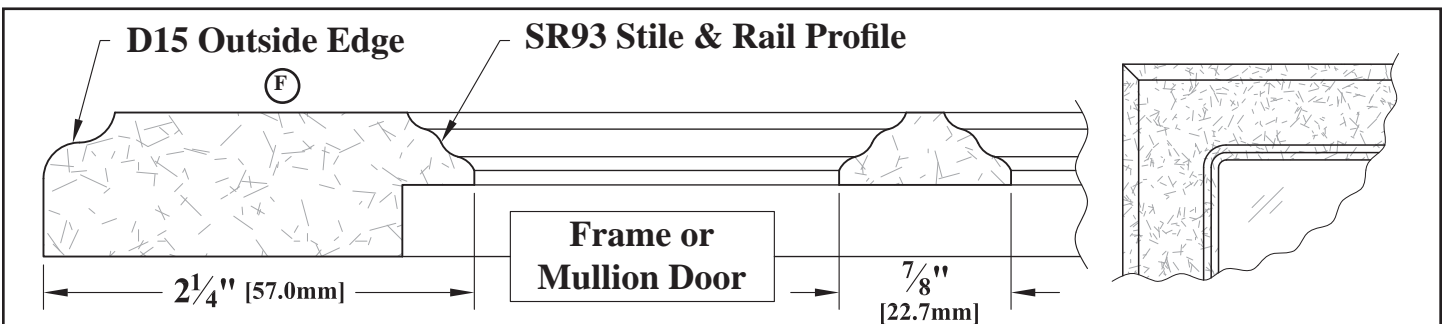
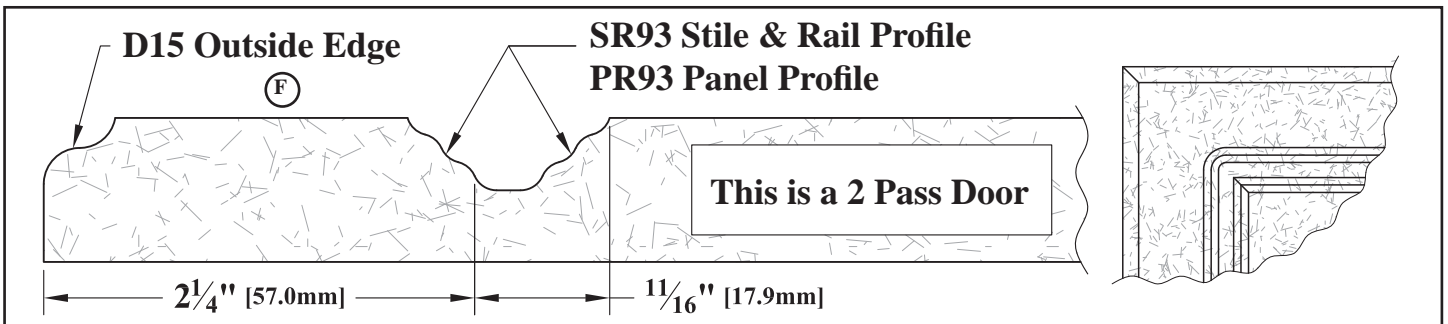
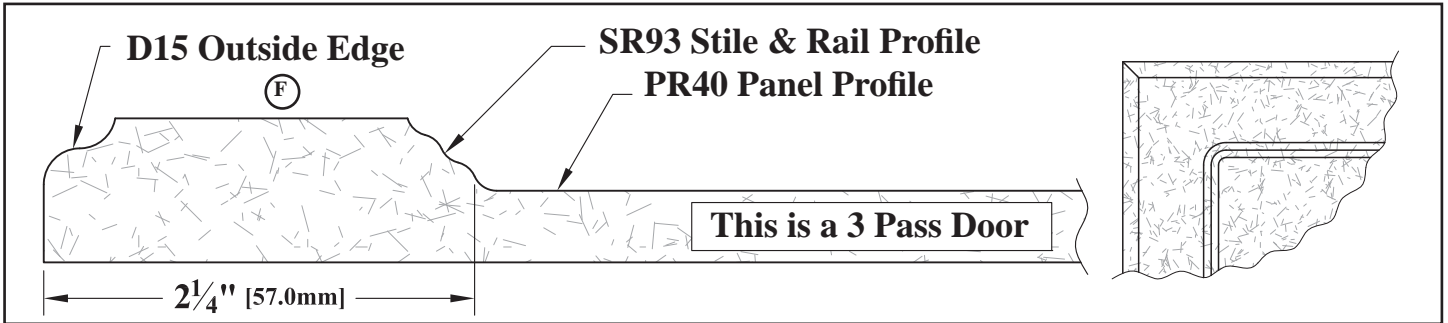

# 1-Piece MDF & RTF

*"Every door you'll ever need, from one reliable supplier, WalzCraft!"*

- "Passes" refer to the number of CNC Router cycles required to complete a door. Complex doors require more "passes."
- The (F) indicates the profile options that are available for RTF foils.

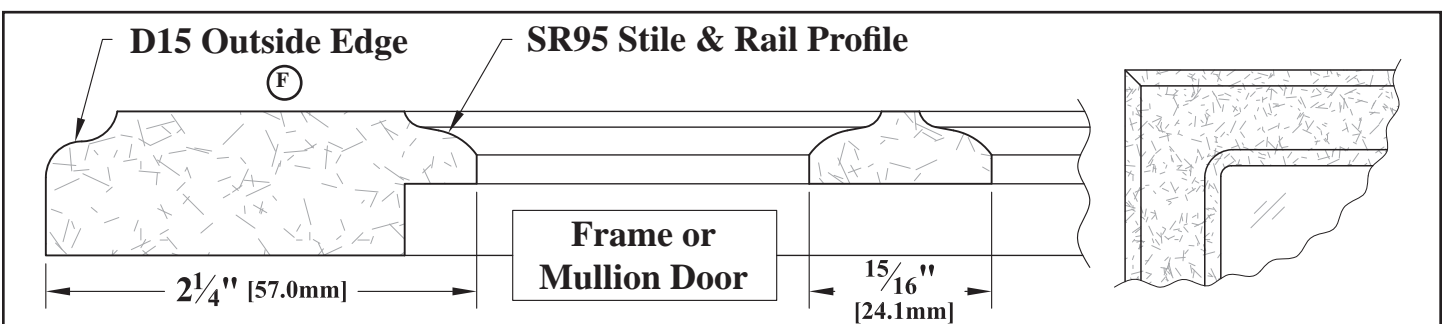
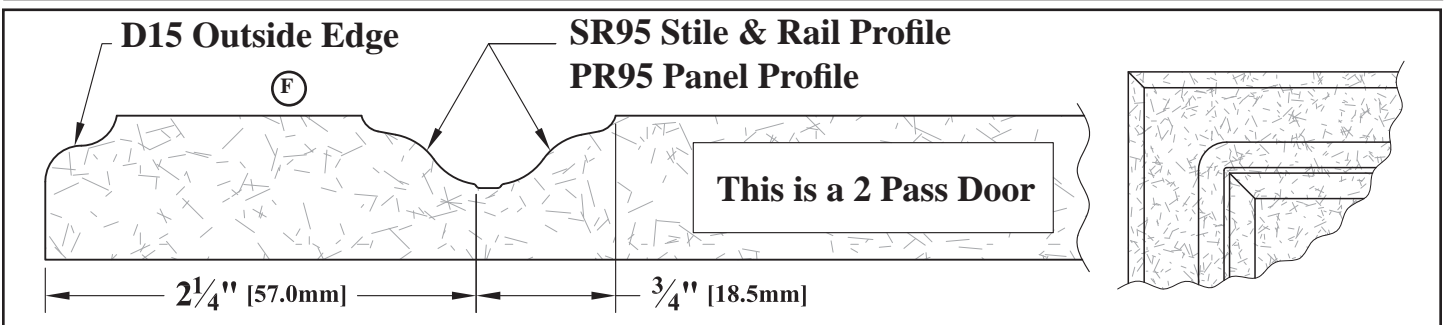
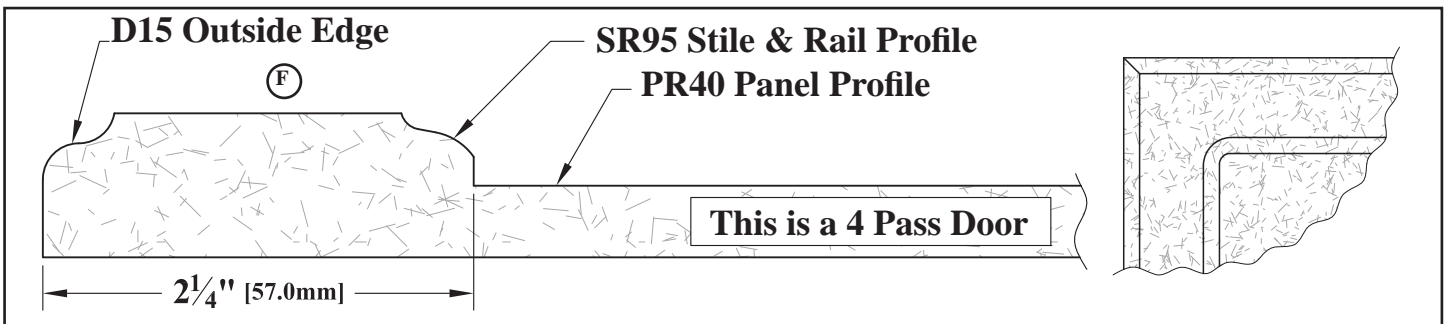
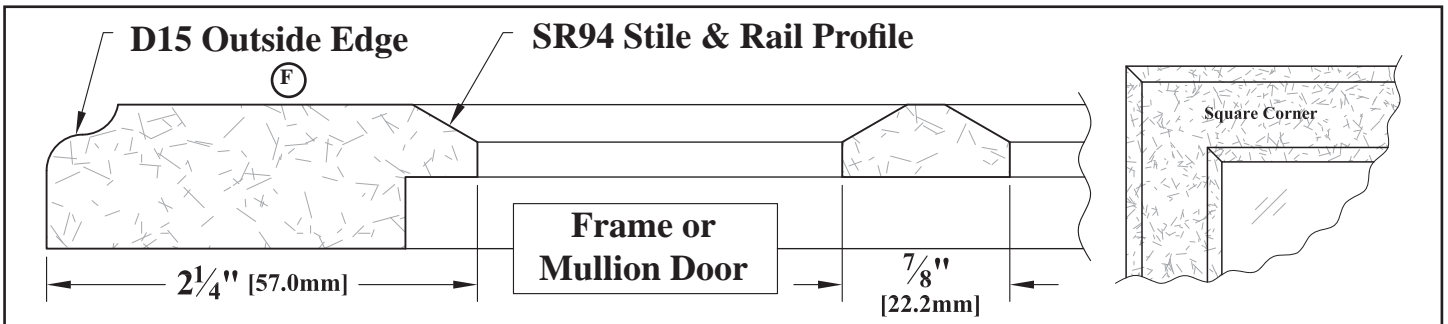
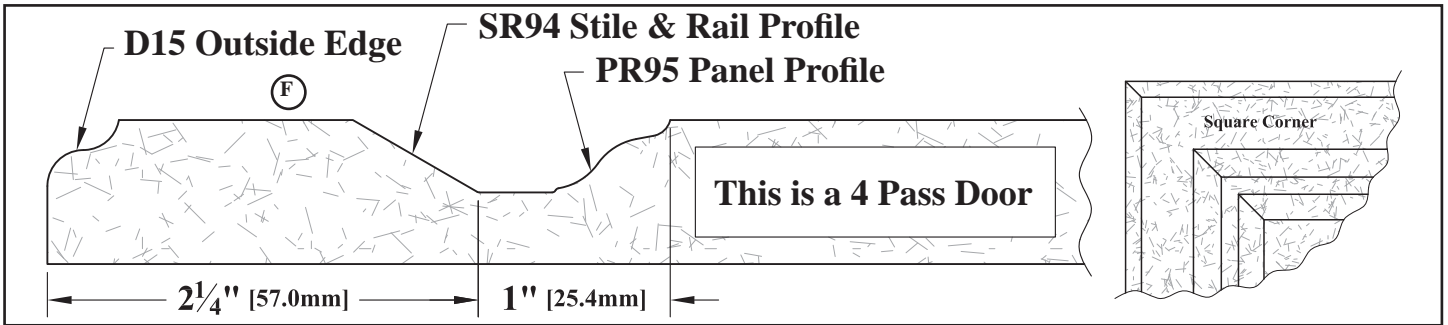

# 1-Piece MDF & RTF

*"Use our designs to create unique looks!"*

- "Passes" refer to the number of CNC Router cycles required to complete a door. Complex doors require more "passes."
- The (F) indicates the profile options that are available for RTF foils.

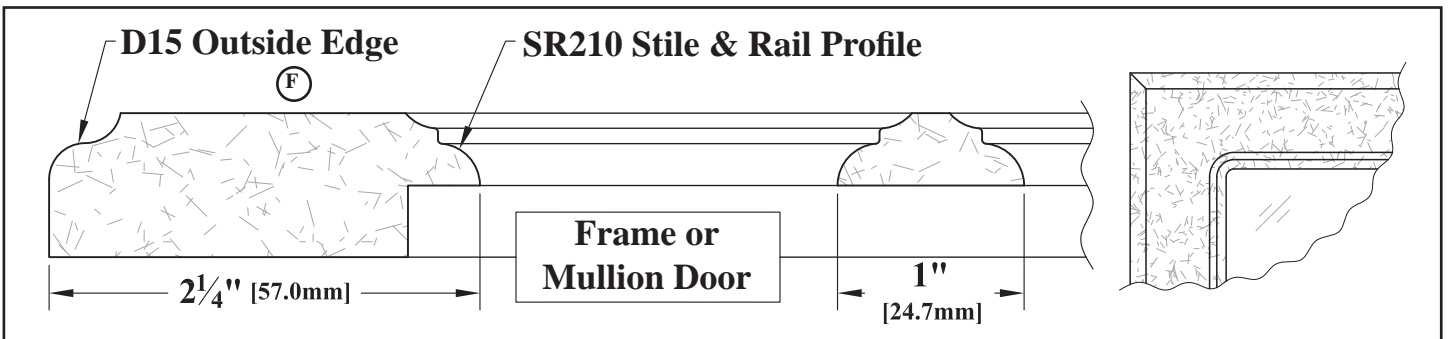
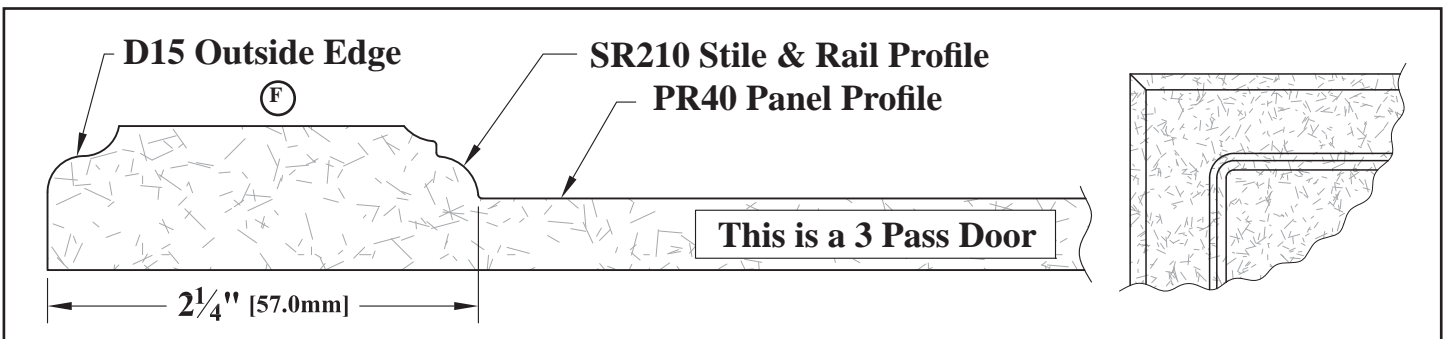
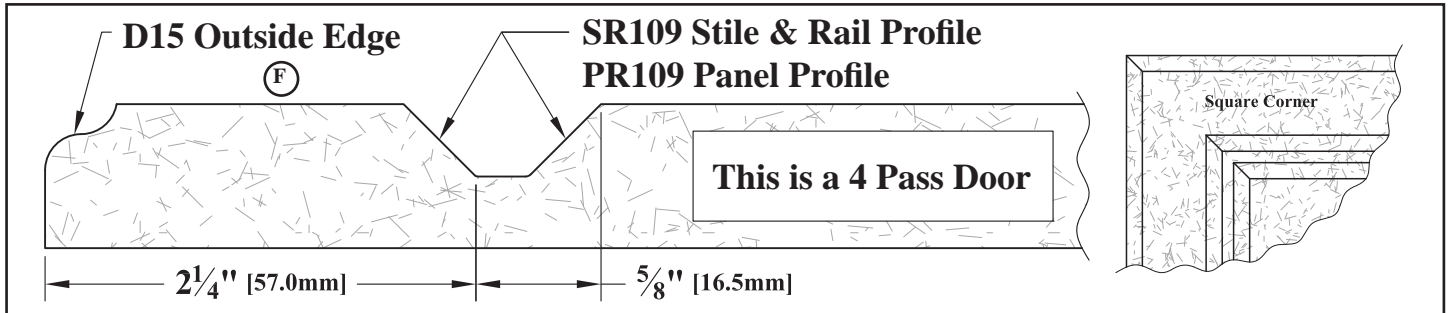

# MDF & RTF

*"Outstanding quality at competitive prices."*

## MDF & RTF Door & Drawer Fronts



**Style 500\***  
Drawer Front

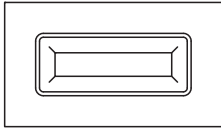

**Style 518\***  
Drawer Front  
518 shown with 2 1/4" wide top and bottom rails.

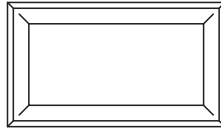

**Raised Panel**  
Drawer Front - 2 Pass

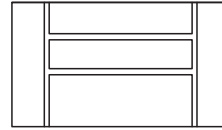

**Style 525\***  
Drawer Front

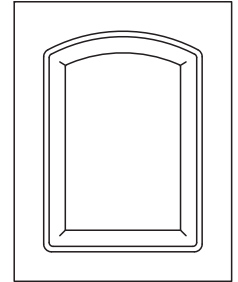

**Style 519**

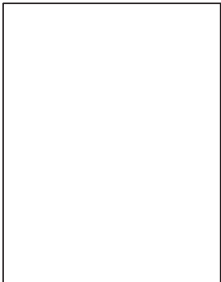

**Style 500**

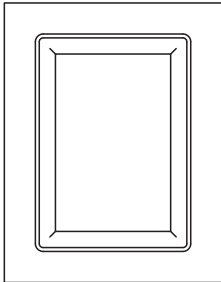

**Style 518**

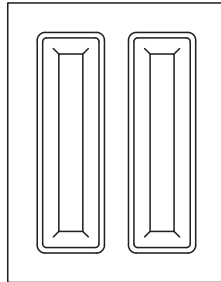

**Style 521**

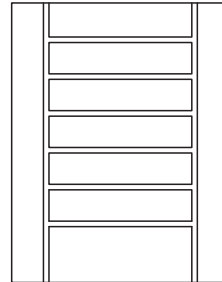

**Style 525**

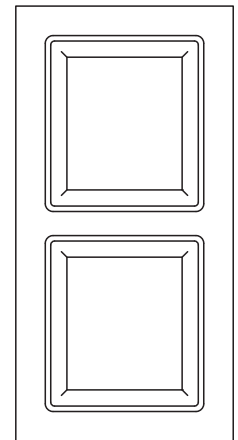

**Style 520**

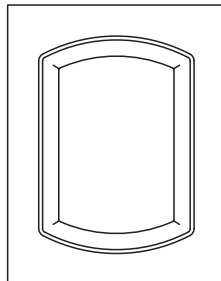

**Style 515**

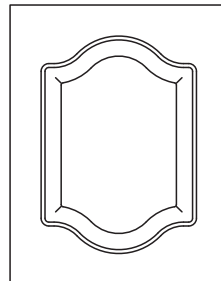

**Style 516**

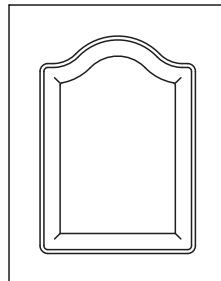

**Style 517**

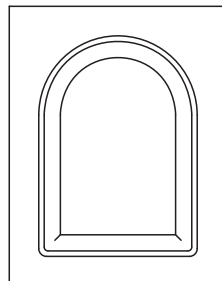

**Style 523**

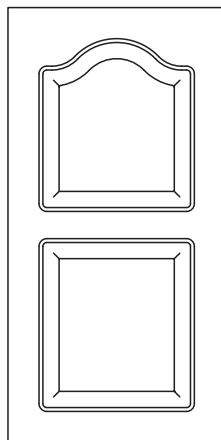

**Style 529**

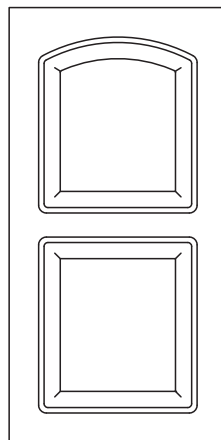

**Style 530**

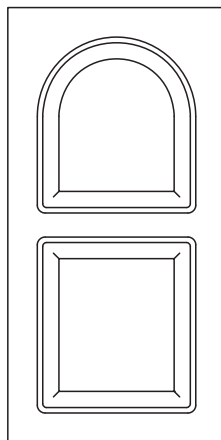

**Style 528**

### MDF & RTF Door Notes

- Minimum width, at the narrowest point, for an outside stile or rail is 1 1/4".
- Door and Drawer Front **Style 525** are only available with the **SR24/PR24** Profiles. The placement of the routing is as described in our Specification Catalog for the **Style 1025** hardwood door.
- Door and Drawer Front **Style 590** are only available with the **SR24/PR24** Profiles. The placement of the routing is as described in our Specification Catalog for the **Style 1050** hardwood door. The 590 door and drawer front do not have battens.



1" Thick Products: Add 30% to the 3/4" Square Foot Price found in our Specification Catalog.



WalzCraft<sup>®</sup>.com



(Phone) 1-800-237-1326 7:00AM - 4:30PM CST (24 Hour Fax) 1-608-781-3667

# MDF & RTF

“More design options from WalzCraft.”

## MDF & RTF Door & Drawer Fronts

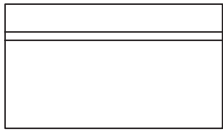

**Style 501\***  
**Drawer Front**

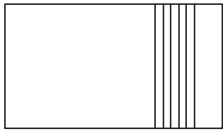

**Style 522\***  
**Drawer Front**

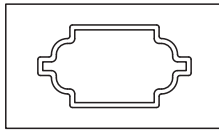

**Style 570\***  
**Drawer Front**

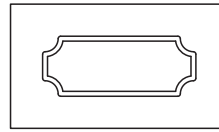

**Style 580\***  
**Drawer Front**

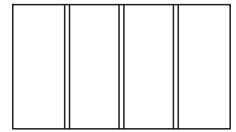

**Style 590\***  
**Drawer Front**

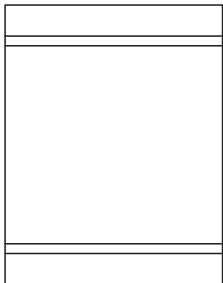

**Style 501**

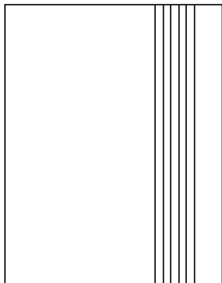

**Style 522**

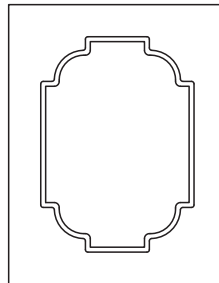

**Style 570**

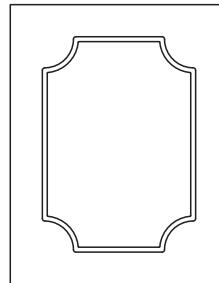

**Style 580**

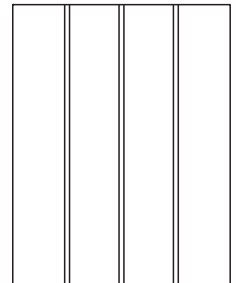

**Style 590**

The depth of the routing on the **Style 501** door is the same as that shown for the **Style 522** door. (Pictured to the right.)

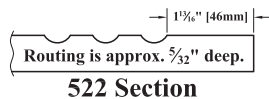

570/570\* only available with SR24/PR24. 580/580\* only available with SR24/PR24.

Hinge bores are available on the fluted side of the **Style 522** door as well as the side opposite the flutes. When ordering, please indicate which side of the door gets bored.

**590/590\*** only available with the SR24/PR24 profile.

The placement of the routing is as described in our Specification Catalog for the **Style 1050** hardwood door.

The **590/590\*** door and drawer front **do not** have battens.

★ 1" Thick Products: Add 30% to the 3/4" Square Foot Price found in our Specification Catalog. ★

## MDF & RTF Frame and Mullion Doors

Most door styles can be made as frame or mullion doors. Instructions for pricing frames and mullions are included at the bottom of this page. MDF and RTF are not available with true divided lites. The routed recessed areas on the back of RTF frame and mullion doors are painted to match the back of the door. The standard method of placement for mullions shall be to equally divide the openings. Custom placement of mullions is available, please provide a drawing for a quote.

### ★ Price Calculation for MDF/RTF Frame & Mullion Doors ★

To price a frame door in MDF, use the per square foot price listed in the “MDF Frame” row on the price grids in our Specification Catalog. In addition, if the door is a MDF mullion, add the per lite charge.

To price a frame door in RTF, use the per square foot price listed in the “MDF Frame” row on the price grids in our Specification Catalog. Add the RTF foil color upcharge to arrive at the total price per square foot.

In addition, if the door is an RTF mullion, add the per lite charge.

Note that MDF & RTF doors are not available with rubber glass retainer.



WalzCraft® .com



(Phone) 1-800-237-1326 7:00AM - 4:30PM CST (24 Hour Fax) 1-608-781-3667

# MDF & RTF

*"WalzCraft has moldings to go along with your RTF doors."*

## MDF & RTF Quarter Circle Doors

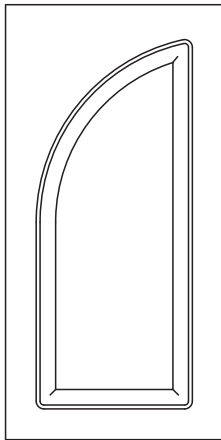

Outside Radius  
**Style 526L**

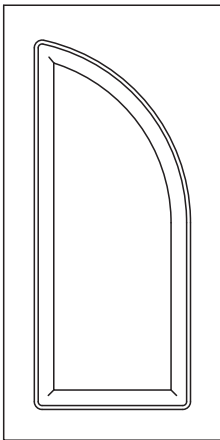

Outside Radius  
**Style 526R**

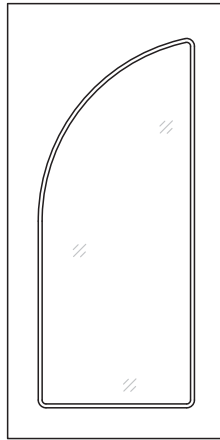

Outside Radius  
**Style 526L**  
Frame Door

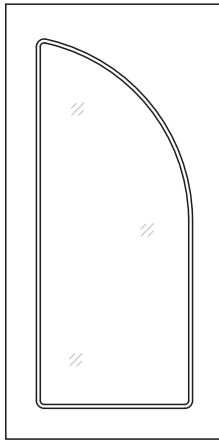

Outside Radius  
**Style 526R**  
Frame Door

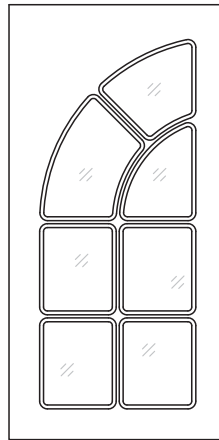

Outside Radius  
**Style 526L**  
7 Lite Mullion

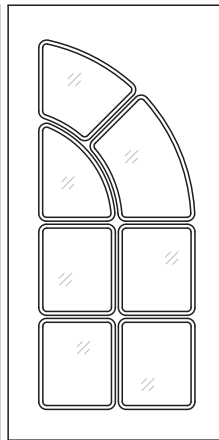

Outside Radius  
**Style 526R**  
7 Lite Mullion

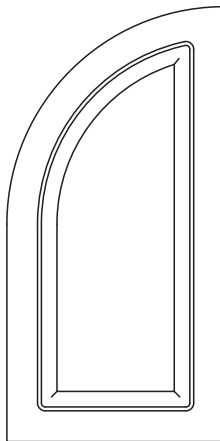

Outside Radius  
**Style 527L**

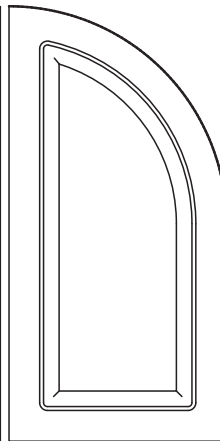

Outside Radius  
**Style 527R**

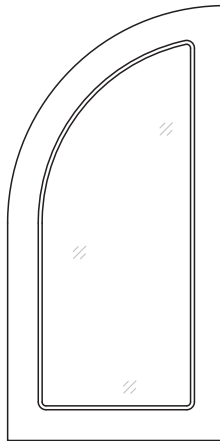

Outside Radius  
**Style 527L**  
Frame Door

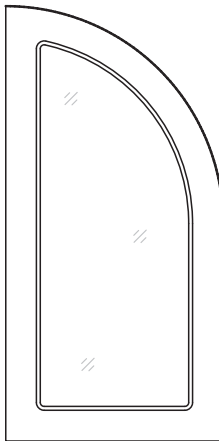

Outside Radius  
**Style 527R**  
Frame Door

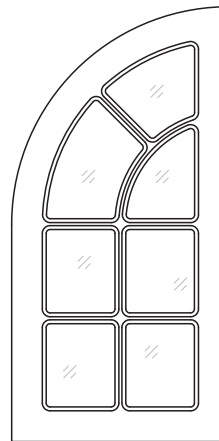

Outside Radius  
**Style 527L**  
7 Lite Mullion

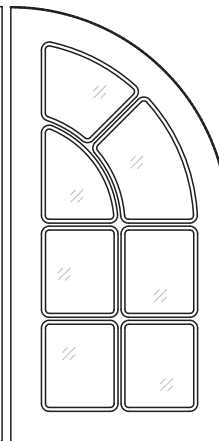

Outside Radius  
**Style 527R**  
7 Lite Mullion

★ 1" Thick Products: Add 30% to the 3/4" Square Foot Price found in our Specification Catalog. ★

### Price Calculation for Quarter Circle Doors

The prices on the chart in our Specification Catalog are square foot prices for MDF doors. To determine RTF prices you must add the appropriate upcharge for the foil color you have chosen.

When pricing mullion doors, add the per lite charge for MDF and RTF doors.



WalzCraft<sup>®</sup>.com



(Phone) 1-800-237-1326 7:00AM - 4:30PM CST (24 Hour Fax) 1-608-781-3667

# MDF & RTF

*"WalzCraft, your one source for Custom Cabinetry Components!"*

## MDF & RTF Quarter Circle Doors

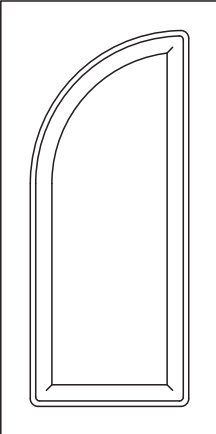
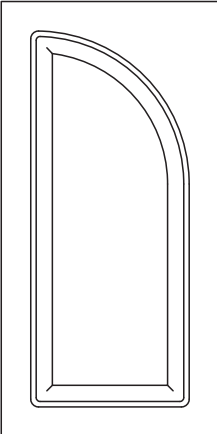
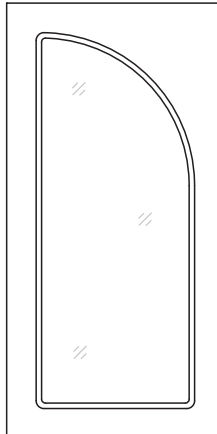
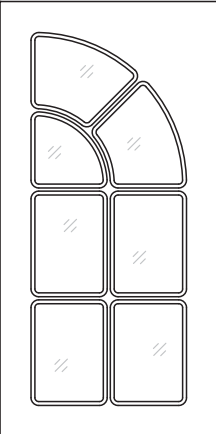
					
Inside Radius	Inside Radius	Inside Radius	Inside Radius	Inside Radius	Inside Radius
<b>Style 524L</b>	<b>Style 524R</b>	<b>Style 524L</b> Frame Door	<b>Style 524R</b> Frame Door	<b>Style 524L</b> 7 Lite Mullion	<b>Style 524R</b> 7 Lite Mullion

★ 1" Thick Products: Add 30% to the ¾" Square Foot Price found in our Specification Catalog. ★

### Price Calculation for Quarter Circle Doors

The prices on the chart in our Specification Catalog are square foot prices for MDF doors. To determine RTF prices you must add the appropriate upcharge for the foil color you have chosen.

When pricing mullion doors, add the per lite charge for MDF and RTF doors.

### MDF & RTF Notes

1)	<b>Maximum Sizes</b>	The maximum size of a MDF product is 48" x 96". The maximum size of a RTF product is 40" x 90". <b>Products with a specified grain direction that exceed 40" in width will be manufactured with Horizontal Grain.</b>
2)	<b>MDF Outside Edge Profiles</b>	All of the outside edge profiles shown on <i>pages 36-43</i> are available for MDF doors and drawer fronts. Limitations will apply for raised panel drawer fronts, see the compatibility chart on our <i>Web Site</i> . If ordering an applied molding edge on an MDF product, the applied molding will utilize a Maple-Hard-Paint/Budget wood specie.
3)	<b>RTF Outside Edge Profiles</b>	The ★ is shown on the outside edge profiles that are available with RTF.
4)	<b>Panel Opening</b>	MDF & RTF doors and drawer fronts are a one piece constructed product, if choosing a door style with a raised or flat panel, the minimum panel opening size that can be accommodated would be 1".
5)	<b>Frame &amp; Mullion Doors</b>	Due to MDF & RTF frame and mullion doors not having a GRF rout, which is standard on wood frame and mullion doors, rubber glass retainer is <i>not available</i> .



WalzCraft<sup>®</sup>.com



(Phone) 1-800-237-1326 7:00AM - 4:30PM CST (24 Hour Fax) 1-608-781-3667

# MDF & RTF

*"WalzCraft has numerous SolidTone Color Options for your MDF Doors!"*

## MDF & RTF Drawer Fronts

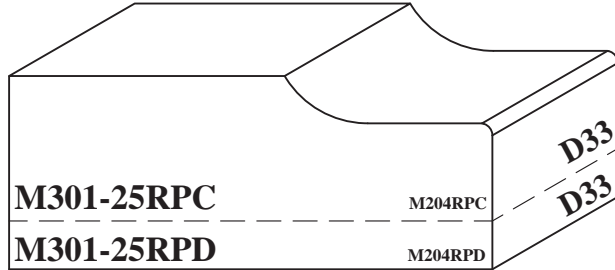
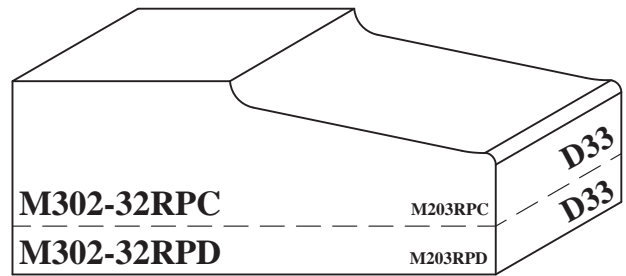
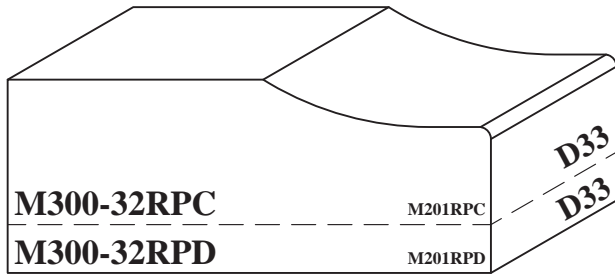

*Drawings are full scale.*

### Price Calculation for Drawer Fronts

Use the price chart from our Specification Catalog to find the square foot prices for MDF drawer fronts.

To determine RTF prices you must add the appropriate upcharge for the foil color you have chosen.

Foil upcharges can also be found in our Specification Catalog.

### MDF & RTF Drawer Front Notes

1)	<b>Drawer Front "Looks"</b>	MDF and RTF Raised Panel Drawer Fronts are available as LOOK "C" (3/4 thick) and LOOK "D" (1" thick).
2)	<b>Outside Edge Profiles</b>	Reference the compatibility chart on our <i>Web Site</i> under Technical Information to determine the outside edge profile options available for MDF and RTF drawer fronts.
3)	<b>Style 500* Drawer Fronts</b>	Style 500* drawer fronts are similar to a LOOK "A" drawer front.
4)	<b>Style 500* Drawer Front Minimum for Pricing</b>	The minimum size for a Style 500* drawer front is 3"x3". If your drawer front is below the 3" minimum required, a 2 square foot minimum per piece, for pricing will apply.
5)	<b>Applied Molding Outside Edge Options</b>	For solid wood applied molding outside edge options on Raw MDF, reference Drawer Front Notes in our Specification Catalog. To price, use Price Class Code 1001 and add the upcharge that applies.

### MDF and RTF Fluted Moldings

Fluted Moldings, #700 are offered either in MDF or in any of the RTF foil colors listed in our Specification Catalog. To order, please note the width and length of the molding, the flute size, the style of flutes (round - FMFR100 or square - FMFR200), how many flutes, your flute pattern, full length (FL) or *not* full length (NFL) and any other options that are required. Additional information can be found in our Specification Catalog. **There is a 1 square foot minimum per piece for pricing.** *RTF fluted moldings are only available with round (FMFR100) flutes.*

*The routing is approximately half the depth of the rout on a hardwood fluted molding.*



MDF and RTF Fluted Moldings are priced by the Square Foot.



WalzCraft.com



(Phone) 1-800-237-1326 7:00AM - 4:30PM CST (24 Hour Fax) 1-608-781-3667

# MDF & RTF

*"WalzCraft, when quality is expected!"*

## MDF & RTF Accessories

All of the following options are available for our MDF and RTF doors and drawer fronts.

### Hinge Boring/Dadoing/Slotting

Information on Hinge Boring, Hinge Dadoing and Hinge Slotting can be found in our Specification Catalog.

### Fingerpulls

The **FP100** finger pull options is available on all  $\frac{3}{4}$ " or 1" MDF and RTF doors and drawer fronts. The **FP200** is *not* an option on  $\frac{3}{4}$ " MDF and RTF Drawer Front styles **M300-32RP**, **M301-25RP** and **M302-32RP**. White High Gloss thermofoil is also *not* an option for  $\frac{3}{4}$ " or 1" thick MDF doors or drawer fronts with the FP200 finger pull option.

### Butt Doors

Information on Butt Doors can be found in our Specification Catalog.

### Radius Corners

Information on Radius Corners can be found in our Specification Catalog.

### 45 Degree Lazy Susan Doors

RTF doors with a mitered lazy susan configuration will look like the drawing shown in our Specification Catalog, where the back corners are clipped. In order to facilitate the pressing operation, the mitered doors do not come to a sharp point. Lazy susan doors will come to you  $\frac{1}{16}$ " smaller in width than the size you ordered. When you assemble the pair, the size will be correct because you are matching up the inside corners.

### Bread Boards

For RTF, please add the charge per bread board for painting the front wood edge, for a close match to the RTF foil color.

### Appliance Panels

WalzCraft offers **Style "A"** and **Style "C"** appliance panels in MDF or RTF.

### Center Panel Face Routing

MDF **Style 500** Doors and Drawer Fronts are available with all Center Panel Face Routing options shown in our Specification Catalog. RTF **Style 500** doors and Drawer Fronts are *only available* with **CPFR100**, **CPFR500** or **CPFR600**.

### Valances

Valances are available in MDF or RTF and are shown . When using woodgrain RTF, please specify the wood grain direction. If ordering RTF, please specify the laminate color for the back (white or almond). MDF and RTF options are not available in 1" thickness.

### Knick Knacks

Knick Knack shelves are available in MDF or RTF and are shown . When ordering knick knack shelves, the grain, if present will run with the width dimension. If ordering RTF, please specify the laminate color for the back (white or almond). MDF and RTF options are not available in 1" thickness.

### RTF Moldings

See our Specification Catalog for full scale drawings of all moldings, including those available as RTF moldings. RTF moldings use the same foil colors that are used on the doors, so the color match is exact. RTF moldings have a solid wood core (Paint Grade Maple) and are priced by the 8' length. Only the face of the RTF molding is covered with foil, the back is unfinished wood.

### RTF Face Frame & Refacing Stock

RTF Face Frame and Refacing Stock, are made of a solid wood core (Paint Grade Maple), so they are not subject to the same thickness limitations as MDF. To calculate their cost, refer to the Paint Grade Maple square foot pricing in our Specification Catalog, and add the RTF square foot charge.



WalzCraft<sup>®</sup>.com



(Phone) 1-800-237-1326 7:00AM - 4:30PM CST (24 Hour Fax) 1-608-781-3667