

Molding Profiles

Discount available by using our
Molding "Shorts Program".

Refacing Moldings

1/8" Refacing Molding

Drawing not to Scale

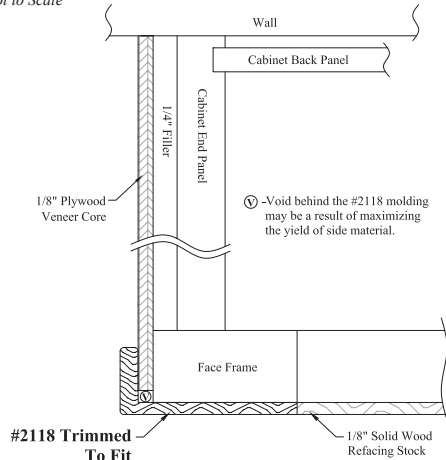

Molding #	Dimension "A"	Dimension "B"	Price Class	Square Foot
2115	1 ³ / ₁₆ " [30mm]	1" [25mm]	M101	.79
2331	1 ⁵ / ₁₆ " [33mm]	1 ¹ / ₈ " [29mm]	M101	.88
2116	1 ⁷ / ₁₆ " [37mm]	1 ¹ / ₄ " [32mm]	M101	.96
2332	1 ⁹ / ₁₆ " [40mm]	1 ³ / ₈ " [35mm]	M101	1.04
2117	1 ¹¹ / ₁₆ " [43mm]	1 ¹ / ₂ " [38mm]	M101	1.13
2333	1 ¹³ / ₁₆ " [46mm]	1 ⁵ / ₈ " [41mm]	M101	1.21
2118	1 ¹⁵ / ₁₆ " [49mm]	1 ³ / ₄ " [44mm]	M101	1.29
2334	2 ¹ / ₁₆ " [52mm]	1 ⁷ / ₈ " [48mm]	M101	1.38
2119	2 ³ / ₁₆ " [56mm]	2" [51mm]	M101	1.46
2335	2 ⁵ / ₁₆ " [59mm]	2 ¹ / ₈ " [54mm]	M101	1.54
2166	2 ⁷ / ₁₆ " [62mm]	2 ¹ / ₄ " [57mm]	M101	1.63
2336	2 ⁹ / ₁₆ " [65mm]	2 ³ / ₈ " [60mm]	M101	1.71
2120	2 ¹¹ / ₁₆ " [68mm]	2 ¹ / ₂ " [64mm]	M101	1.79
2337	2 ¹³ / ₁₆ " [71mm]	2 ⁵ / ₈ " [67mm]	M101	1.88
2167	2 ¹⁵ / ₁₆ " [75mm]	2 ³ / ₄ " [70mm]	M101	1.96
2338	3 ¹ / ₁₆ " [78mm]	2 ⁷ / ₈ " [73mm]	M101	2.04
2168	3 ³ / ₁₆ " [81mm]	3" [76mm]	M101	2.13
2339	3 ⁵ / ₁₆ " [84mm]	3 ¹ / ₈ " [79mm]	M101	2.21
2169	3 ⁷ / ₁₆ " [87mm]	3 ¹ / ₄ " [83mm]	M101	2.29
2340	3 ⁹ / ₁₆ " [90mm]	3 ³ / ₈ " [86mm]	M101	2.38
2341	3 ¹¹ / ₁₆ " [94mm]	3 ¹ / ₂ " [89mm]	M101	2.46

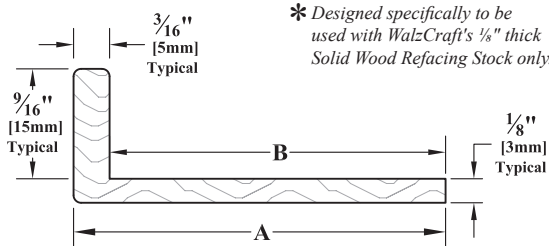

3/16" Refacing Molding

Drawing not to Scale

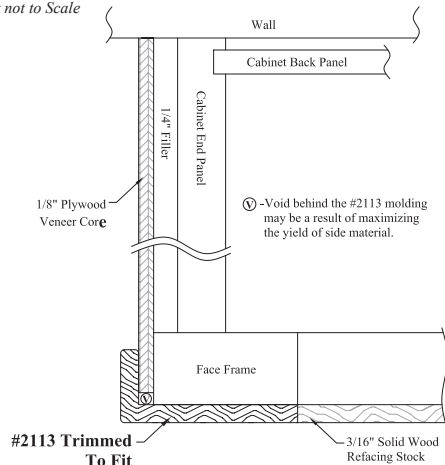

Molding #	Dimension "A"	Dimension "B"	Price Class	Square Foot
2145	1 ³ / ₁₆ " [30mm]	1" [25mm]	M101	.79
2342	1 ⁵ / ₁₆ " [33mm]	1 ¹ / ₈ " [29mm]	M101	.88
2111	1 ⁷ / ₁₆ " [37mm]	1 ¹ / ₄ " [32mm]	M101	.96
2343	1 ⁹ / ₁₆ " [40mm]	1 ³ / ₈ " [35mm]	M101	1.04
2142	1 ¹¹ / ₁₆ " [43mm]	1 ¹ / ₂ " [38mm]	M101	1.13
2344	1 ¹³ / ₁₆ " [46mm]	1 ⁵ / ₈ " [41mm]	M101	1.21
2113	1 ¹⁵ / ₁₆ " [49mm]	1 ³ / ₄ " [44mm]	M101	1.29
2345	2 ¹ / ₁₆ " [52mm]	1 ⁷ / ₈ " [48mm]	M101	1.38
2114	2 ³ / ₁₆ " [56mm]	2" [51mm]	M101	1.46
2346	2 ⁵ / ₁₆ " [59mm]	2 ¹ / ₈ " [54mm]	M101	1.54
2162	2 ⁷ / ₁₆ " [62mm]	2 ¹ / ₄ " [57mm]	M101	1.63
2347	2 ⁹ / ₁₆ " [65mm]	2 ³ / ₈ " [60mm]	M101	1.71
2143	2 ¹¹ / ₁₆ " [68mm]	2 ¹ / ₂ " [64mm]	M101	1.79
2348	2 ¹³ / ₁₆ " [71mm]	2 ⁵ / ₈ " [67mm]	M101	1.88
2163	2 ¹⁵ / ₁₆ " [75mm]	2 ³ / ₄ " [70mm]	M101	1.96
2349	3 ¹ / ₁₆ " [78mm]	2 ⁷ / ₈ " [73mm]	M101	2.04
2164	3 ³ / ₁₆ " [81mm]	3" [76mm]	M101	2.13
2350	3 ⁵ / ₁₆ " [84mm]	3 ¹ / ₈ " [79mm]	M101	2.21
2165	3 ⁷ / ₁₆ " [87mm]	3 ¹ / ₄ " [83mm]	M101	2.29
2351	3 ⁹ / ₁₆ " [90mm]	3 ³ / ₈ " [86mm]	M101	2.38
2352	3 ¹¹ / ₁₆ " [94mm]	3 ¹ / ₂ " [89mm]	M101	2.46

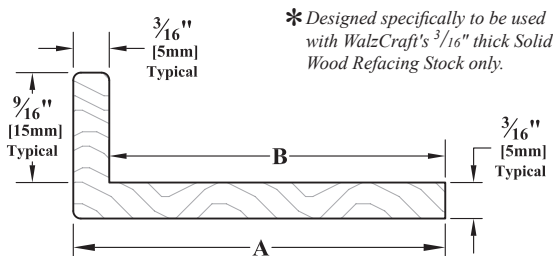

* We can control the finished thickness of the Refacing Moldings and Solid Wood Refacing Stock as they are produced in house. These moldings are not intended to be used with sheet stock, as plywood thicknesses are beyond our ability to control.



WalzCraft®



(Phone 7:00AM - 4:30PM CST) 1-800-237-1326

(24 Hour Fax) 1-608-781-3667

Molding Profiles

Molding Price Class codes are located near molding part number. Example...PC:M101

Molding Profiles

Miscellaneous Refacing Moldings

For 1/4" Plywood

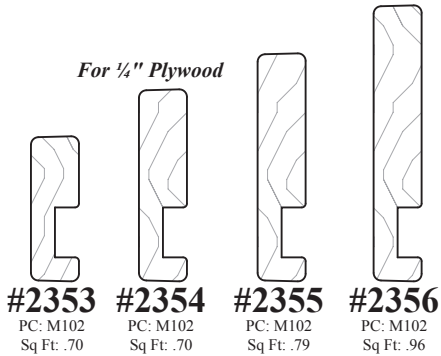

For 1/8" Plywood

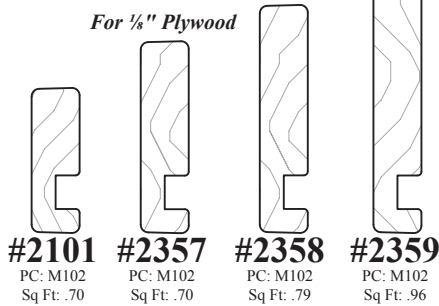

For Wood Back Veneer



For 1/4" Plywood

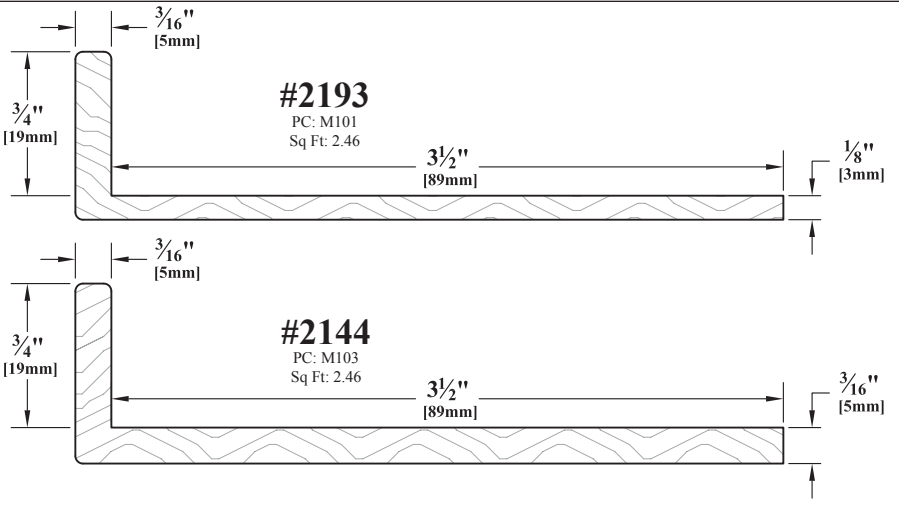
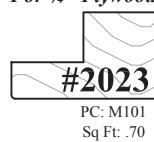
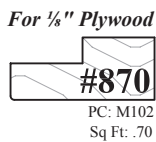

Straight Refacing Stock

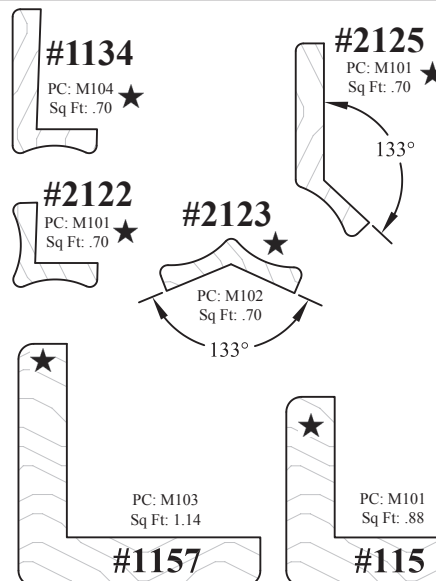
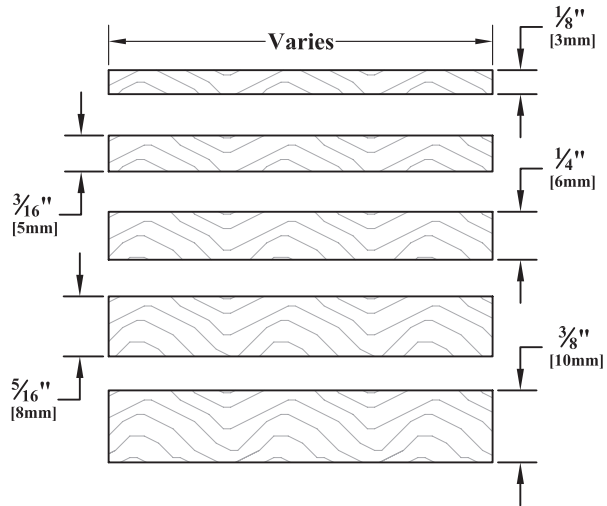

Outside Corner Moldings

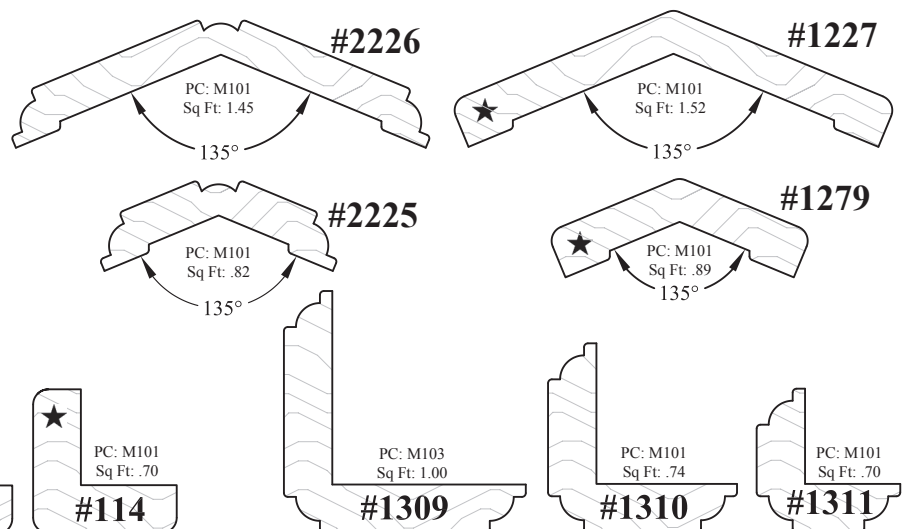

WalzCraft



(Phone 7:00AM - 4:30PM CST) 1-800-237-1326

(24 Hour Fax) 1-608-781-3667

Molding Profiles

Discount available by using our Molding "Shorts Program".

Molding Profiles

Baseshoe Molding



Quarter Round Moldings

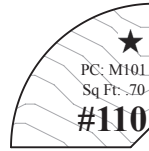

"Inside" Corner Molding



Scribe Moldings

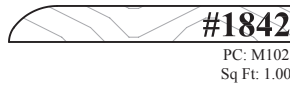
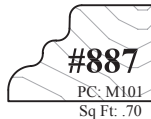

Panel Splice Molding

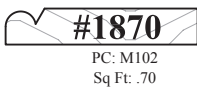
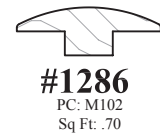

Cove Moldings

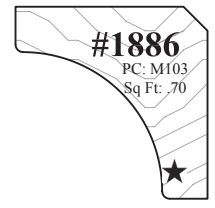
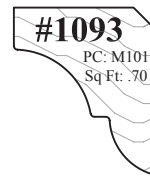

45 Degree Cabinet Filler

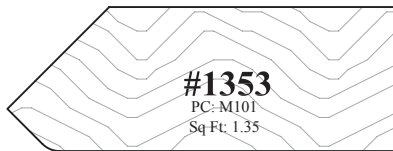

45 Degree Diagonal Filler

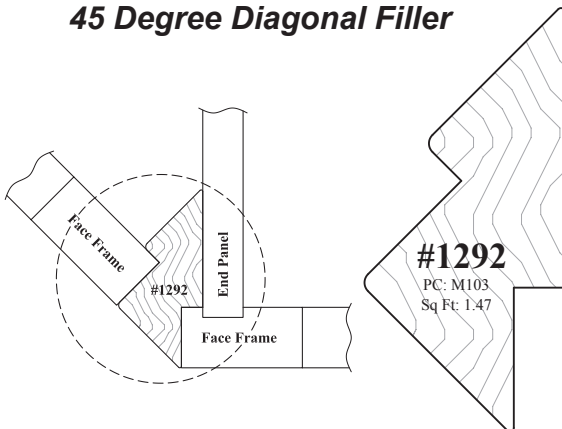

90 Degree Corner Moldings

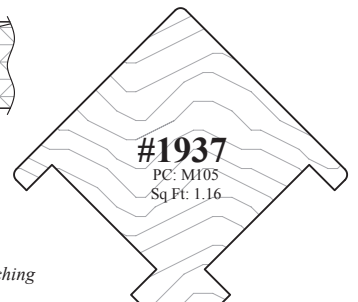
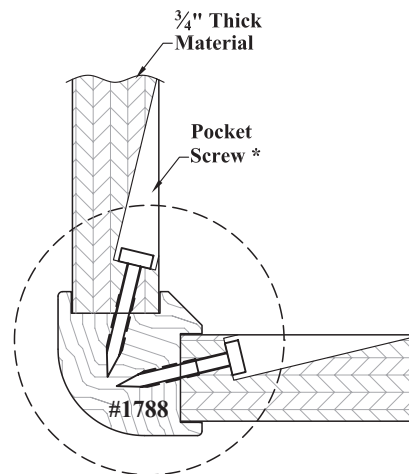

*Pocket screwing is just one possible method of attaching your 3/4" thick material to the corner molding.



WalzCraft®



(Phone 7:00AM - 4:30PM CST) 1-800-237-1326

(24 Hour Fax) 1-608-781-3667

