

Upper Cabinet Valances

Upper Cabinet Valances are drawn at 45" [1143.0mm] wide x 6" [152.4mm] high (#1789 shown at 6½" [165.1mm] high).



Style 157 Price Class:V200



Style 1712 Price Class:V200

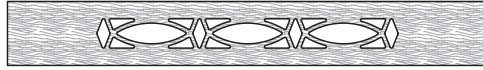

Style 158 Price Class:V300 (Shown with a D7 Outside Edge)



Style 1713 Price Class:V200

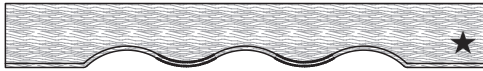

Style 169 Price Class:V200

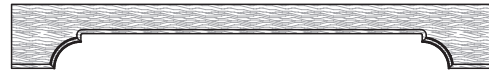

Style 1724 Price Class:V200

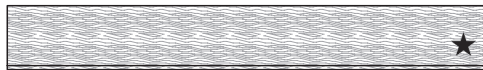

Style 170 Price Class:V100



Style 1726 Price Class:V200

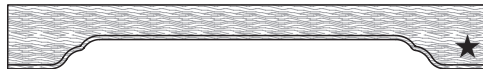

Style 175 Price Class:V200



Style 1789 Price Class:V200

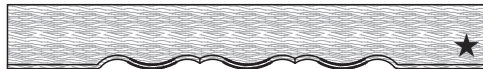

Style 197 Price Class:V200

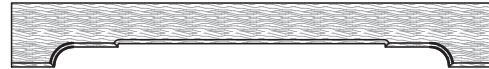

Style 1790 Price Class:V200

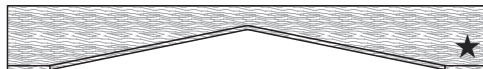

Style 199 Price Class:V200

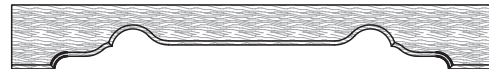

Style 2059 Price Class:V200

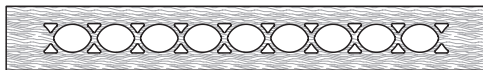

Style 211 Price Class:V300 (Shown with a D7 Outside Edge)

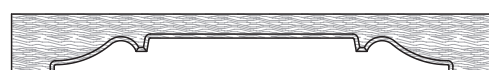

Style 2064 Price Class:V200

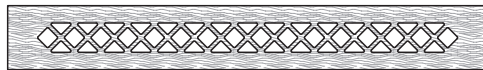

Style 212 Price Class:V300 (Shown with a D7 Outside Edge)

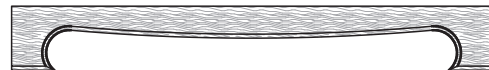

Style 2065 Price Class:V200

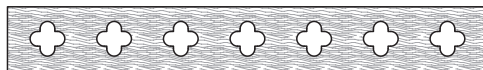

Style 213 Price Class:V300 (Shown with a D7 Outside Edge)

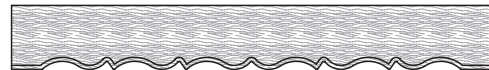

Style 2228 Price Class:V200

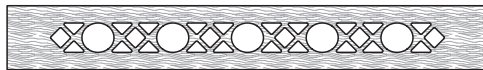

Style 917 Price Class:V300 (Shown with a D7 Outside Edge)

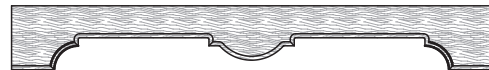

Style 2319 Price Class:V200

► **For PRICING** ► See Section *M.1* in our Wholesale Pricing Catalog.

M

Upper Cabinet Valances...continued

Upper Cabinet Valances are drawn at 45" [1143.0mm] wide x 6" [152.4mm] high (#1789 shown at 6½" [165.1mm] high).



Style 1387 Price Class: V300 (Shown with a D7 Outside Edge)



Style 2874 Price Class: V200

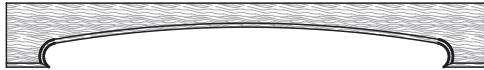

Style 2816 Price Class: V200

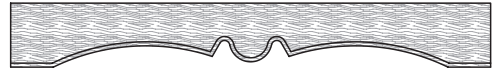

Style 2875 Price Class: V200

Upper Cabinet Valances are drawn at 45" [1143.0mm] wide x 10" [254.0mm] high.



Style 883 Price Class: V400

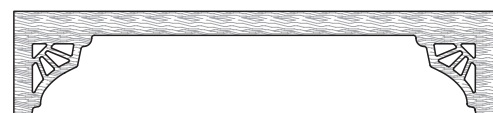

Style 1769 Price Class: V400



Style 984 Price Class: V200

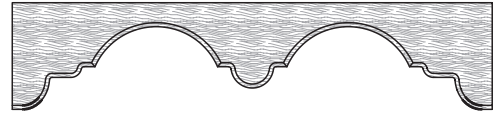

Style 2058 Price Class: V200

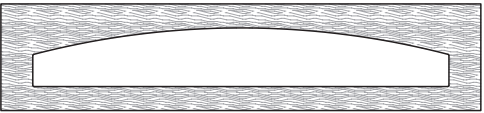

Style 1226 Price Class: V500

Upper Cabinet Valance Minimum Sizes

Style	Width	Height	Height at Narrowest	Flat at Left/Right	Style	Width	Height	Height at Narrowest	Flat at Left/Right	Style	Width	Height	Height at Narrowest	Flat at Left/Right
157	13" [330.2mm]	3¼" [82.6mm]	2¼" [57.2mm]	½" [12.7mm]	917	11⅞" [301.6mm]	5" [127.0mm]	NA	NA	2058	18½" [469.9mm]	10" [254.0mm]	2¼" [57.2mm]	NA
158	13¼" [336.6mm]	5" [127.0mm]	NA	NA	984	26⅞" [671.5mm]	10" [254.0mm]	2¼" [57.2mm]	NA	2059	23⅞" [595.3mm]	6" [152.4mm]	2¼" [57.2mm]	½" [12.7mm]
169	13" [330.2mm]	3⅞" [98.4mm]	2 ¼" [57.2mm]	2" [50.8mm]	1226	7" [177.8mm]	3½" [88.9mm]	2¼" [57.2mm]	NA	2064	21" [533.4mm]	6" [152.4mm]	2¼" [57.2mm]	½" [12.7mm]
170	3" [76.2mm]	2" [50.8mm]	NA	NA	1387	5¾" [146.1mm]	5" [127.0mm]	NA	NA	2065	13" [330.2mm]	6" [152.4mm]	2¼" [57.2mm]	1¼" [31.8mm]
175	13" [330.2mm]	5" [127.0mm]	2¼" [57.2mm]	½" [12.7mm]	1712	13" [330.2mm]	4 ²⁵ / ₃₂ " [121.4mm]	2¼" [57.2mm]	½" [12.7mm]	2228	13" [330.2mm]	3" [76.2mm]	2¼" [57.2mm]	2" [50.8mm]
197	13" [330.2mm]	3⅞" [98.4mm]	2¼" [57.2mm]	2" [50.8mm]	1713	13" [330.2mm]	4 ³ / ₃₂ " [104.0mm]	2¼" [57.2mm]	NA	2319	17½" [444.5mm]	5¼" [133.4mm]	2¼" [57.2mm]	½" [12.7mm]
199	13" [330.2mm]	3¼" [82.6mm]	2¼" [57.2mm]	½" [12.7mm]	1724	13" [330.2mm]	5½" [139.7mm]	2¼" [57.2mm]	½" [12.7mm]	2816	8" [203.2mm]	5" [127.0mm]	2¼" [57.2mm]	1½" [38.1mm]
211	8 ¹¹ / ₃₂ " [211.9mm]	5" [127.0mm]	NA	NA	1726	13" [330.2mm]	5½" [139.7mm]	2¼" [57.2mm]	½" [12.7mm]	2874	18" [457.2mm]	7¼" [184.2mm]	2¼" [57.2mm]	¾" [19.1mm]
212	7⅞" [187.3mm]	5" [127.0mm]	NA	NA	1769	17⅞" [435.0mm]	10" [254.0mm]	2¼" [57.2mm]	NA	2875	17½" [444.5mm]	4¾" [120.7mm]	2¼" [57.2mm]	½" [12.7mm]
213	6¼" [158.8mm]	5" [127.0mm]	NA	NA	1789	16" [406.4mm]	6½" [165.1mm]	2¼" [57.2mm]	½" [12.7mm]					
883	26⅞" [671.5mm]	10" [254.0mm]	2¼" [57.2mm]	NA	1790	15" [381.0mm]	4 ⁷ / ₁₆ " [112.7mm]	2¼" [57.2mm]	½" [12.7mm]					

► For PRICING ► See Section M.1 in our Wholesale Pricing Catalog.

Ordering & Pricing Notes: Upper Cabinet Valances

Ordering Guidelines

1	Order Forms	Please use <i>Valance and Knick Knack Order Form (E•Z Forms #6)</i> .
Pricing		
1	Pricing	Please see <i>Section M.1</i> of the Wholesale Pricing Catalog.

Technical Notes: Upper Cabinet Valances

Cabinet Accessories Options (Chapter M)

1	Style 157, 199 and 1712	Customer specifies the width, height, narrowest point of the valance (2¼" [57.2mm] minimum) and flat portion at the left and right sides. #1712 height must be greater than or equal to the narrowest plus 2½" [63.5mm] to maintain the "Look" of the valance design.	
2	Style 158, 211, 212, 213, 917, 883, 1226, 1387	Adding an outside edge profile other than D7 to these valance designs may require a change in the pattern placement. The same procedure applies to the Style #170 valance with a VR rout pattern.	
3	Style 169, 197, 2228	To order specify the overall width and height of the valance. These valances have set patterns that repeat as the width of the valance increases. One (1) set pattern width + (2" [50.8mm] minimum flat surface on end x 2) = Minimum Valance Width. The width of the flat surface on either end will vary, given valance width and requiring the use of full pattern sets to achieve that size.	
4	Style 1226	The minimum width at the "narrowest" point and for the bottom is 2¼" [57.2mm]. Please specify the dimension needed if you desire another size. A 1" [25.4mm] flat dimension must be maintained for the routed opening on each side.	
M	5	Style 175, 1724, 1726, 1789, 1790, 2059, 2064, 2319	Customer specifies the width, height and flat portion at the left and right sides.
6	Style 1713	Customer specifies the width, height and narrowest point of the valance. Height must be greater than or equal to the narrowest plus 3¾" [95.3mm], to maintain the "Look" of the valance design.	
7	Style 2065	Customer specifies the width, height and flat portion at the left and right sides. Radii at ends will not change in size. The narrowest at the top will get wider as the overall height is increased. The wider part in the middle will be ¾" [19.1mm] lower than the narrowest points at each end.	
8	Style 984, 1724, 1740, 1790, 2058, 2064, 2228, 2319	Only available with the following outside edge profiles: D7, D12, D15, D17, D18, D21, D24, D32, D41, D52, D67, D93, D101, D102, D115, D118 and D120 .	
9	Style 2816	Customer specifies the overall width, overall height, flat portion at the left and right sides and the height at the narrowest point. Radii at ends will not change in size.	
10	Style 2874	Customer specifies the overall width, overall height, flat portion at the left and right sides and the height at the narrowest point. Radii at ends will not change in size. Narrowest at top will get wider as height increases.	
11	Style 2875	Customer specifies the overall width, overall height, flat portion at the left and right sides and the height at the narrowest point. Radii at ends will change in size.	
12	Accent Profiles	Applied to one straight line edge only. Available on Solid Wood and MDF only. Available on materials of ¾" [19.1mm] or 1" [25.4mm] thicknesses.	

Notes Continued on Next Page...

► For PRICING ► See Section M.1 in our Wholesale Pricing Catalog.

Technical Notes: Upper Cabinet Valances...continued

Finish Options (Chapter R)

1	3D Laminate/RTF	The ★ indicates valance options that are available with 3D Laminate/RTF.
		When ordering valances with a wood grain 3D Laminate pattern, please specify grain direction.
		Back of valance must be specified as either white or almond melamine or matching 3D Laminate/RTF.
		D7 is not available on products using 3D Laminate (RTF). D33 will be used instead.

Material Options

1	Material	Available in solid wood and raw MDF.
---	----------	--------------------------------------

Profile Options (Chapter E)

1	Outside Edge Profiles	Outside Edge Profiles will be applied to shaped edge and straight bottom edge only and <i>will not</i> be applied to sides or top edge.
		D15 is considered the “Standard” Outside Edge for most Upper Cabinet Valances.
		D7 and D33 are also available on <i>all</i> valances.
		D7 is <i>not available</i> on products using 3D Laminate (RTF). <i>For additional Outside Edge options, please refer to Section E.15.</i>
2	Applied Molding Outside Edge Profiles	Applied molding outside edges are <i>only available</i> on the Style #170 valance.
		A 3/8" [15.9mm] thickness may be required for some of the applied edge options.
		<i>For Applied Molding Outside Edge options, please refer to Section E.16.</i>

Sizes / Dimensions

1	Thickness	Available in 3/4" [19.1mm] and 1" [25.4mm] thicknesses.
2	Width	Maximum width is 96" [2438.4mm].

M

► For PRICING ► See Section M.1 in our Wholesale Pricing Catalog.

Miscellaneous Joinery Options for Upper Cabinet and Toe Kick Valances

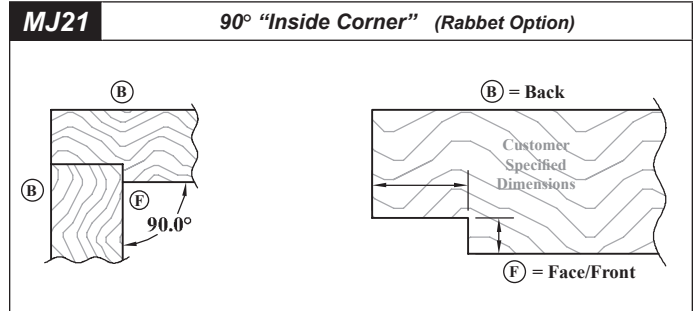
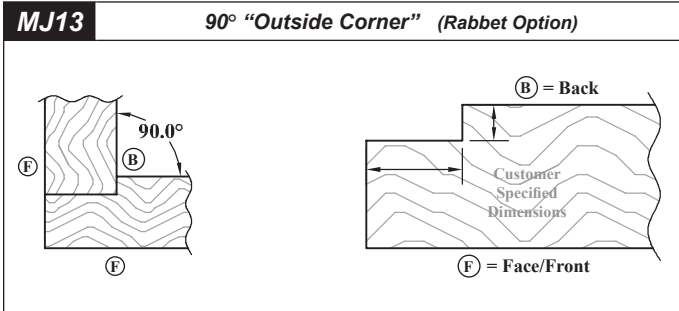
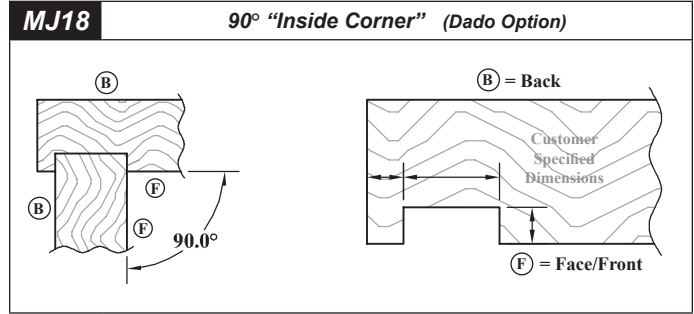
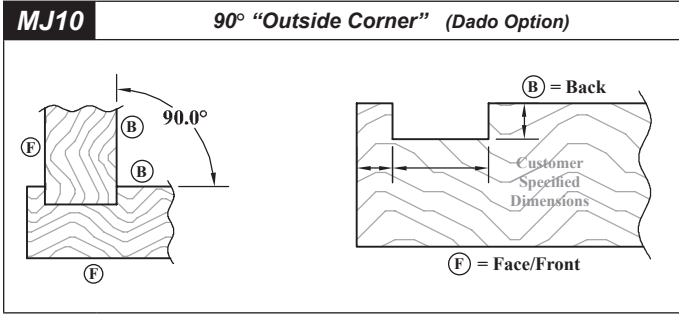

Dado Groove Example

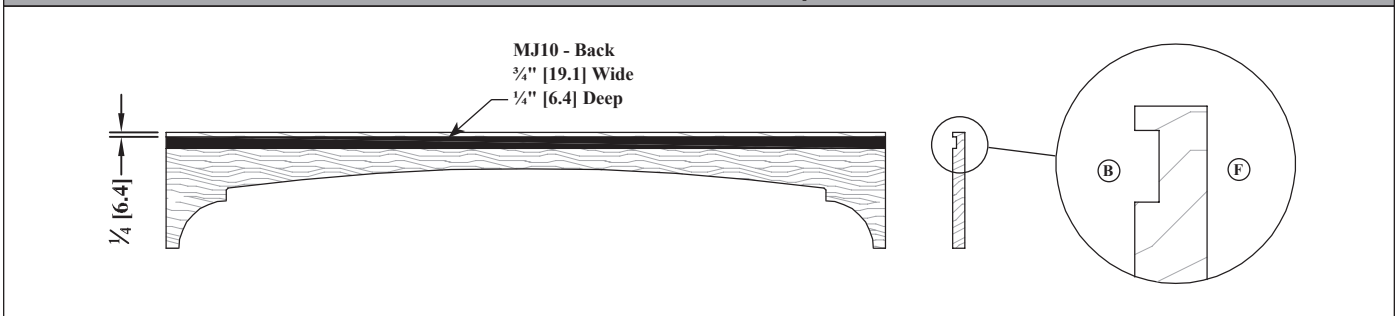

M

Ordering & Pricing Notes: Valance Options - Miscellaneous Joinery

Ordering Guidelines

1	Order Forms	Please use <i>Valance and Knick Knack Order Form (E•Z Forms #6)</i> .
		Fax your valance drawings along with your order forms to our Customer Support Team or e-mail drawings to: customersupport@WalzCraft.com .
2	Ordering Information	Specify the MJ option, along with the width, depth and placement from each outside edge of the valance. See <i>Miscellaneous Joinery Section F.2</i> for all joinery options.

Pricing

1	Pricing	Please see <i>Section M.1</i> of the Wholesale Pricing Catalog.
---	---------	---

► For PRICING ► See Section M.1 in our Wholesale Pricing Catalog.

Custom Valance Routing Options

You may customize a standard valance with any of these Routing Options.

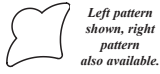

VR100L

Approx. 4½"W x 4½"H
[114.3mm x 114.3mm]
Min. Valance Ht.:
8" [203.2mm]

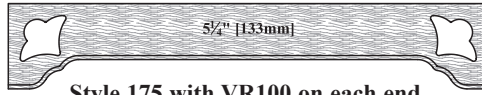

Style 175 with VR100 on each end.

(Drawing Represents a 45" [1143mm] W x 8" [203.2mm] H valance.)



VR500

Approx. 4½"w x 2¾"H
[114.3mm x 69.9mm]
Min. Valance Ht.:
5" [127.0mm]



VR200

Approx. 6"W x 2¾"H
[152.4mm x 69.9mm]
Min. Valance Ht.:
5" [127.0mm]



VR300

Approx. 10¼"W x 2¾"H
[260.4mm x 69.9mm]
Min. Valance Ht.:
5" [127.0mm]



VR400

Approx. 5⅝"W x 2¾"H
[134.9mm x 69.9mm]
Min. Valance Ht.:
5" [127.0mm]



VR600

Approx. 3¼"W x 3¼"H
[82.6mm x 82.6mm]
Min. Valance Ht.:
5½" [139.7mm]



VR700L

Approx. 7¾"W x 4½"H
[196.9mm x 114.3mm]
Min. Valance Ht.:
10¼" [260.4mm]



VR800

Approx. 8¾"W x 2¾"H
[225.4mm x 69.9mm]
Min. Valance Ht.:
5" [127.0mm]



VR900L

Approx. 3⅞"W x 4½"H
[98.4mm x 114.3mm]
Min. Valance Ht.:
10¼" [260.4mm]



VR1000

Approx. 2¾"W x 2¾"H
[69.9mm x 69.9mm]
Min. Valance Ht.:
5" [127.0mm]

Accent Profile Options

You may customize a standard valance with any of these Accent Profiles.

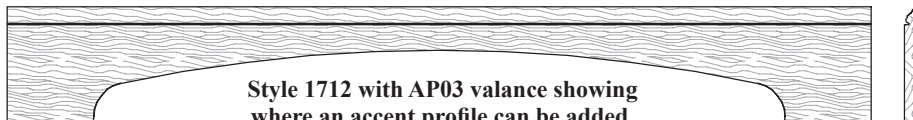

Style 1712 with AP03 valance showing where an accent profile can be added.

(Drawing Represents a 45" [1143.0mm] W x 6" [152.4mm] H valance.)

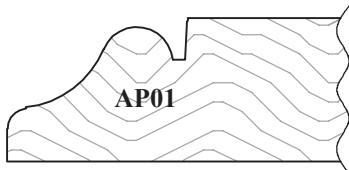

AP01

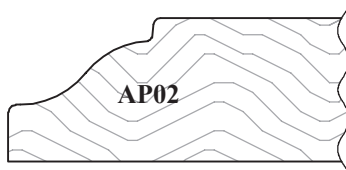

AP02

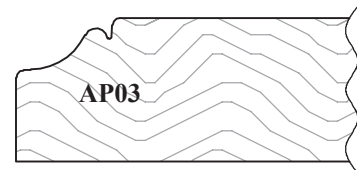

AP03

► **For PRICING** ► See Section *M.1* in our Wholesale Pricing Catalog.