

B

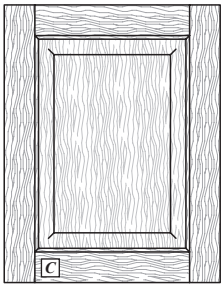

Style: 10

PC: 101
 Frame: PC101 x 0.6
 Min. Size: 8x8
 [203.2mm x 203.2mm]

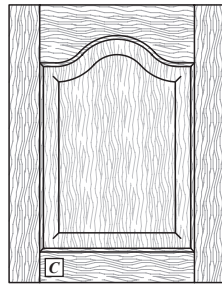

Style: 20

PC: 102
 Frame: PC102 x 0.6
 Min. Size: 8x9¼
 [203.2mm x 247.7mm]

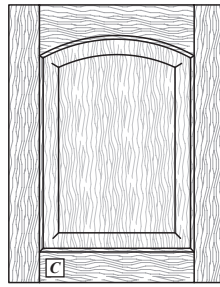

Style: 2000

PC: 102
 Frame: PC102 x 0.6
 Min. Size: 8x9¼
 [203.2mm x 247.7mm]

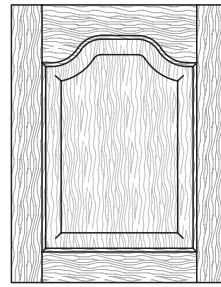

Style: 2200

PC: 102
 Frame: PC102 x 0.6
 Min. Size: 8x9¼
 [203.2mm x 247.7mm]

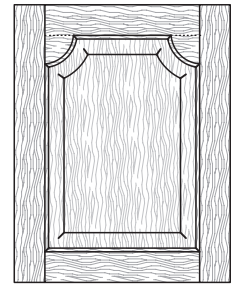

Style: 1090

PC: 107
 Frame: PC107 x 0.6
 Min. Size: 10⅞x9⅞
 [276.2mm x 239.7mm]



Style: 1010

PC: 103
 Frame: PC103 x 0.6
 Min. Size: 13⅞x8
 [349.3mm x 203.2mm]

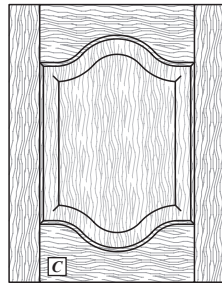

Style: 2020

PC: 106
 Frame: PC106 x 0.6
 Min. Size: 8x11½
 [203.2mm x 292.1mm]

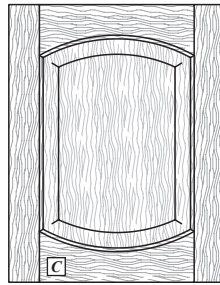

Style: 4000

PC: 106
 Frame: PC106 x 0.6
 Min. Size: 8x11½
 [203.2mm x 292.1mm]

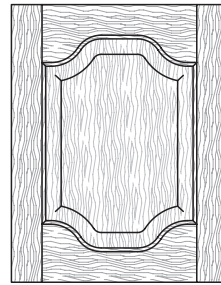

Style: 2222

PC: 106
 Frame: PC106 x 0.6
 Min. Size: 8x11½
 [203.2mm x 292.1mm]

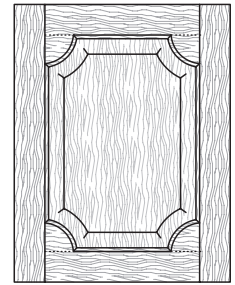

Style: 1080

PC: 111
 Frame: PC111 x 0.6
 Min. Size: 10⅞x10⅞
 [276.2mm x 276.2mm]

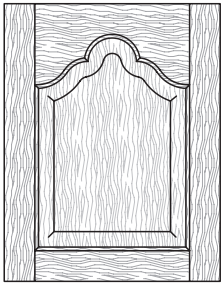

Style: 7000

PC: 104
 Frame: PC104 x 0.6
 Min. Size: 12x11¼
 [304.8mm x 285.8mm]

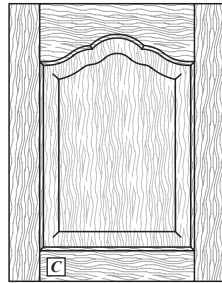

Style: 2500

PC: 102
 Frame: PC102 x 0.6
 Min. Size: 8x9¼
 [203.2mm x 247.7mm]

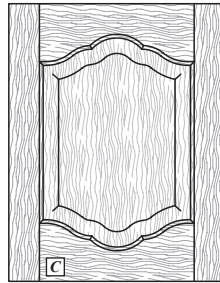

Style: 2525

PC: 106
 Frame: PC106 x 0.6
 Min. Size: 8x11½
 [203.2mm x 292.1mm]

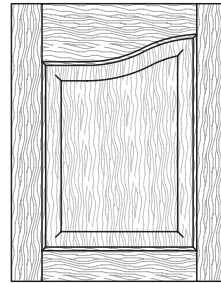

Style: 2070L

PC: 102
 Frame: PC102 x 0.6
 Min. Size: 8x9¼
 [203.2mm x 247.7mm]

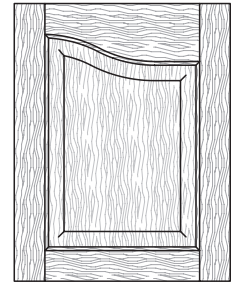

Style: 2070R

PC: 102
 Frame: PC102 x 0.6
 Min. Size: 8x9¼
 [203.2 mm x 247.7mm]

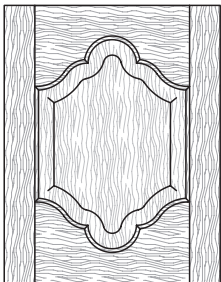

Style: 7070

PC: 109
 Frame: PC109 x 0.6
 Min. Size: 12x14½
 [304.8mm x 368.3mm]

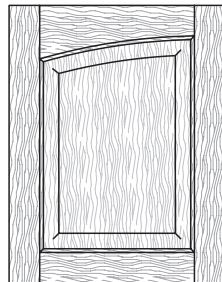

Style: 2001L

PC: 102
 Frame: PC102 x 0.6
 Min. Size: 8x9¼
 [203.2mm x 247.7mm]

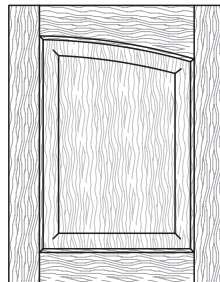

Style: 2001R

PC: 102
 Frame: PC102 x 0.6
 Min. Size: 8x9¼
 [203.2mm x 247.7mm]

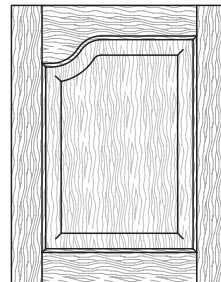

Style: 2201L

PC: 102
 Frame: PC102 x 0.6
 Min. Size: 8x9¼
 [203.2mm x 247.7mm]

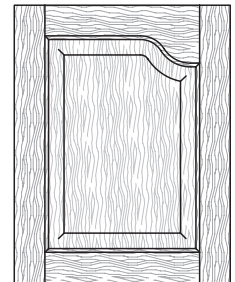

Style: 2201R

PC: 102
 Frame: PC102 x 0.6
 Min. Size: 8x9¼
 [203.2mm x 247.7mm]

► For PRICING ► See Section B.1 in our Wholesale Pricing Catalog.

“Traditional” Mortise & Tenon - Raised Panel

Cabinet Door & Drawer Front Options

B

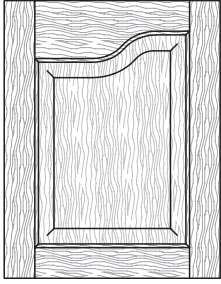

Style: 2800L

PC: 102
 Frame: PC102 x 0.6
 Min. Size: 12x9¼
 [304.8mm x 247.7mm]

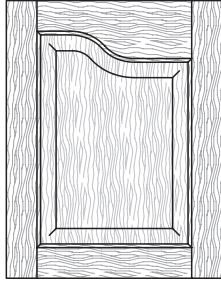

Style: 2800R

PC: 102
 Frame: PC102 x 0.6
 Min. Size: 12x9¼
 [304.8mm x 247.7mm]

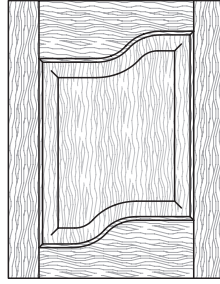

Style: 2828L

PC: 106
 Frame: PC106 x 0.6
 Min. Size: 12x11½
 [304.8mm x 292.1mm]

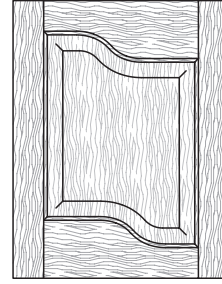

Style: 2828R

PC: 106
 Frame: PC106 x 0.6
 Min. Size: 12x11½
 [304.8mm x 292.1mm]

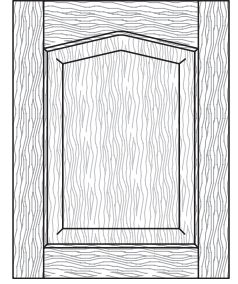

Style: 25

PC: 102
 Frame: PC102 x 0.6
 Min. Size: 8x9¼
 [203.2mm x 247.7mm]

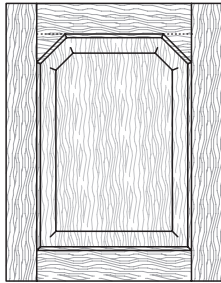

Style: 1060

PC: 107
 Frame: PC107 x 0.6
 Min. Size: 9x10¼
 [228.6mm x 273.1mm]

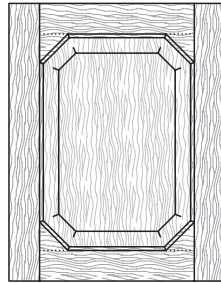

Style: 1070

PC: 111
 Frame: PC111 x 0.6
 Min. Size: 9x12½
 [228.6mm x 317.5mm]

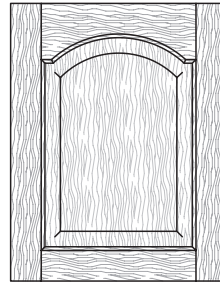

Style: 2005

PC: 102
 Frame: PC102 x 0.6
 Min. Size: 8x9¼
 [203.2mm x 247.7mm]

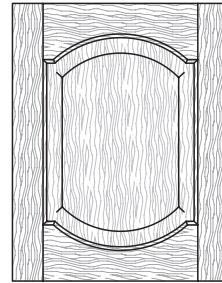

Style: 2055

PC: 106
 Frame: PC106 x 0.6
 Min. Size: 8x11½
 [203.2mm x 292.1mm]

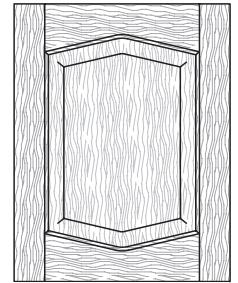

Style: 2727

PC: 106
 Frame: PC106 x 0.6
 Min. Size: 8x11½
 [203.2mm x 292.1mm]

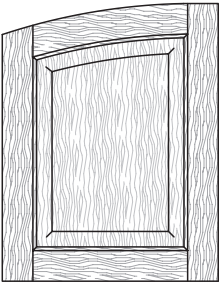

Style: 2011L

PC: 123
 Frame: PC123 x 0.6
 Min. Size: 8x9¼
 [203.2mm x 247.7mm]

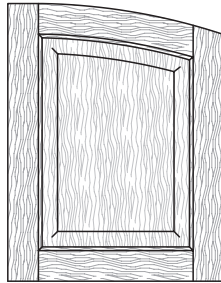

Style: 2011R

PC: 123
 Frame: PC123 x 0.6
 Min. Size: 8x9¼
 [203.2mm x 247.7mm]

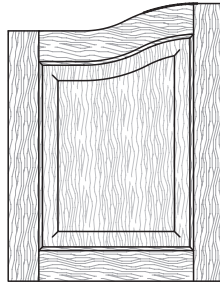

Style: 2077L

PC: 123
 Frame: PC123 x 0.6
 Min. Size: 8x9¼
 [203.2mm x 247.7mm]

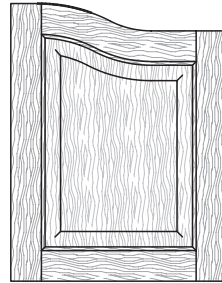

Style: 2077R

PC: 123
 Frame: PC123 x 0.6
 Min. Size: 8x9¼
 [203.2mm x 247.7mm]

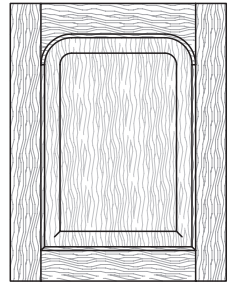

Style: 1055

PC: 119
 Frame: PC119 x 0.6
 Min. Size: 8x9¼
 [203.2mm x 247.7mm]

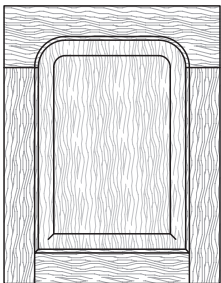

Style: 1065

PC: 130
 Frame: PC130 x 0.6
 Min. Size: 8x9¼
 [203.2mm x 247.7mm]

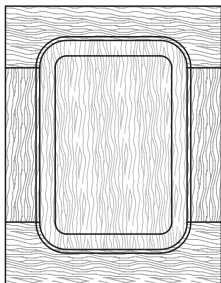

Style: 1075

PC: 120
 Frame: PC120 x 0.6
 Min. Size: 8x11½
 [203.2mm x 292.1mm]

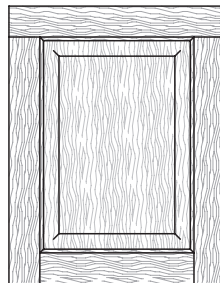

Style: 1800

PC: 118
 Frame: PC118 x 0.6
 Min. Size: 8x8
 [203.2mm x 203.2mm]

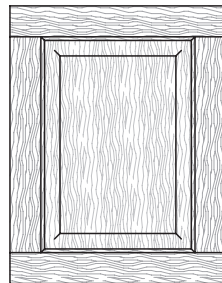

Style: 1801

PC: 101
 Frame: PC101 x 0.6
 Min. Size: 8x8
 [203.2mm x 203.2mm]

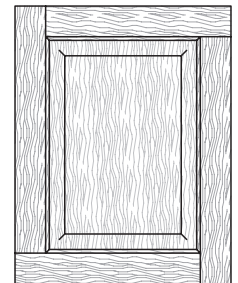

Style: 2433

PC: 118
 Frame: PC118 x 0.6
 Min. Size: 8x8
 [203.2mm x 203.2mm]

► **For PRICING** ► See Section B.1 in our Wholesale Pricing Catalog.

Cabinet Door & Drawer Front Options

“Traditional” Mortise & Tenon - Raised Panel

B

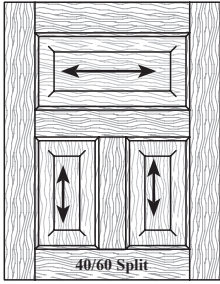

Style: 8010

PC: 131
 Frame: PC131 x 0.6
 Min. Size: 13³/₄x15¹/₂
 [349.3mm x 393.7mm]

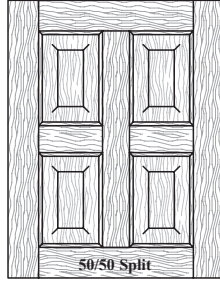

Style: 8160

PC: 115
 Frame: PC115 x 0.6
 Min. Size: 13³/₄x13³/₄
 [349.3mm x 349.3mm]

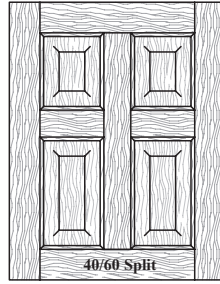

Style: 8170

PC: 115
 Frame: PC115 x 0.6
 Min. Size: 13³/₄x15¹/₂
 [349.3mm x 393.7mm]

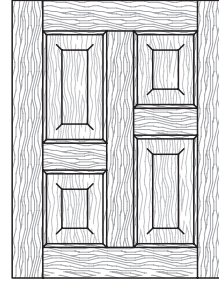

Style: 8060L

PC: 132
 Frame: PC132 x 0.6
 Min. Size: 13³/₄x15¹/₂
 [349.3mm x 393.7mm]

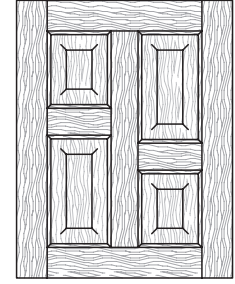

Style: 8060R

PC: 132
 Frame: PC132 x 0.6
 Min. Size: 13³/₄x15¹/₂
 [349.3mm x 393.7mm]

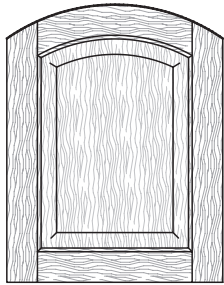

Style: 2187

PC: 123
 Frame: PC123 x 0.6
 Min. Size: 8x9³/₄
 [203.2mm x 247.7mm]

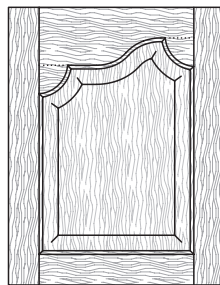

Style: 2100L

PC: 121
 Frame: PC121 x 0.6
 Fixed Min: 12x11³/₁₆
 [304.8mm x 284.2mm]

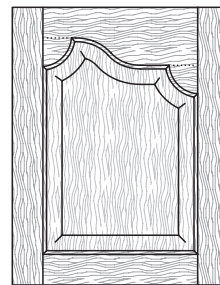

Style: 2100R

PC: 121
 Frame: PC121 x 0.6
 Fixed Min: 12x11³/₁₆
 [304.8mm x 284.2mm]

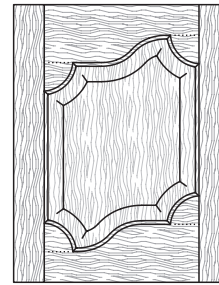

Style: 2121L

PC: 124
 Frame: PC124 x 0.6
 Fixed Min: 12x12⁵/₈
 [304.8mm x 320.7mm]

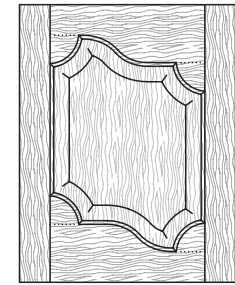

Style: 2121R

PC: 124
 Frame: PC124 x 0.6
 Fixed Min: 12x12⁵/₈
 [304.8mm x 320.7mm]

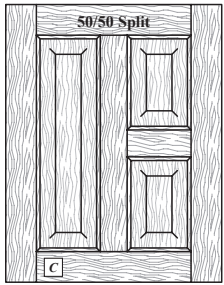

Style: 2291L

PC: 131
 Frame: PC131 x 0.6
 Min. Size: 13³/₄x13³/₄
 [349.3mm x 349.3mm]

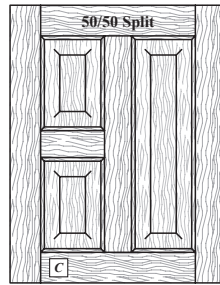

Style: 2291R

PC: 131
 Frame: PC131 x 0.6
 Min. Size: 13³/₄x13³/₄
 [349.3mm x 349.3mm]



Style: 2524

PC: 105
 Frame: PC105 x 0.6
 Min. Size: 8x15¹/₂
 [203.2mm x 393.7mm]



Style: 2755

PC: 112
 Frame: PC112 x 0.6
 Min. Size: 8x17¹/₈
 [203.2mm x 435mm]

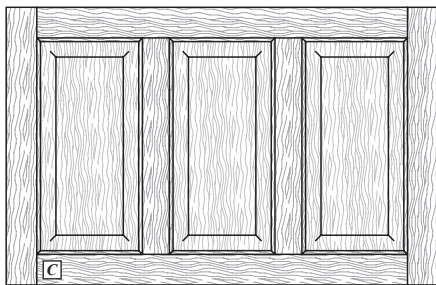

Style: 8020

PC: 108
 Frame: PC108 x 0.6
 Min. Size: 19¹/₂x8
 [495.3mm x 203.2mm]

► **For PRICING** ► See Section **B.1** in our Wholesale Pricing Catalog.



“Traditional” Mortise & Tenon - Raised Panel

Cabinet Door & Drawer Front Options

B

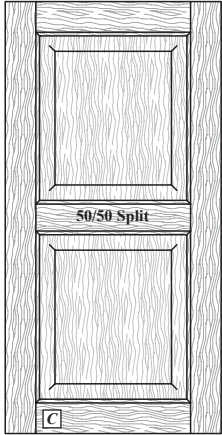

Style: 8000

PC: 103
 Frame: PC103 x 0.6
 Min. Size: 8x13¼
 [203.2mm x 349.3mm]



Style: 1000

PC: 103
 Frame: PC103 x 0.6
 Min. Size: 8x15½
 [203.2mm x 393.7mm]



Style: 1941

PC: 103
 Frame: PC103 x 0.6
 Min. Size: 8x16¾
 [203.2mm x 415.9mm]



Style: 8045

PC: 103
 Frame: PC103 x 0.6
 Min. Size: 8x16¾
 [203.2mm x 415.9mm]



Style: 2050

PC: 105
 Frame: PC105 x 0.6
 Min. Size: 8x15½
 [203.2mm x 393.7mm]

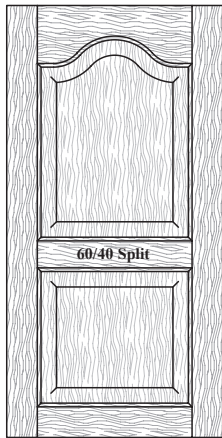

Style: 2010

PC: 105
 Frame: PC105 x 0.6
 Min. Size: 8x15½
 [203.2mm x 393.7mm]

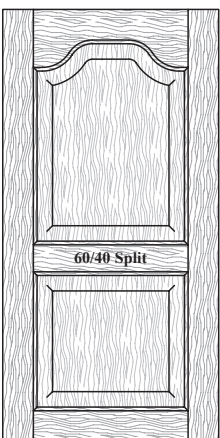

Style: 2210

PC: 105
 Frame: PC105 x 0.6
 Min. Size: 8x15½
 [203.2mm x 393.7mm]



Style: 2105

PC: 105
 Frame: PC105 x 0.6
 Min. Size: 8x15½
 [203.2mm x 393.7mm]



Style: 2505

PC: 105
 Frame: PC105 x 0.6
 Min. Size: 8x15½
 [203.2mm x 393.7mm]

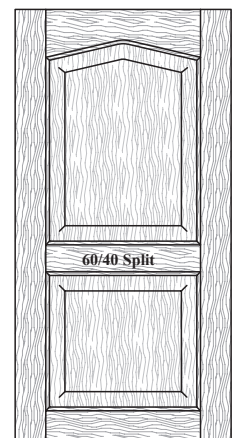

Style: 2550

PC: 105
 Frame: PC105 x 0.6
 Min. Size: 8x15½
 [203.2mm x 393.7mm]

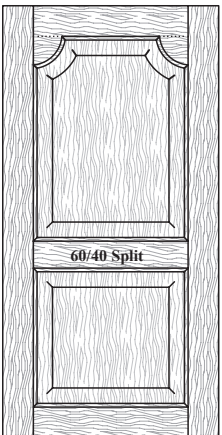

Style: 1020

PC: 114
 Frame: PC114 x 0.6
 Min. Size: 9x16½
 [228.6mm x 419.1mm]



Style: 7010

PC: 113
 Frame: PC113 x 0.6
 Min. Size: 12x17
 [304.8mm x 431.8mm]



Style: 2323

PC: 112
 Frame: PC112 x 0.6
 Min. Size: 8x17½
 [203.2mm x 444.5mm]

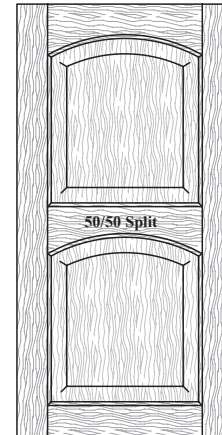

Style: 2025

PC: 112
 Frame: PC112 x 0.62
 Min. Size: 8x17¼
 [203.2mm x 438.2mm]

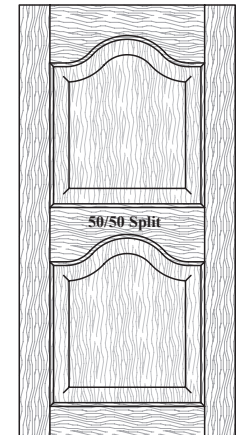

Style: 2035

PC: 112
 Frame: PC112 x 0.6
 Min. Size: 8x17¼
 [203.2mm x 438.2mm]

► **For PRICING** ► See Section **B.1** in our Wholesale Pricing Catalog.

B



Style: 8050

PC: 132
Frame: PC132 x 0.6
Min. Size: 13³/₄x23
[349.3mm x 584.2mm]

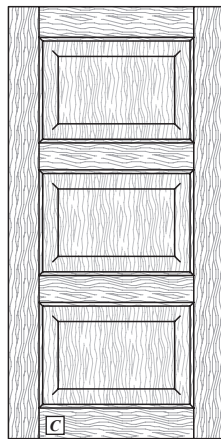

Style: 8030

PC: 108
Frame: PC108 x 0.6
Min. Size: 8x19¹/₂
[203.2mm x 495.3mm]

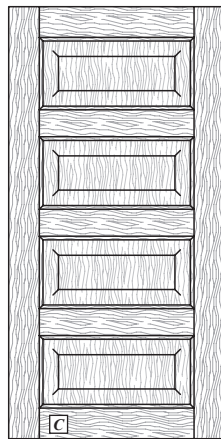

Style: 2271

PC: 115
Frame: PC115 x 0.6
Min. Size: 8x25¹/₄
[203.2mm x 641.4mm]

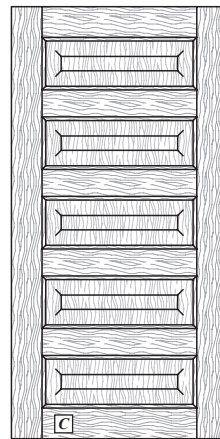

Style: 2272

PC: 117
Frame: PC117 x 0.6
Min. Size: 8x31
[203.2mm x 787.4mm]



Style: 2427

PC: 131
Frame: PC131 x 0.6
Min. Size: 13³/₄x16³/₈
[349.3mm x 415.9mm]

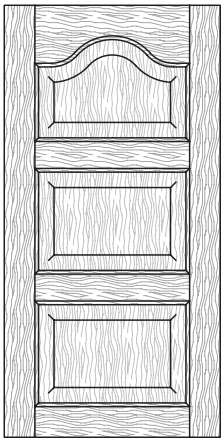

Style: 2185

PC: 110
Frame: PC110 x 0.6
Min. Size: 8x21¹/₄
[203.2mm x 539.8mm]

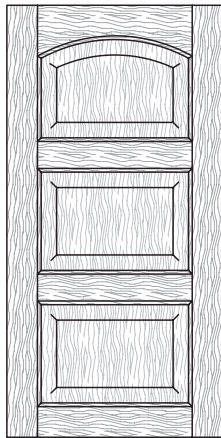

Style: 2186

PC: 110
Frame: PC110 x 0.6
Min. Size: 8x21¹/₄
[203.2mm x 539.8mm]

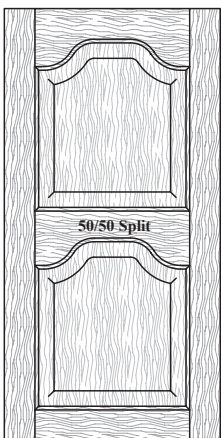

Style: 2036

PC: 112
Frame: PC112 x 0.6
Min. Size: 8x17¹/₄
[203.2mm x 438.2mm]



Style: 2422L

PC: 105
Frame: PC105 x 0.6
Min. Size: 8x15¹/₂
[203.2mm x 393.7mm]



Style: 2422R

PC: 105
Frame: PC105 x 0.6
Min. Size: 8x15¹/₂
[203.2mm x 393.7mm]

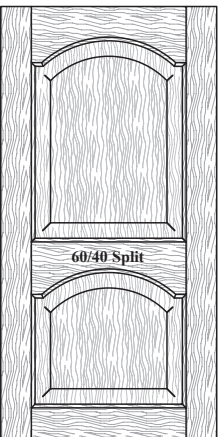

Style: 2288

PC: 112
Frame: PC112 x 0.6
Min. Size: 8x16³/₈
[203.2mm x 422.3mm]



Style: 2418

PC: 128
Frame: PC128 x 0.6
Min. Size: 10¹/₈x16³/₈
[203.2mm x 422.3mm]



Style: 2420L

PC: 105
Frame: PC105 x 0.6
Min. Size: 8x15¹/₂
[203.2mm x 393.7mm]



Style: 2420R

PC: 105
Frame: PC105 x 0.6
Min. Size: 8x15¹/₂
[203.2mm x 393.7mm]

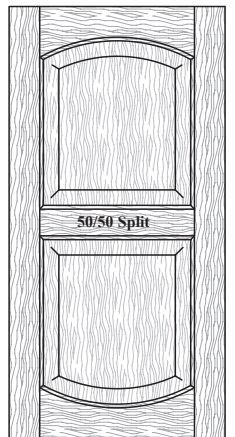

Style: 2425

PC: 112
Frame: PC112 x 0.6
Min. Size: 8x17¹/₄
[203.2mm x 438.2mm]

► For PRICING ► See Section B.1 in our Wholesale Pricing Catalog.

“Traditional” Mortise & Tenon - Raised Panel

Cabinet Door & Drawer Front Options

B

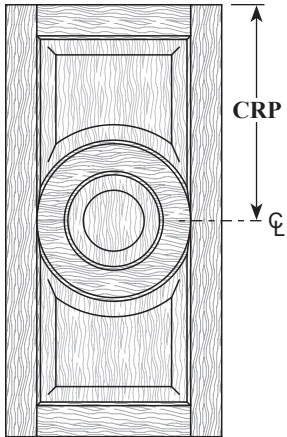

Style: 2156

PC: 127
 Frame: PC127 x 0.6
 Min. Size: 11x22
 [279.4mm x 558.8mm]

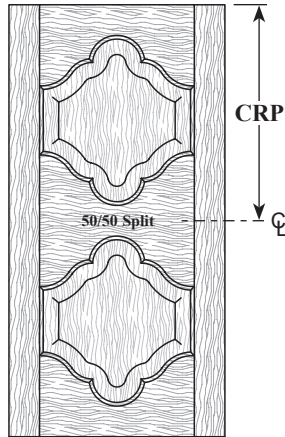

Style: 2456

PC: 135
 Frame: PC135 x 0.6
 Min. Size: 12x26¾
 [304.8mm x 679.5mm]

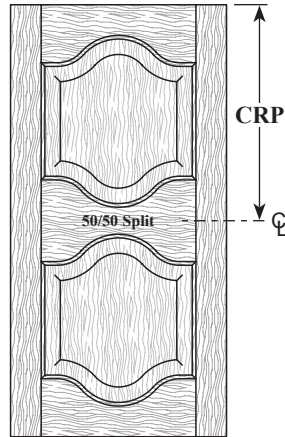

Style: 2424

PC: 116
 Frame: PC116 x 0.6
 Min. Size: 8x20¼
 [203.2mm x 527.1mm]

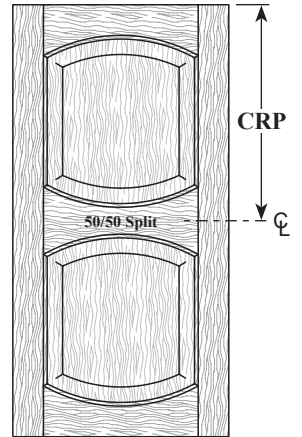

Style: 2171

PC: 116
 Frame: PC116 x 0.6
 Min. Size: 8x20¼
 [203.2mm x 527.1mm]

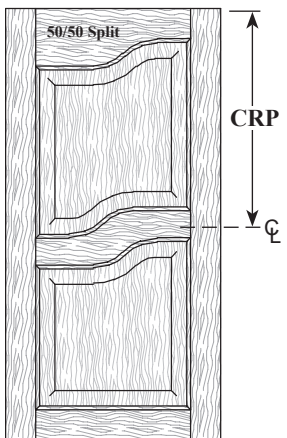

Style: 2563L

PC: 138
 Frame: PC138 x 0.6
 Min. Size: 12x17
 [304.8mm x 431.8mm]

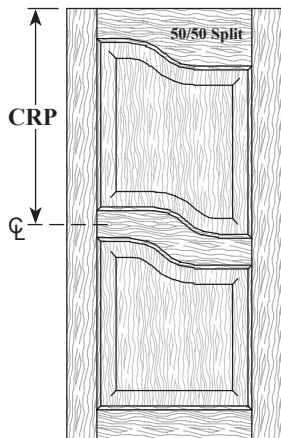

Style: 2563R

PC: 138
 Frame: PC138 x 0.6
 Min. Size: 12x17
 [203.2mm x 431.8mm]

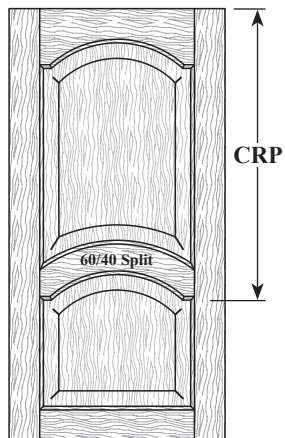

Style: 2287

PC: 138
 Frame: PC138 x 0.6
 Min. Size: 8x15½
 [203.2mm x 403.2mm]

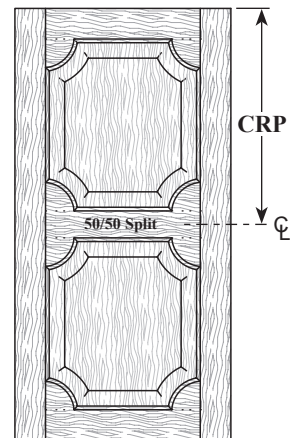

Style: 2416

PC: 129
 Frame: PC129 x 0.6
 Min. Size: 10¾x19½
 [276.2mm x 495.3mm]

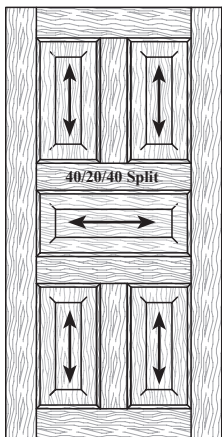

Style: 2465

PC: 136
 Frame: PC136 x 0.6
 Min. Size: 13¾x25
 [349.3mm x 635mm]



Style: 2498L

PC: 137
 Frame: PC137 x 0.6
 Min. Size: 8x15½
 [203.2mm x 393.7mm]

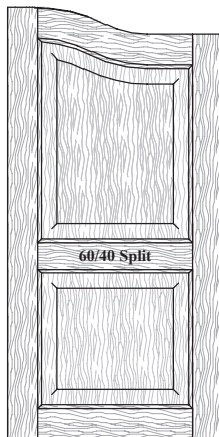

Style: 2498R

PC: 137
 Frame: PC137 x 0.6
 Min. Size: 8x15½
 [203.2mm x 393.7mm]

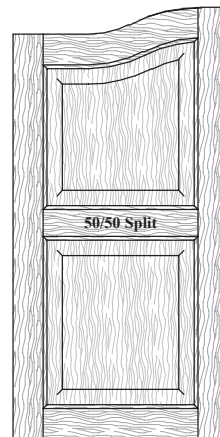

Style: 2501L

PC: 137
 Frame: PC137 x 0.6
 Min. Size: 8x17¼
 [203.2mm x 438.2mm]



Style: 2501R

PC: 137
 Frame: PC137 x 0.6
 Min. Size: 8x17¼
 [203.2mm x 438.2mm]

☒ = Center Line of Center Rail

CRP = Center Rail Placement.



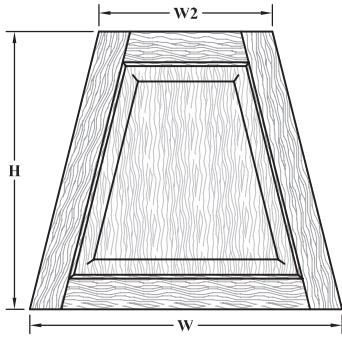

Style: 2234

PC: 122
 Frame: PC122 x 0.6
 Min. Size: 8x8
 [203.2mm x 203.2mm]
 See Notes for Ordering Information

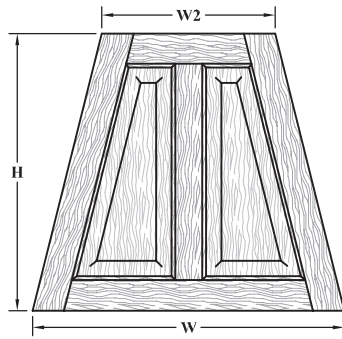

Style: 2235

PC: 126
 Frame: PC126 x 0.6
 Min. Size: 13³/₄x8
 [349.3mm x 203.2mm]
 See Notes for Ordering Information

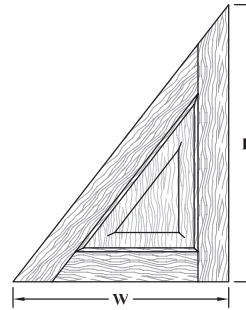

Style: 2231L

PC: 122
 Frame: PC122 x 0.6
 Min. Size: 8x8
 [203.2mm x 203.2mm]
 See Notes for Ordering Information

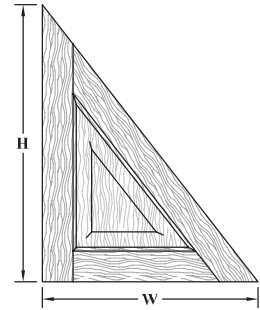

Style: 2231R

PC: 122
 Frame: PC122 x 0.6
 Min. Size: 8x8
 [203.2mm x 203.2mm]
 See Notes for Ordering Information

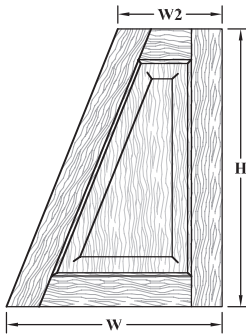

Style: 2232L

PC: 122
 Frame: PC122 x 0.6
 Min. Size: 8x8
 [203.2mm x 203.2mm]
 See Notes for Ordering Information

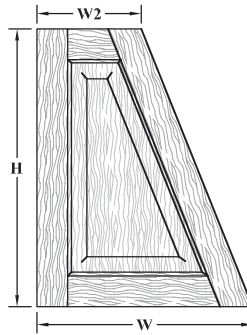

Style: 2232R

PC: 122
 Frame: PC122 x 0.6
 Min. Size: 8x8
 [203.2mm x 203.2mm]
 See Notes for Ordering Information

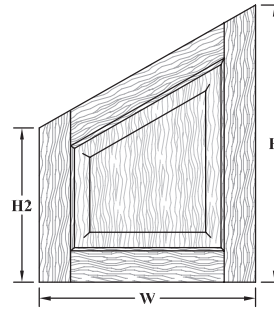

Style: 2284L

PC: 122
 Frame: PC122 x 0.6
 Min. Size: 8x8
 [203.2mm x 203.2mm]
 See Notes for Ordering Information

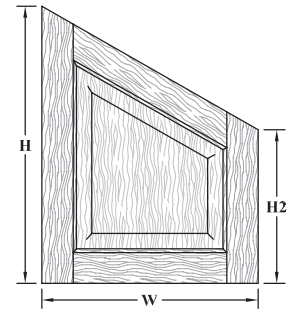

Style: 2284R

PC: 122
 Frame: PC122 x 0.6
 Min. Size: 8x8
 [203.2mm x 203.2mm]
 See Notes for Ordering Information

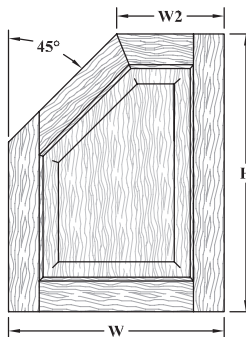

Style: 2631L

PC: 139
 Frame: PC139 x 0.6
 Min. Size: 9³/₄x9³/₄
 [247.7mm x 247.7mm]
 See Notes for Ordering Information

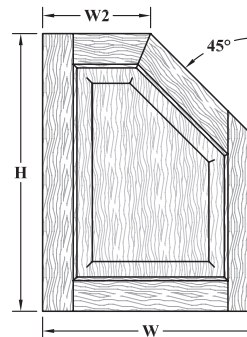

Style: 2631R

PC: 139
 Frame: PC139 x 0.6
 Min. Size: 9³/₄x9³/₄
 [247.7mm x 247.7mm]
 See Notes for Ordering Information

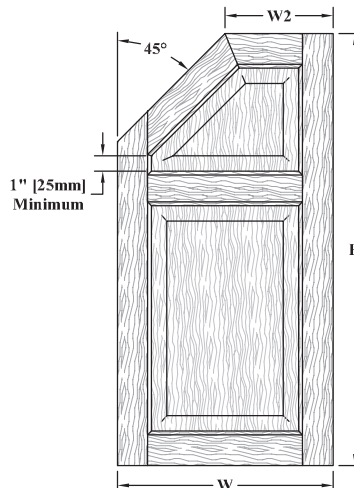

Style: 2289L

PC: 140
 Frame: PC140 x 0.6
 Min. Size: 9³/₄x13³/₄
 [247.7mm x 349.3mm]
 See Notes for Ordering Information

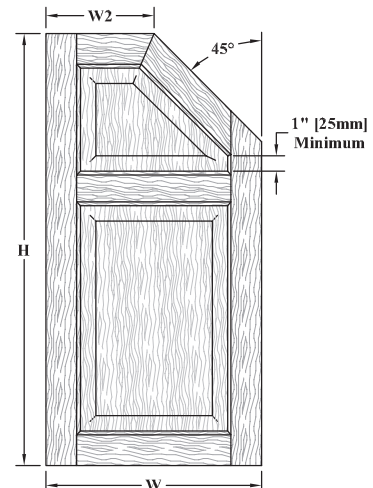

Style: 2289R

PC: 140
 Frame: PC140 x 0.6
 Min. Size: 9³/₄x13³/₄
 [247.7mm x 349.3mm]
 See Notes for Ordering Information

► For PRICING ► See Section B.1 in our Wholesale Pricing Catalog.

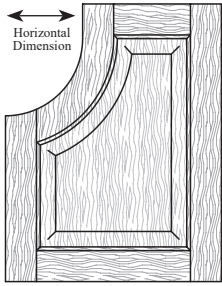

Style: 2021L

PC: 125
 Frame: PC125 x 0.6
 Min. Size: 10x12¼
 [254mm x 311.2mm]
 See Notes for Ordering Information

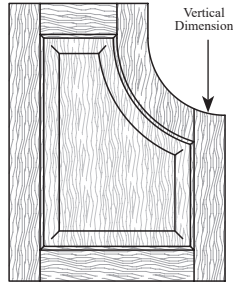

Style: 2021R

PC: 125
 Frame: PC125 x 0.6
 Min. Size: 10x12¼
 [254mm x 311.2mm]
 See Notes for Ordering Information

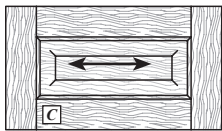

Style: 10*
 Drawer Front

PC: 101
 Frame: PC101 x 0.6
 Min. Size: 8x8
 [203.2mm x 203.2mm]

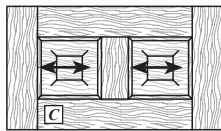

Style: 1010*
 Drawer Front

PC: 103
 Frame: PC103 x 0.6
 Min. Size: 13¼x8
 [349.3mm x 203.2mm]

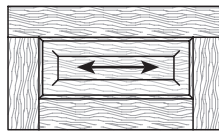

Style: 1800*
 Drawer Front

PC: 118
 Frame: PC118 x 0.6
 Min. Size: 8x8
 [203.2mm x 203.2mm]

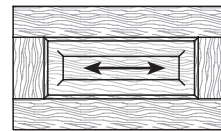

Style: 1801*
 Drawer Front

PC: 101
 Frame: PC101 x 0.6
 Min. Size: 8x8
 [203.2mm x 203.2mm]

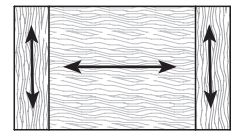

Style: 1026*
 Drawer Front

PC: 118
 Frame: NA
 Min. Size: 6¾x3
 [168.3mm x 76.2mm]

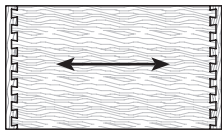

Style: 34DT*
 Drawer Front
 (Dovetail Look)

PC: 120
 Frame: NA
 Min. Size: 6¾x1¼
 [171.5mm x 44.5mm]
 Max Height: 30"

► For PRICING ► See Section **B.1** in our Wholesale Pricing Catalog.

Ordering & Pricing Notes: "Traditional" Mortise & Tenon Raised Panel Door and Drawer Fronts

Ordering Guidelines

1 Order Forms Please use *Door and/or Drawer Front Order Forms (E•Z Forms #2 and #3)*.

Pricing

1 Pricing Please see *Section B.1* of the Wholesale Pricing Catalog.

Technical Notes: "Traditional" Mortise & Tenon Raised Panel Door and Drawer Fronts

Cabinet Door & Drawer Front Options (Chapter B)

1 Frame & Mullion Doors Glass openings are routed to follow the contour of the shape for Styles **1060, 1070, 2011L, 2011R, 2077L, 2077R, 1055, 1065, 1075, 2100L, 2100R, 2121L, 2121R, 2021L, 2021R, 2187, 1020, 2156, 2498L, 2498R, 2501L, 2501R, 2563L, 2563R, 2631L, 2631R, 2289L, 2289R, 2234, 2235, 2231L, 2231R, 2232L, 2232R, 2284L, 2284R**. For pricing, please see *Section B.12* of the Wholesale Pricing Catalog.

2 Style 1026* Only available as a drawer front.
Maximum height is 12" [304.8mm]. Heights up to 6" [152.4mm] will be constructed without glue-ups whenever possible.

Only available with the **SR100** stile & rail profile. See *Section E.1*. When paired with any stile & rail door (ex: Style 10, Style 40, etc.), the door must also utilize the **SR100** and have the same width stiles as the **1026*** drawer front.

3 Style 2021L, 2021R Minimum radius = 2" [50.8mm]. The radius will equal 90 degrees of an arc on the outside edge.

The horizontal dimension of the curved stile equals the radius. *These door style illustrations depict a 14" x 18" [355.6mm x 457.2mm] door, given this dimension the curved stile radius is 5" [127mm].*

The vertical dimension of the curved stile equals the radius plus the width of the top rail. *Based on the 14" x 18" [355.6mm x 457.2mm] door size illustrated, this dimension would be 7¼" [184.2mm].*

When ordering, please provide the overall width and height of the door and note the horizontal dimension (radius) in the **Special Instructions** column on the order form.

4 Style 2156 Width cannot be greater than the height.

Minimum height must be 2 times the width minus 4" [101.6mm].

Available with all "Traditional" and Old World "Traditional" stile and rail profiles.

The center panel is ⅝" [15.9mm] thick and is flush to the stiles & rails on the face and recessed ⅜" [9.5mm] from the back.

A CAD drawing must be approved prior to manufacturing the product.

5 Style 2231L, 2231R Please provide overall width (W) and height (H).

Angles will vary as dimensions vary.

A CAD drawing must be approved prior to manufacturing the product.

6 Style 2232L, 2232R, 2234 Please provide overall width (W) and height (H), as well as the secondary width (W2) at the top of door.

Angles will vary as dimensions vary.

A CAD drawing must be approved prior to manufacturing the product.

7 Style 2235 Please provide overall width (W) and height (H), as well as the secondary width (W2) at the top of door.

Angles will vary as dimensions vary.

Center stile will be centered on width (50/50 split), unless otherwise noted.

A CAD drawing must be approved prior to manufacturing the product.

8 Style 2284L, 2284R Please provide overall width (W) and height (H), as well as the secondary height (H2) along the side of door.

Angles will vary as dimensions vary.

A CAD drawing must be approved prior to manufacturing the product.

9 Style 2289L, 2289R Please provide overall width (W) and height (H), as well as the secondary width (W2) at the top of door.

Angle is fixed at 45°.

Center rail is shown at its highest point, which is also its standard placement, unless otherwise noted.

A CAD drawing must be approved prior to manufacturing the product.

10 Style 2631L, 2631R Please provide overall width (W) and height (H), as well as the secondary width (W2) at the top of door.

Angle is fixed at 45°.

A CAD drawing must be approved prior to manufacturing the product.

11 Style 34DT* Only available as a drawer front.

Simulates the look of a dovetail drawer box. Dovetail size may vary as the height changes.

Heights up to 6" [152.4mm] will be constructed without glue-ups whenever possible.

Only available with a **D7** outside edge profile.

For 1" [25.4mm] thickness, order as a **Style 100DT***.

12 Style 8010, 8060 **Style 8010** and **Style 8060** are constructed with a 40/60 split.

13 Style 8160 **Style 8160** is constructed with a 50/50 split in both the width and height.

Notes Continued on Next Page...

Technical Notes: “Traditional” Mortise & Tenon Raised Panel Door and Drawer Fronts...continued

Convex / Concave Options (Chapter D)

1	Available Products	The ☐ indicates door styles that are available convex/concave (curved). See <i>Chapter D</i> for more information.
2	Hybrid Doors	Only available with MDF raised or MDF reversed center panels. Not available with ¼" [6.4mm] MDF center panels.
3	5-Piece MDF	Not available convex/concave.

Design Options (Chapter G)

1	5-Piece MDF	Not available with Simulated or Renaissance Distressing .
---	-------------	---

Finish Options (Chapter R)

1	5-Piece MDF	See “Finishing Methods” for information on MDF with “Primed Only for Paint” or “SolidTone® Colors”. Not available with 3D Laminate (RTF). Rub Through Options RBT100 and RBT200 are not available.
---	-------------	--

General Information (Chapter A)

1	Grain Direction	Arrows (↔) shown throughout the catalog indicate standard grain direction. Grain direction may be specified at NO additional cost.
2	Center Rail Placement	Custom center rail placements may be specified; <i>see Center Rail Placement in Section A.4.</i>
3	Stile & Rail Dimensions	Standard stile and rail dimensions are 2¼" [57.2mm] wide. Non-standard part sizes may be ordered, however, additional up-charges may apply. See <i>Section A.5</i> for more information.

Profile Options (Chapter E)

1	5-Piece MDF	Stile & Rail Profiles: All “Traditional” Stile & Rail Profile options shown in <i>Section E.1</i> are available. (MDF stile and rail profiles are engineered without the stain relief cuts.). Center Panel Profiles = All Center Panel Profile options shown in <i>Section E.12</i> are available. Outside Edge Profiles = All Outside Edge Profile options shown in <i>Section E.15 & E.16</i> are available.
---	-------------	--

Material Options

1	Materials Available	Available in all of the species/grades noted in <i>Section B.1</i> of the Wholesale Pricing Catalog .
2	5-Piece MDF	The following “Traditional” mortise & tenon raised panel door styles are available in MDF: 10, 1010, 1800, 1801, 8010, 8160, 8170, 8060L, 8060R, 8020, 8000, 1000, 1941, 8045, 8050, 8030, 2271, 2272, 2284L, 228 4R, 2291L, 2291R, 2427, 2465, 10*, 1010*, 1800*, 1801* . See MDF-Raw in price grid for square foot pricing.

Molding Options (Chapter N)

1	Mullions and Applied Moldings on MDF	If ordering a Mullion Door or an Applied Molding on an MDF product, the molding will be constructed out of solid wood Maple - Hard / Soft Mixed - Paint Grade.
---	--------------------------------------	--

Sizes / Dimensions

1	Minimum W x H	Use the dimensions noted below the image of your chosen door style on the preceding pages.
2	Thickness	Available in ¾" [19.1mm] and 1" [25.4mm] thicknesses. 5-Piece MDF only available in ¾" [19.1mm] thickness.
3	5-Piece MDF - Max. Size	The maximum size for a 5-Piece MDF door will be 48" x 96" [1219.2mm x 2438.4mm] or 96" x 48" [2438.4mm x 1219.2mm].

► For PRICING ► See Section B.1 in our Wholesale Pricing Catalog.