

Contemporary Mortise & Tenon Doors

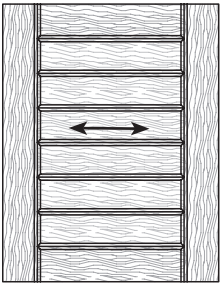

**Style: 1025**

PC: 505  
 Frame: PC505 x 0.6  
 Min. Size: 6x6  
 Max. Height: 29<sup>5</sup>/<sub>16</sub>  
 (If over the max. height,  
 order as a Style 1125)

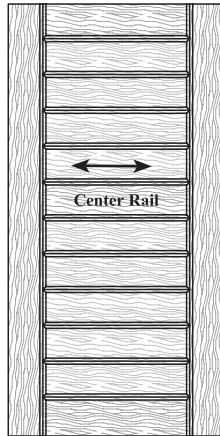

**Style: 1125**

PC: 507  
 Frame: PC507 x 0.6  
 Min. Size: 6x29<sup>3</sup>/<sub>8</sub>  
 Max. Height: 54<sup>7</sup>/<sub>8</sub>  
 (If over the max. height,  
 order as Style 2523)

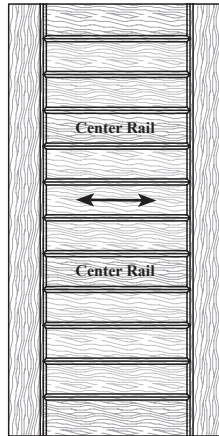

**Style: 2523**

PC: 511  
 Frame: PC511 x 0.6  
 Min. Size: 6x54<sup>15</sup>/<sub>16</sub>  
 Max. Height: 80<sup>7</sup>/<sub>8</sub>

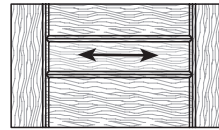

**Style: 1025\***  
 Drawer Front

PC: 505  
 Frame: PC505 x 0.6  
 Min. Size: 6x6  
 (Drawn at 8" high.)

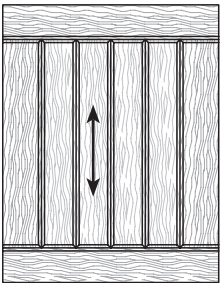

**Style: 2510**

PC: 504  
 Frame: PC504 x 0.6  
 Min. Size: 7x6  
 Max. Width: 30<sup>1</sup>/<sub>16</sub>  
 (If over the max. width,  
 order as a Style 2515)

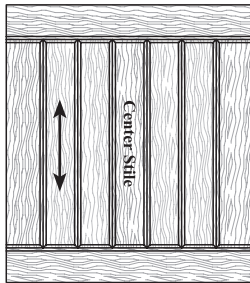

**Style: 2515**

PC: 508  
 Frame: PC508 x 0.6  
 Min. Size: 30<sup>1</sup>/<sub>8</sub>x15<sup>1</sup>/<sub>2</sub>

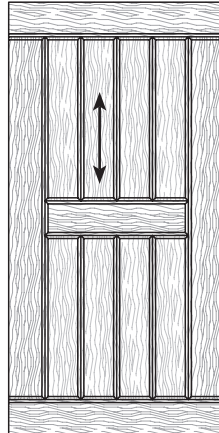

**Style: 2511**

PC: 506  
 Frame: PC506 x 0.6  
 Min. Size: 7x11<sup>1</sup>/<sub>4</sub>

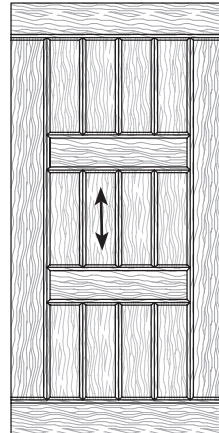

**Style: 2522**

PC: 512  
 Frame: PC512 x 0.6  
 Min. Size: 7x15<sup>3</sup>/<sub>4</sub>

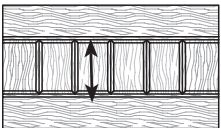

**Style: 2510\***  
 Drawer Front

PC: 504  
 Frame: PC504 x 0.6  
 Min. Size: 7x6  
 Max. Width: 30<sup>1</sup>/<sub>16</sub>  
 (If over the max. width,  
 order as a Style 2515\*)

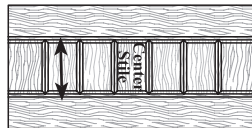

**Style: 2515\***  
 Drawer Front

PC: 508  
 Frame: PC508 x 0.6  
 Min. Size: 30<sup>1</sup>/<sub>8</sub>x6

► For PRICING ► See Section B9 in our Wholesale Pricing Catalog.

**Style 1025 Contemporary Mortise & Tenon**

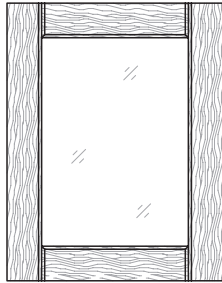

This is a view of our typical construction for a **Style 1025 Frame Door** with 2¼" stiles & rails, using stile and rail profile **SR116GRF**.

**Style 1025 Plank Sizes**

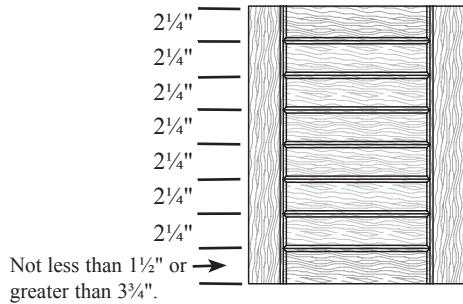

**Style 2510 Contemporary Mortise & Tenon**

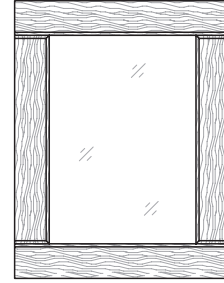

This is a view of our typical construction for a **Style 2510 Frame Door** with 2¼" stiles & rails, using stile and rail profile **SR116GRF**.

**Style 2510 Plank Sizes**

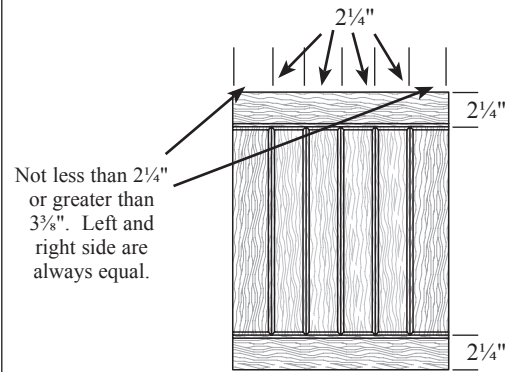

**Contemporary Mortise & Tenon Door Notes**

1) Pricing	See <b>Section B9</b> of the <b>Wholesale Pricing Catalog</b> .
2) Grain Direction	Arrows (←→) shown indicate standard grain direction. Grain direction may be specified at <b>NO</b> additional cost.
3) Mortise & Tenon	Allows for center panel expansion and contraction.
4) Profiles	Available with the <b>SR116 / PR314-06</b> or <b>SR149 / PR339-04</b> profile combinations. The <b>D21</b> Outside Edge matches the <b>SR116</b> and the <b>D32</b> or <b>D51</b> match the <b>SR149</b> .
5) Styles 1025 & 1125 (See above illustrations)	Bottom Rail dimension will vary depending on the height; the remaining stiles and rails will be 2¼" wide. When ordering stile & rail sizes other than 2¼" wide, plank sizes may be compromised requiring custom configuration. Additional charges may apply to customize configuration.
6) Styles 2510, 2511, 2515 (See above illustrations)	Left and right stile dimensions will vary depending on the overall width of door. The top and bottom rails will be 2¼" wide. When ordering stile sizes <b>other than noted in the illustration above</b> , plank sizes may be compromised requiring custom configuration. Additional charges may apply to customize configuration. Please check hinge bore placement compatibility when increasing the width of top and bottom rails.

► For PRICING ► See **Section B9** in our Wholesale Pricing Catalog.