

Distributed by:

WalzCraft[®]



Designs of distinction[®]
Kitchen, Bath & Home
by BWI

Materials and Components for Kitchen, Bath and Home.

TABLE OF CONTENTS



P.O. Box 1748, La Crosse, WI 54602-1748
2600 Hemstock St, La Crosse, WI
54603-2349

phone: 800-237-1326

fax: 608-781-3667

www.WalzCraft.com



www.x.com/WalzCraft



www.facebook.com/WalzCraft/



www.instagram.com/walzcraft/



www.pinterest.com/walzcraft/



©BROWN WOOD INC.
ALL RIGHTS RESERVED 2026
ALL DESIGNS ARE THE EXCLUSIVE PROPERTY OF
BROWN WOOD, INC. AND MAY NOT BE USED OR
REPRODUCED WITHOUT EXPRESS
WRITTEN PERMISSION

ii	INTRODUCTION MATERIALS AND FINISHES SECONDARY SERVICES
1	MATERIALS TAMBOUR NEW METAL ACCENTS CUT-TO-SIZE MATERIALS NEW
19	POSTS & TABLE LEGS
34	END PANELS & STEEL BASES NEW
41	BUN FEET
51	BRACKETS & CORBELS NEW
62	CREATE-A-COLUMN™ AND HALF ROUND MOULDING
66	DECORATIVE MOULDING & PILASTERS
68	SHELVING
72	OUTLETS & VENTS
77	CUSTOM PANEL INSERTS NEW
81	GALLERY RAIL
84	DECORATIVE BRASS HARDWARE NEW
89	INDEX & WARRANTY
94	Rigid Panel Warning
95	Samples and Sample Kits

ANODIZED ALUMINUM

We use a special Aluminum alloy to create our decorative aluminum accents. This special alloy can be chemically brightened. Our Aluminum finishes are anodized and feature bright chromes, soft satins and deep matte finishes. Anodizing is considered the best method of finishing in order to achieve a true metallic look. Anodized finishes are extremely durable and will not flake, peel or fade.

If exact color is critical to your project, please request color samples.



CR: Chrome



WB: Warm Bronze

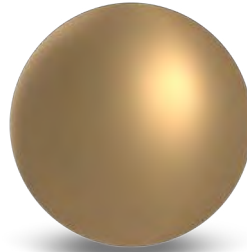

SB: Satin Brass



PB: Polished Brass



WR: Flat Black



BA: Brushed Aluminum



SS: Satin Stainless



TM: Titanium

SOLID BRASS

Cast brass, made of a copper/zinc alloy, is known for its material integrity, smooth surface finish, durability, and strength.

Cast brass Feet & Slipper Cups will outlast normal wear and will maintain its bright finish for years to come.

AB: Antique Brass



WR: Flat Black



PB: Polished Brass

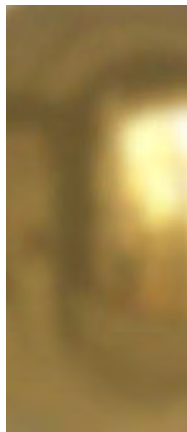

CR: Chrome



SB: Satin Brass



WOOD SPECIES

We source only the finest FAS (First and Seconds) hardwoods for our products. The majority of our products are made from laminated blocks with more than one glue line. We strive to provide the best possible color match between staves, but variations may occur. Variations in color and grain pattern are natural characteristics of wood and are not considered defects.



AL: Alder

CH: Cherry

MDF: Medium-Density
Fiberboard

HM: Hard Maple

AK: Red Oak

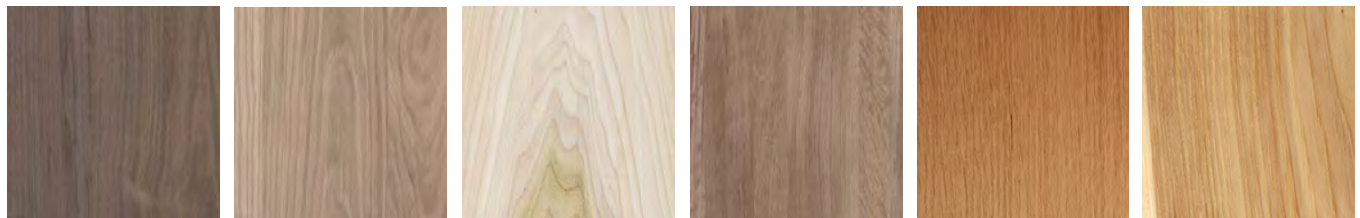

WL: Walnut

WK: White Oak

PT: Paint Grade

QW: Quarter Sawn
White Oak

QS: Quarter Sawn
Red Oak

HK: Hickory

ELECTROPLATED WIRE GRILLE FINISHES

Our electroplated Decorative Grilles are hand woven & crimped from superior steel wire. The process of electroplating deposits metal finishes onto the steel through electricity creating both bright and antique finishes. Finishes can vary from run to run. **If exact color is critical to your project, please request samples. Sample Kits available on our website.**

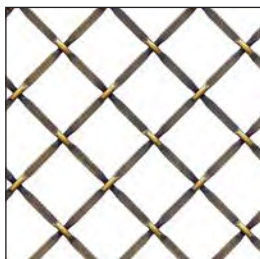

AB: Antique Brass

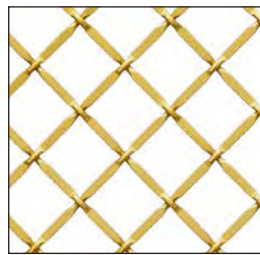

SB: Satin Brass

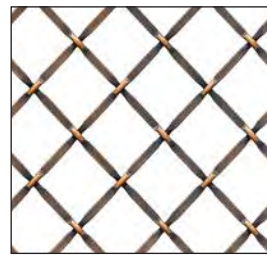

AC: Antique Copper



AP: Antique Pewter



SN: Polished Satin Nickel

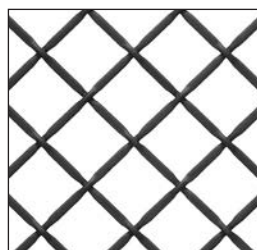

WR: Flat Black

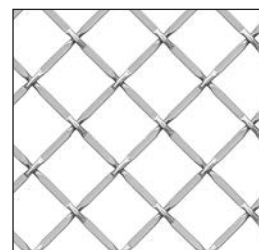

SS: Stainless Steel Look

SPECIAL WOOD CUTS & SECONDARY SERVICES

We are pleased to offer several options to help you in your design process. Secondary services such as splitting in half, quarter notching, electrical outlet notching, and hanger bolt installation are available on the majority of our columns, legs and bun feet. Additional charges apply.

QUARTER CUT



01QUARTERNOTCH

Quarter notching creates a single quartered piece and a single 3/4 piece. Both pieces are included in purchase.

SPLIT



01SPLITCOLUMN

Split column in half. 1/8" of thickness may be lost due to saw kerf. Both halves are included in purchase.

ANGLE CUT



01ANGLECUT

Product is cut at an angle from corner to corner, full length only. Both pieces are included in purchase.

STOP NOTCH



01STOPNOTCH

Stop notch a column. Let us know how far down you would like notched.

SPLIT BUN FOOT



01SPLITFEET

Split bun foot in half. Both pieces are included in purchase.

HANGER BOLT



01HANGERBOLT

5/16-18 hanger bolt installed in one end. Hanger bolt installed to protrude 1/2".

BOX ROUTE



01BXROUTE

Add an electrical box to your column.

ELECTRICAL BORE



01ELECBORE

A 1/2" hole the entire length of the column.

MOULDING & TAMBOUR TRIM

We will cut your 96" moulding to 92" to reduce shipping costs.



*Please note - not all items can be cut in all the formats above, nor can all columns receive an Electrical Box Notch.
All custom cut products are non-returnable.

This page intentionally left blank.



**MATERIALS: FLEXIBLE TAMBOUR
& RIGID BEADED PANELS**

FLEXIBLE TAMBOUR PANELS

Made in the USA. Our thin material backer allows Flexible Panels to be used as a wrap as well as flat applications. Flexible beaded panels consist of individual staves, glued to a flexible canvas or paper backer. Suitable for residential and commercial applications. Unfinished American Hardwoods can be easily stained or painted in colors and finishes of your choice.

For **onlay** applications - such as walls, hoods, or cabinet wraps. 48" and 96" lengths in stock. Custom sizes available.

Stock finishes in: Red Oak (AK), Hard Maple (HM), Paint Grade Poplar (PT), Walnut (WL) & White Oak (WK).
To order, refer to the style numbers listed below.



STYLE 100	STYLE 101	STYLE 102
<p>011248100-1 12"W x 48"L x .25"T 011296100-1 12"W x 96"L x .25"T 012448100-1 24"W x 48"L x .25"T</p>	<p>011248101-1 12"W x 48"L x .313"T 011296101-1 12"W x 96"L x .313"T</p>	<p>011248102-1 12"W x 48"L x .375"T 011296102-1 12"W x 96"L x .375"T 012448102-1 24"W x 48"L x .375"T</p>
STYLE 103	STYLE 104	STYLE 105
<p>011248103-1 12"W x 48"L x .313"T 011296103-1 12"W x 96"L x .313"T</p>	<p>011248104-1 12"W x 48"L x .5"T 011296104-1 12"W x 96"L x .5"T</p>	<p>011248105-1 12"W x 48"L x .375"T 011296105-1 12"W x 96"L x .375"T</p>
STYLE 106	STYLE 107	STYLE 110
<p>011248106-1 12"W x 48"L x .75"T 011296106-1 12"W x 96"L x .75"T</p>	<p>011248107-1 12"W x 48"L x .375"T 011296107-1 12"W x 96"L x .375"T 012448107-1 24"W x 48"L x .375"T 012434107-1 24"W x 34"L x .375"T</p>	<p>011248110-1 12"W x 48"L x .25"T 011296110-1 12"W x 96"L x .25"T 012448110-1 24"W x 48"L x .25"T</p>

MATERIALS

AK: Red Oak	HM: Hard Maple	MDF: Medium Density Fiberboard	PT: Paint Grade	WL: Walnut	WK: White Oak
-----------------------	--------------------------	---	---------------------------	----------------------	-------------------------

FLEXIBLE TAMBOUR PANELS

Made in the USA. Our thin material backer allows Flexible Panels to be used as a wrap as well as flat applications. Flexible beaded panels consist of individual staves, glued to a flexible canvas or paper backer. Suitable for residential and commercial applications. Unfinished American Hardwoods can be easily stained or painted in colors and finishes of your choice.

For **onlay** applications - such as walls, hoods, or cabinet wraps. 48" and 96" lengths in stock. Custom sizes available.

Stock finishes in: Red Oak (AK), Hard Maple (HM), Paint Grade Poplar (PT), Walnut (WL) & White Oak (WK).
To order, refer to the style numbers listed below.

SQUARE

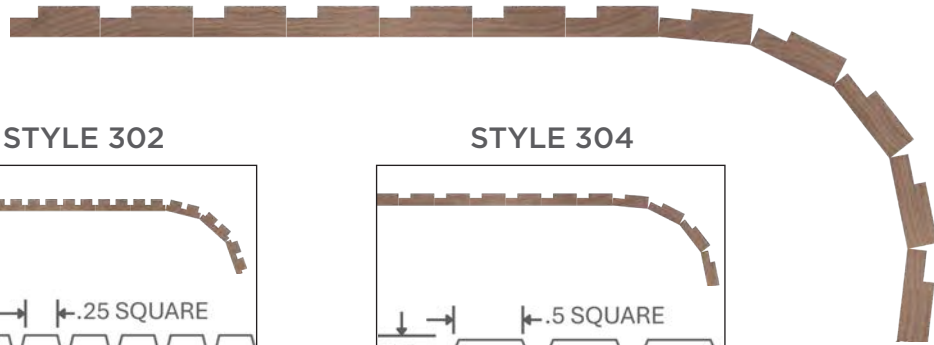

STYLE 302

011248302-1
12"W x 48"L x .25"T
011296302-1
12"W x 96"L x .25"T
012448302-1
24"W x 48"L x .25"T

STYLE 304

011248304-1
12"W x 48"L x .25"T
011296304-1
12"W x 96"L x .25"T
012448304-1
24"W x 48"L x .25"T

COVE

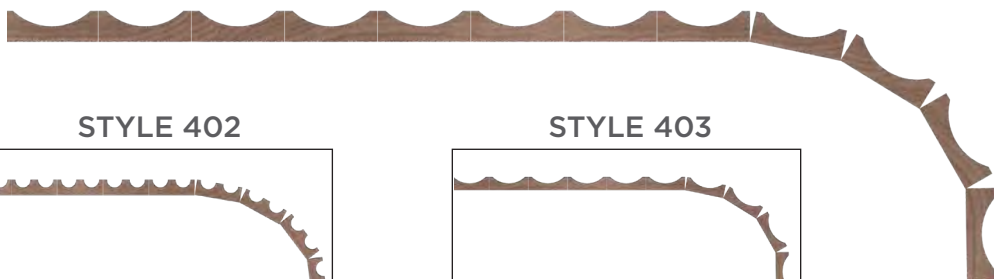

STYLE 402

011248402-1
12"W x 48"L x .25"T
011296402-1
12"W x 96"L x .25"T
012448402-1
24"W x 48"L x .25"T

STYLE 403

011248403-1
12"W x 48"L x .25"T
011296403-1
12"W x 96"L x .25"T
012448403-1
24"W x 48"L x .25"T

FLEXIBLE TAMBOUR PANELS

Made in the USA. Our thin material backer allows Flexible Panels to be used as a wrap as well as flat applications. Flexible beaded panels consist of individual staves, glued to a flexible canvas or paper backer. Suitable for residential and commercial applications. Unfinished American Hardwoods can be easily stained or painted in colors and finishes of your choice.

For **onlay** applications - such as walls, hoods, or cabinet wraps. 48" and 96" lengths in stock. Custom sizes available.

Stock finishes in: Red Oak (AK), Hard Maple (HM), Paint Grade Poplar (PT), Walnut (WL) & White Oak (WK).
To order, refer to the style numbers listed below.

BEVEL

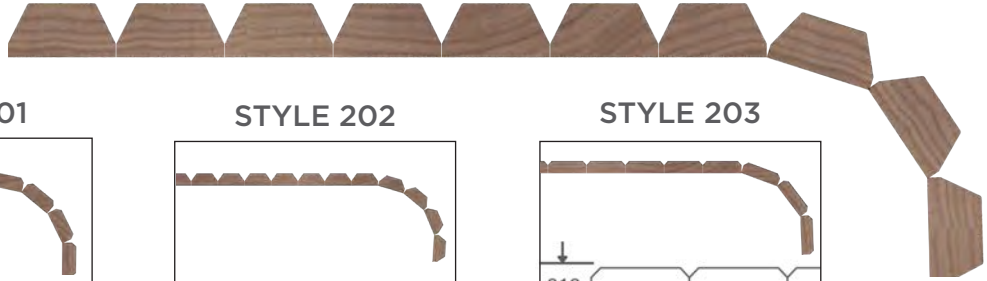

STYLE 201

011248201-1
12"W X 48"L X .313"T
011296201-1
12"W X 96"L X .313"T

STYLE 202

011248202-1
12"W X 48"L X .344"T
011296202-1
12"W X 96"L X .344"T

STYLE 203

011248203-1
12"W X 48"L X .313"T
011296203-1
12"W X 96"L X .313"T
012448203-1
24"W X 48"L X .313"T
012434203-1
24"W X 34"L X .313"T

STYLE 204

011248204-1
12"W X 48"L X .5"T
011296204-1
12"W X 96"L X .5"T

STYLE 206

011248206-1
12"W X 48"L X .5"T
011296206-1
12"W X 96"L X .5"T

STYLE 207

011248207-1
12"W X 48"L X .75"T
011296207-1
12"W X 96"L X .75"T



RIGID PANELS

Multiple styles work with both furniture and architectural applications. Unfinished, ready to stain or paint. **Red Oak (AK), Hard Maple (HM), Paint Grade Brown Maple (PT), Walnut (WL) & White Oak (WK).** 46" and 96" lengths in stock. **Some Styles Available In: Cherry, Alder, Hickory, HDF, Quarter Sawn White Oak & Quarter Sawn Red Oak.**

[Click here for Warranty Disclaimer](#)

BEAD

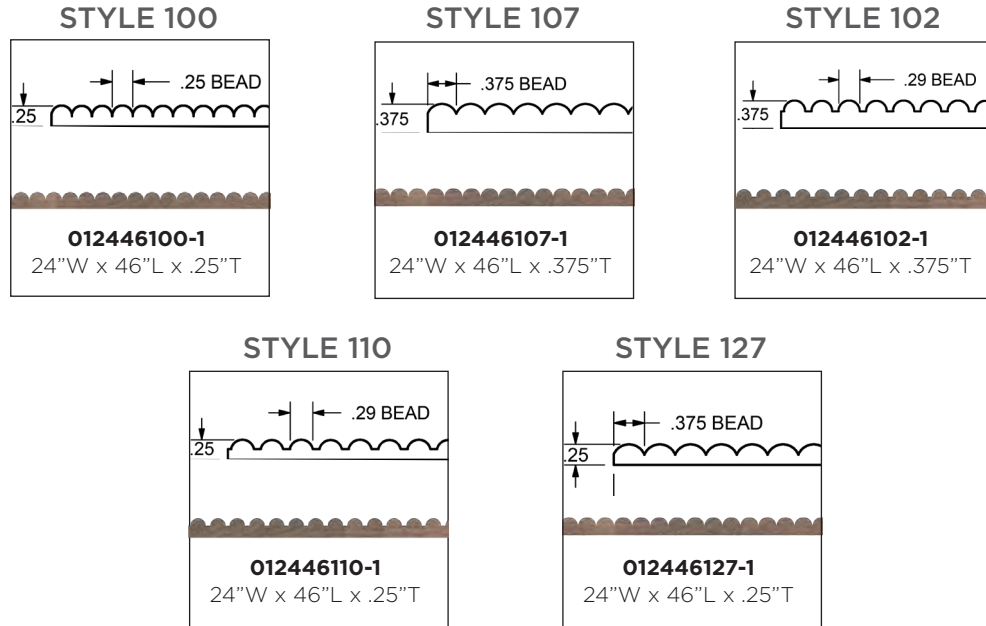

SQUARE

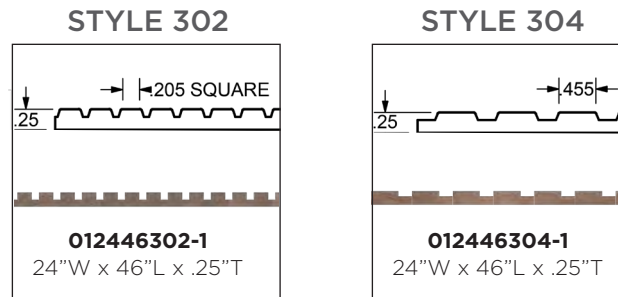

COVE

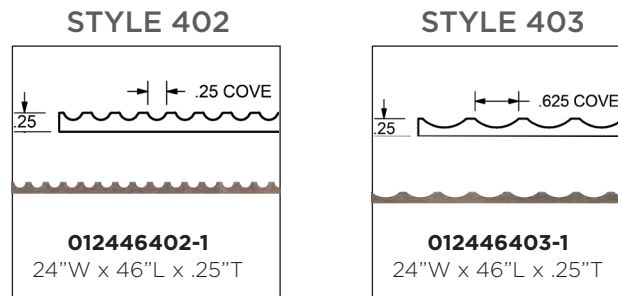

MATERIALS

NEW! 3/4" T x 96" L x 48" W CROSS-GRAIN VENEER BACKED BEADED PANEL

Full Size Rigid Panels combine tambour texture with engineered stability in a 3/4" panel designed for cabinetry, millwork, and architectural applications.

Balanced & Stable Construction - Cross-grain hardwood veneer backer and 1/2" plywood core minimize warping, cupping, and seasonal movement while maintaining strength without excess weight.

Beaded Face with Visual Texture - Tambour detailing adds depth and dimension, complementing design styles from traditional to contemporary.

Standard 3/4" Thickness - Integrates seamlessly into standard cabinetry and millwork with no special hardware or joinery adjustments.

Finished Back for Exposed Applications - Veneer backer provides a clean, finished appearance for islands, open shelving, and freestanding installations.

Efficient, Cost-Effective Design - Combines the beauty of solid wood with an engineered core for responsible material use and premium value.

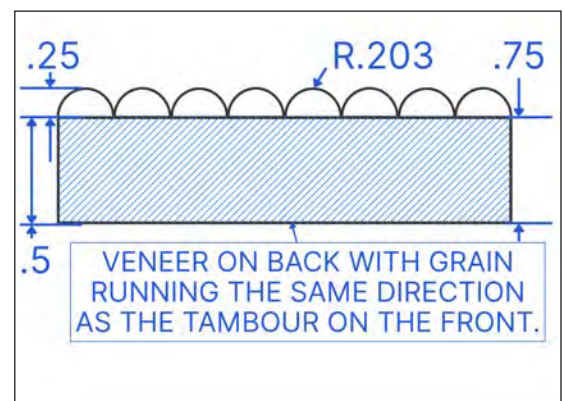

MATERIALS



MATERIALS: METAL ACCENT TRIM

Image: .25" x .25" Decorative Bar style #01110810

METAL ACCENT TRIM



PICTURED: Designer DripEdge® and .25" x .25" Aluminum Bar

DESIGNER DRIPEDGE®

Fits standard waste can cabinets from 12" to 24".
Features eased ends and includes pre-applied UHB tape for easy installation.

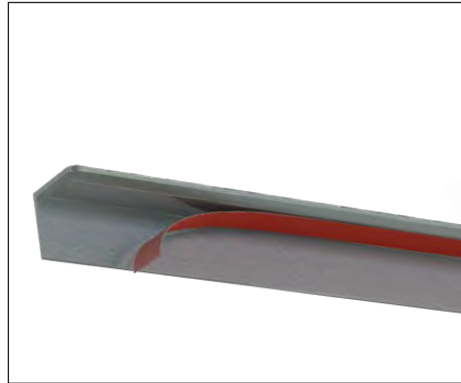
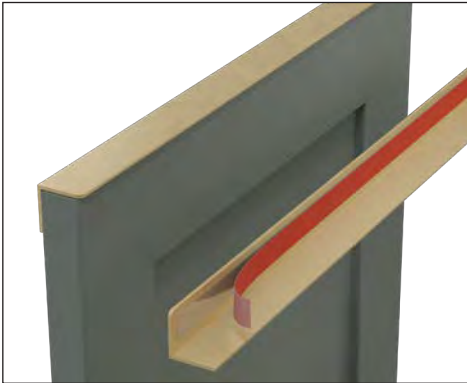

010451-1-1181 11.8125" Long	010451-1-1875 18.75" Long
01110451-1-12 12.75" Long	010451-1-2050 20.50" Long
01110451-1-14 14.50" Long	010451-1-2081 20.8125" Long
010451-1-1481 14.8125" Long	010451-1-2175 21.75" Long
01110451-1-15 15.75" Long	010451-1-2350 23.50" Long
01110451-1-17 17.50" Long	010451-1-2384 23.844" Long
010451-1-1781 17.8125" Long	Sample Kit 01DripEdgeCLR

ALUMINUM TOUCH-UP PEN



- 01PENWR1**
Flat Black (WR)
- 01PENBR1**
Polished Brass (PB)
& Satin Brass (SB)
- 01PENST1**
Satin Stainless (ST)
- 01PENTM1**
Titanium (TM)
- 01PENWB1**
Warm Bronze (WB)

BA & CR do not have touch-up pens

UHB TAPE



01TP50-108
1/2" x 108"

01TP1875-54
3/16" x 54"

01TP50-8
1/2" x 8'

01TP1875-8
3/16" x 8'

ALUMINUM BARS

Available in 72" lengths, the straps can be cut on-site to fit your specifications using a lubricated, non-ferrous, high tooth count carbide blade (96 is recommended) designed for cutting metal. We stock strong, double-sided, clear industrial tape that's temperature resistant to adhere metal trim to mouldings and cabinet panels. Metallic Trim stocked in **Brushed Aluminum (BA)**, **Chrome (CR)**, **Flat Black (WR)**, **Polished Brass (PB)**, **Satin Brass (SB)**, **Satin Stainless (ST)**, **Titanium (TM)** & **Warm Bronze (WB)**.



ALUMINUM ANGLED BARS

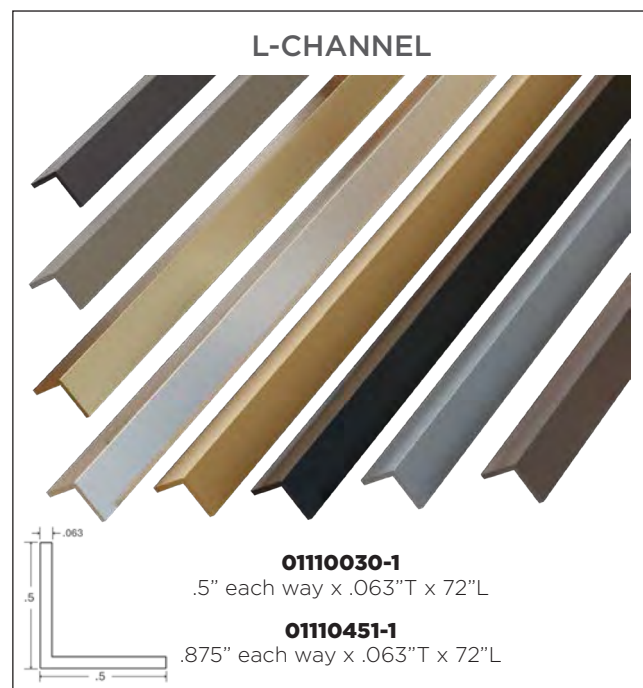

MATERIALS

BA:
Brushed
Aluminum

CR:
Chrome

PB:
Polished Brass

SB:
Satin Brass

ST:
Satin Stainless

TM:
Titanium

WB:
Warm Bronze

WR:
Flat Black

ALUMINUM STRAPPING

Metallic Trim Accents stocked in 72" lengths: **Brushed Aluminum (BA)**, **Chrome (CR)**, **Flat Black (WR)**, **Polished Brass (PB)**, **Satin Brass (SB)**, **Satin Stainless (ST)**, **Titanium (TM)** & **Warm Bronze (WB)**.

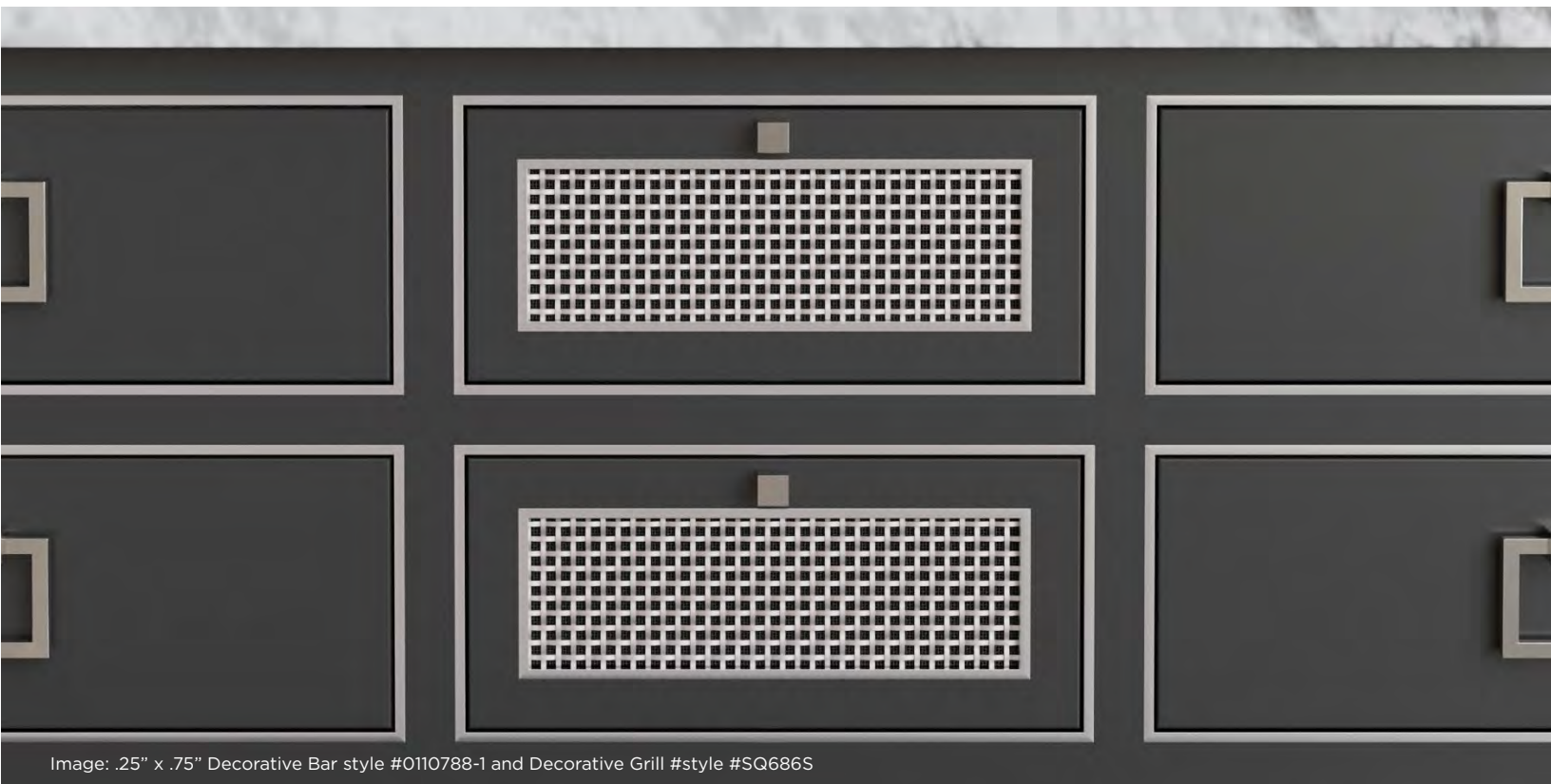
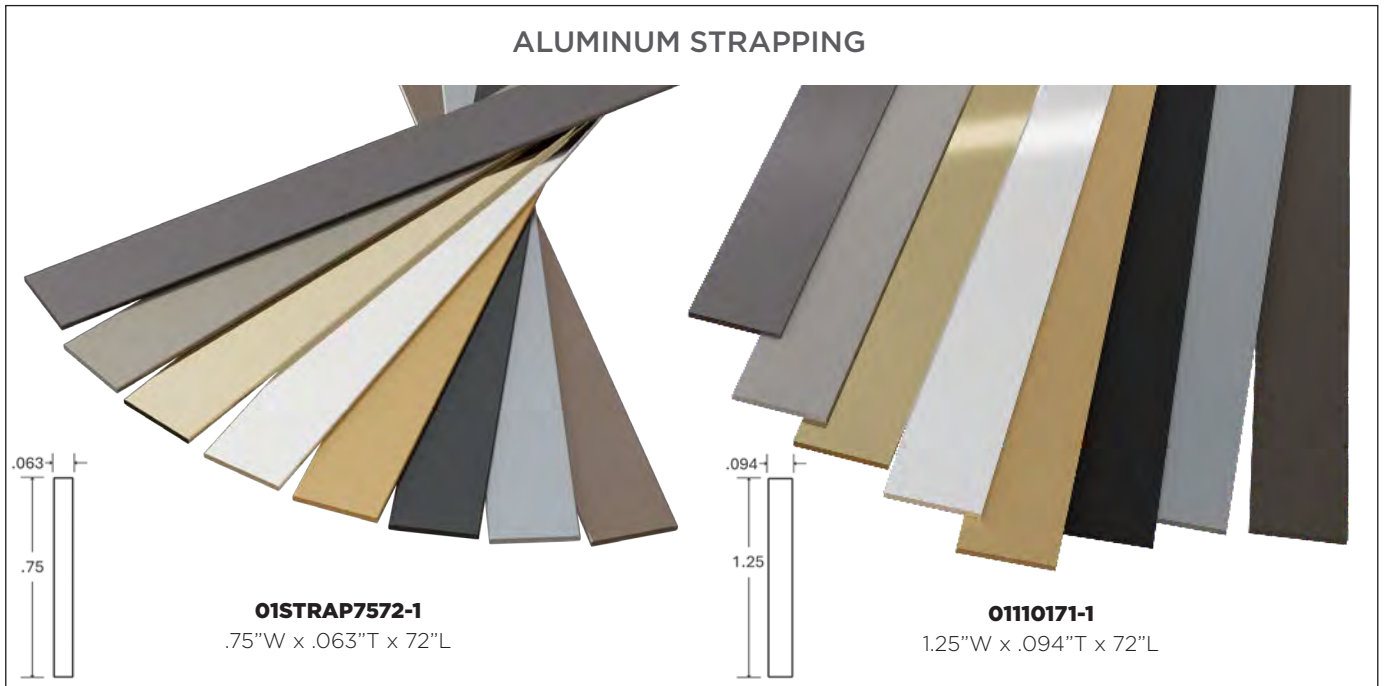

MATERIALS

10	BA: Brushed Aluminum	CR: Chrome	PB: Polished Brass	SB: Satin Brass	ST: Satin Stainless	TM: Titanium	WB: Warm Bronze	WR: Flat Black
----	--------------------------------	----------------------	------------------------------	---------------------------	-------------------------------	------------------------	---------------------------	--------------------------

BRASS TRIM COMPONENTS



1/2" Brass Corner Strap in PN #01HC1005-1

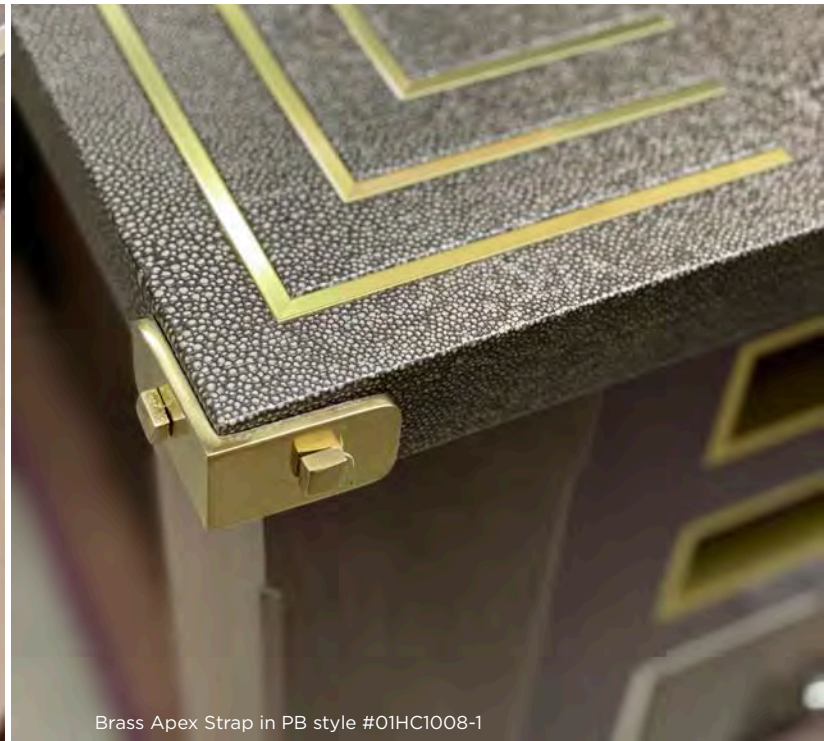

Brass Apex Strap in PB style #01HC1008-1

1/2" BRASS CORNER STRAP



01HC1005-1
1.5" Each Way x .08"T
Available in PB & PN

1/2" BRASS STRAP CONNECTOR



01HC1010-1
.512"W x .08"T x 2"L
Available in PB & PN

BRASS APEX STRAP



01HC1008-1
2" Each Way x .197"T x 1.181"H
Available in AB, CR, PB, PN, SB, WR

1/4" BRASS BAR

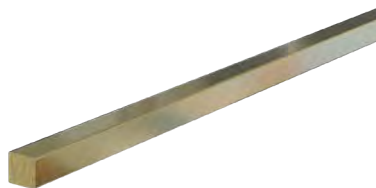

01990810-1
.25" SQ. x 72" L
Available in PB & SB

3/8" BRASS STRAP



01HC1007-1
.375"W x .063"T x 48"L
Available in PB & PN

MATERIALS

AB:
Antique Brass

CR:
Chrome

PB:
Polished Brass

PN:
Polished Satin
Nickel

SB:
Satin Brass

WR:
Flat Black

MATERIALS: CUT-TO-SIZE



CUT-TO-SIZE MATERIALS

Sold by the square or linear foot (LF).



Image: Decorative Grille style #332P layered with mesh

Decorative Grilles available in **Antique Brass (AB)**, **Antique Copper (AC)**, **Antique Pewter (AP)**, **Satin Brass (SB)**, **Polished Satin Nickel (SN)**, **Stainless Look (SS)** & **Flat Black (WR)**. Finishes created through an electroplating process. To order Cut-to-Size panels that are ready to install upon delivery, contact us by sending an order form available on our website with your panel specifications and a quote will be provided based on square footage. Sample Kits are available.

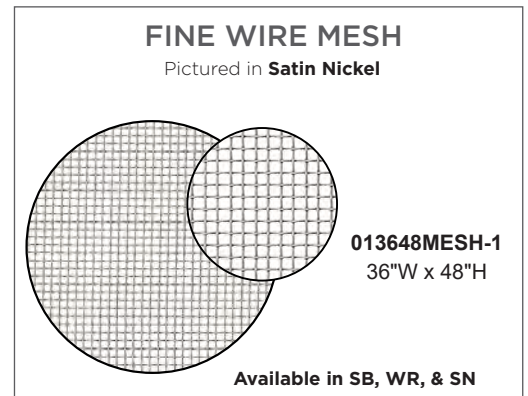
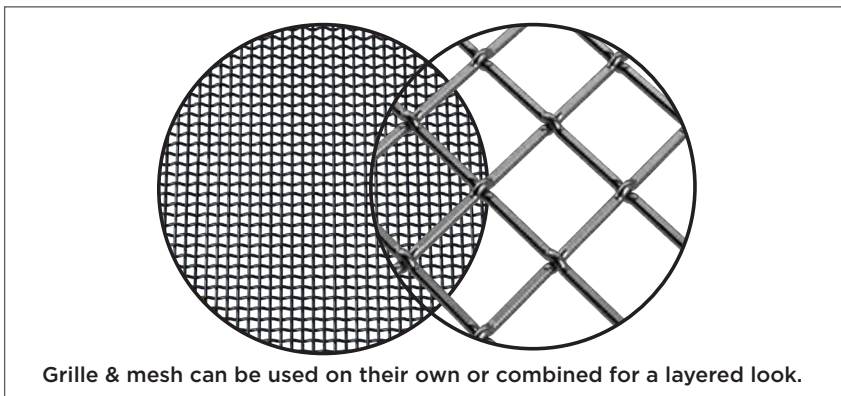

MATERIALS

AB:
Antique Brass

AC:
Antique Copper

AP:
Antique Pewter

SB:
Satin Brass

SN:
Satin Nickel

SS:
Stainless Look

WR:
Flat Black

DIAMOND DECORATIVE GRILLE

Decorative Grilles are available in **Antique Brass (AB), Antique Copper (AC), Antique Pewter (AP), Natural Aluminum (NA), Satin Brass (SB), Polished Satin Nickel (SN), Stainless Look (SS), Warm Bronze (WB) & Flat Black (WR)** unless otherwise noted. Available Cut-to-Size or as full and half sheets. Custom styles and finishes available upon request.

NEW!

#M22
.375" Flat Crimped Double Diamond
 Pictured in **Antique Brass, 2-sided**
 Front



013648M22-1
 36"W x 48"H

012472M22-1
 24"W x 72"H

Back

Available in AB, SB, SN, & WR

NEW!

#226
.05" Flat Rigid Aluminum Grille
 Pictured in **Natural Aluminum**

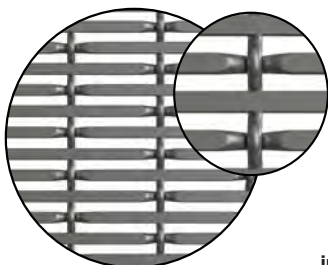

013648226-1
 36"W x 48"H

012472226-1
 24"W x 72"H

Only Available in NA, WB, & WR

#332P
.75" Multi-Crimp Single Diamond
 Pictured in **Antique Pewter**

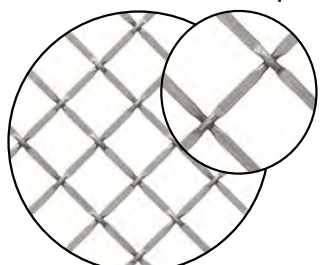

013648332P-1
 36"W x 48"H

012472332P-1
 24"W x 72"H

#CG10
.5" Straight Flat Diamond
 Pictured in **Antique Brass**



013648CG10-1
 36"W x 48"H

012472CG10-1
 24"W x 72"H

#286S
.375" Flat Single Diamond
 Pictured in **Polished Satin Nickel**

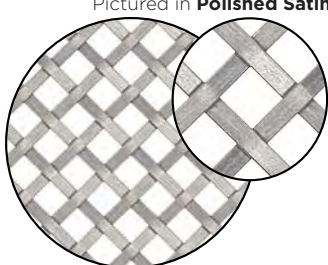

013648286S-1
 36"W x 48"H

012472286S-1
 24"W x 72"H

#DK08
Double-Sided .375" Flat/Fluted
 Pictured in **Satin Brass, 2-Sided**

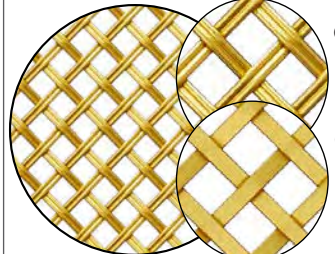

013648DK08-1
 36"W x 48"H

012472DK08-1
 24"W x 72"H

#11614P
1" Flat Double Diamond
 Pictured in **Flat Black**

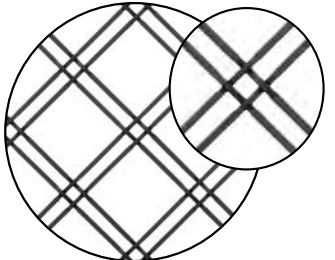

01364811614P-1
 36"W x 48"H

01247211614P-1
 24"W x 72"H

#1214F
.5" Round Single Diamond
 Pictured in **Antique Copper**

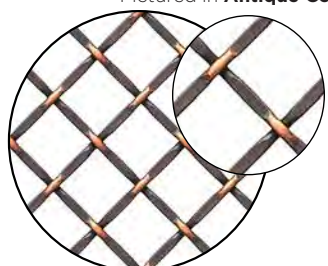

0136481214F-1
 36"W x 48"H

0124721214F-1
 24"W x 72"H

#1220T
.5" Chicken Wire
 Pictured in **Antique Pewter**

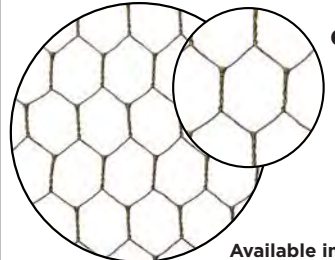

0136481220T-1
 36"W x 48"H

0124721220T-1
 24"W x 72"H

Available in AB, AP and WR.

#R332P
.75" Multi-Crimp Single Diamond with .5" Rosettes



013648R332PAB1
 36"W x 48"H

Only Available in Antique Brass

#R614P
1" Flat Double Diamond w/ .625" Diameter Rosettes



013648R614PAB1
 36"W x 48"H

Only Available in Antique Brass

#315C
.75" Pressed Single Diamond
 Pictured in **Polished Satin Nickel**



013648315C-1
 36"W x 48"H

012472315C-1
 24"W x 72"H

MATERIALS

SQUARE DECORATIVE GRILLE

Most Decorative Grilles are available in **Antique Brass (AB)**, **Antique Copper (AC)**, **Antique Pewter (AP)**, **Satin Brass (SB)**, **Polished Satin Nickel (SN)**, **Stainless Look (SS)** & **Flat Black (WR)** unless otherwise noted. Available Cut-to-Size or as whole and half sheets. Custom styles and finishes available upon request.

#SQ214F
.5" Round Single Square
 Pictured in **Stainless Look**

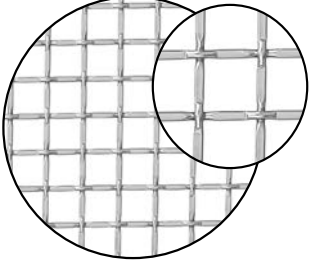

01SQ3648214F-1
 36" W x 48" H

01SQ2472214F-1
 24" W x 72" H

#SQ286S
.375" Flat Single Square
 Pictured in **Satin Brass**



01SQ3648286S-1
 36" W x 48" H

01SQ2472286S-1
 24" W x 72" H

#SQDK08
Double-Sided .375"
 Pictured in **Antique Brass**



01SQ3648DK08-1
 36" W x 48" H

01SQ2472DK08-1
 24" W x 72" H

#SQ332P
.75" Multi-Crimp Single Square
 Pictured in **Antique Brass**

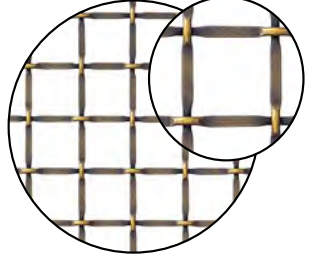

01SQ3648332P-1
 36" W x 48" H

01SQ2472332P-1
 24" W x 72" H

#SQRE25
.1875" Flat Square
 Pictured in **Satin Brass**



013648RE25-1
 36" W x 48" H

012472RE25-1
 24" W x 72" H

Wire Mesh Style #	Cut-to-Size Part #
#M22	M22-1
#226	226-1
#332P	332P-1
#CG10	CG10-1
#286S	286S-1
#DK08	DK08-1
#11614P	11614P-1
#1214F	1214F-1
#1220T	1220T-1
#R332P	R332PAB1
#R614P	R614PAB1
#315C	315C-1
#SQ214F	SQ214F-1
#SQ286S	SQ286S-1
#SQDK08	SQDK08-1
#SQ332P	SQ332P-1
#SQRE25	RE25-1
#MESH	MESH-1

MATERIALS

AB:
Antique Brass

AC:
Antique Copper

AP:
Antique Pewter

SB:
Satin Brass

SN:
Satin Nickel

SS:
Stainless Look

WR:
Flat Black

ITALIAN MESH

Made in Italy.

Sold by the linear foot (LF), minimum order of 59" wide x 1 LF.

NEW!
INTERLACE STRIPE MESH
Available in **CP, PB, SS**

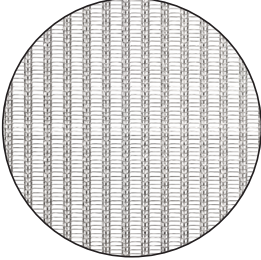

Style #103
01103CP
01103PB
01103SS

NEW!
SUPERFINE WIRE MESH
Available in **CP, SB, SS**

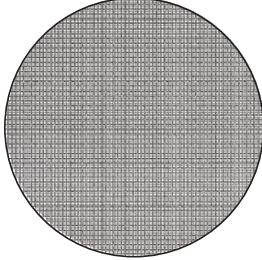

Style #110
01110CP
01110SB
01110SS

CHEVRON MESH
Available in **CP, SB, SS**

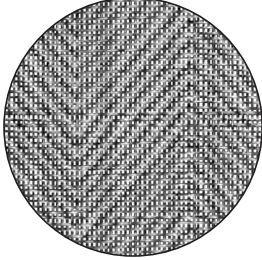

Style #107
01107CP
01107SB
01107SS

JUTE MESH
Available in **SS**

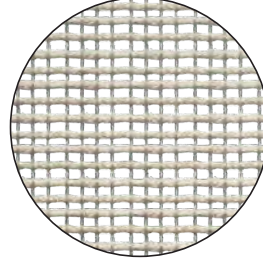

Style #112
01112SS

RESIN PANELS

Sold by the linear foot (LF), minimum order of 48" wide x 1 LF.

WHITE LINEN



Style #1803
011803

BOTANICAL



Style #1804
011804

NATURAL LEAF



Style #1802
011802

RATTAN WEBBING

Sold by the linear foot (LF), minimum order of 36" wide x 1 LF.

NEW! SYNTHETIC RATTAN WEBBING

Our new synthetic rattan webbing combines timeless woven design with modern durability. Manufactured from high-quality polyethylene (PE) granules, this material offers exceptional strength while remaining practically maintenance-free. Unlike natural rattan, it resists fading, warping, or weakening from temperature and humidity changes, ensuring long-lasting structure and performance. 36"W rolls. Available in Natural (NT) or Black (WR).

HEX RATTAN

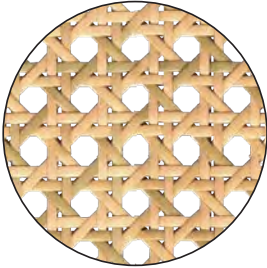

Style #3202NT
013202NT

HEX RATTAN

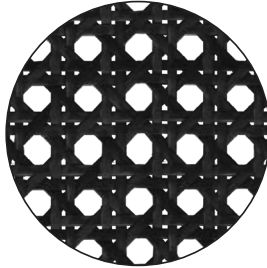

Style #3202WR
013202WR

RADIO WEAVE

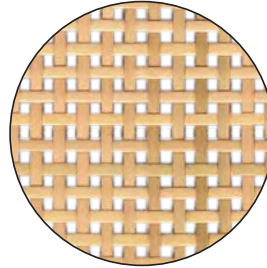

Style #3201NT
013201NT

RADIO WEAVE

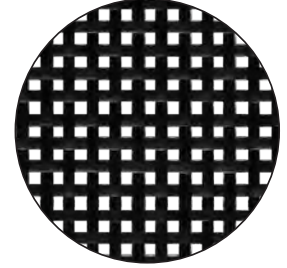

Style #3201WR
013201WR

NATURAL RATTAN WEBBING

Handwoven from rattan cane, this material offers a lightweight yet durable construction. Over time, it develops a rich patina, adding to its authenticity and charm. Because it is a natural fiber, rattan is responsive to its environment. Gradually, it may stretch, lose some of its original tension, or change shape, particularly in areas exposed to heat, humidity, or fluctuating moisture levels. 36"W rolls.

HEX RATTAN

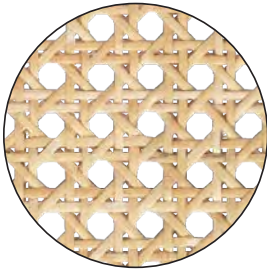

Style #1202NT
011202NT

HERRINGBONE

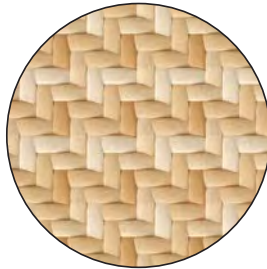

Style #1203NT
011203NT

BASKETWEAVE

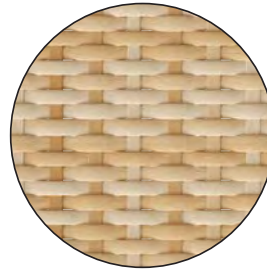

Style #1204NT
011204NT

RADIO WEAVE

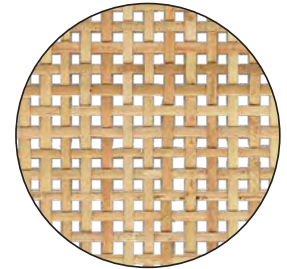

Style #1201NT
011201NT



Image: Hex Rattan Style #3202/#1202

ECO-FRIENDLY LEATHER

NEW! PEEL & STICK LEATHER SHEETS

Sold by the linear foot (LF), minimum order of 48" wide x 1 LF.

GRAINED FLAT BLACK



Style #3216WR
013216WR

CROCODILE FLAT BLACK



Style #5618WR
015618WR

PEBBLED WALNUT

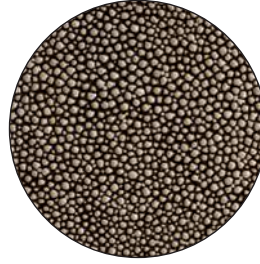

Style #2652WL
012652WL

PEBBLED FLAT BLACK

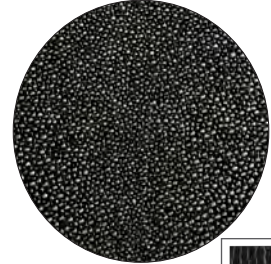

Style #2652WR
012652WR



Adhesive Back

DOUBLE-SIDED PEBBLED LEATHER PANEL

Sold by the linear foot (LF), minimum order of 48" wide x 1 LF.

BRIGHT WHITE

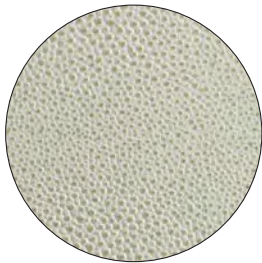

Style #1652BW
011652BW

WALNUT

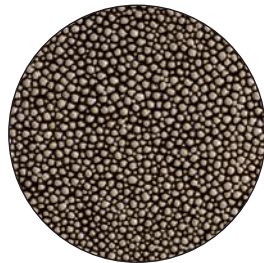

Style #1652WL
011652WL

ESPRESSO

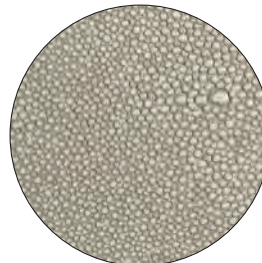

Style #1652ES
011652ES

FLAT BLACK



Style #1652WR
011652WR

DOUBLE-SIDED GRAINED LEATHER PANEL

Sold by the linear foot (LF), minimum order of 48" wide x 1 LF.

BRIGHT WHITE



Style #2216BW
012216BW

WALNUT



Style #2216WL
012216WL

ESPRESSO



Style #2216ES
012216ES

FLAT BLACK



Style #2216WR
012216WR



POSTS & TABLE LEGS

Image: Square Island Posts with Chamfered Detail

18" - 29" TABLE LEGS

-6: includes a pre-installed 5/16-18 hanger bolt protruding .75"

ROUND TAPERED



01243029-1
2.25" Diam. x 29"H



01243024-6
1.87" Diam. X 24"H



01243018-6
1.87" Diam. X 18"H

PERLE



01245129-1
4.625" Diam. x 29"H



01245124-1
4.625" Diam. X 24"H



01245118-1
3.75" Diam. X 18"H

29" SQUARE TABLE LEGS

-3: indicates notching in the leg

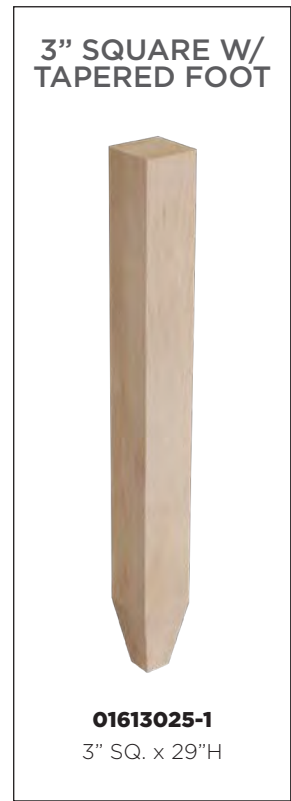
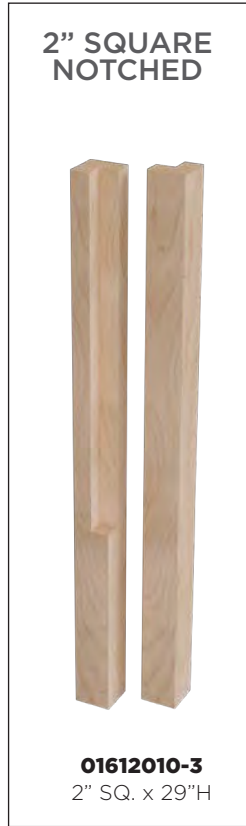

POSTS & LEGS

AK:
Red Oak

AL:
Alder

CH:
Cherry

HM:
Hard Maple

HK:
Hickory

PT:
Paint Grade





WK:
White Oak

WL:
Walnut



29" TABLE LEGS

<p>3" SQUARE LEG W/ METAL SLEEVE</p>  <p>01723001-1 3" SQ. x 29"H with 3" SQ. sleeve</p>	<p>3" SQUARE LEG W/ METAL SLEEVE</p>  <p>01734529-1 3" SQ. x 29"H with 3" x 4.5" SQ. sleeve</p>	<p>4" SQUARE COLUMN W/ METAL SLEEVE</p>  <p>01724001-1 4" SQ. x 29"H with 4" SQ. sleeve</p>	<p>4" SQUARE</p>  <p>01614010-1 4" SQ. x 29"H</p>	<p>4" SQUARE W/ TAPERED FOOT</p>  <p>01614025-1 4" SQ. x 29"H</p>
---	--	--	--	--



29" TURNED TABLE LEGS

<p>ESTATE SQUARE</p>  <p>01040127-1 2.75" SQ. x 29.25"H</p>  <p>01040160-1 3.75" SQ. x 29.25"H</p>  <p>01220160-1 5" SQ. x 29.25"H</p>			<p>KENSINGTON</p>  <p>01110110-1 3" SQ. x 29"H</p>	<p>COUNTRY FRENCH SQUARE</p>  <p>01060160-1 3.75" SQ. x 29.25"H</p>
---	--	--	--	--

29" TURNED TABLE LEGS

COUNTRY FRENCH		GAELIC			ENGLISH COUNTRY	
						
01060110-1 3.75" Diam. x 29.25"H	01510110-1 5" Diam. x 29.25"H	01590122-1 3.5" Diam. x 29"H	01590124-1 4.5" Diam. x 29"H	01590127-1 6" Diam. x 29"H	01000110-1 3.75" Diam. x 29.25"H	01210110-1 5" Diam. x 29.25"H

MOUNTING PLATES FOR 5/16-18" HANGER BOLTS

<p>11-DEGREE ANGLE MOUNTING PLATE</p>  <p>01ANGLEPLATE 2.375" SQ x .286" T</p>	<p>STRAIGHT MOUNTING PLATE</p>  <p>01STRAIGHTPLATE 2.375" SQ x .286" T</p>	<p>HEAVY DUTY PLATE</p>  <p>01HDPLATE 4.151" x 5.469" x .286" T</p>
---	---	--

POSTS & LEGS

AK:
Red Oak

AL:
Alder

CH:
Cherry

HM:
Hard Maple





HK:
Hickory





PT:
Paint Grade

WK:
White Oak

WL:
Walnut

34.5" - 36.5" SQUARE ISLAND POSTS

<p>2" SQUARE COLUMN W/ METAL SLEEVE</p>  <p>01724500-1 2" SQ x 35.25"H w/ 2" SQ. x 4.5"H sleeve</p> <p>01722010-1 2" SQ. x 35.25"H with 2" SQ. sleeve</p>	<p>2" SQUARE NOTCHED</p>  <p>01622010-3 2" SQ. x 34.5"H w/ 24" notch</p>	<p>2" SQUARE W/ TAPERED FOOT</p>  <p>01622025-3 2" SQ. x 34.5"H</p> <p>01622025-1 2" SQ. x 35.25"H</p>	<p>2" SQUARE</p>  <p>01622010-1 2" SQ. x 35.25"H</p>
---	---	---	---

<p>3" SQUARE COLUMN</p>  <p>01623010-1 3" SQ. x 35.25"H</p>	<p>3" SQUARE COLUMN W/ TAPERED FOOT</p>  <p>01623025-1 3" SQ. x 35.25"H</p>	<p>3" SQUARE COLUMN W/ METAL SLEEVE</p>  <p>01723010-1 3" SQ. x 35.25"H</p>	<p>3" SQUARE COLUMN W/ METAL SLEEVE</p>  <p>01734510-1 3" SQ. x 35.25"H 4.5" Sleeve</p>
--	--	---	--

34.5" - 36.5" SQUARE ISLAND POSTS



POSTS & LEGS

AK:
Red Oak

AL:
Alder

CH:
Cherry

HM:
Hard Maple

HK:
Hickory

PT:
Paint Grade



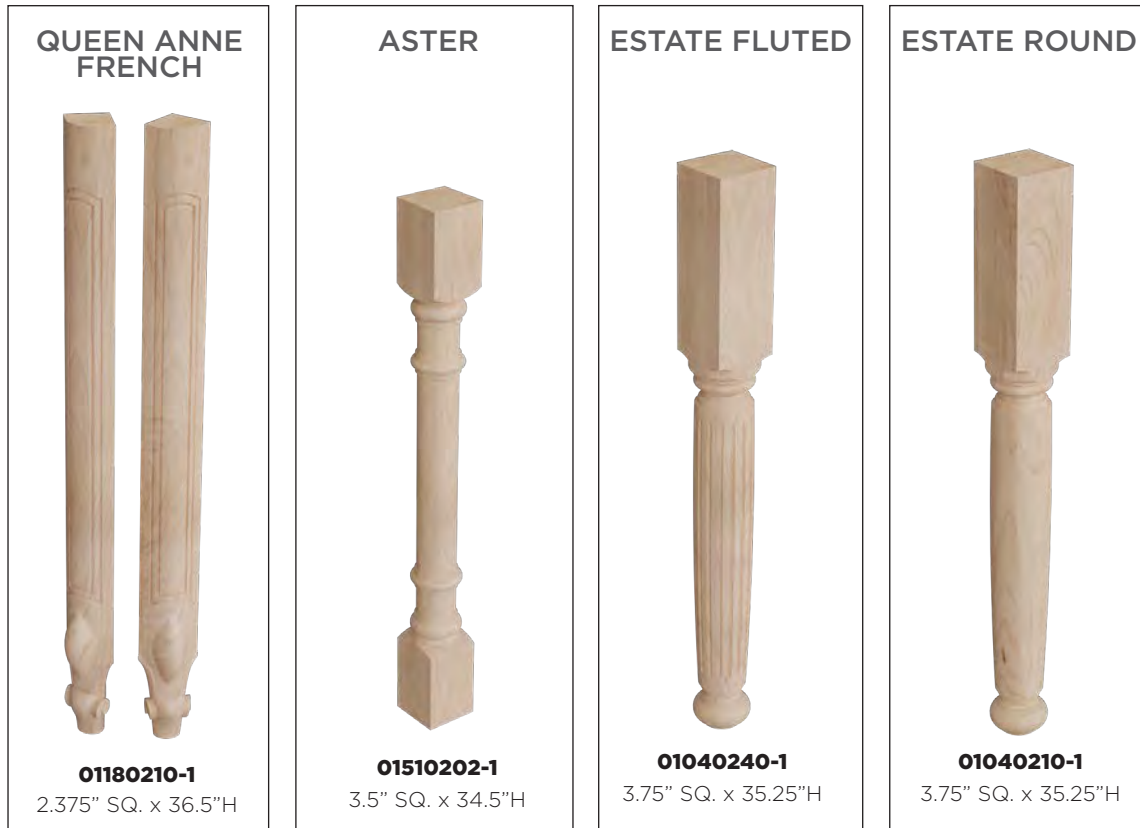

WK:
White Oak

WL:
Walnut

34.5" - 36.5" ISLAND POSTS



34.5" - 36.5" ISLAND POSTS

<p>ENGLISH COUNTRY</p>  <p>01000210-1 01210210-1 3.75" SQ. x 35.25"H 5" SQ. x 35.25"H</p>	<p>ENGLISH COUNTRY DOUBLE SQUARE</p>  <p>01030210-1 3.75" SQ. x 35.25"H</p>	<p>SUMTER DOUBLE SQUARE</p>  <p>01470210-1 5" SQ. x 35.25"H</p>	<p>COUNTRY FRENCH DOUBLE SQUARE</p>  <p>01410210-1 5" SQ. x 35.25"H</p>
--	---	--	---

<p>GAELIC</p>  <p>01590222-1 01590224-1 01590227-1 3.5" SQ. x 34.5"H 4.5" SQ. x 35.5"H 6" SQ. x 35.5"H</p>			<p>GAELIC - ROUTED</p>  <p>01590223-1 01590225-1 01590228-1 3.5" SQ. x 34.5"H 4.5" SQ. x 35.5"H 6" SQ. x 35.5"H</p>		
--	--	--	--	--	--

POSTS & LEGS

AK:
Red Oak

AL:
Alder

CH:
Cherry

HM:
Hard Maple

HK:
Hickory

PT:
Paint Grade

WK:
White Oak

WL:
Walnut

34.5" - 36.5" ISLAND POSTS

IONIC ACANTHUS



01520223-1
6" SQ. X 35.25"H

WRIGHT



01040270-1
3.5" SQ. x 35.25"H

WRIGHT W/
DETACHABLE FOOT



01040275-1
3.5" SQ. x 35.25"H

KENSINGTON



01110210-1
3" SQ. x 35.25"H

ESTATE SQUARE



01042760-1
2.75" SQ. x 35.25"H



01040260-1
3.75" SQ. x 35.25"H



01220260-1
5" SQ. x 35.25" H

NOUVEAU



01250210-1
3.5" SQ. x 35.25"H

BUNGALOW



01510228-1
3" SQ. x 34.5"H



01515028-1
5" SQ. x 34.5"H

34.5" - 36.5" ISLAND POSTS



34.5" - 36.5" ISLAND POSTS

<p>APEX</p>  <p>01570217-1 3.5" SQ. x 34.5"H</p>	<p>PALLADIAN</p>  <p>01580217-1 3.5" SQ. x 34.5"H</p>	<p>ROMAN CLASSIC</p>  <p>01082710-1 01080210-1 01230210-1 2.75" SQ. x 35.25"H 3.75" SQ. x 35.25"H 5" SQ. x 35.25"H</p>	<p>ROMAN CLASSIC WEAVED</p>  <p>01080270-1 3.75" SQ. x 35.25"H</p>
---	--	--	---

<p>ROMAN CLASSIC FLUTED</p>  <p>01082740-1 01080240-1 01230240-1 2.75" SQ. x 35.25"H 3.75" SQ. x 35.25"H 5" SQ. x 35.25"H</p>	<p>ROMAN CLASSIC ROPED</p>  <p>01082730-1 01080230-1 01230230-1 2.75" SQ. x 35.25"H 3.75" SQ. x 35.25"H 5" SQ. x 35.25"H</p>	<p>TULIP</p>  <p>01140210-1 3.5" SQ. x 34.5"H</p>
--	--	--

34.5" - 36.5" ISLAND POSTS

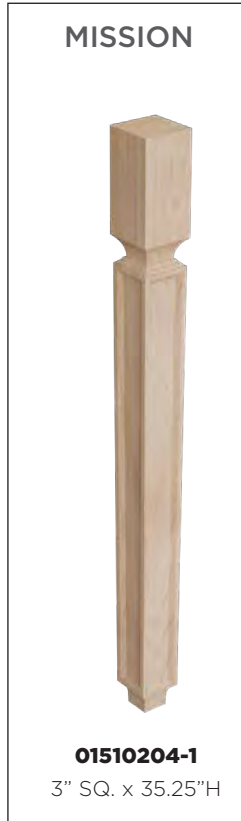

POSTS & LEGS

AK:
Red Oak

AL:
Alder

CH:
Cherry

HM:
Hard Maple

HK:
Hickory

PT:
Paint Grade

WK:
White Oak

WL:
Walnut

41"- 42.25" BAR POSTS

NOUVEAU



01250310-1
5.5" SQ. x 41"H

BUNGALOW



01510328-1
3" SQ. x 42.25"H

2" SQUARE



01632010-1
2" SQ. x 42.25"H

3" SQUARE



01633010-1
3" SQ. x 42.25"H



01733010-1
3" SQ. x 42.25"H
w/ 3" SQ. sleeve

4" SQUARE



01734010-1
4" SQ. x 42.25"H
w/ 4" SQ. sleeve



01634010-1
4" SQ. x 42.25"H

5" & 6" SQUARE



01735010-1
5" SQ. x 42.25"H w/
5" SQ. sleeve



01635010-1
5" SQ. x 42.25"H



01636010-1
6" SQ. x 42.25"H

40.5" - 42.25" BAR POSTS

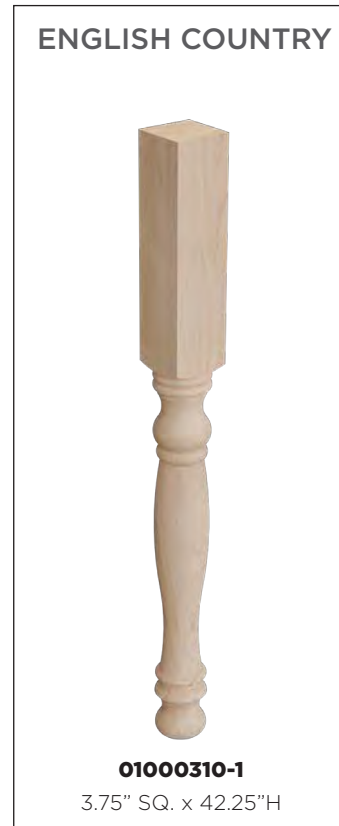

POSTS & LEGS

AK:
Red Oak

AL:
Alder

CH:
Cherry

HM:
Hard Maple

HK:
Hickory

PT:
Paint Grade

WK:
White Oak

WL:
Walnut



END PANELS & BASES

Image: Radiused Base without Toe Kick

X-PANELS

TRIMMABLE HARDWOOD X-PANEL

Features 7.5" Trimmable Bottom



01XPN3025LNG-1
25"W x 3"T
x 34.5"H



01XPN3036LNG-1
36"W x 3"T
x 34.5"H



01XPN1525LNG-1
25"W x 1.5"T
x 34.5"H



01XPN1536LNG-1
36"W x 1.5"T
x 34.5"H

HARDWOOD X-PANEL



01XPNL3025-1
25"W x 3"T
x 34.5"H



01XPNL3036-1
36"W x 3"T
x 34.5"H



01XPNL1525-1
25"W x 1.5"T
x 34.5"H



01XPNL1536-1
36"W x 1.5"T
x 34.5"H

END PANELS & BASES

AK:
Red Oak

AL:
Alder

CH:
Cherry

HM:
Hard Maple

WK:
White Oak

WL:
Walnut

X-PANELS

TRIMMABLE HARDWOOD X-PANEL WITH BACKERS

Features 7.5" Trimmable Bottom



01XPN3025LNG-4
25"W x 3"T
x 34.5"H



01XPN3036LNG-4
36"W x 3"T
x 34.5"H



01XPN1525LNG-4
25"W x 1.5"T
x 34.5"H



01XPN1536LNG-4
36"W x 1.5"T
x 34.5"H

HARDWOOD X-PANEL WITH BACKERS



01XPNL3025-4
25"W x 3"T
x 34.5"H



01XPNL3036-4
36"W x 3"T
x 34.5"H



01XPNL1525-4
25"W x 1.5"T
x 34.5"H



01XPNL1536-4
36"W x 1.5"T
x 34.5"H



Please note:
Backer and panel
ship unattached

STEEL BASES

STEEL X-BASES



01XBS3424WR1
24"W x 2.362"T x 34.5"H



01XBS3436WR1
36"W x 2.362"T x 34.5"H

PEDESTAL BASES

CHARLESTON PEDESTAL



01290180-1
12" Diam. x 29.5"H



01290280-1
12" Diam x 33.5"H

END PANELS & BASES

AK:
Red Oak

AL:
Alder

CH:
Cherry

HM:
Hard Maple

WK:
White Oak

WL:
Walnut

RADIUSED BASE



Image: Radiused Base with Toe Kick

NEW!

RADIUS BASE WITH TOE KICK

RADIUS BASE WITHOUT TOE KICK



01RADTBS2534-1

25"W x 9"D x 34.5"H
w/4.5" Toe Kick Base

01RADTBS3634-1

36"W x 9"D x 34.5"H
w/4.5" Toe Kick Base



01RADBS2534-1

25"W x 9"D x 34.5"H

01RADBS3634-1

36"W x 9"D x 34.5"H

KITCHEN ISLAND EXTENSION BASES

Expand both the function and style of your kitchen with our new Kitchen Island Extension Bases. Available in three versatile shapes, these extensions are designed to complement a variety of design styles. Each piece is built with solid hardwood ends for lasting strength and MDF sides for stability, ensuring durability. Easily customizable with your choice of veneer or beaded panels, these extensions allow you to create a seamless look that enhances cabinetry while adding practical workspace or seating.



BASE SHAPE KITS

Kits Include: (1) Base shape, (2) Hardwood Mounting Plates or End Plugs, *(2) pcs Tambour, and (1) Cutting Template.



END PANELS & BASES

HM:
Hard Maple

MDF:
Medium Density
Fiberboard

WK:
White Oak

WL:
Walnut

HARDWOOD ISLAND PANELS WITH REMOVABLE CENTERS

Our new hardwood island end panels are designed to bring both flexibility and craftsmanship to kitchen and furniture design. Each panel features a removable center section that allows for easier finishing and unlimited customization. The center panels can be replaced with a variety of materials—including beaded wood, leather, resin, or other decorative inserts—making it simple to tailor the look to match any style or design theme. Call for custom panel quotes.



Pictured: END PANEL 01EPS3036-1

NEW!

END PANEL: SHORT FRAME



01EPS3025-1
25"W x 3"T x 34.5"H
01EPS3036-1
36"W x 3"T x 34.5"H

END PANEL: TALL FRAME



01EPT1525-1
25"W x 1.5"T x 34.5"H
01EPT1536-1
36"W x 1.5"T x 34.5"H
01EPT3025-1
25"W x 3"T x 34.5"H
01EPT3036-1
36"W x 3"T x 34.5"H

END PANEL: ARCH



01EPAR1525-1
25"W x 1.5"T x 34.5"H

FURNITURE & BUN FEET



Image: Round Tapered Legs

SPECIALTY FEET

HAND CARVED CENTER PEDESTAL



01708310-1
16"W X 2.5"H

HAND CARVED CORNER PEDESTAL



01708010-1
8.25"W x 8.25"W x 4"H

HAND CARVED
LEFT & RIGHT PEDESTAL SET



SOLD AS A 2-PC SET
01708110-1
8.25"W x 4"H

HAMPTON LEFT



01703110-1
6"W x 4.5"H x 1.5"T

HAMPTON CORNER



01703010-1
4.5"H x 1.5"T x 6"L x 6"L

HAMPTON RIGHT



01703210-1
6" W x 4.5" H x 1.5" T

CARVED BUN FEET

BELLA SMOOTH



01707410-1
3.75" DIAM. x 8"H

BELLA FLUTED



01707440-1
3.75" DIAM. x 8"H

SCROLL



01709010-1
3.25"D. x 3.25"W x 4.5"H

ACANTHUS CORNER



01707710-1
3.375" SQ. x 4.5"H



FURNITURE & BUN FEET

AK:
Red Oak

AL:
Alder

CH:
Cherry

HM:
Hard Maple

HK:
Hickory

PT:
Paint Grade

WK:
White Oak

WL:
Walnut

SQUARE TURNED BUN FEET

NOUVEAU



01700457-1
4" SQ. x 4"H

01700459-1
3.25" SQ. x 4"H

METRO



01705710-1
4" SQ. x 4.5"H

TULIP SQUARE



01706065-1
3.5" SQ. x 4.625"H

SUMMIT



01705080-1
4" SQ. x 4.5"H

LILLE SQUARE



01750460-1
4" SQ. x 4"H

01704060-1
4" SQ. x 4.5"H

EMPIRE



01700146-1
3" SQ. x 4.5"H

KENSINGTON



01703510-1
3" SQ. x 4.5"H

LIAM



01700627-1
4.62" SQ. x 6"H

SQUARE COLUMN BASE



01705860-1
6" SQ. x 4.5"H

SHAKER



01705715-1
4.5" SQ. x 4.5"H

SQUARE & SQUARE TAPERED FURNITURE & BUN FEET

CRAFTSMAN CORNER



01705175-1
3.75"W x 3.75"W x 6"H

SQUARE TAPERED



01705610-1
1.875" SQ. x 6"H

SQUARE CRAFTSMAN



01705112-1
3" SQ. x 6"H

SQUARE COLUMN BASE



01705510-1
3.75" SQ. x 4"H

01705810-1
5" SQ. x 5"H

TAPERED



01705225-1
3.5" SQ. x 4.5"H

WRIGHT



01704075-1
3" SQ. x 4.5"H
(6.5" overall height)

STRATFORD



01705110-1
2.375" SQ. x 6"H

10" TALL SQUARE LEG W/ METAL SLEEVE



01731010-1
3" SQ. x 10"H

2" SQUARE LEG W/ TAPER



01700210-1
2" SQ. x 10"H

3" SQUARE LEG W/ TAPER



01700310-1
3" SQ. x 10"H

FURNITURE & BUN FEET

AK:
Red Oak

AL:
Alder

CH:
Cherry

HM:
Hard Maple

HK:
Hickory

PT:
Paint Grade

WK:
White Oak

WL:
Walnut

TOE KICK FEET

TULIP



01706060-1

4"W x 2.5"T x 4.625"H

PALLADIAN



01700018-1

4"W x 2.5"T x 4.5"H

APEX



01705155-1

2.5" SQ. x 4"H



01705150-1

2.75" SQ. x 4"H

TOE KICK FOOT W/ 4.5" METAL SLEEVE



01700245-1

01700245-6

2" SQ. x 4.5"H



01700345-1

01700345-6

3" SQ. x 4.5"H

-6: includes a pre-installed 5/16-18 hanger bolt protruding .75"

ROUND TURNED BUN FEET

CLASSIC



01705310-1

3.625" DIAM. x 4.5"H

CRAFTSMAN



01760410-1

3.625" DIAM. x 4"H



01704210-1

3.625" DIAM. x 4.5"H

TULIP



01706010-1

3.5" DIAM. x 4.625"H

COUNTRY FRENCH



01702510-1

3.625" DIAM. x 4"H



01700015-1

3.875" DIAM. x 4.5"H

MADISON



01704110-1

3" DIAM. x 6.125"H

AIDEN



01700327-1

3.625" DIAM. x 4.5"H

LILLE



01704010-1

4" DIAM. x 4.5"H

LILLE FLUTED



01704040-1

4" DIAM. x 4.5"H

OXFORD



01704910-1

4" DIAM. x 4.5"H

FURNITURE & BUN FEET

AK:
Red Oak

AL:
Alder

CH:
Cherry

HM:
Hard Maple

HK:
Hickory

PT:
Paint Grade

WK:
White Oak

WL:
Walnut

6" & 9" FURNITURE FEET

-6: Includes a pre-installed 5/16-18 hanger bolt protruding .75"

ROUND TAPERED LEGS W/ FERRULE

01240006-1
01240006-6
1.5" DIAM. x 6" H

01240009-1
01240009-6
1.87" DIAM. x 9" H

SQUARE TAPERED LEGS W/ FERRULES

01241006-1
01241006-6
1.5" SQ. x 6" H

01241009-1
01241009-6
1.87" SQ. x 9" H

TIPTOE W/ FERRULE

01242006-1
01242006-6
2.75" DIAM. x 6" H

01242009-1
01242009-6
3.625" DIAM. x 9" H

ROUND TAPERED FEET W/ BRASS SLIPPER CUP

01221006-6
2" DIAM. x 6" H

01221009-6
2.6875" DIAM. x 9" H

SQUARE TAPERED FEET W/ BRASS SLIPPER CUP

01222006-6
2.625" DIAM. x 6" H

CALLA FEET W/ BRASS SLIPPER CUP

01223006-6
2.5" DIAM. x 6" H

01223009-6
2.5" DIAM. x 9" H

PERLE

01245106-1
01245106-6
2.25" DIAM. x 6" H

01245109-1
01245109-6
2.75" DIAM. x 9" H

ROUND TAPERED

01243006-1
01243006-6
1.5" DIAM. x 6" H

01243009-1
01243009-6
1.87" DIAM. x 9" H

SQUARE TAPERED

01244006-1
01244006-6
1.5" SQ. x 6" H

01244009-1
01244009-6
1.87" SQ. x 9" H

FURNITURE & BUN FEET

CHROME

ANGLE ROUND



01700400CR1

2.813" PLATE x 5.375"D
x 4.875"H

5" SQUARE
CORNER



01700402CR1

4" SQ. x 5"H

ROUND CORNER



01700012CR1

4.134" PLATE x 5.906"D
x 6"H

STRAIGHT
ROUND



01700905CR1

3.5" DIAM. x 4"H

SOLID BRASS

RUTLAND



01700408-1

4.969"W X 7.189"H

DEVON



01700406-1

1.44"W X 5.906"H

ESSEX



01700412-1

2"W X 5.5"H
w/3"X3" plate

TYNE



01700410-1

2.106"W X 5.875"H
w/2" plate

BRISTOL



01700401WR1

1.17"W X 6.18"H
w/4x4 plate

4" APEX



01704017-1

3.75"W X 4"H

APEX VASA



01706018-1

4.724"W X 5.906"H

ALUMINUM SLEEVES AND FERRULES

SQUARE METAL FERRULES

Pictured in Brushed Aluminum

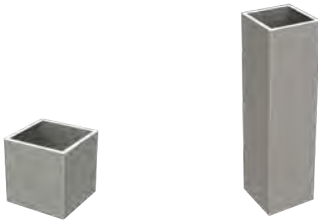

01FRS1010-1

1" SQ. OUTER DIM.
x .125"T x 1"H

01FRS1254-1

1.25" SQ. OUTER DIM.
x .125"T x 4"H

ROUND METAL FERRULES

Pictured in Brushed Aluminum



01FRC1010-1

.913" OUTER DIAM.
x .125"T x 1"H

01FRC1040-1

.913" OUTER DIAM.
x .125"T x 4"H

TOE KICK METAL SLEEVES

Pictured in Chrome



01SLV245-1

2" SQ. OUTER DIM.
x .125"T x 4.5"H

01SLV345-1

3" SQ. OUTER DIM.
x .125"T x 4.5"H

ALUMINUM SLEEVES



01SLV2-1

2" SQ. OUTER DIM.
x .125"T x 2"H



01SLV3-1

3" SQ. OUTER DIM.
x .125"T x 3"H



01SLV4-1

4" SQ. OUTER DIM. x
.125"T x 4"H



01SLV5-1

5" SQ. OUTER DIM.
x .125"T x 5"H
BA & WR Only

BA:
Brushed
Aluminum

CR:
Chrome

GL:
Soft Gold

PB:
Polished Brass

SB:
Satin Brass

ST:
Satin Stainless

WB:
Warm Bronze

WR:
Flat Black

BRASS SLIPPER CUPS

SOLID BRASS SLIPPER CUPS

Pictured in Chrome



01SLPR106-1

1.59" SQ. X 1.89"H



01SLPR105-1

1.26" DIAM. X 2.165"H



01SLPR104-1

1.154" DIAM. X 1.87"H

FURNITURE & BUN FEET

AB:
Antique Brass

CR:
Chrome

PB:
Polished Brass

SB:
Satin Brass

WR:
Flat Black



BRACKETS & CORBELS

Image: Lexington Bracket & Gallery Rail

BRACKETS

NEW! BRASS BRACKETS

Knurled & Plain Styles Available

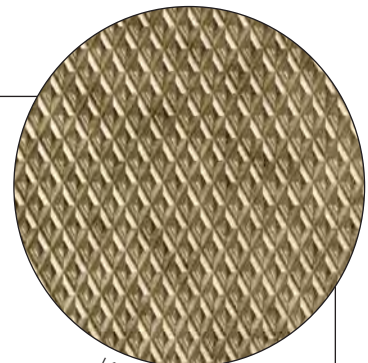

Knurled Texture



01NARCHKNLD75-1

Knurled
7.5"D X 10"H X 1"W



01WARCHKNLD75-1

Knurled
7.5"D X 10"H X 1"W



01WARCHPLN75-1

7.5"D X 10"H X 1"W



01NARCHPLN75-1

7.5"D X 10"H X 1"W

BAUHAUS BRACKET

Check Website for Arch Finishes



01600016-1

2.125"W x 9"D x 12"L

01600006-1

2.125"W x 7"D x 9"L

MID-CENTURY TRIANGLE BRACKET

Check Website For Finishes



01651270-1

.75"W X 12.625"D X 6.875"H

BRACKETS

LEXINGTON BAR BRACKET



01605006-1
2.5"W x 10"D x 5"L



01605007-1
1.5"W x 10"D x 5"L



01605008-1
2.5"W x 10"D x 7.5"L



01605009-1
1.5"W x 10"D x 7.5"L

CONTOUR BRACKET



01600300-1
2.5" W x 9" D x 9" L

ARTS & CRAFTS BRACKET



01607012-1
5" W x 7.5" D x 11.5" L

BRACKETS & CORBELS

AK:
Red Oak

AL:
Alder

CH:
Cherry

HM:
Hard Maple

HK:
Hickory

PT:
Paint Grade

WK:
White Oak

WL:
Walnut

CORBELS

NEW! CONTEMPORARY CORBEL WITH METAL* / LEATHER* ACCENTS



01600001-1
3"W x 6"D x 12"L



01600002-1
4.5"W x 18"D x 12"L



01600003-1
4.5"W x 8"D x 34.5"L

PORTRAIT CORBEL



01600009-1
3" W x 8" D x 12" L

TRIAD CORBEL-NARROW



01607009-1
2.875" W x 9" D x 12" L



01607008-1
2.875" W x 7" D x 9" L

TRIAD CORBEL



01607006-1
7.5" W x 6" D x 8.375" L



01607007-1
3.75" W x 4" D x 5.5" L

CORBELS

PLAIN NOUVEAU CORBEL



01601400-1

5.5" W x 9" D x 13" L



01601300-1

5.5" W x 2.75" D x 13" L



01601100-1

3.5" W x 3.875" D x 6.831" L

SIMPLICITY CORBEL



01607004-1

5.5" W x 6.875" D x 7.5" L



01607001-1

4.5" W x 5.75" D x 5" L



01607005-1

3.5" W x 4.125" D x 4.5" L

BRACKETS & CORBELS

AK:
Red Oak

AL:
Alder

CH:
Cherry

HM:
Hard Maple

HK:
Hickory

PT:
Paint Grade

WK:
White Oak

WL:
Walnut

CORBELS

APEX CORBEL



01607117-1

3"W X 3.875"D X 7"L

01607217-1

3.875" W x 5" D x 8.75" L

01607317-1

6" W x 8" D x 14" L

REVIVAL CORBEL



01604510-1

3.75" W x 9" D x 14" L

01604505-1

3.75" W x 9" D x 9" L

SHAKER CORBEL



01606002-1

3.875" W x 3.5" D x 6.75" L

01606001-1

5.25" W x 6.75" D x 13.25" L

01606003-1

6.625" W x 7.5" D x 16" L

CORBELS

CRAFTSMAN CORBEL



01608009-1	01608007-1	01608010-1	01608008-1
2.75" W x 6" D x 10" L	1.5" W x 8" D x 12" L	3.5" W x 8" D x 12" L	3.5" W x 8" D x 12" L

PETITE CRAFTSMAN CORBEL



01608001-1
1.25"W X 1.5"D X 3"L

MISSION CORBEL



01601205-1	01601204-1	01601203-1
5.75" W x 3.875" D x 9" L	3.5" W x 3.5" D x 13" L	3.5" W x 9" D x 13" L

BRACKETS & CORBELS

AK:
Red Oak

AL:
Alder

CH:
Cherry

HM:
Hard Maple

HK:
Hickory

PT:
Paint Grade

WK:
White Oak

WL:
Walnut

CORBELS

ARTS & CRAFTS CORBEL



01607010-1

4.5" W x 7.5" D x 14" L



01607011-1

3.75" W x 5.813" D x 9" L

PINNACLE CORBEL



01607316-1

9" W x 7.25" D x 12" L



01607216-1

5.5" W x 5" D x 8" L

HAND CARVED GRAPE CORBEL



01901005-1

5.5" W x 7" D x 15" L



01901003-1

3.5" W x 8" D x 13" L

MADLINE CORBEL



01607315-1

4" W x 9.5" D x 14" L



01607215-1

2.5" W x 6.125" D x 8" L

CORBELS



BRACKETS & CORBELS

AK:
Red Oak

AL:
Alder

CH:
Cherry

HM:
Hard Maple

HK:
Hickory

PT:
Paint Grade

WK:
White Oak

WL:
Walnut

CORBELS

CORINTHIAN CORBEL



01605001-1

4.75" W x 5.5" D x 9.625" L



01605000-1

3.875" W x 3" D x 8" L



01605005-1

3.5" W x 7" D x 14" L

CORINTHIAN CORBEL



01904991-1

3.75" W x 8.5" D x 13" L



01904990-1

2.625" W x 2.5" D x 4.5" L



01901004-1

5.25" W x 4.5" D x 12.5" L



01904993-1

3.75" W x 8.5" D x 13" L

CORBELS

CELTIC CORBEL



01601427-1

5.5" W x 7.125" D x 14" L

01600927-1

4.75" W x 5.75" D x 9.5" L

01600627-1

3.5" W x 3.875" D x 6.625" L

PALLADIAN CORBEL



01600318-1

3" W x 3.875" D x 7" L



Image: Mid-Century Triangle Bracket w/ Flat Shelves

BRACKETS & CORBELS

AK:
Red Oak

AL:
Alder

CH:
Cherry

HM:
Hard Maple

HK:
Hickory

PT:
Paint Grade

WK:
White Oak

WL:
Walnut



CREATE-A-COLUMN™ HALF ROUND MOULDINGS & RADIUSED CORNER MOULDINGS

Image: Plain Half Round Moulding - Series 150

NEW! RADIUSED CORNER MOULDINGS

Add elegance and dimension to your cabinetry and furniture with our MDF Radiused Corner Mouldings. Featuring softly curved lines inspired by Art Deco design, these mouldings bring a refined, detail to any project. Crafted from high-quality MDF, they are supplied unfinished, ready to be painted or veneered.



Radiused Corner Without Toe Kick

Radiused Corner With 3" Toe Kick

2" RADIUS



01RADCRN297-1
2.366" x 2.366" x 97"H

3" RADIUS



01RADCRN397-1
3.394" x 3.394" x 97"H

6" RADIUS



01RADCRN697-1
3.394" x 6.394" x 97"H

*Available in MDF only. Hardwood coming soon.

CREATE-A-COLUMN™

AL:
Alder

AK:
Red Oak

CH:
Cherry

HM:
Hard Maple

MDF:
Medium Density
Fiberboard

QS:
Quarter Sawn
White Oak

WK:
White Oak

CREATE-A-COLUMN™ & HALF ROUND MOULDINGS

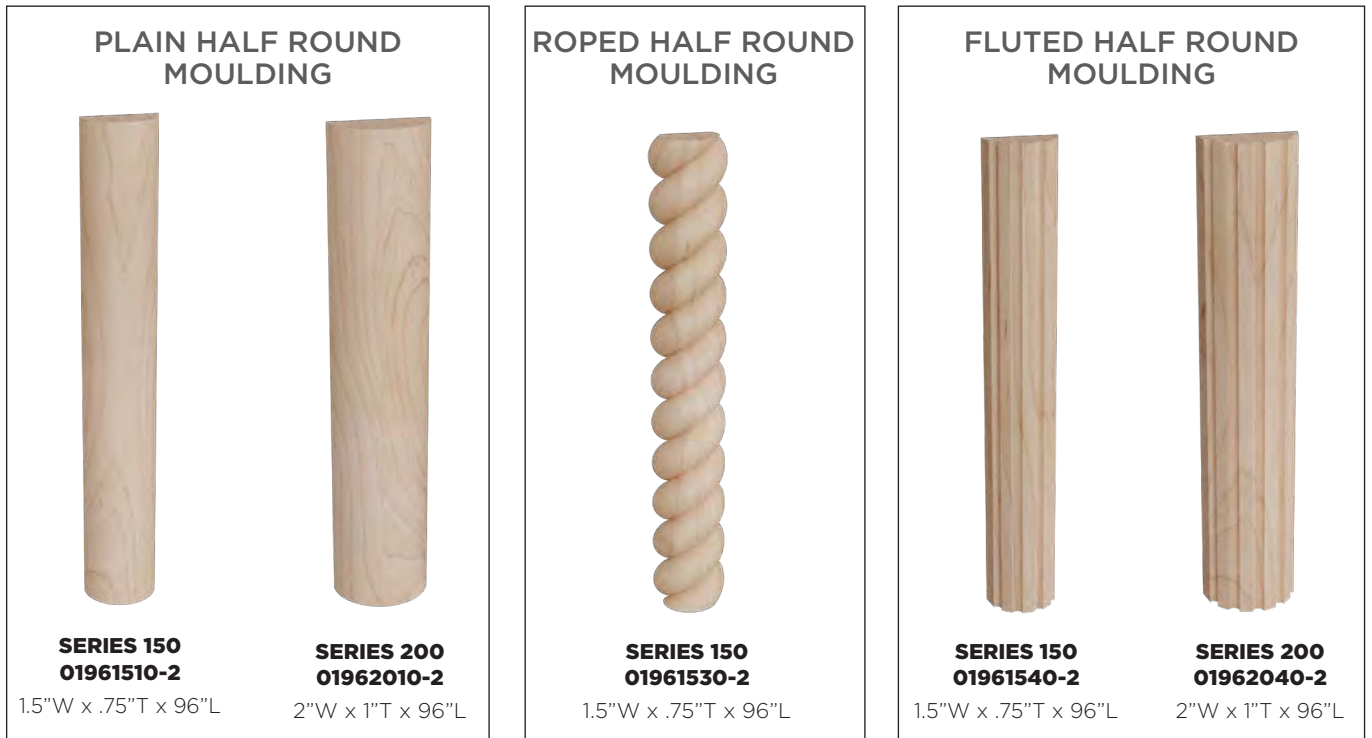

Series 150 are 1.5" Half Round Mouldings to fit spaces 2.5" or wider.
Series 200 are 2" Half Round Mouldings to fit spaces 3" or wider.



CREATE-A-COLUMN™ & HALF ROUND MOULDINGS

150 COMBO SPINDLE
For use with 1.5" half round



SERIES 150
01391510-2
2"W x .906"D x 9.438"L

CENTER SPINDLES



For use with 1.5" half round

SERIES 150
01311510-2
2.125"W x 1"D x 3"L

For use with 2" half round

SERIES 200
01312010-2
2.875"W x 1.3"D x 3.5"L

END BLOCKS



For use with 1.5" spindle

SERIES 150
01331510-2
2.5"W x 1.19"D x 5.75"L

For use with 2" spindle

SERIES 200
01332010-2
3"W x 1.4"D x 5.75"L

END SPINDLES



For use with 1.5" half round

SERIES 150
01321510-2
2.5"W x 1"D x 3"L

For use with 2" half round

SERIES 200
01322010-2
3"W x 1.5"D x 3.5"L



DECORATIVE MOULDINGS & PILASTERS

Image: Hardwood Shiplap Decorative Moulding

DECORATIVE MOULDINGS

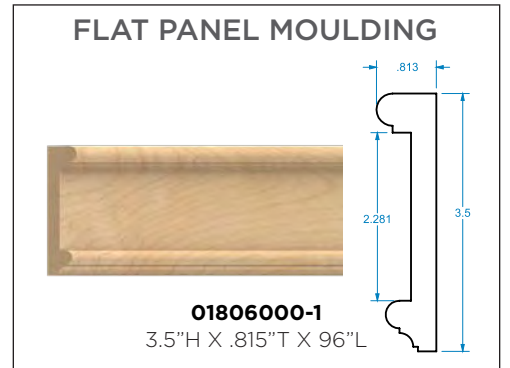
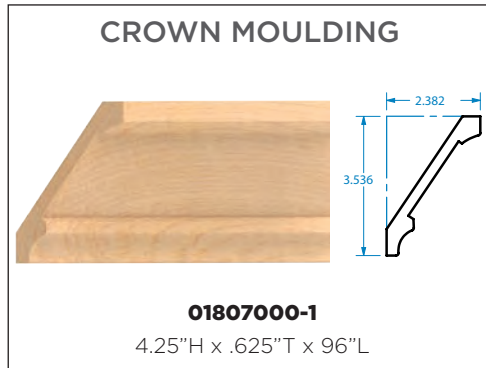
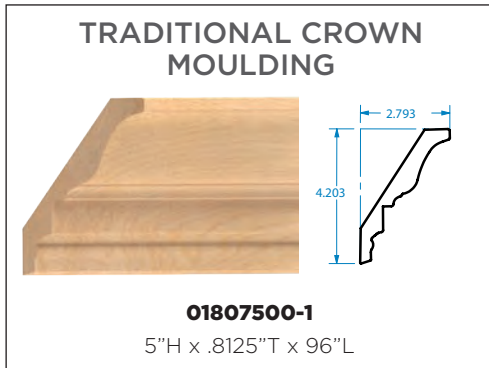
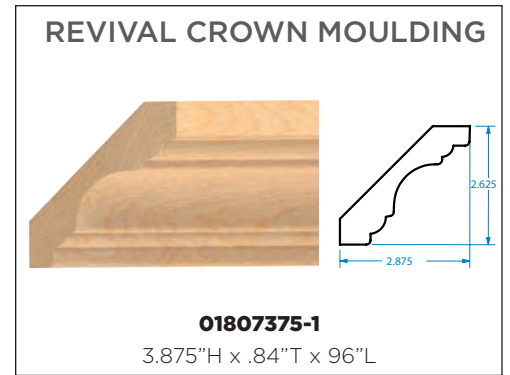

LIGHT RAIL MOULDING

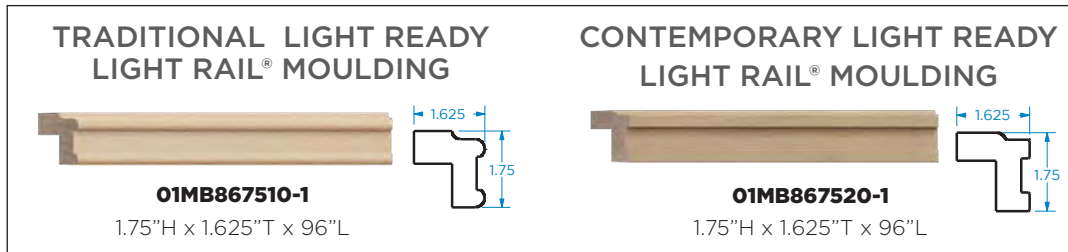

PILASTERS

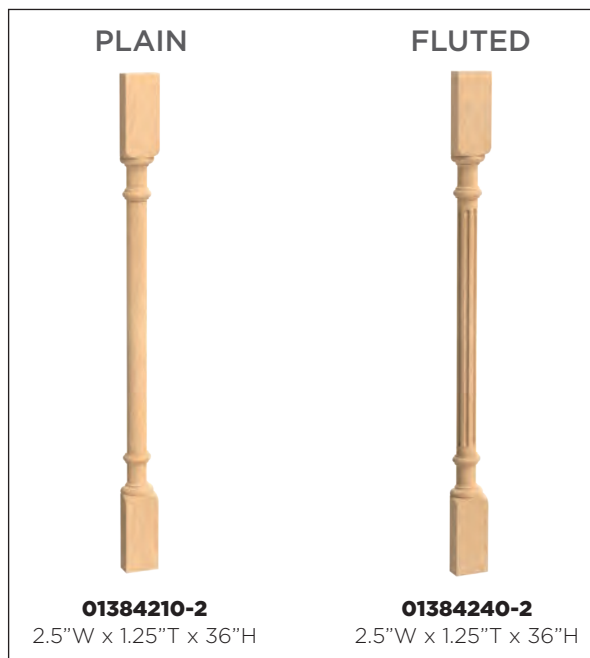

MOULDINGS

AK:
Red Oak

AL:
Alder

CH:
Cherry

HM:
Hard Maple

SHELVING

Image: Contemporary Floating Shelving



FLOATING SHELVING

Our floating shelves include hidden shelf supports. Hidden shelf supports can be purchased separately for use in your custom projects.

CONTEMPORARY FLOATING CORNER SHELF W/ HIDDEN STEEL SUPPORT



01MFL102424-1

10" D x 2.5" T x 24" Each Way

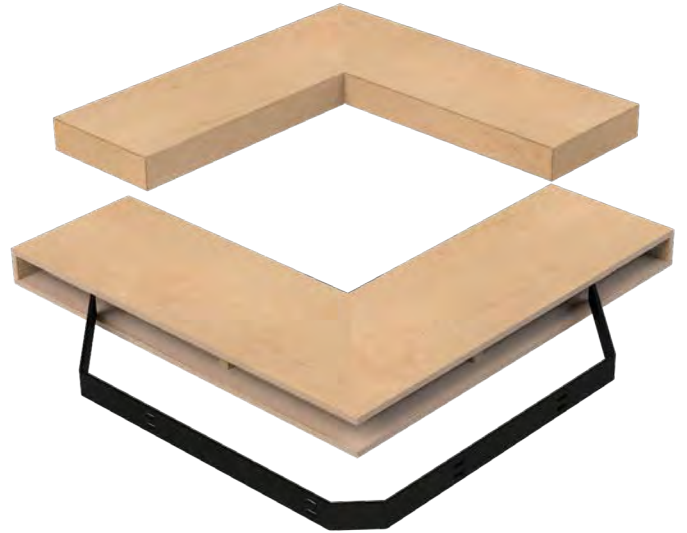

01MFL103030-1

10" D x 2.5" T x 30" Each Way

CONTEMPORARY FLAT CORNER SHELF



01MSH122424-1

12" D x .75" T x 24" Each Way



01MSH123030-1

12" D x .75" T x 30" Each Way

CONTEMPORARY FLOATING LINEAR SHELF W/ HIDDEN STEEL SUPPORT



01MFL102410-1

10" D x 2.5" T x 24" L



01MFL103610-1

10" D x 2.5" T x 36" L

Custom sizes available!

SHELVING

AK:
Red Oak

AL:
Alder

CH:
Cherry

HM:
Hard Maple

HK:
Hickory

PT:
Paint Grade

WK:
White Oak

WL:
Walnut

BRACKETS, STRAPS, CHANNEL SHELVING



SLIMLINE CHANNEL SHELF

- 01CHSHLF0424-1**
2.75" H x 24" W x 5.125" D
- 01CHSHLF0436-1**
2.75" H x 36" W x 5.125" D
- 01CHSHLF0448-1**
2.75" H x 48" W x 5.125" D
- 01CHSHLF0460-1**
2.75" H x 60" W x 5.125" D

Includes leveler & walldog screws.

SLIMLINE CHANNEL SHELF - ALUMINUM



- 01CHSHLF0424-1**
2.5" H x 24" W x 4.125" D
- 01CHSHLF0436-1**
2.5" H x 36" W x 4.125" D
- 01CHSHLF0448-1**
2.5" H x 48" W x 4.125" D

DEEP SLIMLINE CHANNEL SHELF - ALUMINUM



- 01CHSHLF0624-1**
2.5" H x 24" W x 6.125" D
- 01CHSHLF0636-1**
2.5" H x 36" W x 6.125" D
- 01CHSHLF0648-1**
2.5" H x 48" W x 6.125" D

Includes leveler & walldog screws.

**TEXTURED FLOATING SHELF
W/ HIDDEN STEEL SUPPORT**



- 01FL102410-1**
10" D x 2.5" T x 24" W
- 01FL103610-1**
10" D x 2.5" T x 36" W

**CORNER FLOATING SHELF -
HAND SCRAPPED**



- 01FL103030-1**
10" D x 2.5" T x 30" W

FLOATING SHELF & SUPPORT BRACKETS

HIDDEN CORNER SHELF SUPPORT



01981515WR1
21.718" W Each Way x 1.65" H
For use with 24" x 24" corner shelf.

01982222WR1
28.75" W Each Way x 1.75" H
For use with 30" x 30" corner shelf.

9" HIDDEN SHELF SUPPORT



01980109WR1
9.75" W x 8" D x 1.75" H
For use with any 10"D X 2"T floating shelf.

16" HIDDEN SHELF SUPPORT



01980116WR1
16" W x 8" D x 1.75" H
For use with any floating shelf.

22.5" HIDDEN SHELF SUPPORT



01981022WR1
22.25" W x 8" D x 1.75" H
For use with any floating shelf.



OUTLETS & VENTS

Image: Linear Style Toe Kick Vent

OUTLET COVERS

SINGLE OUTLET	DOUBLE OUTLET
	
01450002-1 3.5"W x .375"T x 5.75"H	01451002-1 5.5"W x .375"T x 5.75"H

SINGLE ROCKER	DOUBLE ROCKER	TRIPLE ROCKER	QUAD ROCKER
			
01450003-1 3.5"W x .375"T x 5.75"H	01451003-1 5.5"W x .375"T x 5.75"H	01453003-1 7.313"W x .375"T x 5.75"H	01454003-1 9.125"W x .375"T x 5.75"H

SINGLE SWITCH	DOUBLE SWITCH	TRIPLE SWITCH	QUAD SWITCH
			
01450001-1 3.5"W x .375"T x 5.75"H	01451001-1 5.5"W x .375"T x 5.75"H	01453001-1 7.313"W x .375"T x 5.75"H	01454001-1 9.125"W x .375"T x 5.75"H

FINISHING TOUCHES

AK: Red Oak

AL: Alder

CH: Cherry

HM: Hard Maple

WL: Walnut

WK: White Oak

OUTLET COVERS

SWITCH COMBO 1



01450012-1

5.5"W x .375"T x 5.75"H

SWITCH COMBO 2



01451012-1

7.313"W x .375"T x 5.75"H

SWITCH COMBO 3



01450013-1

5.5"W x .375"T x 5.75"H

SWITCH COMBO 4



01451013-1

7.313"W x .375"T x 5.75"H

SINGLE BLANK
SWITCH PLATE COVER



01452001-1

3.5"W x .375"T x 5.75"H

DOUBLE BLANK
SWITCH PLATE COVER



01452002-1

5.5"W x .375"T x 5.75"H

ELECTRICAL BOX ROUTING

Let your kitchen island design speak for itself with an integrated electrical outlet.

We offer Electrical Box Routing and Electrical Boring to most columns greater than 3"W. Electrical Box Routing allows you to install electrical components directly into the column. For additional electrical wiring, we can bore a ½" hole through the entire length of the column.

AVAILABLE FOR MOST COLUMNS.



TOE KICK VENT

GRATE STYLE TOE KICK VENT

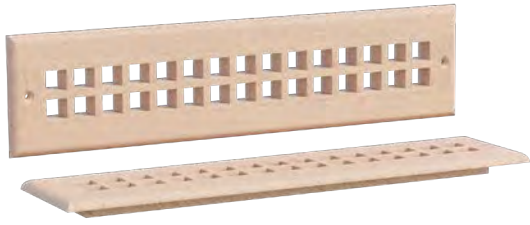

01992114-1
15.75"W x .75"T x 3.75"H



01992110-1
11.75"W x .75"T x 3.75"H



01992124-1
25.75"W x .75"T x 3.75"H



01992112-1
13.75"W x .75"T x 3.75"H

LINEAR STYLE TOE KICK VENT

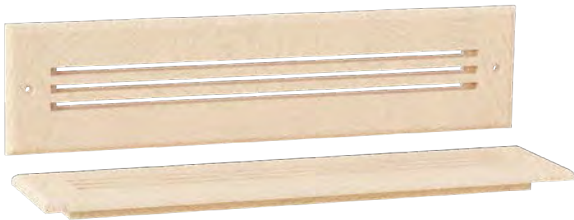

01992214-1
15.75"W x .75"T x 3.75"H



01992224-1
25.75"W x .75"T x 3.75"H



01992210-1
11.75"W x .75"T x 3.75"H



01992212-1
13.75"W x .75"T x 3.75"H

FINISHING TOUCHES

AK: Red Oak

AL: Alder

CH: Cherry

HM: Hard Maple

WL: Walnut

WK: White Oak

TOE KICK VENT

SELF RIMMING TOE KICK VENT



01992010-1
11.75"W x .75"T x 3.75"H



01992012-1
13.75"W x .75"T x 3.75"H



01992014-1
15.75"W x .75"T x 3.75"H



01992024-1
25.75"W x .75"T x 3.75"H

SELF RIMMING FLOOR VENT



01994014-1
15.75"W x .75"T x 5.75"H



01994010-1
11.75"W x .75"T x 5.75"H



01994012-1
13.75"W x .75"T x 5.75"H



CUSTOM PANEL INSERTS

Image: Custom Decorative Hardwood Panel

NEW! CUSTOM DECORATIVE PANELS

CHOOSE YOUR MATERIAL. CHOOSE YOUR STYLE. CHOOSE YOUR PLACEMENT.

Bring your designs to life with customizable panels crafted to fit your exact vision. Whether you're designing cabinetry, furniture, or architectural accents, our panels offer limitless creative options.



Material Options (2 Panel Minimum)

- **1/8" Brass Sheets:** Luxe metallic finish for a bold, modern look.
- **1/4" MDF:** Smooth and versatile, ready to paint or finish.
- **1/4" MDF with Hardwood Veneer:** Adds natural beauty and warmth.

Customization Choices

- **Style:** Select from a variety of decorative patterns.
- **Pattern Count:** Choose how many repeats per panel.
- **Placement:** Position your design at the top, center, or bottom of the panel.

Crafting Methods

- **CNC Routed:** Clean precision with a 1/16" minimum radius.
- **Laser Cut:** Tighter, more intricate designs with darkened interior edges that create a subtle shadow effect.

Why Choose Our Panels?

- Fully customizable for your project needs.
- Available in multiple premium materials.
- Options for clean precision or artistic detailing.
- Designed for cabinetry, furniture, and architectural features.

NEW! CUSTOM METAL CABINET MULLIONS

Our Custom Mullion Program offers designers and architects unparalleled versatility for elegant custom designs. Using CNC and laser-cutting technology, each panel features customizable patterns for optimal ventilation, ideal for cabinetry, closets, mudrooms, and architectural wall accents.

SIMPLE



Elevate Your Cabinetry with Style and Function

Our **custom metal mullions** bring sophistication and precision to cabinetry design. Perfect for high-end projects, these mullions combine elegance, functionality, and versatility.

Material & Finish Options

- **Stainless Steel:** Sleek, modern, and durable
- **Brass:** Warm, luxurious appeal
- **Finishes:** Plain, powder-coated, or clear-coated
- **Design Flexibility:** Ideal for intricate patterns and high-end design aesthetics
- Perfect for cabinetry requiring ventilation
- Delicate designs can be sandwiched between glass for a refined, custom look

Why Choose Our Metal Mullions?

- **Durable materials** suitable for long-lasting use
- Available in **multiple finishes** to match your design vision
- Perfect for creating **architectural detail** and **visual interest** in cabinetry
- Combines function with decorative appeal

STANDARD



COMPLEX



CUSTOM PANELS



Custom Laser-Cut Metal Mullions



GALLERY RAIL

Image: Double Contemporary Gallery Rail in Chrome

GALLERY RAIL

Install Gallery Rail components to the tops of cabinets, furniture, shelving, spice racks, and more to create a curated look. We recommend spacing between posts across the front to be 10" - 12" apart. Manufactured from the finest quality cast brass, Gallery Rail components will not tarnish, rust, peel, or chip. Gallery Rail Sample Kits are available.

BRASS TRADITIONAL

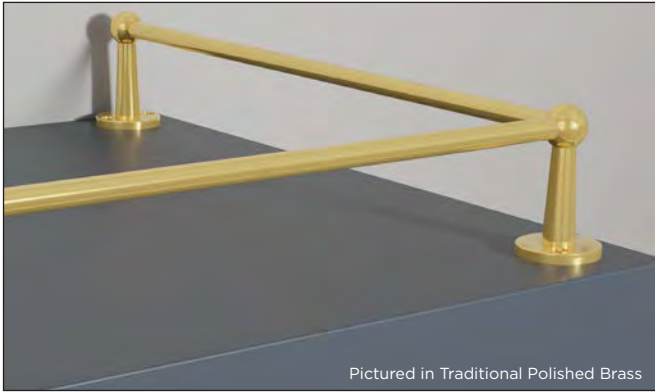

Pictured in Traditional Polished Brass

POLISHED BRASS

Corner Post: 01HC9002PB1
 .906" DIAM. x 1.575"H
Center Post: 01HC9001PB1
 .906" DIAM. x 1.575"H
End Post: 01HC9003PB1
 .906" DIAM. x 1.575"H
Rail: 01HC900436PB1
 6 mm DIAM. x 36"L



CHROME

Corner Post: 01HC9002CR1
 .906" DIAM. x 1.575"H
Center Post: 01HC9001CR1
 .906" DIAM. x 1.575"H
End Post: 01HC9003CR1
 .906" DIAM. x 1.575"H
Rail: 01HC900436CR1
 6 mm DIAM. x 36"L



FLAT BLACK

Corner Post: 01HC9002WR1
 .906" DIAM. x 1.575"H
Center Post: 01HC9001WR1
 .906" DIAM. x 1.575"H
End Post: 01HC9003WR1
 .906" DIAM. x 1.575"H
Rail: 01HC900436WR1
 6 mm DIAM. x 36"L



SATIN BRASS

Corner Post: 01HC9002SB1
 .906" DIAM. x 1.575"H
Center Post: 01HC9001SB1
 .906" DIAM. x 1.575"H
End Post: 01HC9003SB1
 .906" DIAM. x 1.575"H
Rail: 01HC900436SB1
 6 mm DIAM. x 36"L



Contemporary
Gallery Rail

BRASS GALLERY RAIL

SINGLE CONTEMPORARY



Pictured in Stainless Steel



STAINLESS STEEL

End Post: 01HC9014SS1
 .906" DIAM. x 1.575" H
Center Post: 01HC9015SS1
 .906" DIAM. x 1.575" H
Corner Adapter: 01HC9016SS1
 1.102" DIAM. X 1.654"H
Rail: 01HC900436SS1, 6 mm Diam. x 36"L



DOUBLE CONTEMPORARY



Pictured in Flat Black



STAINLESS STEEL

End Post: 01HC9024SS1
 1.063" DIAM. x 1.693" H
Center Post: 01HC9025SS1
 .906" DIAM. x 1.575" H
Corner Adapter: 01HC9026SS1
 1.102" DIAM. X 1.654"H
Rail: 01HC900436SS1, 6 mm Diam. x 36"L



FLAT BLACK

End Post: 01HC9014WR1
 .906" DIAM. x 1.575" H
Center Post: 01HC9015WR1
 .906" DIAM. x 1.575" H
Corner Adapter: 01HC9016WR1
 1.102" DIAM. X 1.654"H
Rail: 01HC900436WR1, 6 mm Diam. x 36"L



FLAT BLACK

End Post: 01HC9024WR1
 1.063" DIAM. x 1.693" H
Center Post: 01HC9025WR1
 .906" DIAM. x 1.575" H
Corner Adapter: 01HC9026WR1
 1.102" DIAM. X 1.654"H
Rail: 01HC900436WR1, 6 mm Diam. x 36"L



SATIN BRASS

End Post: 01HC9014SB1
 .906" DIAM. x 1.575" H
Center Post: 01HC9015SB1
 .906" DIAM. x 1.575" H
Corner Adapter: 01HC9016SB1
 1.102" DIAM. X 1.654"H
Rail: 01HC900436SB1, 6 mm Diam. x 36"L



SATIN BRASS

End Post: 01HC9024SB1
 1.063" DIAM. x 1.693" H
Center Post: 01HC9025SB1
 .906" DIAM. x 1.575" H
Corner Adapter: 01HC9026SB1
 1.102" DIAM. X 1.654"H
Rail: 01HC900436SB1, 6 mm Diam. x 36"L



POLISHED BRASS

End Post: 01HC9014PB1
 .906" DIAM. x 1.575" H
Center Post: 01HC9015PB1
 .906" DIAM. x 1.575" H
Corner Adapter: 01HC9016PB1
 1.102" DIAM. X 1.654"H
Rail: 01HC900436PB1, 6 mm Diam. x 36"L



POLISHED BRASS

End Post: 01HC9024PB1
 1.063" DIAM. x 1.693" H
Center Post: 01HC9025PB1
 .906" DIAM. x 1.575" H
Corner Adapter: 01HC9026PB1
 1.102" DIAM. X 1.654"H
Rail: 01HC900436PB1, 6 mm Diam. x 36"L



CHROME

End Post: 01HC9014CR1
 .906" DIAM. x 1.575" H
Center Post: 01HC9015CR1
 .906" DIAM. x 1.575" H
Corner Adapter: 01HC9016CR1
 1.102" DIAM. X 1.654"H
Rail: 01HC900436CR1, 6 mm Diam. x 36"L



CHROME

End Post: 01HC9024CR1
 1.063" DIAM. x 1.693" H
Center Post: 01HC9025CR1
 .906" DIAM. x 1.575" H
Corner Adapter: 01HC9026CR1
 1.102" DIAM. X 1.654"H
Rail: 01HC900436CR1, 6 mm Diam. x 36"L



GALLERY RAIL

CR
 Chrome

PB:
 Polished Brass

SB:
 Satin Brass

SS:
 Stainless Steel

WR:
 Flat Black



DECORATIVE BRASS HARDWARE

Image: Knurled Brass Footrail

NEW! DESIGNER CANTILEVER BISTRO SHELVING

Available in Knurled, Reeded and Plain styles. Comes in Lacquered Polished Brass and Satin Brass finishes.

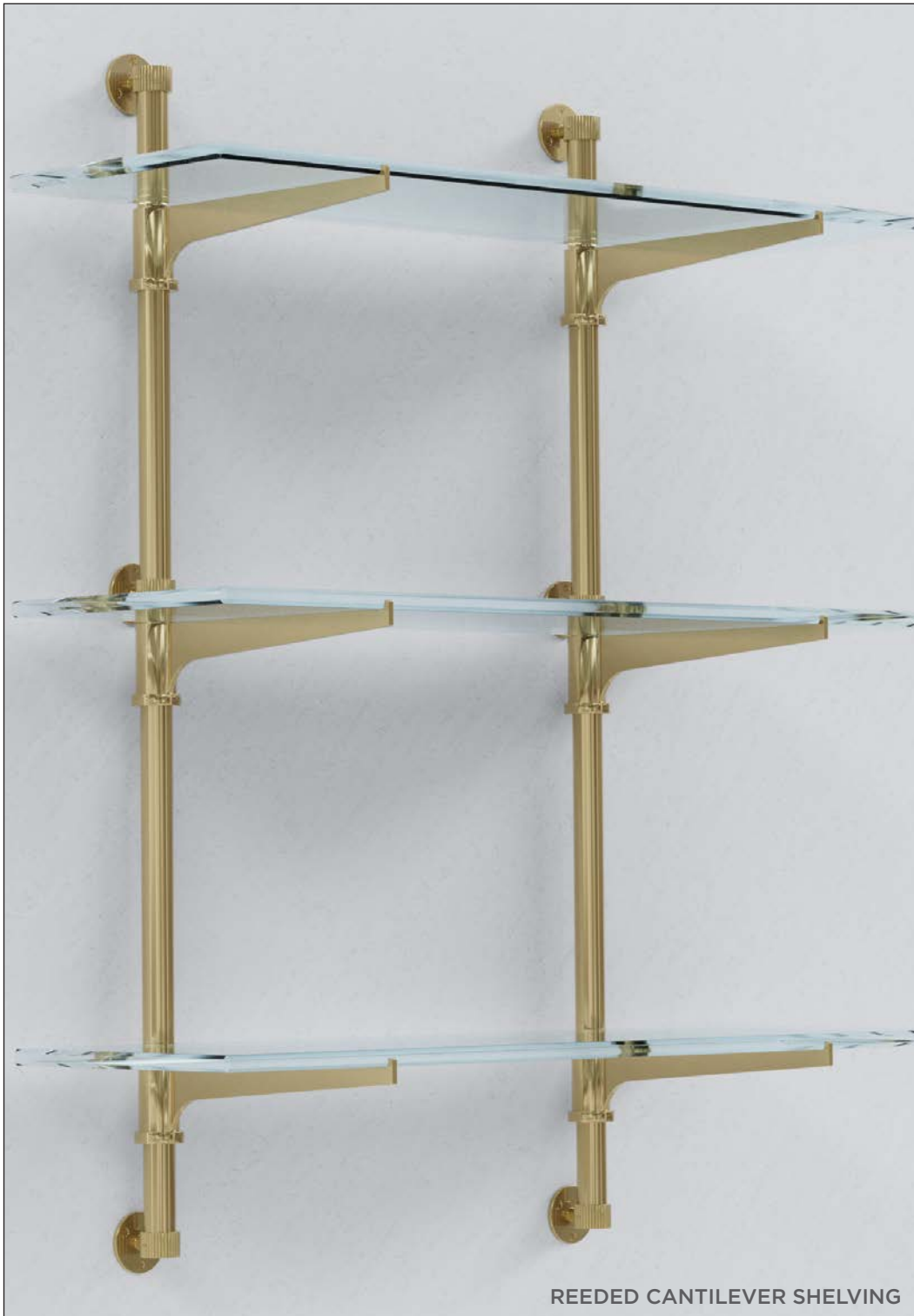

REEDED CANTILEVER SHELVING

DESIGNED FOR USE WITH 10" DEEP SHELVES ONLY
GLASS SHELVES NOT INCLUDED



KNURLED

3 SHELF
01KCANT1036-1
36" high, 13" deep

4 SHELF
01KCANT1048-1
48" high, 13" deep



REEDED

3 SHELF
01RCANT1036-1
36" high, 13" deep

4 SHELF
01RCANT1048-1
48" high, 13" deep



PLAIN

3 SHELF
01CANT1036-1
36" high, 13" deep

4 SHELF
01CANT1048-1
48" high, 13" deep

Custom finishes & sizes available.

BRASS HARDWARE

PB:
Polished Brass

SB:
Satin Brass

BRASS BISTRO SHELVING

Elevate your designs with the sophistication of Brass Bistro Shelving. Traditional, Contemporary and Cantilever Bistro Shelving Kits are stocked in Lacquered Polished Brass & Lacquered Satin Brass, with (5) custom finishes available*. Custom finishes include Antique Copper, Antique Brass, Flat Black, Satin Nickel, and Polished Nickel. Our Brass Bistro Shelving is easy to assemble with set screws and includes installation hardware and assembly instructions.

*Glass shelves not included. All Brass tubes are 1" Diameter. *Premium pricing applies for custom finishes.*

FLUSH



FOR 10" SHELVES:

3 SHELF
01FLUSH1036-1
42" high,
12.875" deep

4 SHELF
01FLUSH1048-1
56.5" high,
12.875" deep

FOR 12" SHELVES:

3 SHELF
01FLUSH1236-1
42" high,
14.875" deep

4 SHELF
01FLUSH1248-1
56.5" high,
14.875" deep

TRADITIONAL



FOR 10" SHELVES:

3 SHELF
01TRAD1036-1
42.25" high,
13.375" deep

4 SHELF
01TRAD1048-1
56.375" high,
13.375" deep

FOR 12" SHELVES:

3 SHELF
01TRAD1236-1
42.25" high,
15.375" deep

4 SHELF
01TRAD1248-1
56.375" high,
15.375" deep

We offer **Built-to-Order Bistro Shelving** in multiple configurations and finishes. Wall-to-floor, ceiling-to-countertop, and wall-to-countertop, you decide your connection points*, number of shelves and more by designing your own Built-to-Order Bistro Shelving. For Traditional and Contemporary Bistro Shelving styles, you can define the depth of your shelves (Cantilever arms have a fixed depth for use with 10" deep shelves).

*We do not offer ceiling-to-ceiling connection points.

**Unlacquered brass (due to its raw nature) will oxidize, causing a patina film to form, giving the brass a greenish look.

PLEASE NOTE: Premium pricing applies for custom finishes.

STOCK FINISHES

PB:
Polished Brass

SB:
Satin Brass

**Unlacquered
Brass

Antique Brass

Flat Black

Antique
Copper

Polished
Nickel

Satin Nickel

NEW! BRASS POT RAIL KITS

Available in Knurled and Plain styles. Comes in Lacquered Polished and Satin Brass and Flat Black finishes. Each kit includes all necessary rail components, assembly/installation hardware and six matching s-hooks. Heavy duty brass hooks available separately (QHOOK-1).

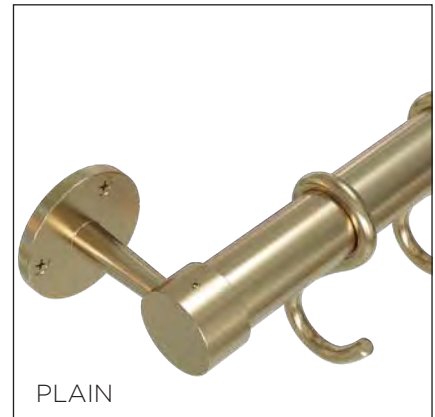

01POTRL-1-18 1" Diam. Pot Rail Kit - 18" L
01KPOTRL-1-18 Knurled Design, 1" Diam. Pot Rail Kit - 18" L
01RPOTRL-1-18 Reeded Design, 1" Diam. Pot Rail Kit - 18" L

01POTRL-1-24 1" Diam. Pot Rail Kit - 24" L
01KPOTRL-1-24 Knurled Design, 1" Diam. Pot Rail Kit - 24" L
01RPOTRL-1-24 Reeded Design, 1" Diam. Pot Rail Kit - 24" L

01POTRL-1-30 1" Diam. Pot Rail Kit - 30" L
01KPOTRL-1-30 Knurled Design, 1" Diam. Pot Rail Kit - 30" L
01RPOTRL-1-30 Reeded Design, 1" Diam. Pot Rail Kit - 30" L

01POTRL-1-36 1" Diam. Pot Rail Kit - 36" L
01KPOTRL-1-36 Knurled Design, 1" Diam. Pot Rail Kit - 36" L
01RPOTRL-1-36 Reeded Design, 1" Diam. Pot Rail Kit - 36" L

BRASS HOOK
 Pairs great with our Pot Rail Kit.

QHOOK-1
 Fits 1" diam. rod
 MUST BE PURCHASED SEPARATELY

3 styles, custom finishes & sizes available.

BRASS HARDWARE

PB:
Polished Brass

SB:
Satin Brass

WR:
Flat Black

NEW! BRASS CONTEMPORARY FOOT RAIL KITS

Add luxury and detail to home bars and kitchens with **Knurled Brass Foot Rail Kits** — crafted from **solid cast brass** with a **knurled** or **reeded texture**. Designed for residential scale with **1.5" diameter components**, kits are available in 4-ft, 5-ft, and 8-ft lengths. **Modular components** available, allowing for custom configurations and one-of-a-kind installations.

REEDED FOOT RAIL KITS



4' REEDED KIT INCLUDES:

- (1) 48" Pole
- (2) Floor Posts
- (2) End Caps
- (1) Center Post

01RFOTRL1PB1-48

5' REEDED KIT INCLUDES:

- (1) 60" Pole
- (2) Floor Posts
- (2) End Caps
- (2) Center Posts

01RFOTRL1PB1-60

8' REEDED KIT INCLUDES:

- (2) 48" Poles
- (2) Floor Posts
- (2) End Caps
- (3) Center Posts

01RFOTRL1PB1-96

CORNER CONNECTOR ADD-ON



01474150-1

1.389" x 3.425" x 3.425"

KNURLED FOOT RAIL KITS



4' KNURLED KIT INCLUDES:

- (1) 48" Pole
- (2) Floor Posts
- (2) End Caps
- (1) Center Post

01KFOTRL1PB1-48

5' KNURLED KIT INCLUDES:

- (1) 60" Pole
- (2) Floor Posts
- (2) End Caps
- (2) Center Posts

01KFOTRL1PB1-60

8' KNURLED KIT INCLUDES:

- (2) 48" Poles
- (2) Floor Posts
- (2) End Caps
- (3) Center Posts

01KFOTRL1PB1-96

CORNER CONNECTOR ADD-ON



01474150-1

1.389" x 3.425" x 3.425"

WARRANTY INFORMATION

Coverage

Products will be free from defects in materials and workmanship under normal household use.

Not Covered

- Neglect, misuse, accidents, alterations, extreme conditions
- Exposure to water, humidity, or outdoor use
- Post-sale finishing
- Faulty installation or utilization
- Natural aging, wear, fading, color variations
- Improper cleaning or storage

COMPONENT-SPECIFIC NOTES

Unfinished Wood

- Seal ends promptly
- Cracking from improper storage not covered
- Clean only with dry cloth or compressed air

Pre-Finished Wood

- Finish fading is natural and not covered
- Avoid ammonia, alcohol, or abrasive cleaners

Brass Components

- **Unlacquered:** Patina and oxidation expected (not covered)
- **Lacquered:** Clean gently to preserve finish

Electroplated Products

Color variation may occur between runs. Seamless match not guaranteed.

Anodized Aluminum

- Resistant to rust, but must be dried after cleaning
- Extended exposure to moisture voids warranty

UHB Tape & Designer DripEdge™

- Apply to clean surfaces with pressure
- Do not use in unsupported vertical applications

Gallery Rail

For display use only. Not structurally rated.

Samples & Sample Kits

For viewing only. Size/appearance may differ from final product.

Sustainable Materials

Rattan, resin, leather, mesh are prone to aging. Natural wear not covered.

Assembly/Installation

- Must be installed by responsible and experienced individuals
- Improper use or alteration voids warranty

All Sales Are Final

- Products from this catalog are outsourced and distributed by WalzCraft.
- Due to short wait times, some orders may enter production the same day they are received.
- Orders may only be canceled or changed if the request is received and confirmed prior to WalzCraft ordering the material.
- Approved changes may result in additional charges.
- Changing an order may extend wait times.
- Cut-to-Size items are not eligible for cancellation, return or refund.

SAFETY INFORMATION

SAFETY & PROPOSITION 65 INFORMATION

Safety & Handling Notice

At **Designs of Distinction™ by Brown Wood, Inc.®**, we are committed to delivering high-quality components and materials. Our products are designed to meet reasonable safety standards when handled with care and proper preparation.

Whether you're assembling, installing, or finishing an item, always follow included instructions and use basic safety practices. Personal protective equipment (PPE)—such as gloves, goggles, dust masks, and hearing protection—should be used when cutting, drilling, sanding, or applying finishes.

Improper handling or failure to follow instructions may result in injury or product damage.

Wood Products

Most of our hardwood products (e.g., columns, corbels, mouldings, legs, tambour) are sold unfinished. These may include splinters or loose fibers. Activities like sanding, cutting, or finishing generate dust and debris—use PPE and proper ventilation.

Finished wood with clear-coat or other finishes should be treated the same, with added care during sanding or thinning, as finishes may release chemical particles. Avoid inhalation or ingestion.

- Wood Dust - OSHA
- Sanding Safety - Purdue University
- Splinter Removal - Popular Woodworking
- Eye Safety - Mayo Clinic

California Proposition 65 Warning: Drilling, sawing, sanding, or machining wood products can expose you to wood dust, a substance known to the State of California to cause cancer. Use PPE and avoid inhaling dust. Learn more at www.P65Warnings.ca.gov/wood.

Metal Products

Our metal items—such as shelving, trim, feet, rails, and grilles—are made from brass, aluminum, or steel:

- **Brass** may contain fine dust or shavings and can be sharp when cut.
- **Aluminum** (sometimes anodized or coated) may release debris when worked.
- **Steel** grilles and mesh may buckle or create sharp fragments during handling or cutting.

Always use PPE and make sure you're familiar with your tools and procedures.

- Metal Cutting Safety - <https://www.metals4u.co.uk/blog/how-to-cut-metal-a-focus-on-safety>
- Powder Coating Safety - <https://www.tcipowder.com/resources/safety-compliance>
- Treating Metal Wounds - <https://www.mayoclinic.org/first-aid/first-aid-cuts/basics/art-20056711>

Other Materials

- **Rattan** is natural but may have surface residue—clean before use.
- **Resin** can release airborne particles when cut—use a dust mask and goggles.
- **Leather** may shed when trimmed—handle with care.
- **Glue & Tape** may contain chemicals—follow included directions and dispose of properly.

Use all products in a ventilated area and wear PPE suited to the task.

Safe Handling of Adhesives -

<https://www.adhesivesmag.com/articles/86751-safety-first-safe-handling-of-adhesives-and-sealants>

Recommended PPE (via Zoro Tools)

These are general-use items and do not guarantee safety:

- Work Gloves
- Safety Goggles
- Dust Masks / Respirators
- Aprons, Ear Protection, First Aid Kits & More

Final Reminder

Review all instructions before beginning any project, and only use tools and materials you are comfortable and familiar with. Your safety starts with preparation—use all products responsibly.

PART NUMBER INDEX

MATERIALS: TAMBOUR/ REEDED PANELS

011248100-1	2
011296100-1	2
012448100-1	2
011248101-1	2
011296101-1	2
011248102-1	2
011296102-1	2
012448102-1	2
011248103-1	2
011296103-1	2
011248104-1	2
011296104-1	2
011248105-1	2
011296105-1	2
011248106-1	2
011296106-1	2
011248107-1	2
011296107-1	2
012448107-1	2
011248110-1	2
011296110-1	2
012448110-1	2
011248302-1	3
011296302-1	3
012448302-1	3
011248304-1	3
011296304-1	3
012448304-1	3
011248402-1	3
011296402-1	3
012448402-1	3
011248403-1	3
011296403-1	3
012448403-1	3
011248201-1	4
011296201-1	4
011248202-1	4
011296202-1	4
011248203-1	4
011296203-1	4
012448203-1	4
011248204-1	4
011296204-1	4
011248206-1	4
011296206-1	4
011248207-1	4
011296207-1	4
012446100-1	5
012446102-1	5

012446107-1	5
012446110-1	5
012446127-1	5
012446302-1	5
012446304-1	5
012446402-1	5
012446403-1	5
014848127-1	6
019648127-1	6

MATERIALS: METAL ACCENT TRIM

010451-1-1181	8
01110451-1-12	8
01110451-1-14	8
010451-1-1481	8
01110451-1-15	8
01110451-1-17	8
010451-1-1781	8
010451-1-1875	8
010451-1-2050	8
010451-1-2081	8
010451-1-2175	8
010451-1-2350	8
010451-1-2384	8
01TP1875-54	8
01TP1875-8	8
01TP50-108	8
01TP50-8	8
01PEN-1	8
01110788-1	9
01110810-1	9
01200250-1	9
01110030-1	9
01110451-1	9
01-RAP7572-1	10
01110171-1	10
01HC1005-1	11
01HC1010-1	11
01HC1008-1	11
01990810-1	11
01HC1007-1	11

MATERIALS: CUT-TO-SIZE

012248MESH-1	13
014448MESH-1	13
013648M22-1	14
012472332P-1	14

013648332P-1	14
012472CG10-1	14
013648CG10-1	14

012472286S-1	14
013648286S-1	14
012472DK08-1	14
013648DK08-1	14
01247211614P-1	14
01364811614P-1	14

0124721214F-1	14
0136481214F-1	14
0136481220T-1	14

013648R332P-1	14
013648R614P-1	14

012472315C-1	14
013648315C-1	14

013648226-1	14
-------------	----

01SQ2472214F-1	15
01SQ3648214F-1	15
01SQ2472286S-1	15
01SQ3648286S-1	15

01SQ2472DK08-1	15
01SQ3624DK08-1	15
01SQ3648DK08-1	15
01SQ2472332P-1	15

01SQ3648332P-1	15
----------------	----

012472RE25-1	15
013648RE25-1	15

01DGRETAINDER	15
01103	16
01110	16
01107	16
01112	16
0124481802	16
0148481802	16
0124481803	16
0148481803	16
0124481804	16
0148481804	16
013202	17
013201	17
011202NT1	17
011203NT1	17
011204NT1	17
011201NT1	17
013216WR1	17
015618WR1	17
012652-1	17
0124481652-1	17
0148481652-1	17
0124482216-1	17
0148482216-1	17

POSTS & TABLE LEGS

01243029-1	20
01243024-6	20
01243018-6	20
01245129-1	20
01245124-1	20
01245118-1	20
01612010-1	21
01612010-3	21
01722910-1	21
01724529-1	21
01621025-1	21
01621025-3	21
01613010-1	21
01613025-1	21
01723001-1	22

01734529-1	22	01590224-1	27	01634010-1	32	01TRIKIT403-1	39
01724001-1	22	01590227-1	27	01735010-1	32	01EPS3025-1	40
01614010-1	22	01590223-1	27	01635010-1	32	01EPS3036-1	40
01614025-1	22	01590225-1	27	01636010-1	32	01EPT1525-1	40
01040127-1	22	01590228-1	27	01530310-1	33	01EPT1536-1	40
01040160-1	22	01520223-1	28	01540310-1	33	01EPT3025-1	40
01220160-1	22	01040270-1	28	01000310-1	33	01EPT3036-1	40
01110110-1	22	01040275-1	28	01160310-1	33	01EPAR1525-1	40
01060160-1	22	01110210-1	28	01240310-1	33		
01060110-1	23	01042760-1	28				
01510110-1	23	01040260-1	28	END PANELS		FURNITURE & BUN FEET	
01590122-1	23	01220260-1	28	01XPN3025LNG-1	35	01708310-1	42
01590124-1	23	01250210-1	28	01XPN3036LNG-1	35	01708010-1	42
01590127-1	23	01510228-1	28	01XPN1525LNG-1	35	01708110-1	42
01000110-1	23	01515028-1	28	01XPN1536LNG-1	35	01703110-1	42
01210110-1	23	01060260-1	29	01XPNL3025-1	35	01703010-1	42
01ANGLEPLATE	23	01060220-1	29	01XPNL3036-1	35	01703210-1	42
01STRAIGHTPLATE	23	01510210-1	29	01XPNL1525-1	35	01707410-1	43
01HDPLATE	23	01060210-1	29	01XPNL1536-1	35	01707440-1	43
01724500-1	24	01160210-1	29	01XPN3025LNG-4	36	01709010-1	43
01722010-1	24	01150220-1	29	01XPN3036LNG-4	36	01707710-1	43
01622010-3	24	01560210-1	29	01XPN1525LNG-4	36	01700457-1	44
01622025-3	24	01520210-1	29	01XPN1536LNG-4	36	01705710-1	44
01622025-1	24	01570217-1	30	01XPNL3025-4	36	01706065-1	44
01622010-1	24	01580217-1	30	01XPNL3036-4	36	01705080-1	44
01623010-1	24	01082710-1	30	01XPNL1525-4	36	01750460-1	44
01623025-1	24	01080210-1	30	01XPNL1536-4	36	01704060-1	44
01723010-1	24	01230210-1	30	01XBS34241	37	01700146-1	44
01734510-1	24	01080270-1	30	01XBS34361	37	01703510-1	44
01530210-1	25	01082740-1	30	01290180-1	37	01700627-1	44
01540210-1	25	01080240-1	30	01290280-1	37	01705860-1	44
01624010-1	25	01230240-1	30	01RADTBS2534-1	38	01705715-1	44
01624025-1	25	01082730-1	30	01RADTBS3634-1	38	01705175-1	45
01724010-1	25	01080230-1	30	01RADBS2534-1	38	01705610-1	45
01725010-1	25	01230230-1	30	01RADBS3634-1	38	01705112-1	45
01625010-1	25	01140210-1	30	01RECBASE-1	39	01705510-1	45
01606010-1	25	01625046-1	31	01RNDBASE345-1	39	01705810-1	45
01626010-1	25	01510204-1	31	01TRIBASE-1	39	01705225-1	45
01180210-1	26	01240210-1	31	01RECKIT100-1	39	01731010-1	45
01510202-1	26	01090215-1	31	01RECKIT302-1	39	01700310-1	45
01040240-1	26	01100211-1	31	01RECKIT304-1	39	01705110-1	45
01040210-1	26	01386050-1	31	01RECKIT402-1	39	01704075-1	45
01010285-1	26	01626050-1	31	01RECKIT403-1	39	01700210-1	45
01010280-1	26	01110218-1	31	01RNDKIT104-1	39	01706060-1	46
01020280-1	26	01100218-1	31	01RNDKIT106-1	39	01700018-1	46
01000210-1	27	01250310-1	32	01RNDKIT203-1	39	01705155-1	46
01210210-1	27	01510328-1	32	01RNDKIT206-1	39	01705150-1	46
01030210-1	27	01632010-1	32	01TRIKIT100-1	39	01700245-1	46
01470210-1	27	01633010-1	32	01TRIKIT302-1	39	01700245-6	46
01410210-1	27	01733010-1	32	01TRIKIT304-1	39	01700345-1	46
01590222-1	27	01734010-1	32	01TRIKIT402-1	39	01700345-6	46

01705310-1	47			01601300-1	55	CREATE-A-COLUMN™/HALF ROUND MOULDINGS & CORNER MOULDINGS		
01760410-1	47	01244006-1	48	01601100-1	55		01RADCRN297-1	63
01704210-1	47	01244009-6	48	01607004-1	55		01RADCRN397-1	63
01706010-1	47			01607001-1	55		01RADCRN697-1	63
01702510-1	47	01244009-1	48	01607005-1	55		01962010-2	64
01700015-1	47	01700400-1	49	01607117-1	56		01961510-2	64
01704110-1	47	01700402-1	49	01607217-1	56		01961530-2	64
01704010-1	47	01700012-1	49	01607317-1	56		01961540-2	64
01704040-1	47	01700905-1	49	01604510-1	56		01962040-2	64
01704910-1	47	01700408-1	49	01606002-1	56		01961520-2	64
01240006-6	48	01700406-1	49	01606001-1	56		01962020-2	64
		01700412-1	49	01608009-1	57		01391510-2	65
01240006-1	48	01700410-1	49	01608007-1	57		01311510-2	65
01240009-6	48	01700401-1	49	01608010-1	57	01312010-2	65	
		01704017-1	49	01608008-1	57	01331510-2	65	
01240009-1	48	01706018-1	49	01608001-1	57	01332010-2	65	
01241006-6	48	01FRS1010-1	50	01601205-1	57	01321510-2	65	
		01FRS1254-1	50	01601204-1	57	01322010-2	65	
01241006-1	48	01FRC1010-1	50	01601203-1	57			
01241009-6	48	01FRC1040-1	50	01607010-1	58	DECORATIVE MOULDING & PILASTERS		
		01SLV245-1	50	01607011-1	58		01SHIPLAP-1	67
01241009-1	48	01SLV345-1	50	01607316-1	58		01827578-1	67
01242006-1	48	01SLV2-1	50	01607216-1	58		01807375-1	67
01242006-6	48	01SLV3-1	50	01901005-1	58		01807500-1	67
		01SLV4-1	50	01901003-1	58		01807000-1	67
01242009-1	48	01SLV5-1	50	01607315-1	58		01806000-1	67
01242009-6	48	01SLPR106-1	50	01607215-1	58		01MB867510-1	67
		01SLPR105-1	50	01901105-1	59		01MB867520-1	67
01221006-6	48	01SLPR104-1	50	01901001-1	59		01384210-2	67
				01901002-1	59		01384240-2	67
01221009-6	48	BRACKETS & CORBELS		01901107-1	59		01386050-1	67
		01ARCHKNLD1-1	52	01901009-1	59			
01222006-6	48	01ARCHPLN1-1	52	01600928-1	59	SHELVING		
		01600016-1	52	01600628-1	59	01MFL103030-1	69	
01223006-6	48	01600006-1	52	01601427-1	60	01MFL102424-1	69	
		01651270-1	52	01600927-1	60	01MSH123030-1	69	
01223009-6	48	01605006-1	53	01600627-1	60	01MSH122424-1	69	
		01605007-1	53	01600318-1	60	01MFL102410-1	69	
01245106-6	48	01605008-1	53	01904991-1	60	01MFL103610-1	69	
		01605009-1	53	01904990-1	60	01FL102410-1	70	
01245106-1	48	01600300-1	53	01901004-1	60	01FL103610-1	70	
01245109-6	48	01607012-1	53	01904993-1	60	01CHSHLF0424-1	70	
		01600001-1	54	01605001-1	61	01CHSHLF0436-1	70	
01245109-1	48	01600002-1	54	01605000-1	61	01CHSHLF0448-1	70	
		01600003-1	54	01605005-1	61	01CHSHLF0460-1	70	
01243006-6	48	01600009-1	54			01CHSHLF0624-1	70	
01243006-8	48	01607009-1	54			01CHSHLF0636-1	70	
01243009-6	48	01607008-1	54			01CHSHLF0648-1	70	
		01607006-1	54					
01243009-1	48	01607007-1	54					
01244006-6	48	01601400-1	55					

01981515WR1	71
01982222WR1	71
01980109WR1	71
01981022WR1	71
01980116WR1	71

OUTLETS & VENTS

01450002-1	73
01451002-1	73
01450003-1	73
01451003-1	73
01453003-1	73
01454003-1	73
01450001-1	73
01451001-1	73
01453001-1	73
01454001-1	73
01450012-1	74
01451012-1	74
01450013-1	74
01451013-1	74
01452001-1	74
01452002-1	74
01992114-1	75
01992110-1	75
01992124-1	75
01992112-1	75
01992214-1	75
01992224-1	75
01992210-1	75
01992212-1	75
01992010-1	76
01992012-1	76
01992014-1	76
01992024-1	76
01994014-1	76
01994012-1	76
01994010-1	76

DECORATIVE BRASS

HARDWARE

01KCANT1036-1	85
01KCANT1048-1	85
01RCANT1036-1	85
01RCANT1048-1	85
01CANT1036-1	85
01CANT1048-1	85
01FLUSH1036-1	86
01FLUSH1048-1	86
01FLUSH1236-1	86
01FLUSH12361	86
01FLUSH1248-1	86
01FLUSH12481	86
01TRAD1036-1	86
01TRAD1048-1	86
01TRAD1236-1	86
01TRAD1248-1	86
01POTRL1-1-18	87
01POTRL1-1-24	87
01POTRL1-1-30	87
01POTRL1-1-36	87
01KPOTRL1-1-18	87
01KPOTRL1-1-24	87
01KPOTRL1-1-30	87
01KPOTRL1-1-36	87
01RPOTRL1-1-18	87
01RPOTRL1-1-24	87
01RPOTRL1-1-30	87
01RPOTRL1-1-36	87
01QHOOK-1	87
01RFOTRL1-1-48	88
01RFOTRL1-1-60	88
01RFOTRL1-1-96	88
01KFOTRL1-1-48	88
01KFOTRL1-1-60	88
01KFOTRL1-1-96	88
01474150-1	88

GALLERY RAIL

01HC9001-1	82
01HC9002-1	82
01HC9003-1	82
01HC900436-1	82
01HC9014-1	83
01HC9015-1	83
01HC9016-1	83
01HC9024-1	83
01HC9025-1	83
01HC9026-1	83



WARNING!



Designs of Distinction[®]'s "rigid" (formerly solid) style beaded insert panels have been manufactured to be used as center panel inserts for frames only. Due to the machined profile of the panel and the material's thinness, this product is not recommended for use without being captured within a frame.

If installed as a center panel insert into a frame, you should allow for movement of the panel within the frame - to account for the natural expansion and contraction of the material. When finishing, the product should be finished on both sides and allowed to air dry. **DO NOT OVEN DRY.**

Should you choose to use our rigid panels as a stand-alone item, you can minimize movement by attaching the panel to a 1/4" - 3/8" backer. However, this does NOT guarantee completely stable product and will not be warranted by Designs of Distinction.

For onlay applications - such as walls, hoods or cabinet wraps - we recommend our flexible panel products. Flexible beaded panels consist of individual staves, glued to a flexible canvas or paper backer. Because they are individual staves, they move independently of each other and do not cause stress across the panel.

Please note: Panels that are exposed to extreme variations in humidity, i.e.: fireplace surround, oven hood, or in a bathroom will have greater expansion and contraction regardless of the finish applied or method of construction.

Designs of Distinction's warranty covers products installed and finished per the recommendations above for 1 year after purchase. It is recommended that products exposed to humidity changes be resealed periodically to reduce the loss of moisture.

Cut-to-Size Decorative Grille & Mesh Kit



- **SKU: 01DGMESHSAMPLE**
- Decorative Grille & Mesh samples enclosed in 5" x 5" envelopes, clearly labeled with style and finish.
- Includes (1) of each electroplated hand-woven Decorative Grille & Mesh we carry.
- Italian Mesh, Rattan, Resin, and Leather Kits can be added.
- Finishes vary.

Cut-to-Size Materials Showroom Display



- **SKU: 01CTSFRAME-25**
- 31.5"H x 31.5"W
- White frame including 24 cut-to-size materials of your choice.
- Finishes vary.
- Hanging hardware included.

Cut-to-Size Decorative Grille & Mesh Countertop Display

- **SKU: 01GRILLECOUNTER**
- (100) Cut-to-Size Brochures
- (1) Countertop Display Tray
- Decorative Grille & Mesh samples enclosed in 5" x 5" envelopes, clearly labeled with style and finish.
- Includes (1) of each electroplated hand-woven Decorative Grille & Mesh, Italian Mesh, and Fine Wire Mesh styles we carry.
- Finishes vary.



Leather Sample Kit (01LEATHERSMPL)



4" x 4" Squares
Includes samples of all leather styles & colors.

Resin Sample Kit (01RESINSMPL)



4" x 4" Squares
Includes samples of all resin styles & colors.

Italian Mesh Sample Kit (01ITALSMPL)



4" x 4" Squares. Includes all styles of our Italian Mesh.

Rattan Sample Kit (01RATTANSMPL)



4" x 4" Squares
Includes samples of all rattan styles & colors.

Your Guide to Sample Kits with Designs of Distinction®

All Metallic Trim Kits include 12" sample pieces in each finish we offer, clearly labeled with sku & finish. Trim Kits are placed in a roll-up pouch to protect from scratches and fingerprints. Double-sided UHB tape is not included and can be purchased separately. *Images of roll-up pouch coming soon!*

Stock Finishes						NEW SWATCH COMING SOON! 		
Finish Name	Brushed Aluminum	Chrome	Polished Brass	Satin Brass	Satin Stainless	Titanium *NEW 2024*	Warm Bronze	Flat Black
Finish Code	BA	CR	PB	SB	ST	TM	WB	WR

.25" Aluminum Bar



SKU: 01110810SMPL
Kit includes a 12" sample of our .25" x .25" Aluminum Bar in each finish we offer.



.5" Aluminum L-Channel



SKU: 01110030SMPL
Kit includes a 12" sample of our .5" Aluminum L-Channel in each finish we offer.



.75" Aluminum Strap



SKU: 01STRAP75SMPL
Kit includes a 12" sample of our .75" Aluminum Strap in each finish we offer.



.75"W x .25"T Aluminum Bar



SKU: 01110788SMPL
Kit includes a 12" sample of our .75"W x .25"T Aluminum Bar in each finish we offer.



.875" Aluminum L-Channel



SKU: 01110451SMPL
Kit includes a 12" sample of our .875" Aluminum L-Channel in each finish we offer.



1.25"W Aluminum Strap



SKU: 01110171SMPL
Kit includes a 12" sample of our 1.25"W Aluminum Bar in each finish we offer.



Angled Decorative Bar



SKU: 01200250SMPL
Kit includes a 12" sample of our 1.25"W Aluminum Bar in each finish we offer.



Metal Trim Kit (Aluminum and Brass)

- **SKU: 01METALTRIM**
- Kit includes a 12" sample of each Metallic Trim piece we offer, including Brass trim.
- (8) total pieces.
- (1) Roll-up pouch.
- Finishes vary.



Metallic Color Chips

- **SKU: 01METALSAMPLE**
- 3.75"W x 8.5"L card.
- 1.25"W x 1"H anodized aluminum metallic chips.
- All finishes represented.



Single Metallic Color Chip

- **SKU: 01METALSAMPLE**
- Must add finish code (noted below) to end of SKU when ordering.
- 2"W x 5.5"L card.
- (1) 1.25"W x 1"H anodized aluminum metallic chip.
- (1) color per card.



Designer DripEdge® Color Chips

- **SKU: 01DRIPEDGECLR**
- 2"W x 4.5"L card.
- (3) 1.25"W x 1"H anodized aluminum metallic chips in Satin Brass, Brushed Aluminum and Flat Black.
- All finishes offered for Designer DripEdge® represented for a total of 3 color chips.



Designer DripEdge Sample Kit

SKU: 01DRIPEDGESMPL

KBB PRODUCT AWARDS 2023 WINNER

The complete Sample Kit for our 2023 KBB Product Award-winning product, the Designer DripEdge®.

Includes:

- (1) 12.75"L DripEdge in flat black.
- (1) Promotional Table Tent.
- (1) DripEdge Color Chip Card.
- (1) Felt pouch.

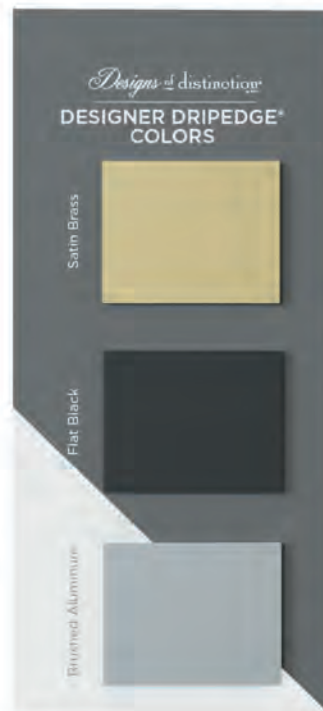

Tambour Only Sample Box (01TAMBOURBOX)



- Includes 3" x 4" samples of each of our available solid & flexible tambour profiles for a total of (27) sample pieces.
- Tambour species may vary.
- (10) Tambour brochures.

Countertop Tambour Display (01TAMBOURCNTR)



- (100) Tambour brochures.
- (2) Countertop display trays.
- (27) 6"W x 9"H flexible & solid Tambour samples, representing all Tambour profiles we carry.

12" X 24" Flexible Tambour Sample

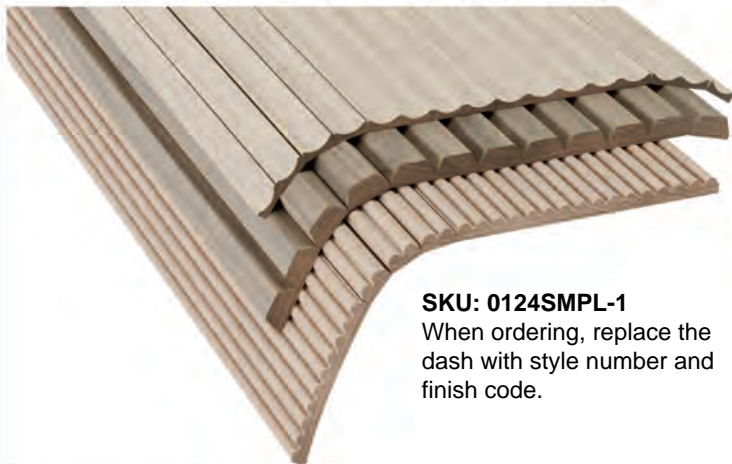

SKU: 0124SMPL-1
When ordering, replace the dash with style number and finish code.

Choose any flexible Tambour style and species.
Includes (1) 12"W x 24"L flexible Tambour piece.

12" X 24" Solid Tambour Sample

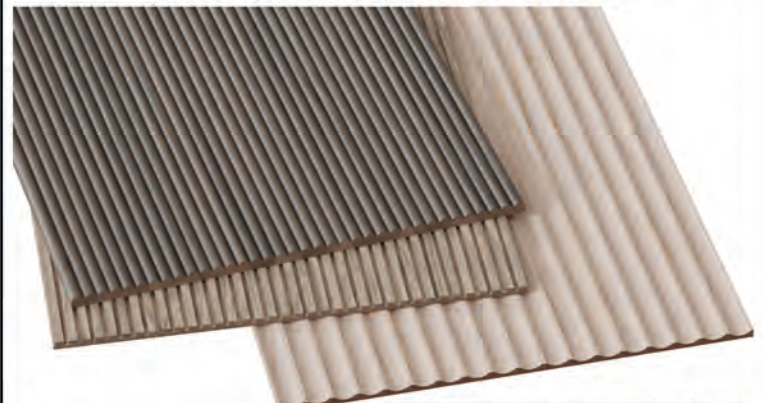

SKU: 01SLDSMPL-1
When ordering, replace the dash with style number and finish code.

Choose any solid Tambour style and species.
Includes (1) 12"W x 24"L solid Tambour piece.

Tambour Sample Binder



- **SKU: 01TAMBOURBINDER**
- Real American hardwood tambour samples affixed to a rigid tri-fold binder.
- Conveniently sized at 10"W x 12"H x 2"D to fit on bookshelves.
- Clear vinyl sleeve on back of binder to include your business information.
- QR code to download product images, specifications, installation instructions, and more.

Individual Tambour Samples



Tambour samples are clearly labeled with profile, style, and species.

10 Piece Gallery Rail Sample Kit



- **SKU: 01GALLERYRLMINI**
- (1) 12" sample rod in each finish we offer - Satin Brass, Polished Brass, Chrome, Flat Black, and Lacquered Stainless Steel - for a total of (5) rods.
- (5) Traditional end posts in each finish we offer.
- (1) Contemporary Gallery Rail post.

20 Piece Gallery Rail Sample Kit



- **SKU: 01GALLERYRLSET**
- (1) 12" sample rod in each finish we offer - Satin Brass, Polished Brass, Chrome, Flat Black, and Lacquered Stainless Steel - for a total of (5) rods.
- (15) posts - one in each style & finish.
- (1) Contemporary Gallery Rail corner collar.

4 Piece Traditional Gallery Rail Set - Chrome (CR)



SKU: 01GALLERYRAILCR

Kit includes (1) of each traditional gallery rail component in Chrome: end post, center post, corner post, 12" rod.

4 Piece Traditional Gallery Rail Set - Polished Brass (PB)



SKU: 01GALLERYRAILPB

Kit includes (1) of each traditional gallery rail component in Polished Brass: end post, center post, corner post, 12" rod.

4 Piece Traditional Gallery Rail Set - Satin Brass (SB)



SKU: 01GALLERYRAILSB

Kit includes (1) of each traditional gallery rail component in Satin Brass: end post, center post, corner post, 12" rod.

4 Piece Traditional Gallery Rail Set - Flat Black (WR)



SKU: 01GALLERYRAILWR

Kit includes (1) of each traditional gallery rail component in Flat Black: end post, center post, corner post, 12" rod.

4 Piece Single Contemporary Gallery Rail Set - Chrome (CR)



SKU: 01CONTRAILCR

Kit includes (1) of each contemporary gallery rail component in Chrome: end post, center post, corner collar, 12" rod.

4 Piece Single Contemporary Gallery Rail Set - Polished Brass (PB)



SKU: 01CONTRAILPB

Kit includes (1) of each contemporary gallery rail component in Polished Brass: end post, center post, corner collar, 12" rod.

4 Piece Single Contemporary Gallery Rail Set - Satin Brass (SB)



SKU: 01CONTRAILSBS

Kit includes (1) of each contemporary gallery rail component in Satin Brass: end post, center post, corner collar, 12" rod.

4 Piece Single Contemporary Gallery Rail Set - Flat Black (WR)



SKU: 01CONTRAILWR

Kit includes (1) of each contemporary gallery rail component in Flat Black: end post, center post, corner collar, 12" rod.

4 Piece Single Contemporary Gallery Rail Set - Stainless Steel (SS)



SKU: 01CONTRAILSS

Kit includes (1) of each contemporary gallery rail component in Stainless Steel: end post, center post, corner collar, 12" rod.

4 Piece Double Contemporary Gallery Rail Set - Chrome (CR)



SKU: 01DBLCONTRAILCR

Kit includes (1) of each double contemporary gallery rail component in Chrome: end post, center post, corner collar, 12" rod.

4 Piece Double Contemporary Gallery Rail Set - Polished Brass (PB)



SKU: 01DBLCONTRAILPB

Kit includes (1) of each double contemporary gallery rail component in Polished Brass: end post, center post, corner collar, 12" rod.

4 Piece Double Contemporary Gallery Rail Set - Satin Brass (SB)



SKU: 01DBLCONTRAILSBS

Kit includes (1) of each double contemporary gallery rail component in Satin Brass: end post, center post, corner collar, 12" rod.

4 Piece Double Contemporary Gallery Rail Set - Flat Black (WR)



SKU: 01DBLCONTRAILWR

Kit includes (1) of each double contemporary gallery rail component in Satin Brass: end post, center post, corner collar, 12" rod.

4 Piece Double Contemporary Gallery Rail Set - Stainless Steel (SS)



SKU: 01DBLCONTRAILSS

Kit includes (1) of each double contemporary gallery rail component in Satin Brass: end post, center post, corner collar, 12" rod.

Showroom Materials Box

- **SKU: 01SAMPLEBOX22A**
- (50) brochures of each style (250 total)
- (1) Tambour Sample Kit
- (1) Decorative Grille & Mesh Sample Kit
- (1) 10 Piece Gallery Rail Kit
- (1) Italian Mesh Sample Kit
- (1) Metal Trim Kit
- (1) Leather Sample Kit
- (1) Resin Sample Kit
- (1) Rattan Sample Kit
- (1) Designer DripEdge Sample Kit
- (1) Showroom Materials Display Box



Create Your Own Full Sample Kit by combining any of our sample kits together. We will package in a Showroom Box and include all relevant marketing materials.

Architect & Designer Client Sample Box

- **SKU: 01ADSAMPLE**
- (2) brochures of each style (10 total)
- (1) Diamond Weave Decorative Grille (DK08 double-sided grille)
- (1) Chevron Italian Mesh (style 107)
- (3) Tambour samples (1 bead style, 1 cove style, 1 square style - flexible & solid)
- (7) Metallic Trim samples
- (1) Rattan sample
- (1) Display Box



Create Your Own Client Sample Kit. Simply send us a list of samples you'd like to include in your A&D Client Sample Box. We will package in a Display Box and include all relevant marketing materials.

Metallic Trim Sample Door Kit B

- **SKU: 01TRIMDOORB**
- Kit includes (1) 14" x 14" door, routed to fit all trim styles.
- (1) 3.75"W x 8.5"L aluminum color chip card with all (8) finishes we offer (01METALSAMPLE).
- 6" sample of each aluminum Metallic Trim piece we offer for a total of (7) trim pieces in flat black.
- (1) 12.75"L Designer DripEdge® in flat black.
- (25) Metallic Accent Trim Brochures.
- (1) cinch bag and (1) roll-up pouch.
- (1) canvas tote for travel (image coming soon).

