



2248 Crown Molding
Cherry Wood - Java V2 Combination Stain



2258 Crown Molding
Cherry Wood - Honey Wiping Stain



1346 Crown Molding
Maple Wood - Eggshell SolidTone®

Chapter N Table of Contents

Section #	Section Name /Contents	Page #
N.1	Crown Molding	N.1.3
N.2	Refacing Molding	N.2.1
	◦ Miscellaneous Refacing Molding	N.2.2
	◦ Solid Wood Refacing Stock	N.2.3
N.3	Corner & Scribe Molding	N.3.1
	◦ Outside Corner Molding	N.3.1
	◦ Inside Corner Molding	N.3.2
	◦ Cove Molding	N.3.2
	◦ Base Shoe/Trim & Quarter Round Molding	N.3.2
	◦ Scribe Molding	N.3.3
	◦ Panel Splice Molding	N.3.3
	◦ 45° & 90° Transition Molding	N.3.3
N.4	Base & Casing Molding	N.4.1
N.5	Applied Molding	N.5.1
	◦ Applied Moldings - Outside Edge	N.5.1
	◦ Applied Moldings - Inside Edge/Shelf / Face	N.5.3
	◦ Old World Applied Moldings - Inside Edge/Shelf	N.5.10
	◦ No-Panel Cut Frame Only Door Molding	N.5.11
N.6	Mullion Stock Molding	N.6.1
N.7	Column Molding	N.7.1
	◦ Half & Quarter Round Column Moldings - Smooth	N.7.1
	◦ Half Round Column Molding - Reed	N.7.1
	◦ Half & Quarter Round Column Molding-Fluted	N.7.2
	◦ ¼" Beaded Column Moldings	N.7.3
	◦ ⅜" Beaded Column Moldings	N.7.4
	◦ Elliptical Column Moldings	N.7.5
	◦ Pyramid Column Moldings	N.7.5
	◦ Reed Column Moldings	N.7.6
	◦ Miscellaneous Column Molding	N.7.6
	◦ Round Column Wrap Molding - Smooth Face	N.7.7
◦ Round Column Wrap Molding - Fluted Face	N.7.10	
N.8	Wainscot Molding	N.8.1
	◦ Wainscot Cap /Backband Moldings	N.8.1
N.9	Miscellaneous Molding	N.9.1
	◦ Color Block Molding	N.9.1
	◦ Door Jamb Stop Molding	N.9.1
	◦ Window Sill Moldings	N.9.1
	◦ Louvered Slat Molding (Non-Operable)	N.9.2
	◦ Louvered Slat Molding (Operable)	N.9.2
	◦ Operable Louver Actuator Molding	N.9.2
	◦ Inset Bead Molding	N.9.2
	◦ Square Peg Molding	N.9.2
	◦ Beaded Molding	N.9.3
	◦ Miscellaneous Molding	N.9.3



2179 Canopy Molding
Cherry Wood - Fruitwood Wiping Stain
(# 942 Crown Molding Match Also Available)

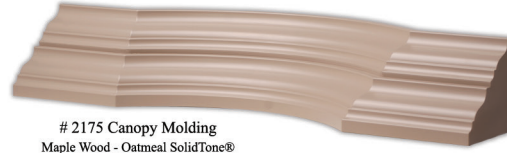

2175 Canopy Molding
Maple Wood - Oatmeal SolidTone®
(# 1860 Crown Molding Match Also Available)

Chapter N Table of Contents...continued

Section #	Section Name/Contents	Page #
N.9	Miscellaneous Molding...continued	N.9.1
	◦ Finger Pull Molding - 5/8" Thick Door	N.9.4
	◦ Finger Pull Molding - 3/4" Thick Door	N.9.4
	◦ Drawer Glide Spacer Molding	N.9.4
	◦ Step Molding	N.9.4
	◦ Wood Retainer Molding	N.9.5
	◦ GRF Filler Molding	N.9.5
	◦ GRF Extension Molding	N.9.7
	◦ Shelf Bullnose Molding	N.9.8
	◦ Edgeband Molding	N.9.8
	◦ Countertop Edge Molding	N.9.8
	◦ Under Cabinet (Light Rail) & Over Cabinet Moldings	N.9.9
	◦ Spice Rack Molding	N.9.14
	◦ Tiered Spice Drawer Molding	N.9.14
	◦ Drawer Box Divider Molding	N.9.14
	◦ Pencil Tray Molding	N.9.14
	◦ Fireplace Surround Molding	N.9.15
	◦ Frieze Molding	N.9.15
	◦ Plate Display Molding	N.9.15
	◦ Wine Rack Molding	N.9.15
	◦ Half Lap Molding	N.9.16
	◦ Astragal Molding	N.9.16
	◦ Dentil / Accent Molding	N.9.17
	◦ Chair Rail Molding	N.9.17
	◦ Retail Price Tag Molding	N.9.17
	◦ Dowel Molding	N.9.18
◦ Pyramid Molding	N.9.18	
◦ Bar Rail Molding	N.9.19	
◦ Stemware Molding	N.9.22	
◦ Tambour Molding	N.9.24	
◦ Plate Rail Molding	N.9.24	
N.10	Arched Canopy Styles/Molding	N.10.1
	◦ Arched Canopy Styles	N.10.1
	◦ Arched Canopy Molding with Matching Crown Molding	N.10.3
N.11	Precision Molded Wood Flooring	N.11.1
	◦ Precision Molded 3/4" Wood Flooring	N.11.1
	◦ 3/4" Wood Flooring Transition Molding	N.11.1
	◦ Precision Molded 5/8" Wood Flooring	N.11.2
	◦ 5/8" Wood Flooring Transition Molding	N.11.2
N.12	Molding Notes	N.12.1
N.13	Outsourced Molding	N.13.1
	◦ Bead, Egg & Dart, and Plain Molding - Embossed	N.13.1
	◦ Half Round and Quarter Round Rope Molding	N.13.1
	◦ Plate Rail Turned Spindle	N.13.4

Crown Molding - Abbreviations and Symbols

The following symbols and abbreviations may appear on profile drawings in this section and indicate the following:

- (X) Molding can accept an additional accent or dentil molding (See *Section N.9* for options).
- (D) Depth of molding when installed.
- (H) Height of molding when installed.
- FRC Fastener Relief Cut.
- \sphericalangle Spring Angle
- \square Molding is available convex/concave.
- ★ Molding is available with 3D laminate (RTF)

Note: All moldings are drawn at full scale unless noted otherwise.

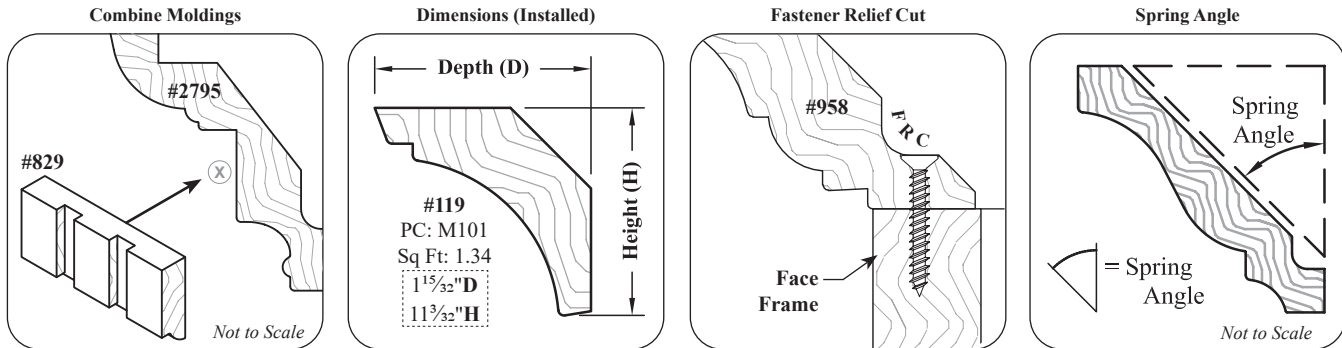

Crown Molding

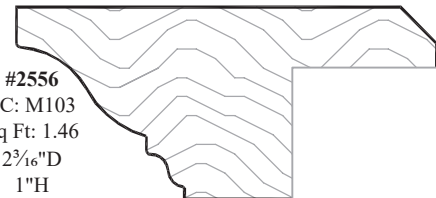
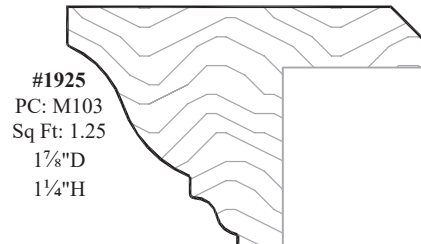
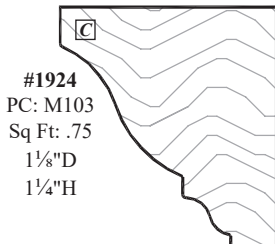
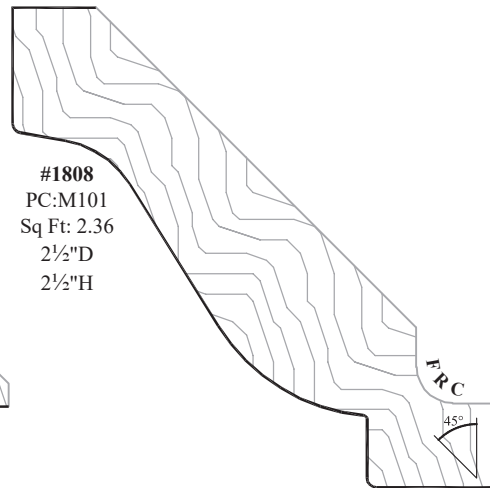
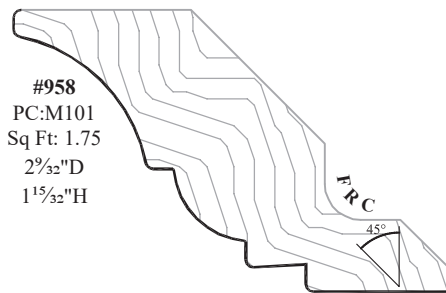
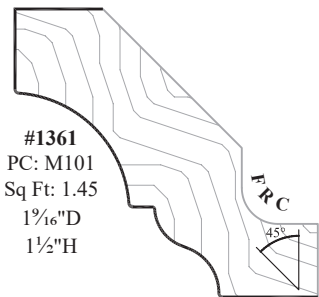

FRC = Fastener Relief Cut. \square = Available for Convex/Concave products. ★ = Available with 3D Laminate/RTF.

► For PRICING ► See Section N.1 in our current Wholesale Pricing Catalog.

Crown Molding

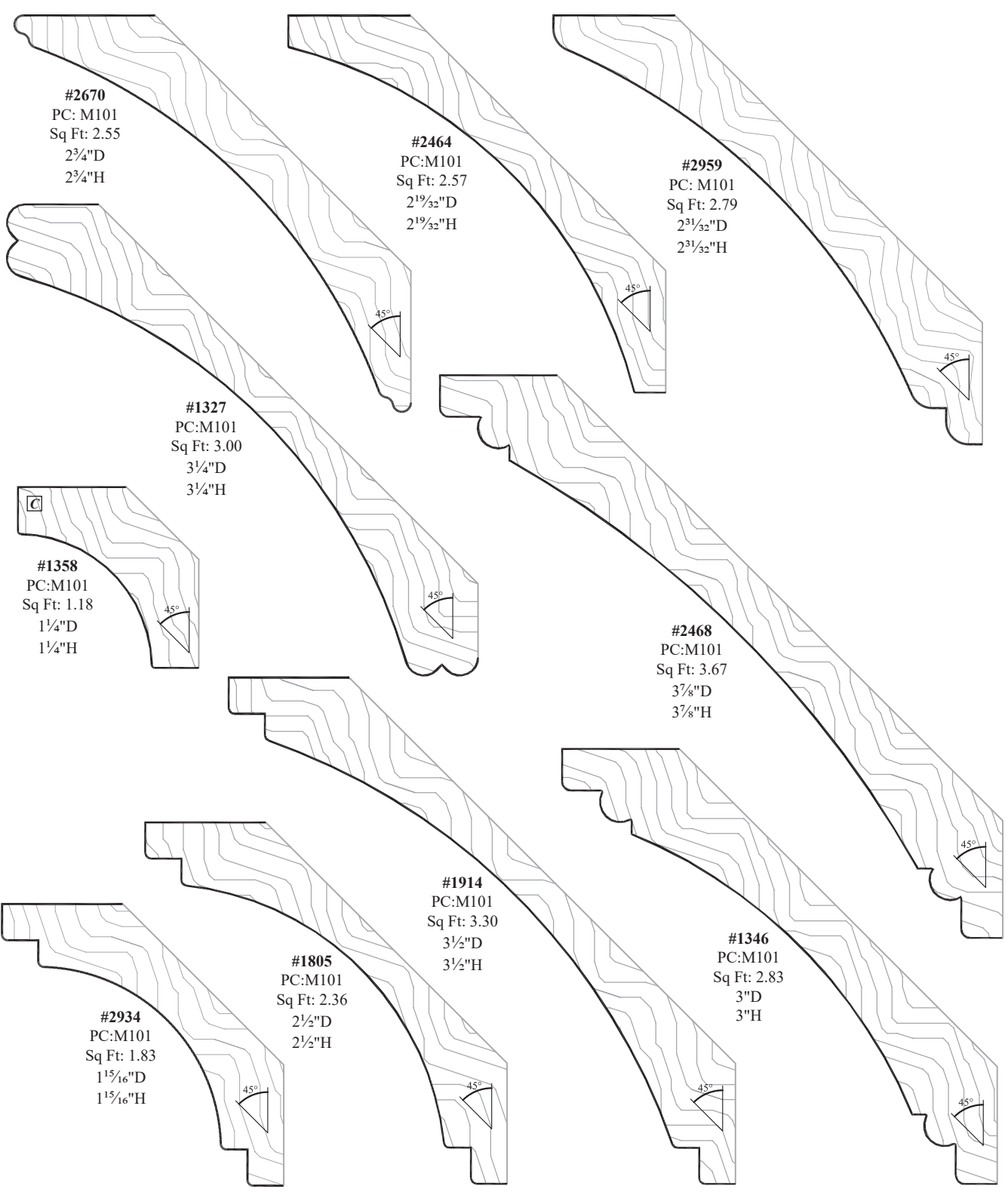

#2670
PC: M101
Sq Ft: 2.55
2³/₄"D
2³/₄"H

#2464
PC: M101
Sq Ft: 2.57
2¹/₃₂"D
2¹/₃₂"H

#2959
PC: M101
Sq Ft: 2.79
2³¹/₃₂"D
2³¹/₃₂"H

#1327
PC: M101
Sq Ft: 3.00
3¹/₄"D
3¹/₄"H

#1358
PC: M101
Sq Ft: 1.18
1¹/₄"D
1¹/₄"H

#2468
PC: M101
Sq Ft: 3.67
3⁷/₈"D
3⁷/₈"H

#1914
PC: M101
Sq Ft: 3.30
3¹/₂"D
3¹/₂"H

#1346
PC: M101
Sq Ft: 2.83
3"D
3"H

#2934
PC: M101
Sq Ft: 1.83
1¹⁵/₁₆"D
1¹⁵/₁₆"H

#1805
PC: M101
Sq Ft: 2.36
2¹/₂"D
2¹/₂"H

FRC = Fastener Relief Cut.

☐ = Available for Convex/Concave products.

★ = Available with 3D Laminate/RTF.

► For PRICING ► See Section N.1 in our current Wholesale Pricing Catalog.

Crown Molding

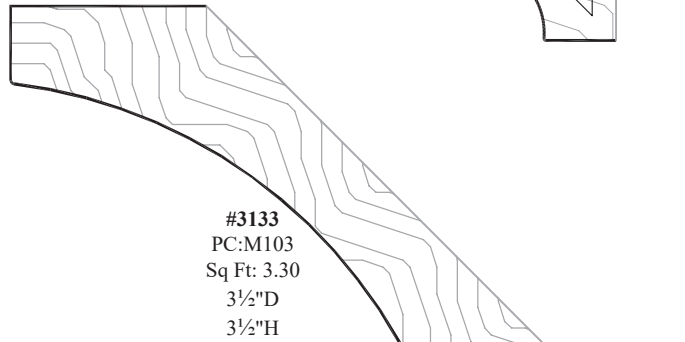
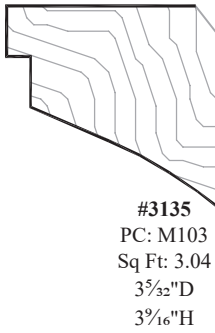

FRC = Fastener Relief Cut. = Available for Convex/Concave products. ★ = Available with 3D Laminate/RTF.

► For PRICING ► See Section N.1 in our current Wholesale Pricing Catalog.

Crown Molding

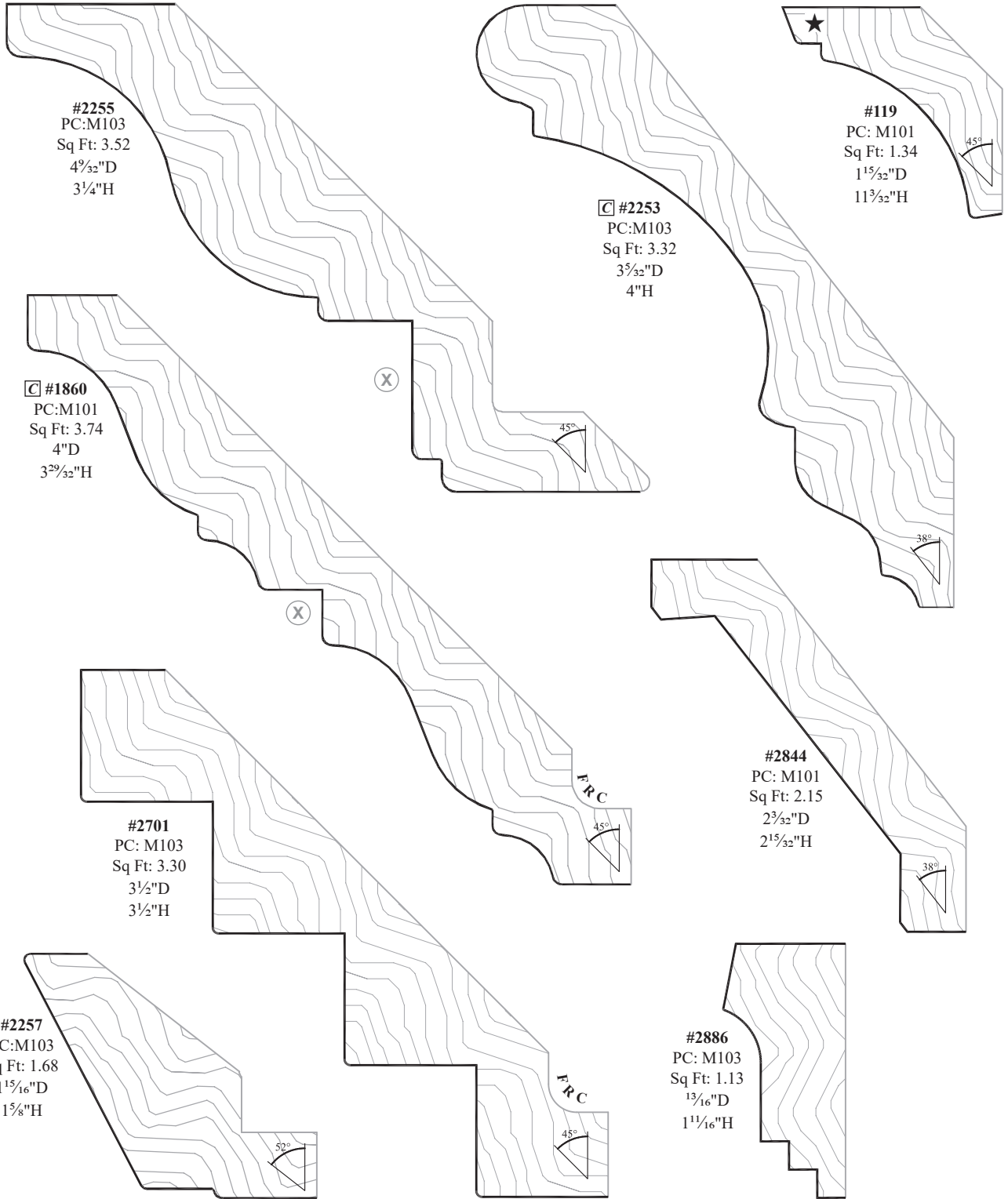

FRC = Fastener Relief Cut. **C** = Available for Convex/Concave products. ★ = Available with 3D Laminate/RTF.

► For PRICING ► See Section N.1 in our current Wholesale Pricing Catalog.

Crown Molding

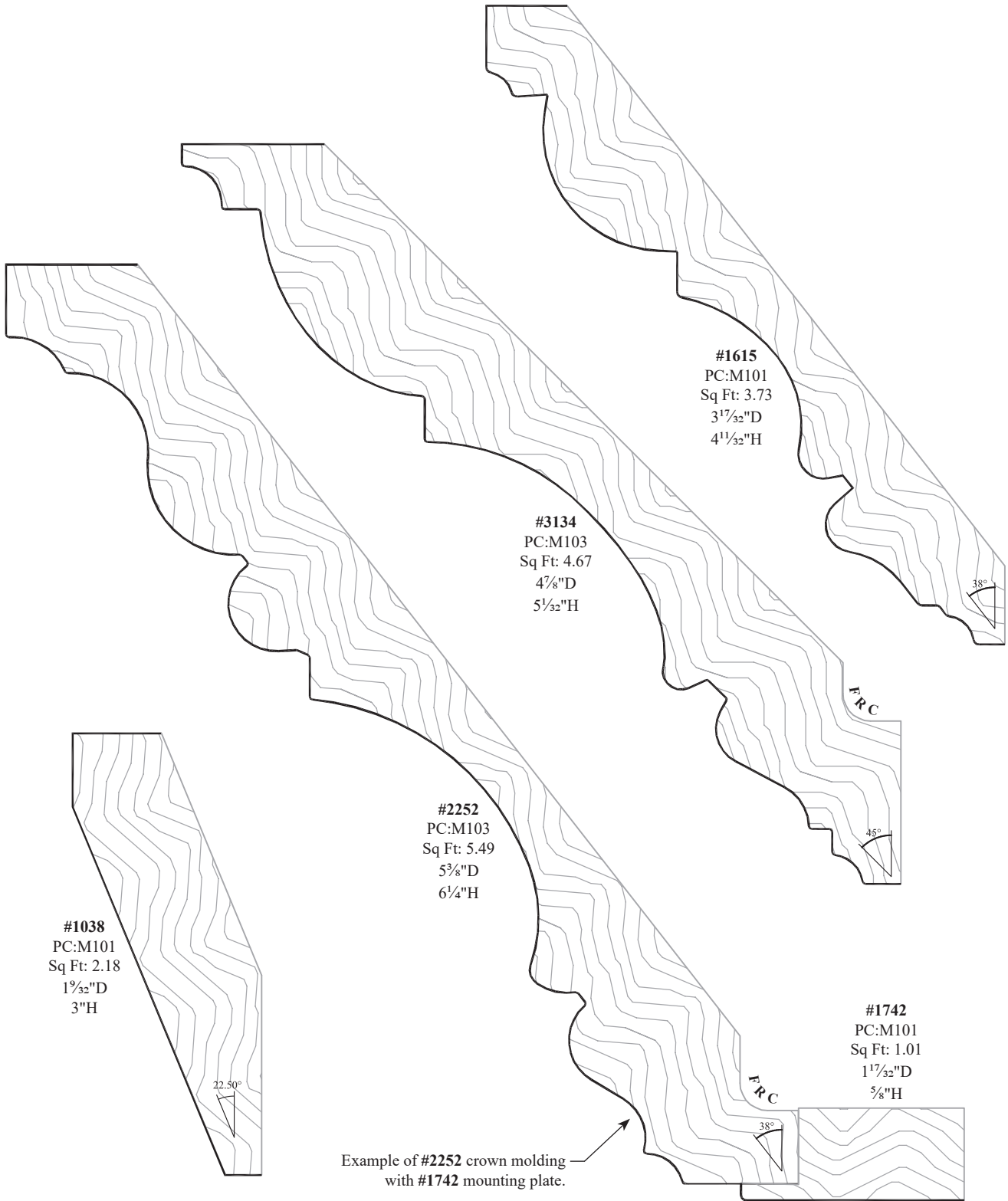

N

FRC = Fastener Relief Cut.

= Available for Convex/Concave products.

= Available with 3D Laminate/RTF.

► For PRICING ► See Section N.1 in our current Wholesale Pricing Catalog.

Crown Molding

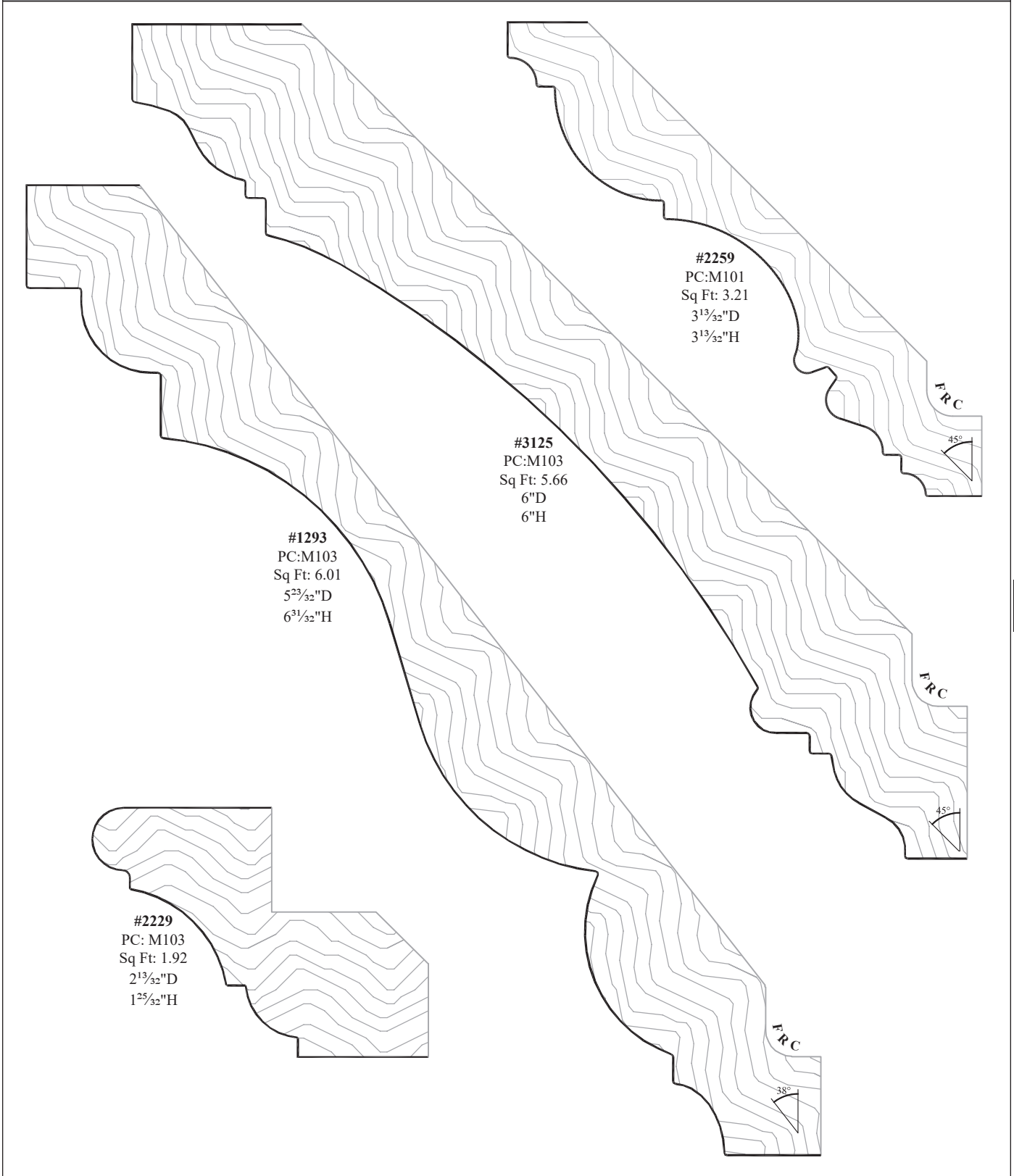

#2259
PC:M101
Sq Ft: 3.21
3¹³/₃₂"D
3¹³/₃₂"H

#3125
PC:M103
Sq Ft: 5.66
6"D
6"H

#1293
PC:M103
Sq Ft: 6.01
5²³/₃₂"D
6³¹/₃₂"H

#2229
PC: M103
Sq Ft: 1.92
2¹³/₃₂"D
1²⁵/₃₂"H

FRC = Fastener Relief Cut.

= Available for Convex/Concave products.

★ = Available with 3D Laminate/RTF.

► For PRICING ► See Section N.1 in our current Wholesale Pricing Catalog.

Crown Moldings to Accept Additional Insert

#2160
PC: M105
Sq Ft: 2.00
1 3/4"D
3"H

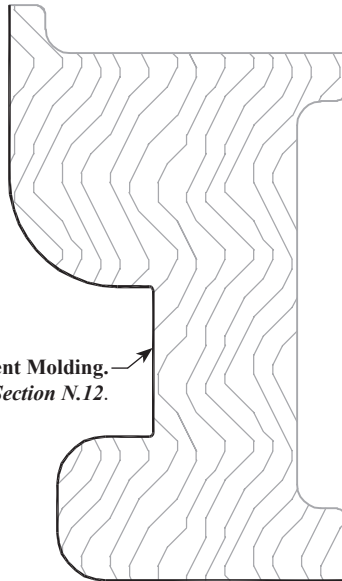

#2697
PC: M101
Sq Ft: 1.82
1 5/16"D
1 5/16"H

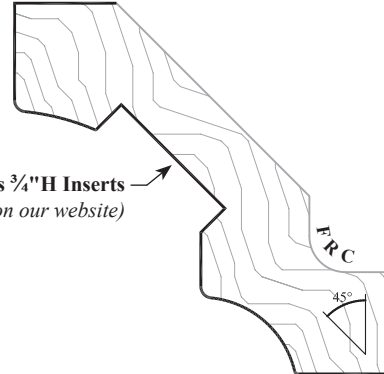

#2599
PC: M101
Sq Ft: 2.94
3"D
3"H



Accepts 3/4"H Accent Molding.
See Notes in Section N.12.

Accepts 3/4"H Inserts
(Search "Insert Moldings" on our website)

Accepts 2 1/4"H Inserts
(Search "Insert Moldings" on our website)

Mounting Plates

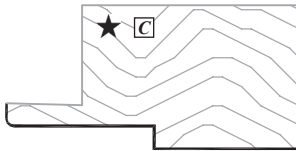

#864
PC: M101
Sq Ft: 1.01
1 17/32"D
3/4"H

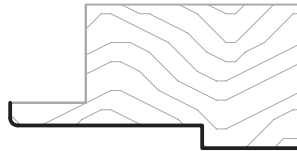

#3127
PC: M101
Sq Ft: 1.01
1 17/32"D
3/4"H

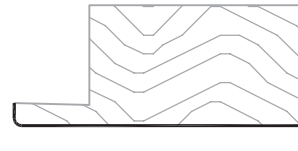

#1742
PC: M101
Sq Ft: 1.01
1 17/32"D
5/8"H



#2214
PC: M101
Sq Ft: 1.00
1 1/2"D
5/8"H

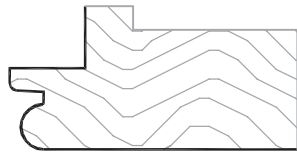

#2236
PC: M101
Sq Ft: 1.00
1 1/2"D
3/4"H

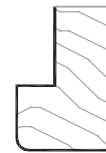

#1893
PC: M101
Sq Ft: .72
1/2"D
3/4"H

FRC = Fastener Relief Cut.

☐ = Available for Convex/Concave products.

★ = Available with 3D Laminate/RTF.

► For PRICING ► See Section N.1 in our current Wholesale Pricing Catalog.

Crown Molding and Crown Molding Assemblies (using mounting plates)

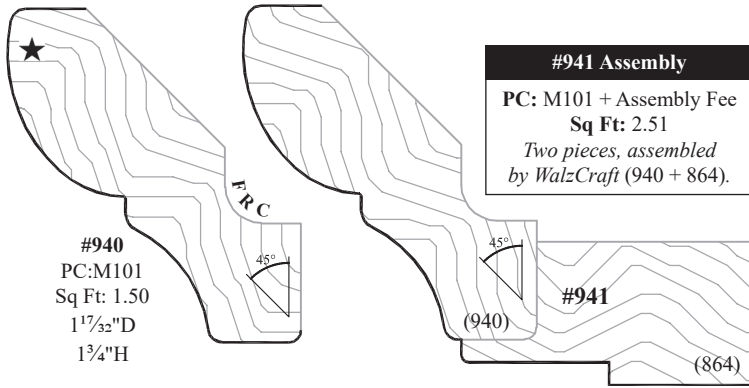

#941 Assembly
 PC: M101 + Assembly Fee
Sq Ft: 2.51
*Two pieces, assembled
 by WalzCraft (940 + 864).*

#940
 PC:M101
 Sq Ft: 1.50
 1¹⁷/₃₂"D
 1³/₄"H

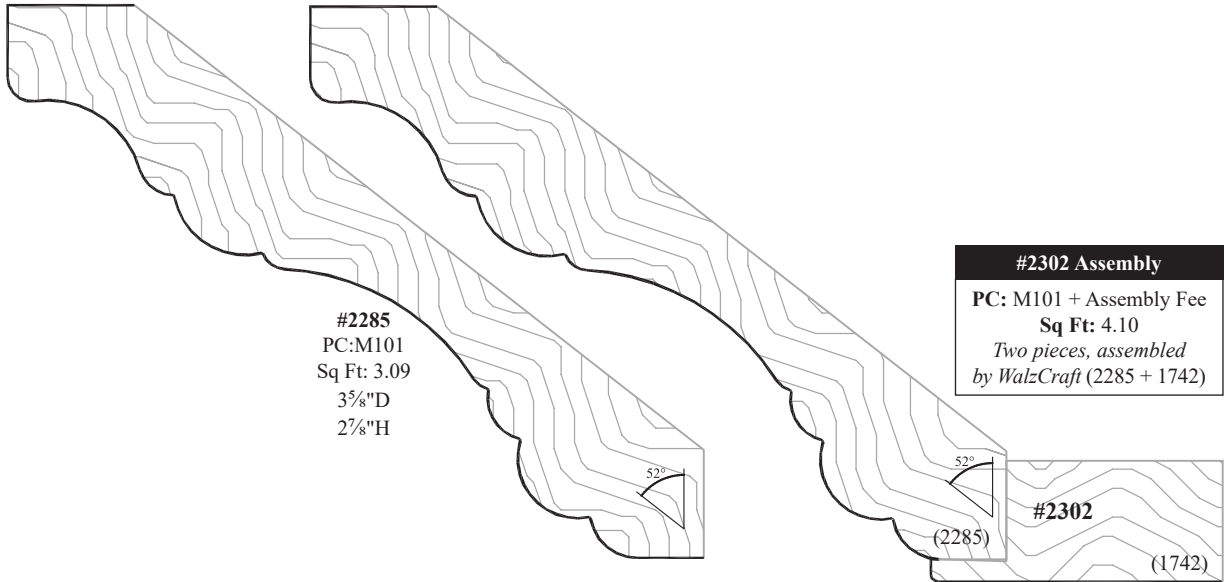

#2302 Assembly
 PC: M101 + Assembly Fee
Sq Ft: 4.10
*Two pieces, assembled
 by WalzCraft (2285 + 1742)*

#2285
 PC:M101
 Sq Ft: 3.09
 3⁵/₈"D
 2⁷/₈"H

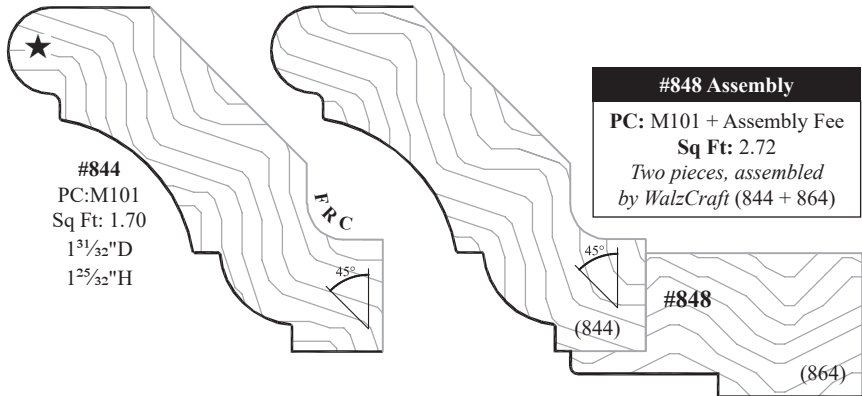

#848 Assembly
 PC: M101 + Assembly Fee
Sq Ft: 2.72
*Two pieces, assembled
 by WalzCraft (844 + 864)*

#844
 PC:M101
 Sq Ft: 1.70
 1³¹/₃₂"D
 1²⁵/₃₂"H

FRC = Fastener Relief Cut. **C** = Available for Convex/Concave products. ★ = Available with 3D Laminate/RTF.

► For PRICING ► See Section N.1 in our current Wholesale Pricing Catalog.

Crown Molding and Crown Molding Assemblies (using mounting plates)

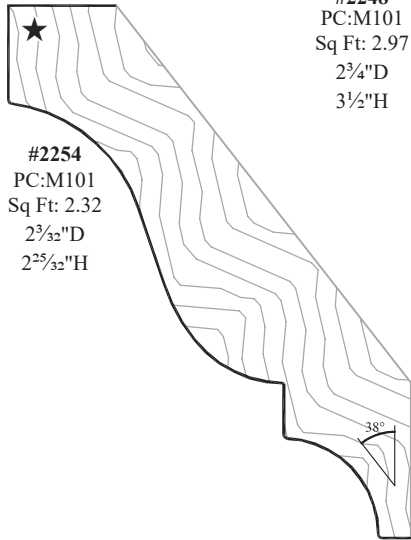

#2254
PC:M101
Sq Ft: 2.32
2³/₃₂"D
2²⁵/₃₂"H

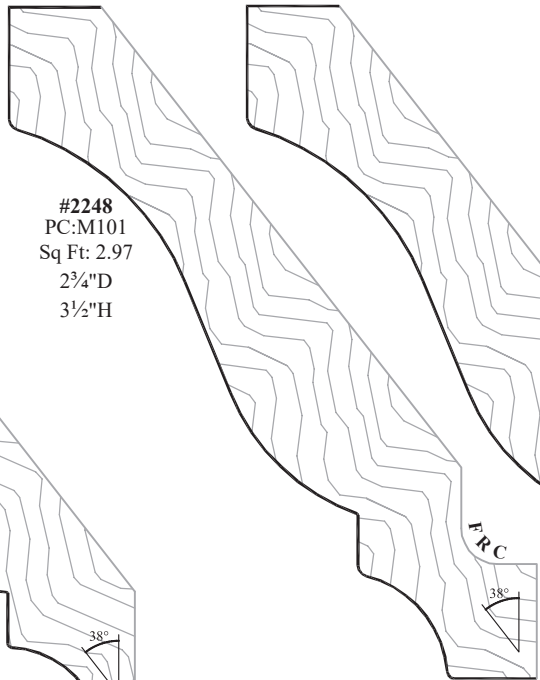

#2248
PC:M101
Sq Ft: 2.97
2³/₄"D
3¹/₂"H

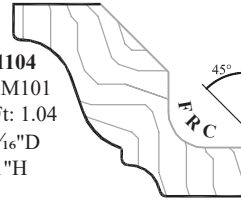

#1104
PC:M101
Sq Ft: 1.04
1³/₁₆"D
1"H

#2267 Assembly
PC: M101 + Assembly Fee
Sq Ft: 3.98
Two pieces, assembled by WalzCraft (2248 + 864).

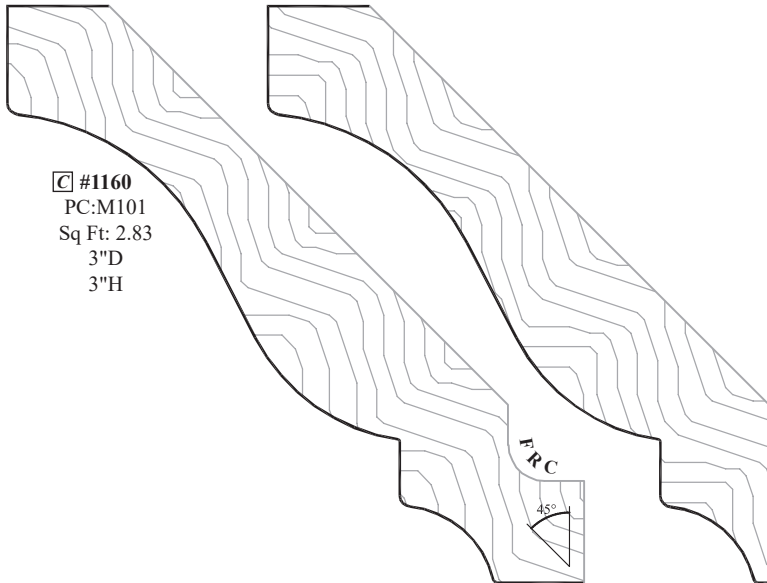
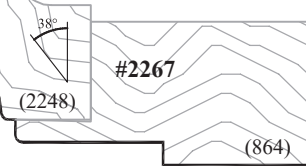

#1160
PC:M101
Sq Ft: 2.83
3"D
3"H

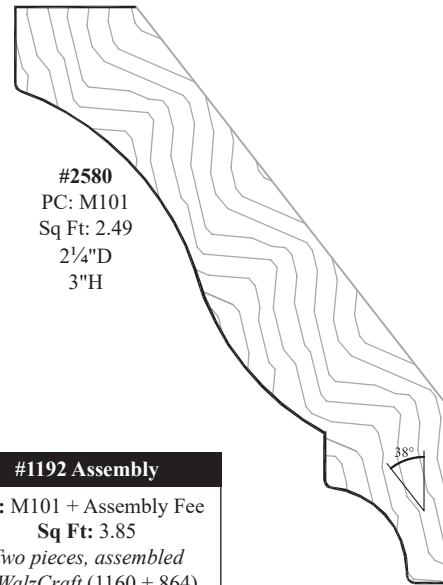

#2580
PC: M101
Sq Ft: 2.49
2¹/₄"D
3"H

#1192 Assembly
PC: M101 + Assembly Fee
Sq Ft: 3.85
Two pieces, assembled by WalzCraft (1160 + 864).

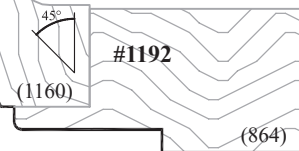

FRC = Fastener Relief Cut. □ = Available for Convex/Concave products. ★ = Available with 3D Laminate/RTF.

► For PRICING ► See Section N.1 in our current Wholesale Pricing Catalog.

Crown Molding and Crown Molding Assemblies (using mounting plates)

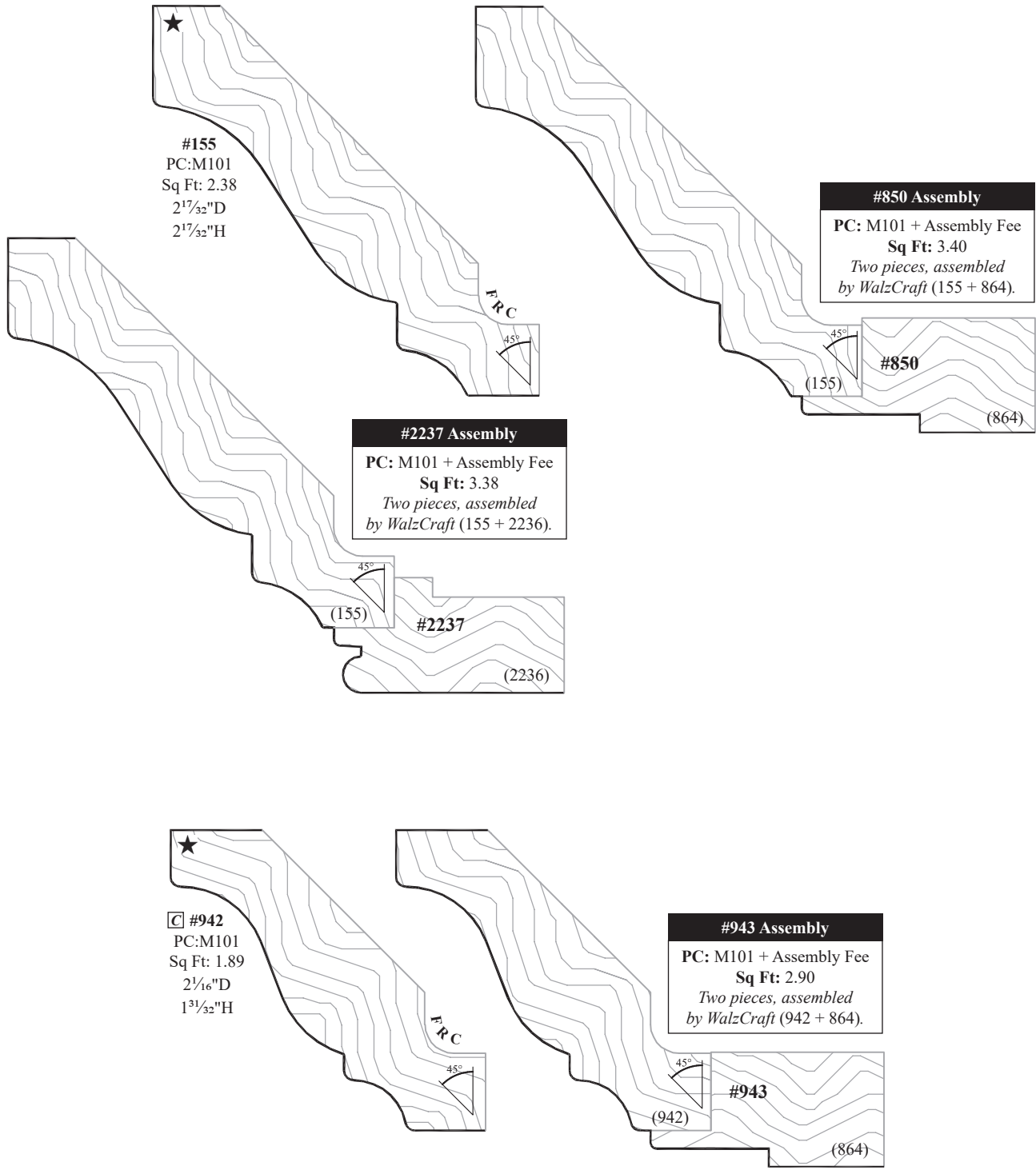

N

FRC = Fastener Relief Cut. [C] = Available for Convex/Concave products. ★ = Available with 3D Laminate/RTF.

► For PRICING ► See Section N.1 in our current Wholesale Pricing Catalog.

Crown Molding and Crown Molding Assemblies (using mounting plates)

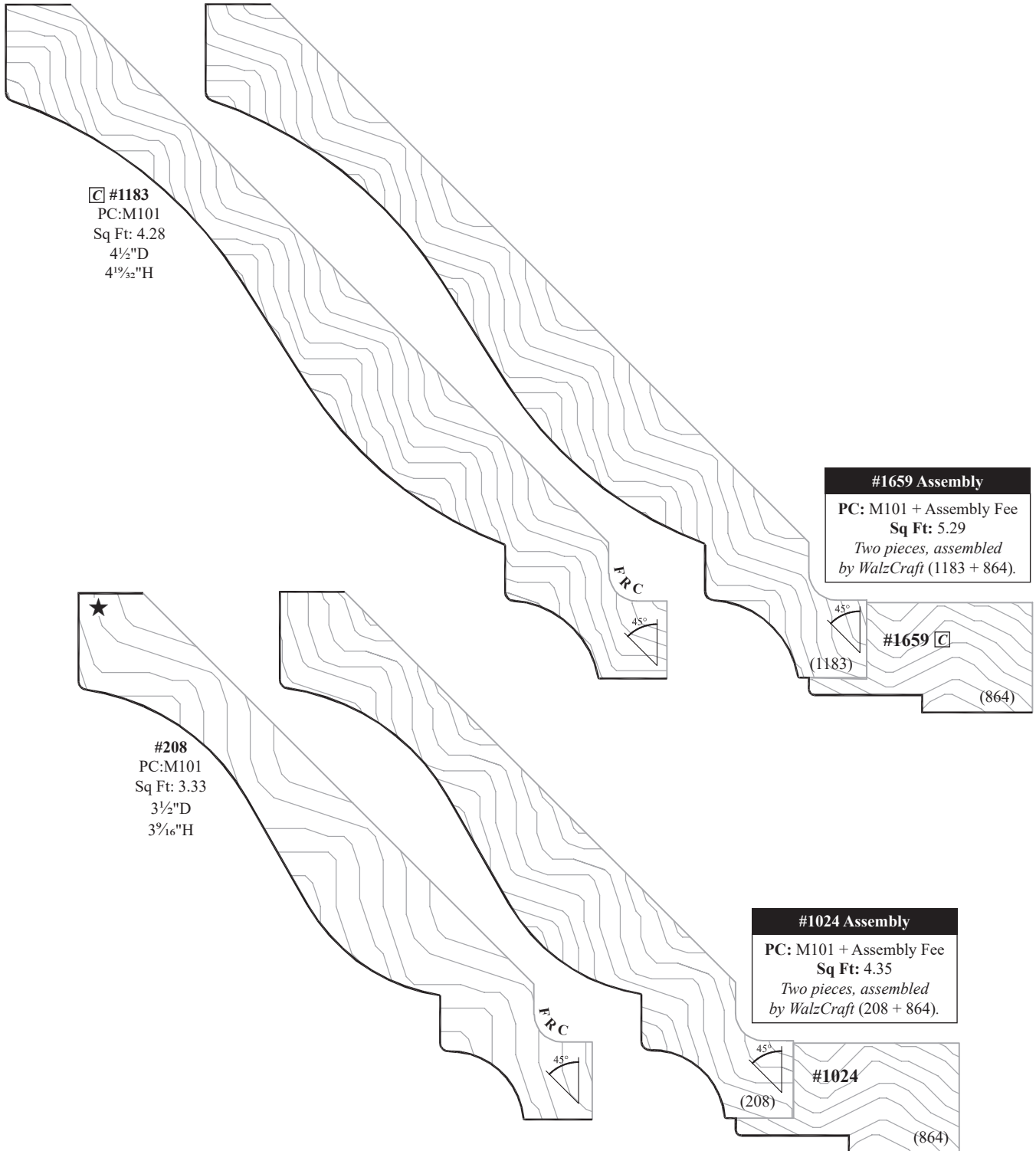

#1183
 PC:M101
 Sq Ft: 4.28
 4½"D
 4½"H

#1659 Assembly

PC: M101 + Assembly Fee
Sq Ft: 5.29
 Two pieces, assembled
 by WalzCraft (1183 + 864).

#208
 PC:M101
 Sq Ft: 3.33
 3½"D
 3¾"H

#1024 Assembly

PC: M101 + Assembly Fee
Sq Ft: 4.35
 Two pieces, assembled
 by WalzCraft (208 + 864).

FRC = Fastener Relief Cut. **C** = Available for Convex/Concave products. ★ = Available with 3D Laminate/RTF.

► **For PRICING** ► See Section N.1 in our current Wholesale Pricing Catalog.

Crown Molding and Crown Molding Assemblies (using mounting plates)

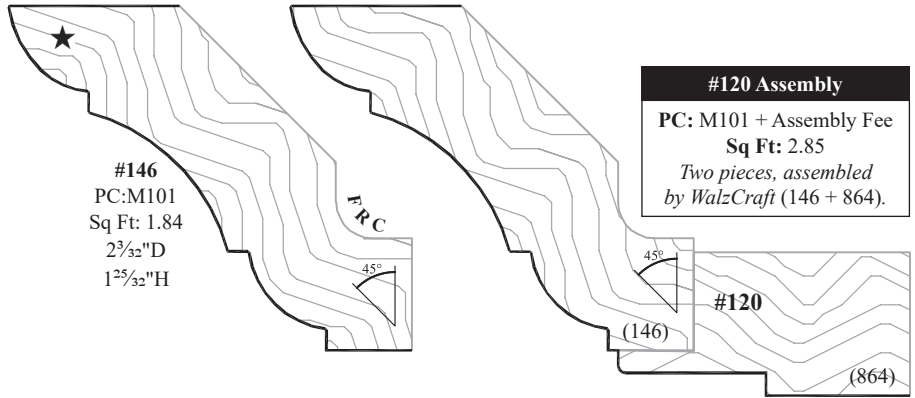

#146
PC:M101
Sq Ft: 1.84
2³/₃₂"D
1²⁵/₃₂"H

#120 Assembly
PC: M101 + Assembly Fee
Sq Ft: 2.85
*Two pieces, assembled
by WalzCraft (146 + 864).*

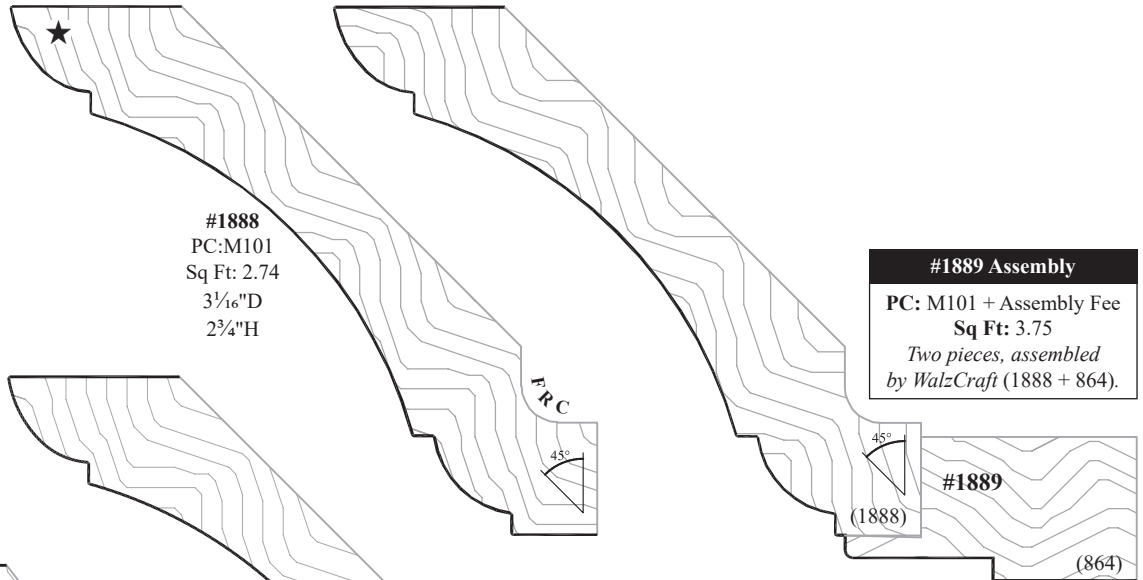

#1888
PC:M101
Sq Ft: 2.74
3¹/₁₆"D
2³/₄"H

#1889 Assembly
PC: M101 + Assembly Fee
Sq Ft: 3.75
*Two pieces, assembled
by WalzCraft (1888 + 864).*

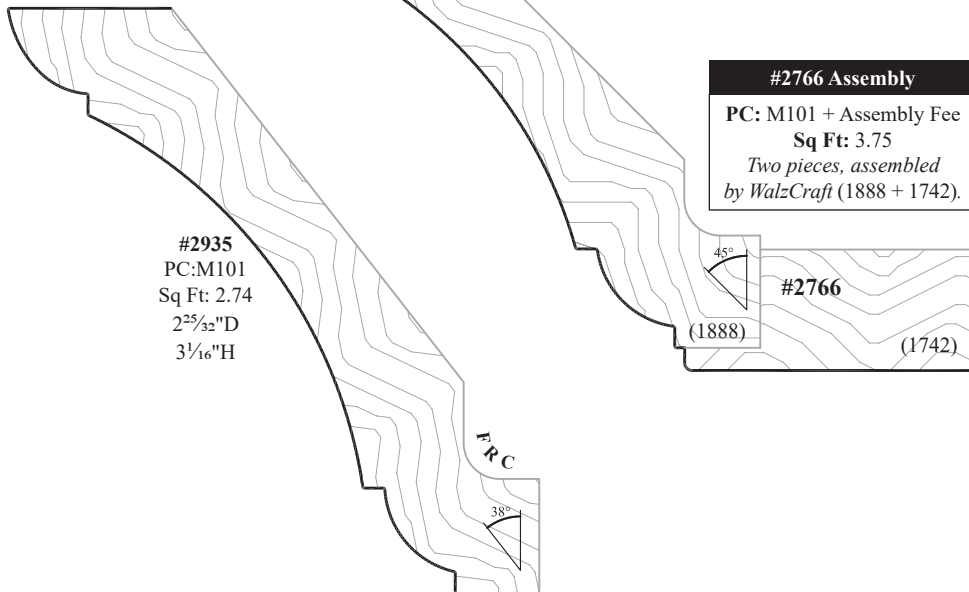

#2935
PC:M101
Sq Ft: 2.74
2²⁵/₃₂"D
3¹/₁₆"H

#2766 Assembly
PC: M101 + Assembly Fee
Sq Ft: 3.75
*Two pieces, assembled
by WalzCraft (1888 + 1742).*

FRC = Fastener Relief Cut. ☐ = Available for Convex/Concave products. ★ = Available with 3D Laminate/RTF.

► For PRICING ► See Section N.1 in our current Wholesale Pricing Catalog.

Crown Molding and Crown Molding Assemblies (using mounting plates)

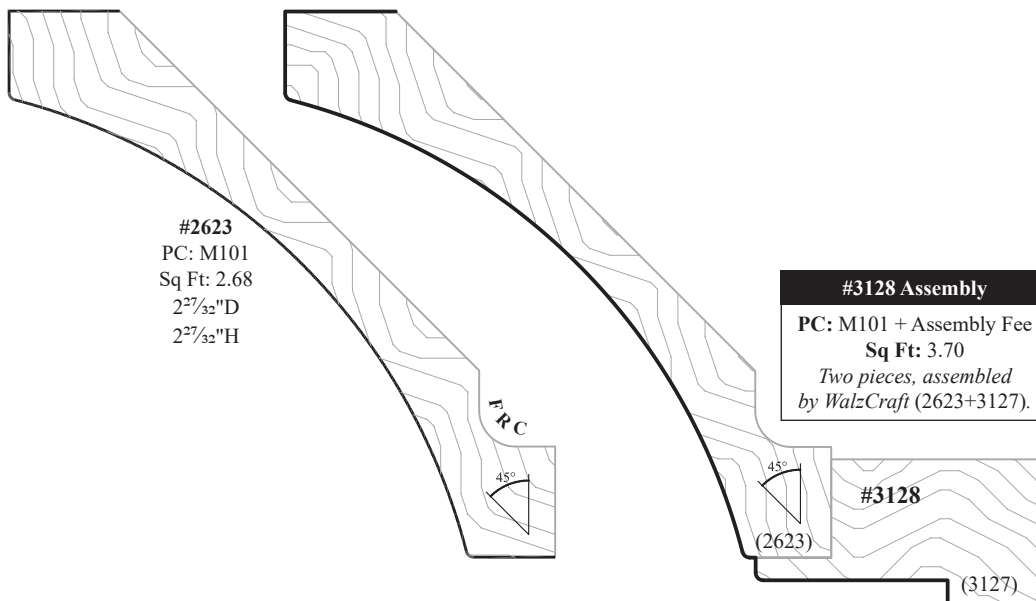
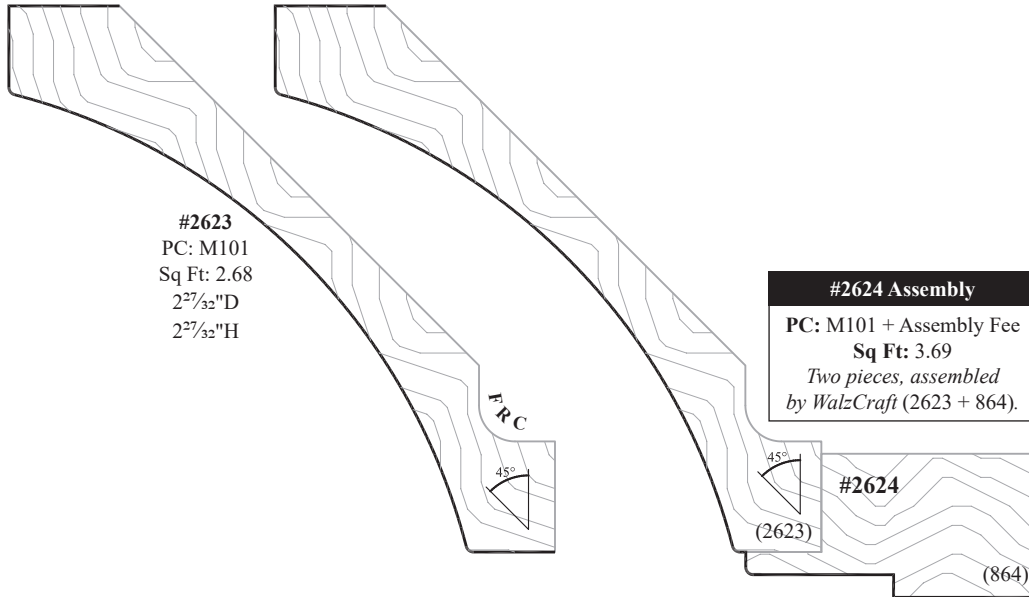

FRC = Fastener Relief Cut. [C] = Available for Convex/Concave products. ★ = Available with 3D Laminate/RTF.

► For PRICING ► See Section N.1 in our current Wholesale Pricing Catalog.

Crown Molding and Crown Molding Assemblies (using mounting plates)

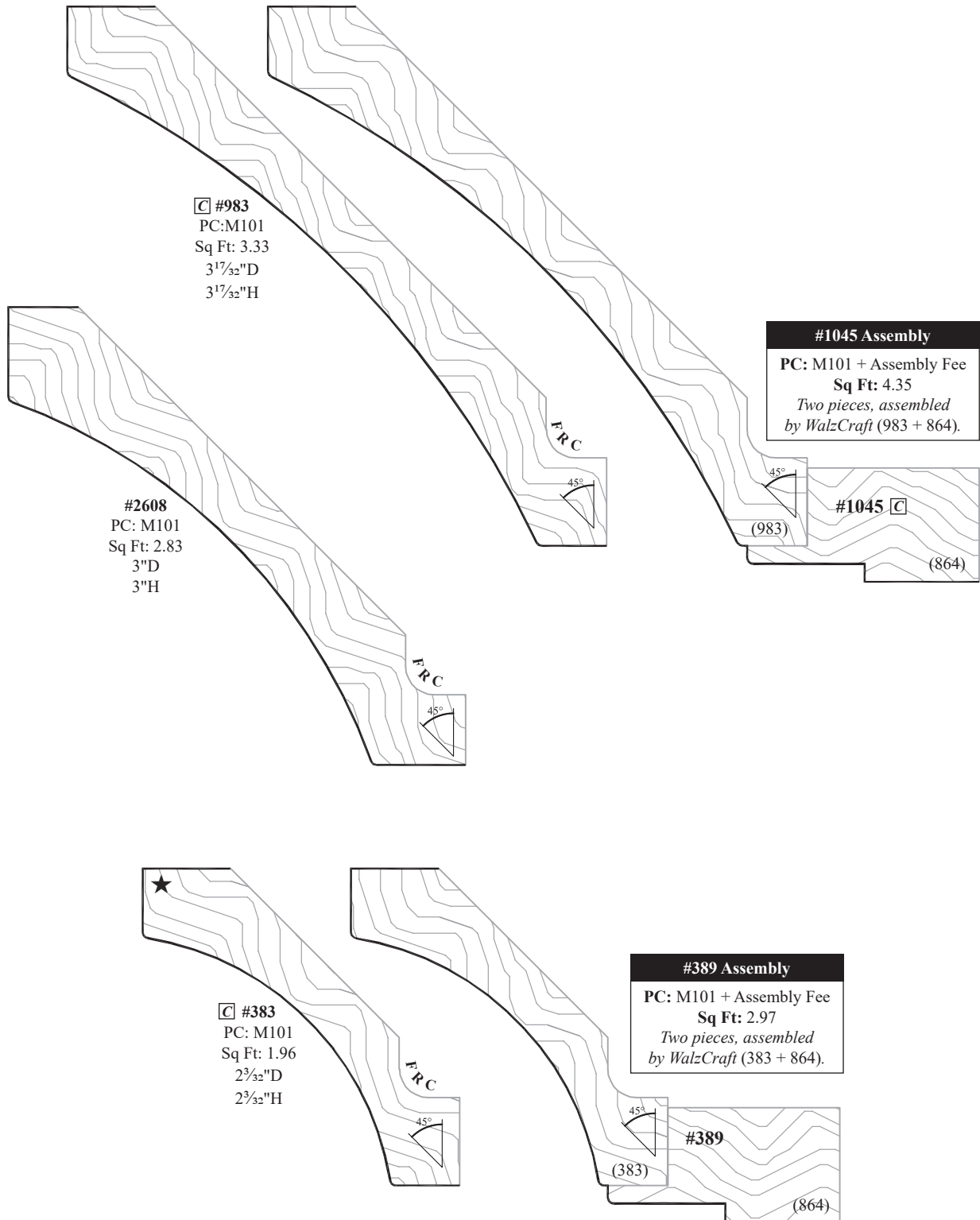

N

FRC = Fastener Relief Cut.

☐ = Available for Convex/Concave products.

★ = Available with 3D Laminate/RTF.

► For PRICING ► See Section N.1 in our current Wholesale Pricing Catalog.

Crown Molding and Crown Molding Assemblies (using mounting plates)

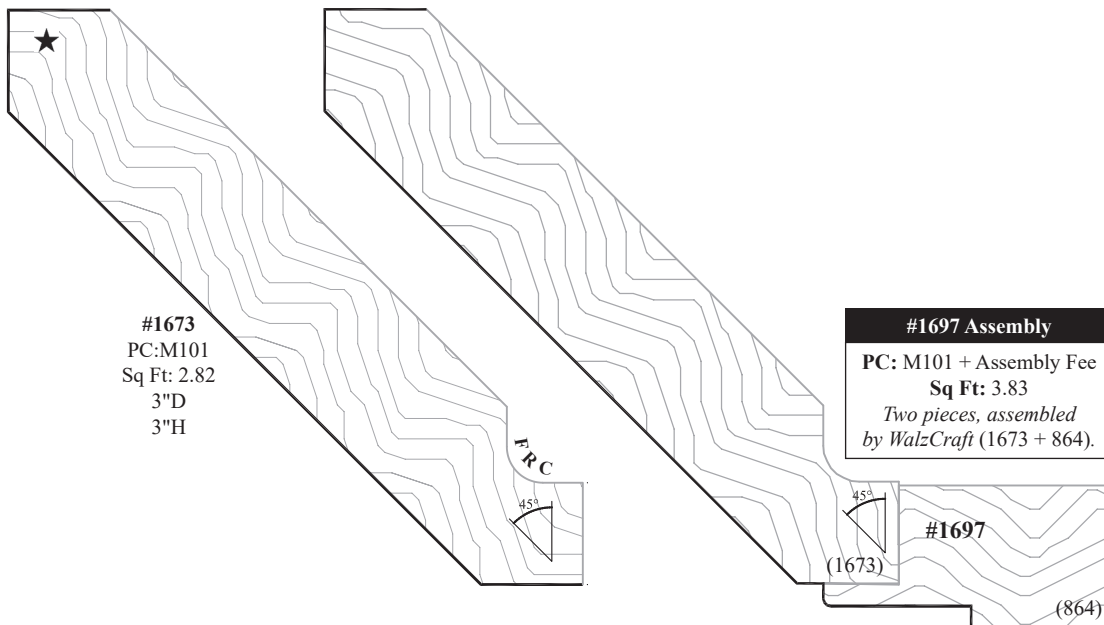
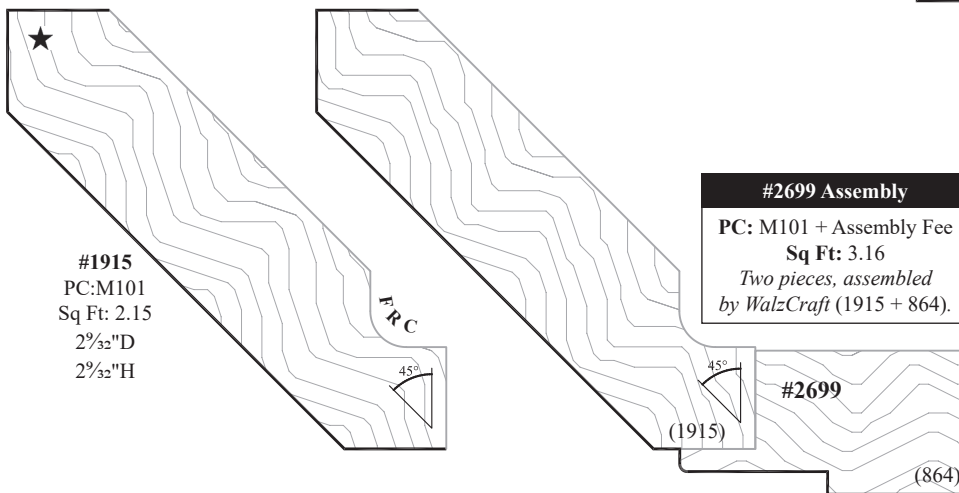
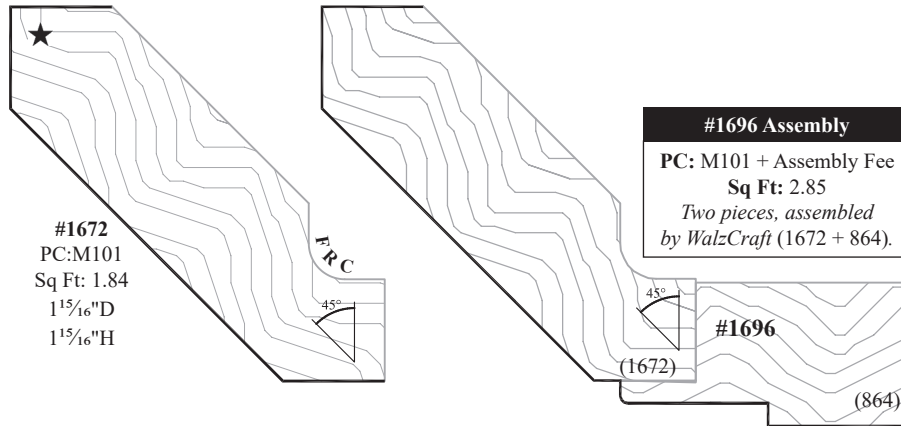

FRC = Fastener Relief Cut. [C] = Available for Convex/Concave products. ★ = Available with 3D Laminate/RTF.

► For PRICING ► See Section N.1 in our current Wholesale Pricing Catalog.

Crown Molding and Crown Molding Assemblies (using mounting plates)

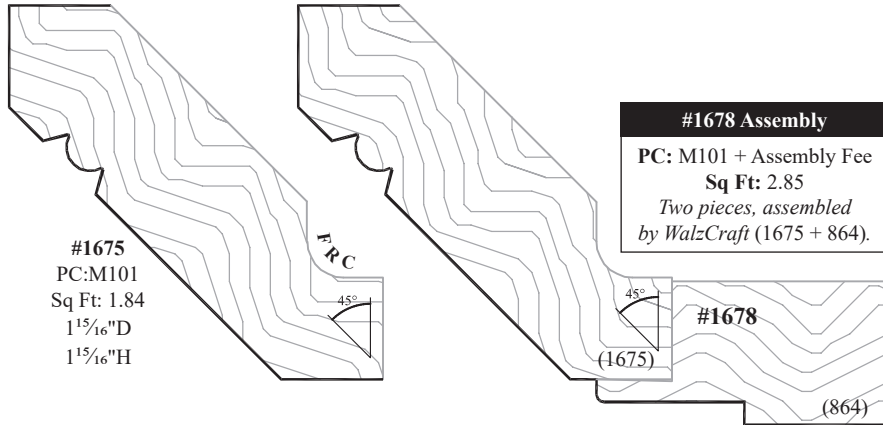

#1675
PC:M101
Sq Ft: 1.84
1¹⁵/₁₆"D
1¹⁵/₁₆"H

#1678 Assembly
PC: M101 + Assembly Fee
Sq Ft: 2.85
*Two pieces, assembled
by WalzCraft (1675 + 864).*

#1678

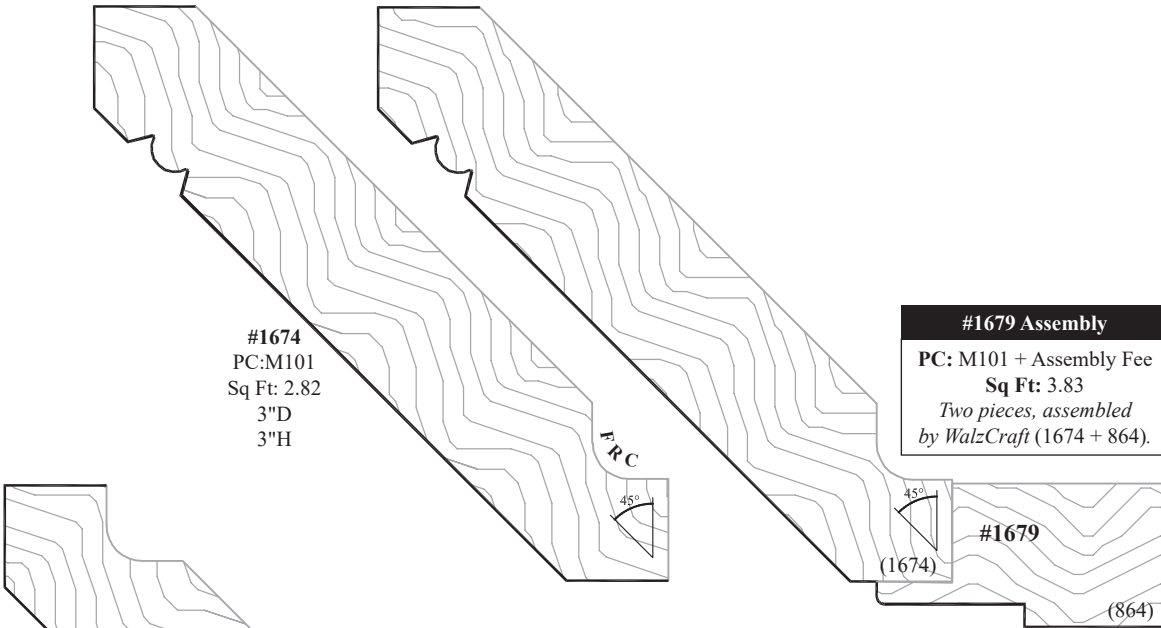

#1674
PC:M101
Sq Ft: 2.82
3"D
3"H

#1679 Assembly
PC: M101 + Assembly Fee
Sq Ft: 3.83
*Two pieces, assembled
by WalzCraft (1674 + 864).*

#1679

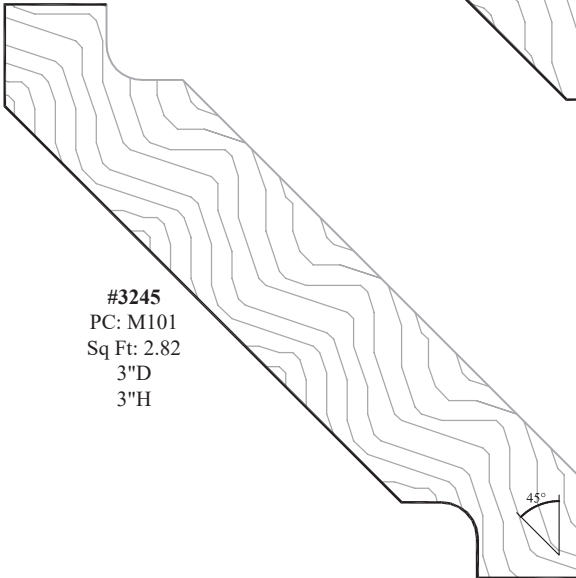

#3245
PC: M101
Sq Ft: 2.82
3"D
3"H

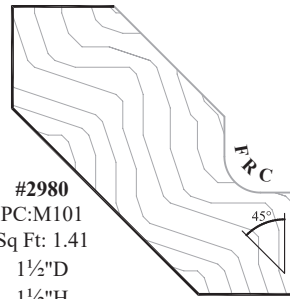

#2980
PC:M101
Sq Ft: 1.41
1¹/₂"D
1¹/₂"H

FRC = Fastener Relief Cut.

C = Available for Convex/Concave products.

★ = Available with 3D Laminate/RTF.

► For PRICING ► See Section [N.1](#) in our current Wholesale Pricing Catalog.

Crown Molding and Crown Molding Assemblies (using mounting plates)

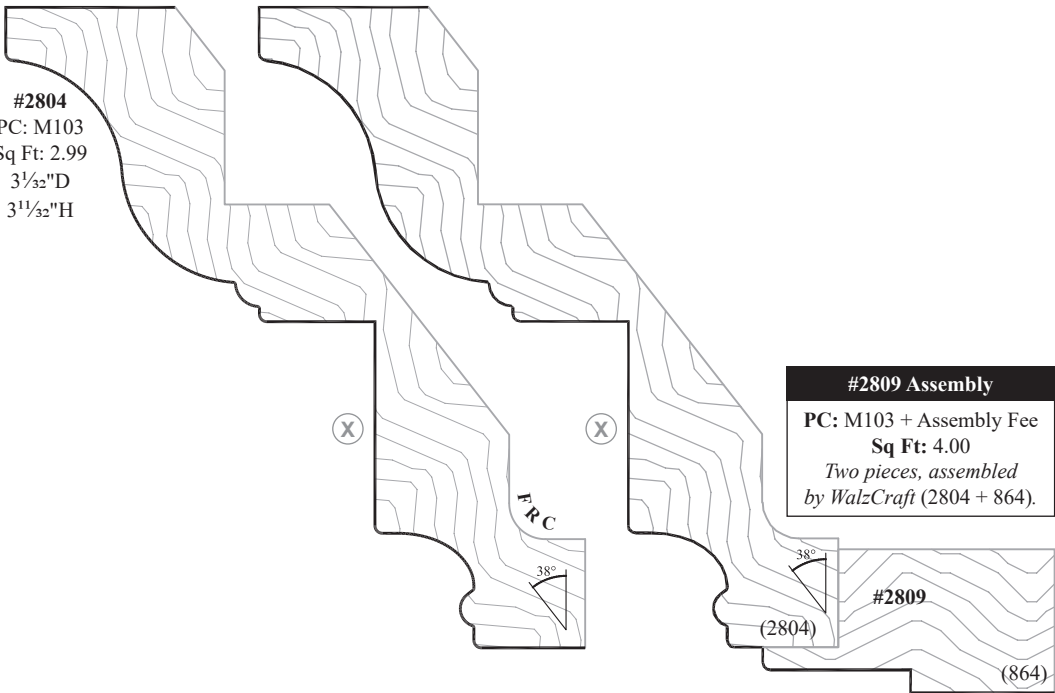
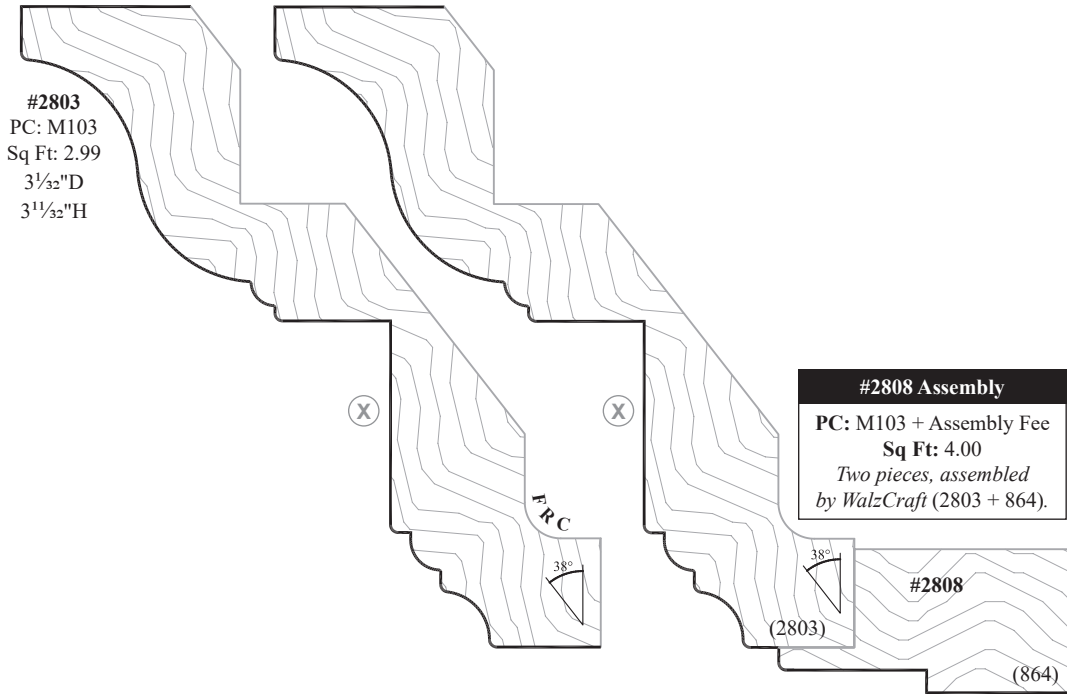

FRC = Fastener Relief Cut. [C] = Available for Convex/Concave products. ★ = Available with 3D Laminate/RTF.

► For PRICING ► See Section N.1 in our current Wholesale Pricing Catalog.

Crown Molding and Crown Molding Assemblies (using mounting plates)

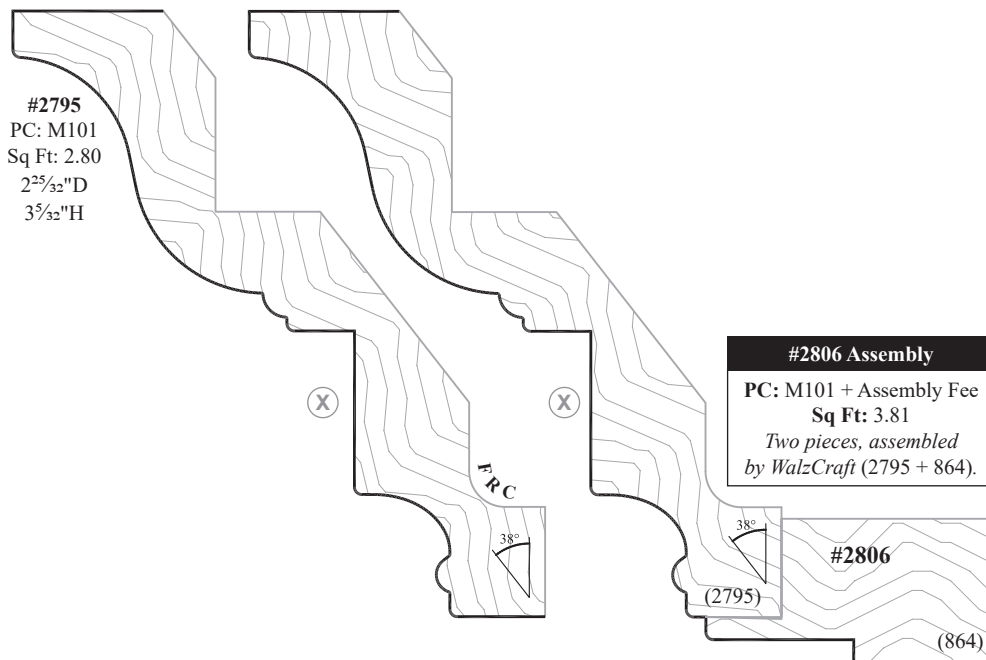
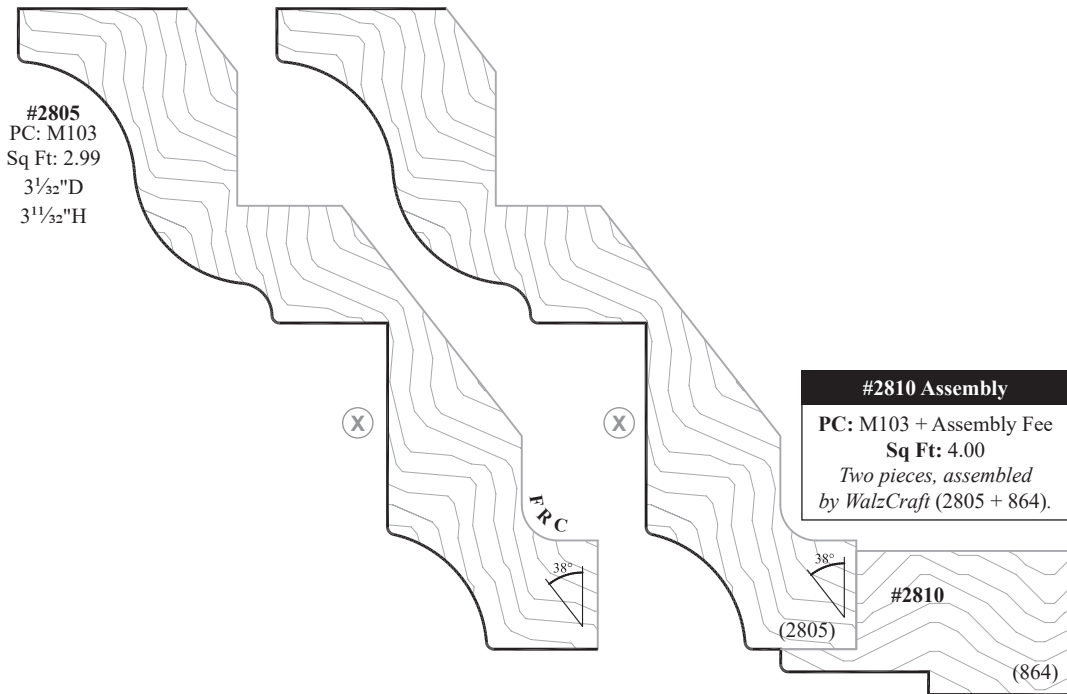

FRC = Fastener Relief Cut.

[C] = Available for Convex/Concave products.

★ = Available with 3D Laminate/RTF.

► For PRICING ► See Section N.1 in our current Wholesale Pricing Catalog.

N

Crown Molding and Crown Molding Assemblies (using mounting plates)

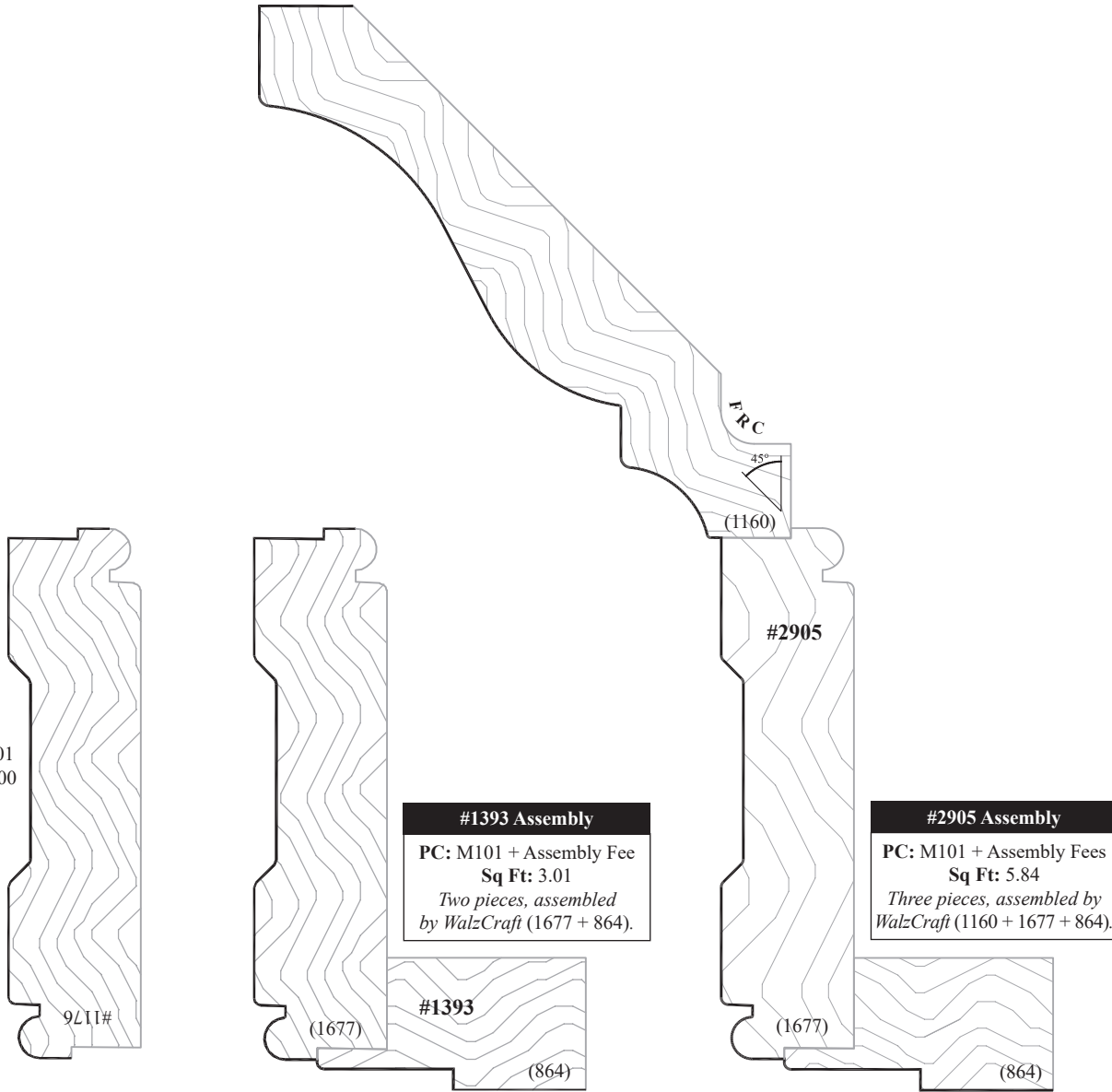

FRC = Fastener Relief Cut.

C = Available for Convex/Concave products.

★ = Available with 3D Laminate/RTF.

► For PRICING ► See Section N.1 in our current Wholesale Pricing Catalog.

Crown Molding and Crown Molding Assemblies (using mounting plates)

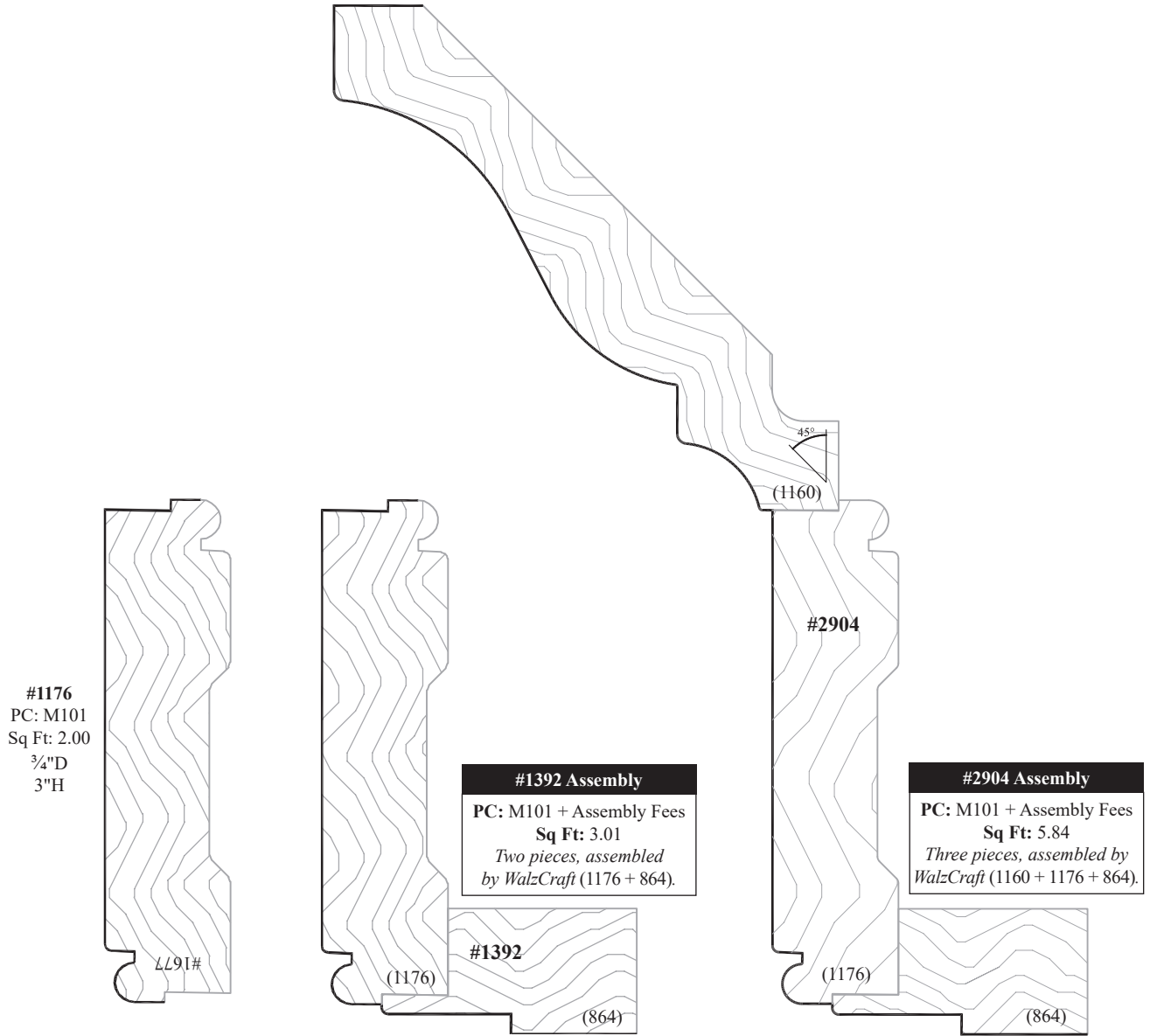

FRC = Fastener Relief Cut.

[C] = Available for Convex/Concave products.

★ = Available with 3D Laminate/RTF.

► For PRICING ► See Section N.1 in our current Wholesale Pricing Catalog.

Crown Molding and Crown Molding Assemblies (using mounting plates)

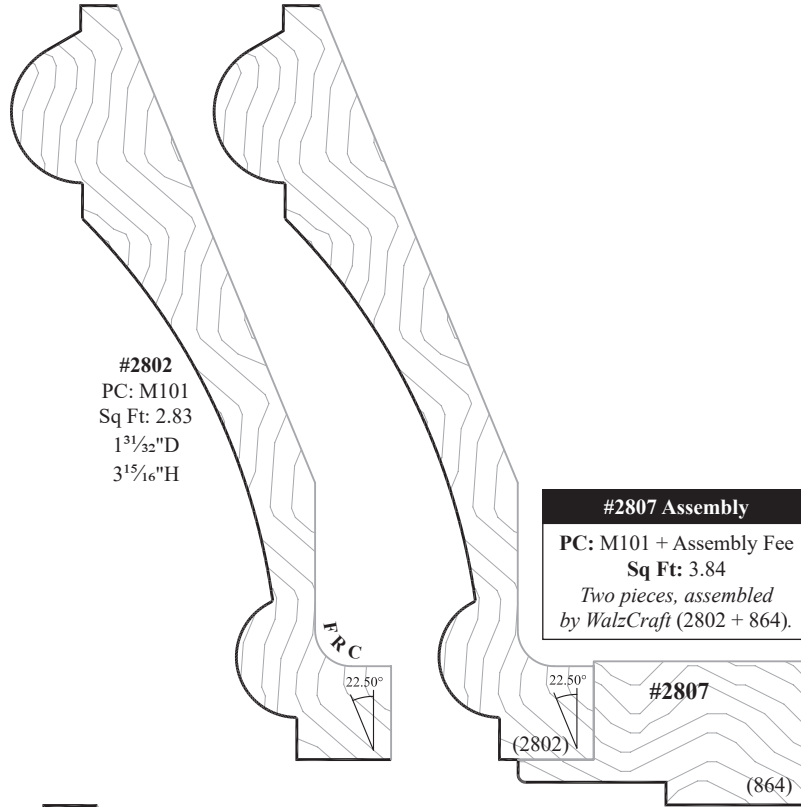

#2802
 PC: M101
 Sq Ft: 2.83
 1³¹/₃₂"D
 3¹⁵/₁₆"H

#2807 Assembly

PC: M101 + Assembly Fee
Sq Ft: 3.84
 Two pieces, assembled
 by WalzCraft (2802 + 864).

#2807

(2802)

(864)

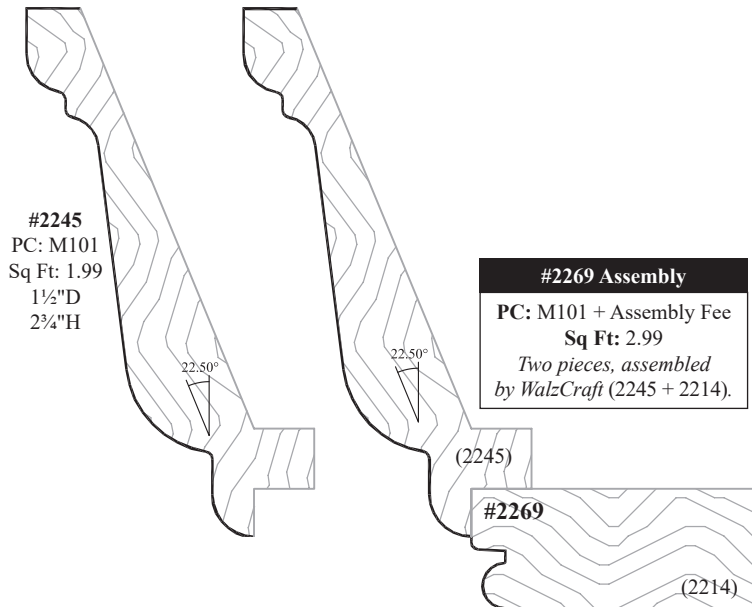

#2245
 PC: M101
 Sq Ft: 1.99
 1¹/₂"D
 2³/₄"H

#2269 Assembly

PC: M101 + Assembly Fee
Sq Ft: 2.99
 Two pieces, assembled
 by WalzCraft (2245 + 2214).

#2269

(2245)

(2214)

FRC = Fastener Relief Cut.

C = Available for Convex/Concave products.

★ = Available with 3D Laminate/RTF.

► For PRICING ► See Section N.1 in our current Wholesale Pricing Catalog.

Crown Molding Back-Up Blocks

These crown molding back-up blocks allow you to perfectly position your crown molding and speed up the installation process. Back-up block moldings #2318, #2585, #2586 and #2629 work with any crown molding that has either a 22.5°, 38° or 45° spring angle and our Fastener Relief Cut (FRC). Crown molding and back-up block sold separately.

#2318
PC: M101
Sq Ft: 1.33
2"D
¾"H



#2585
PC: M101
Sq Ft: 1.33
2"D
¾"H

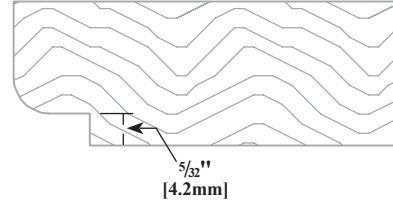

#2586
PC: M101
Sq Ft: 1.33
2"D
¾"H

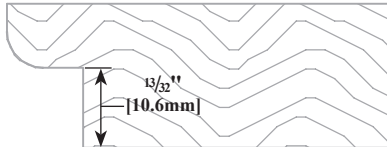

#2629
PC: M101
Sq Ft: 1.33
2"D
¾"H

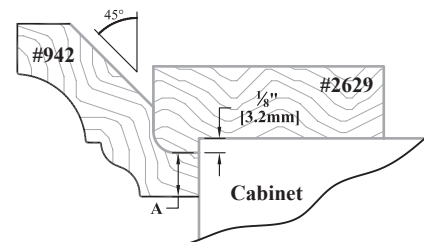
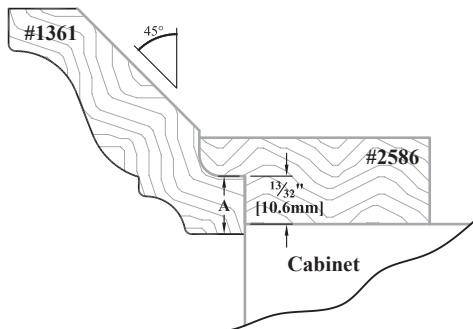
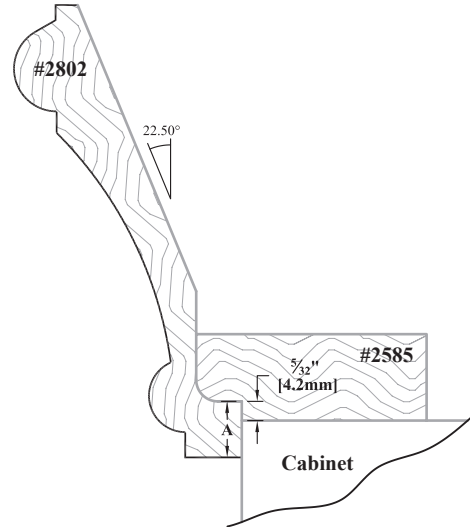
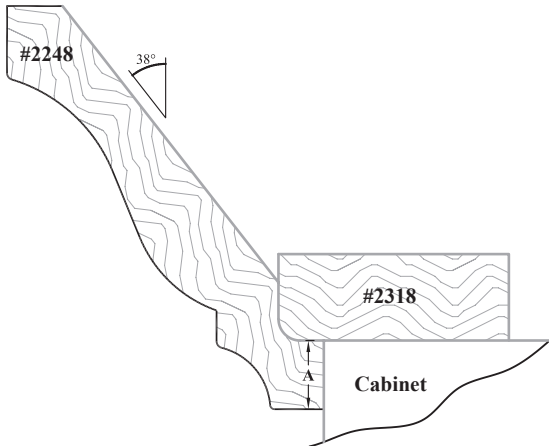
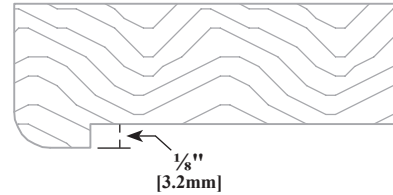

Note: Dimension (A) varies. See individual crown moldings. Applications drawings not shown at full scale.

FRC = Fastener Relief Cut.

☐ = Available for Convex/Concave products.

★ = Available with 3D Laminate/RTF.

► For PRICING ► See Section [N.1](#) in our current Wholesale Pricing Catalog.

Straight Molding and Straight Molding Assembly

Adding an Outside Edge Profile: Molding #1702 and Straight Crown Assembly #1703 are available with most outside edge profiles. This particular drawing demonstrates the use of a **D17** edge profile, it *does not* automatically come with the **D17**.

- When ordering, please specify the **Outside Edge Profile** or denote **D7** if you prefer that it be left square.
- See our website under Technical Information for compatibility.

#1702
PC:M101
Sq Ft: 2.99
¾"D
4½"H

#1703 Assembly
PC: M101 + Assembly Fee
Sq Ft: 4.49
Two pieces, assembled
by WalzCraft (1702 + 1701).

#1703

(1702)

(1701)

D17
OSE

#1701
PC:M101
Sq Ft: 1.50
2¼"D
¾"H

D7
OSE

Additional Outside Edge Profile Examples

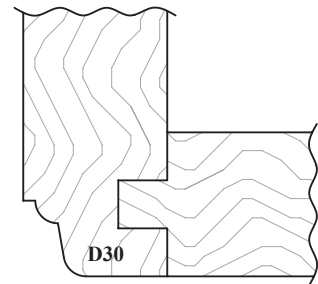
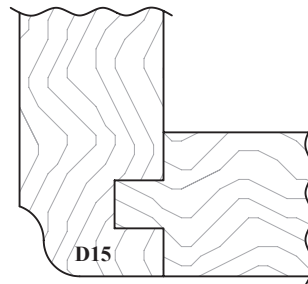
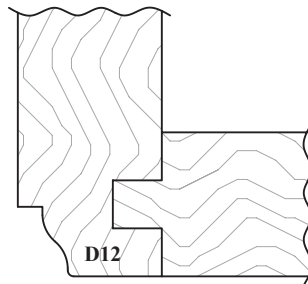
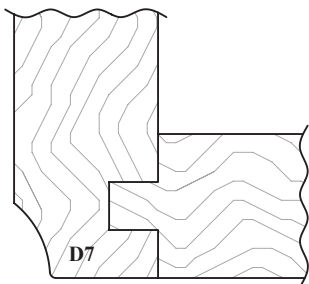

FRC = Fastener Relief Cut.

☐ = Available for Convex/Concave products.

★ = Available with 3D Laminate/RTF.

► For PRICING ► See Section N.1 in our current Wholesale Pricing Catalog.

Combining Moldings

Combining Moldings: Many moldings throughout *Chapter N* can be combined or "stacked" to create your own unique look. Below are just two examples. In each example, three moldings were brought together to create a truly custom look..

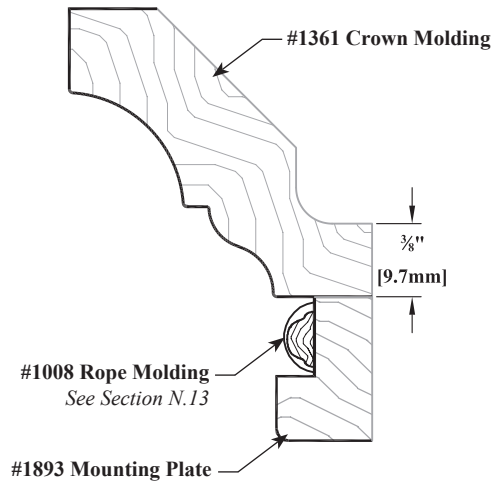
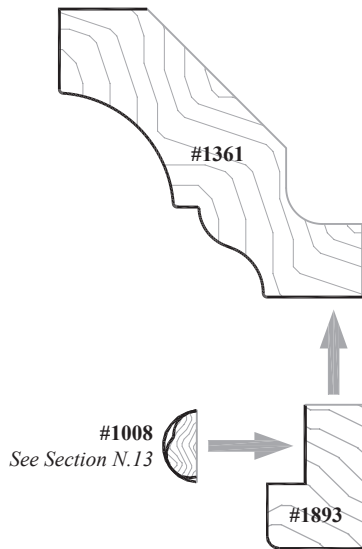
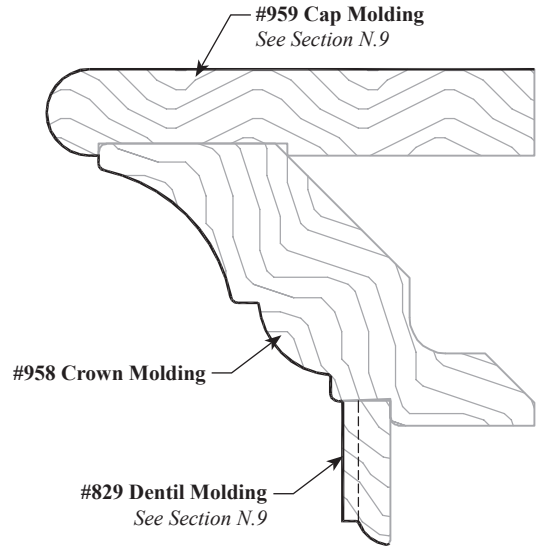
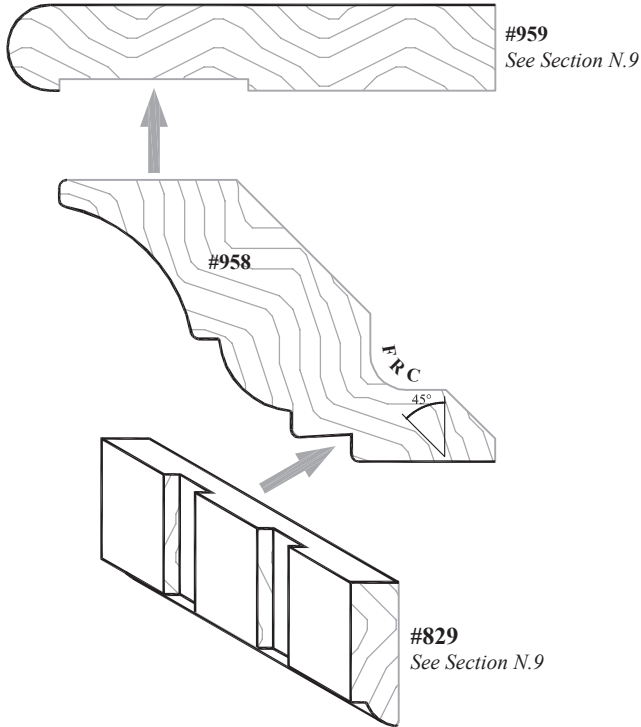

FRC = Fastener Relief Cut.

[C] = Available for Convex/Concave products.

★ = Available with 3D Laminate/RTF.

► For PRICING ► See Section N.1 in our current Wholesale Pricing Catalog.

Molding Options

Refacing Molding

1/8" Face/Scribe Refacing Molding

Drawing not to Scale

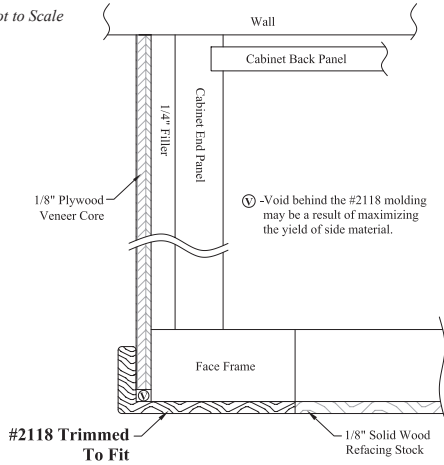

Molding #	Dimension A	Dimension B	Price Class	Square Foot
2115	1 3/16" [30.2mm]	1" [25.4mm]	M101	.79
2331	1 3/16" [33.3mm]	1 1/8" [28.6mm]	M101	.88
2116	1 7/16" [36.5mm]	1 1/4" [31.8mm]	M101	.96
2332	1 9/16" [39.7mm]	1 3/8" [34.9mm]	M101	1.04
2117	1 11/16" [42.9mm]	1 1/2" [38.1mm]	M101	1.13
2333	1 13/16" [46.0mm]	1 5/8" [41.3mm]	M101	1.21
2118	1 15/16" [49.2mm]	1 3/4" [44.5mm]	M101	1.29
2334	2 1/16" [52.4mm]	1 7/8" [47.6mm]	M101	1.38
2119	2 3/16" [55.6mm]	2" [50.8mm]	M101	1.46
2335	2 5/16" [58.7mm]	2 1/8" [54.0mm]	M101	1.54
2166	2 7/16" [61.9mm]	2 1/4" [57.2mm]	M101	1.63
2336	2 9/16" [65.1mm]	2 3/8" [60.3mm]	M101	1.71
2120	2 11/16" [68.3mm]	2 1/2" [63.5mm]	M101	1.79
2337	2 13/16" [71.4mm]	2 5/8" [66.7mm]	M101	1.88
2167	2 15/16" [74.6mm]	2 3/4" [70.0mm]	M101	1.96
2338	3 1/16" [77.8mm]	2 7/8" [73.0mm]	M101	2.04
2168	3 3/16" [81.0mm]	3" [76.2mm]	M101	2.13
2339	3 5/16" [84.1mm]	3 1/8" [79.4mm]	M101	2.21
2169	3 7/16" [87.3mm]	3 1/4" [82.6mm]	M101	2.29
2340	3 9/16" [90.5mm]	3 3/8" [85.7mm]	M101	2.38
2341	3 11/16" [93.7mm]	3 1/2" [88.9mm]	M101	2.46

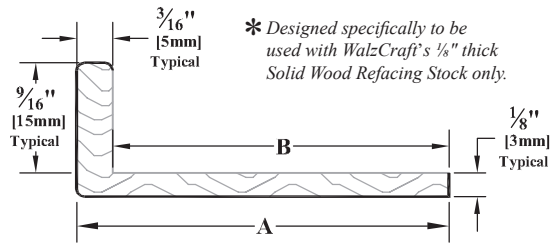

3/16" Face/Scribe Refacing Molding

Drawing not to Scale

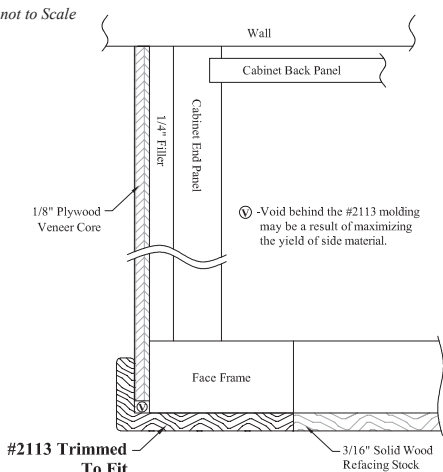

Molding #	Dimension A	Dimension B	Price Class	Square Foot
2145	1 3/16" [30.2mm]	1" [25.4mm]	M101	.79
2342	1 3/16" [33.3mm]	1 1/8" [28.6mm]	M101	.88
2111	1 7/16" [36.5mm]	1 1/4" [31.8mm]	M101	.96
2343	1 9/16" [39.7mm]	1 3/8" [34.9mm]	M101	1.04
2142	1 11/16" [42.9mm]	1 1/2" [38.1mm]	M101	1.13
2344	1 13/16" [46.0mm]	1 5/8" [41.3mm]	M101	1.21
2113	1 15/16" [49.2mm]	1 3/4" [44.5mm]	M101	1.29
2968	2" [50.8mm]	1 13/16" [46.0mm]	M101	1.33
2345	2 1/16" [52.4mm]	1 7/8" [47.6mm]	M101	1.38
2114	2 3/16" [55.6mm]	2" [50.8mm]	M101	1.46
2346	2 5/16" [58.7mm]	2 1/8" [54.0mm]	M101	1.54
2162	2 7/16" [61.9mm]	2 1/4" [57.2mm]	M101	1.63
2347	2 9/16" [65.1mm]	2 3/8" [60.3mm]	M101	1.71
2143	2 11/16" [68.3mm]	2 1/2" [63.5mm]	M101	1.79
2348	2 13/16" [71.4mm]	2 5/8" [66.7mm]	M101	1.88
2163	2 15/16" [74.6mm]	2 3/4" [70.0mm]	M101	1.96
2349	3 1/16" [77.8mm]	2 7/8" [73.0mm]	M101	2.04
2164	3 3/16" [81.0mm]	3" [76.2mm]	M101	2.13
2350	3 5/16" [84.1mm]	3 1/8" [79.4mm]	M101	2.21
2165	3 7/16" [87.3mm]	3 1/4" [82.6mm]	M101	2.29
2351	3 9/16" [90.5mm]	3 3/8" [85.7mm]	M101	2.38
2352	3 11/16" [93.7mm]	3 1/2" [88.9mm]	M101	2.46

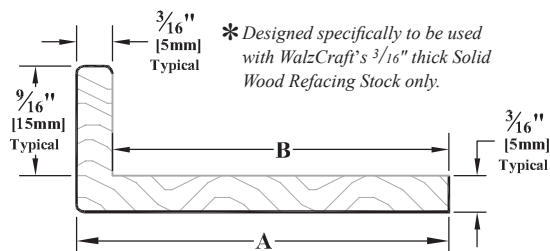

*We can control the finished thickness of the Refacing Moldings and Solid Wood Refacing Stock as they are produced in house. These moldings are not intended to be used with sheet stock (on face of cabinet), as plywood thicknesses are beyond our ability to control.

► For PRICING ► See Section N.2 in our current Wholesale Pricing Catalog.

Miscellaneous Face/Scribe Refacing Molding

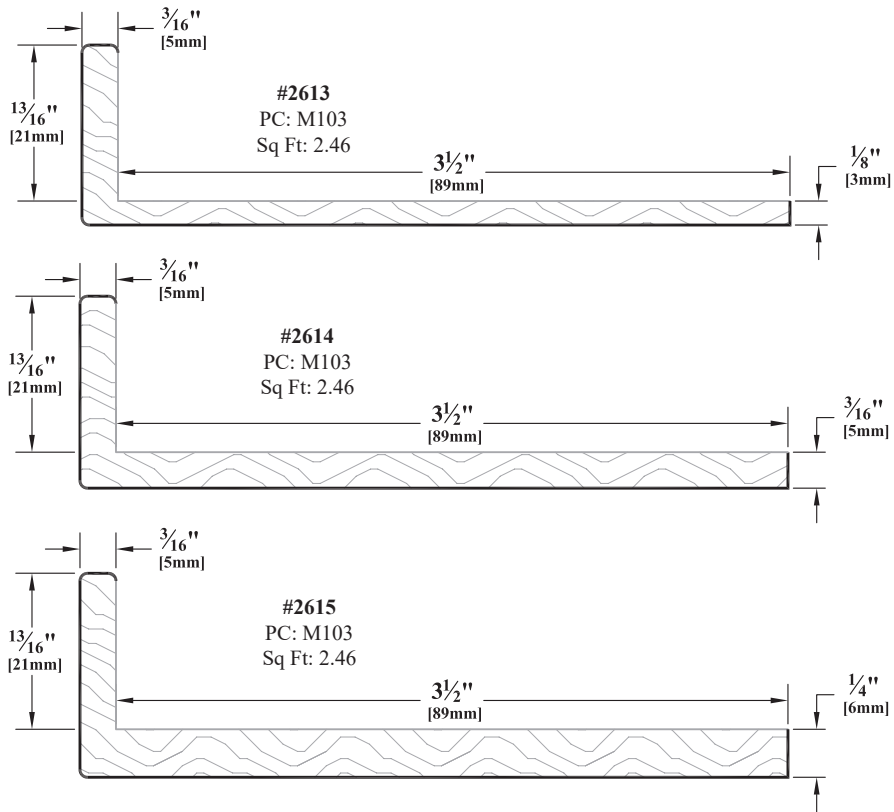

Scribe Refacing Molding

For 1/4" Plywood



#2353
PC: M102
Sq Ft: .72
3/4"W
1/4"T



#2354
PC: M102
Sq Ft: .72
1"W
1/4"T



#2355
PC: M102
Sq Ft: .79
1 3/16"W
1/4"T



#2356
PC: M102
Sq Ft: .96
1 7/16"W
1/4"T

For 1/8" Plywood



#2101
PC: M102
Sq Ft: .72
3/4"W
1/4"T



#2357
PC: M102
Sq Ft: .72
1"W
1/4"T



#2358
PC: M102
Sq Ft: .79
1 3/16"W
1/4"T



#2359
PC: M102
Sq Ft: .96
1 7/16"W
1/4"T

#2124
PC: M102
Sq Ft: .72
3/4"W
1/4"T



For Wood
Back Veneer

#870
PC: M102
Sq Ft: .72
3/4"W
5/16"T



For 1/8"
Plywood

#2023
PC: M101
Sq Ft: .72
3/4"W
7/16"T



For 1/4"
Plywood

► For PRICING ► See Section N.2 in our current Wholesale Pricing Catalog.

Molding Options

Refacing Molding

Solid Wood Refacing Stock (RFS100)

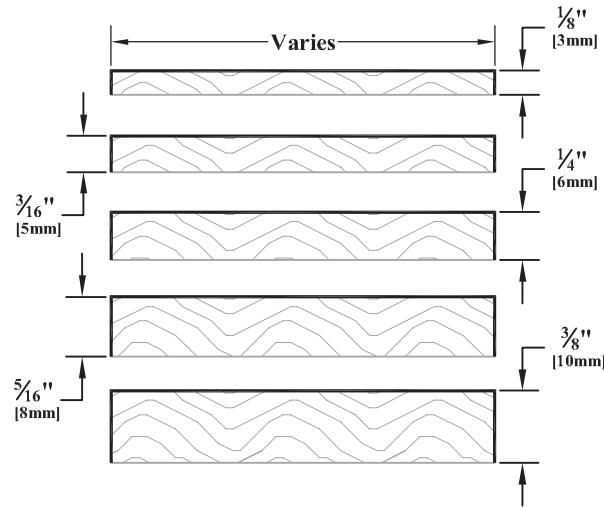

Ordering & Pricing Notes: Solid Wood Refacing Stock (RFS100)

Ordering Guidelines

1	Order Forms	Please use <i>Face Frame Stock Order Form (E-Z Form #9)</i> .
Pricing		
1	Pricing	Please see <i>Section N.2</i> of our current Wholesale Pricing Catalog.

Technical Notes: Solid Wood Refacing Stock (RFS100)

Finish Options (Chapter R)

1	Finishing	Solid Wood Refacing Stock will be considered a Two-Sided (2S) finished product. The backs will be sealed while the face and all edges will be sealed and top coated. Please see <i>Finish Section R.3</i> for information on Glazing.
---	-----------	---

Molding Options (Chapter N)

1	RFS100	Refacing Stock uses part #RFS100.
---	--------	-----------------------------------

Sizes / Dimensions

1	Thickness - RFS100	Available in 1/8" [3.2mm], 3/16" [4.8mm], 1/4" [6.4mm], 5/16" [7.9mm] and 3/8" [9.5mm] thicknesses.
2	Width - RFS100	Solid Wood Refacing Stock is available in a minimum width of 3/8" [15.9mm] and a maximum width of 6" [152.4mm]. 6" [152.4mm] Maximum Width: WalzCraft makes every attempt to produce these parts from one solid piece of wood. Due to lumber availability and/or wood species, widths under 6" [152.4mm] may need to be made from two or more edge glued pieces. For widths over 6" [152.4mm], please refer to our GUPFS product found in <i>Section M.16</i> .
3	Length - RFS100	Available in 8' [2438.4mm] Lengths, Cut-to-Length and Random Lengths. The minimum length for Cut-to-Length pieces is 3" [76.2mm]. Random length sizes vary between 36" [914.4mm] and 96" [2438.4mm] long. When measured, we round down to the next nearest 1/2 foot. Minimum quantity of 200 lineal feet. Solid wood refacing stock has a standard length of up to 96" [2438.4mm]. Lengths greater than 8' [2438.4mm] are subject to availability. <i>Please note that the choice of wood species and grade can impact the availability of lengths greater than 8' [2438.4mm].</i> See <i>Section N.12</i> for more information on molding lengths.
4	3D Laminate (RTF)	3D Laminate (RTF) Refacing Stock is made of a solid wood core (Maple - Paint Grade) and is not subject to the same thickness limitations as MDF. Only available in 8' [2438.4mm] lengths.

Wood Specie Options (Chapter S)

1	Knotty & Rustic Grades	Knotty and Rustic grade materials will only have small knots, if any.
---	------------------------	---

Refacing Molding - END

► For PRICING ► See Section N.2 in our current Wholesale Pricing Catalog.

Outside Corner Molding

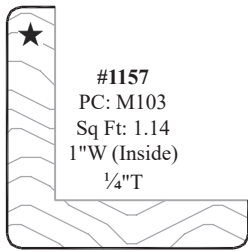

#1157
PC: M103
Sq Ft: 1.14
1"W (Inside)
1/4"T

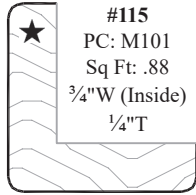

#115
PC: M101
Sq Ft: .88
3/4"W (Inside)
1/4"T

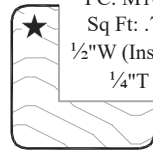

#114
PC: M101
Sq Ft: .72
1/2"W (Inside)
1/4"T

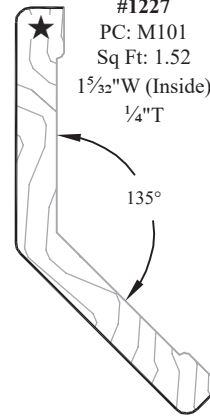

#1227
PC: M101
Sq Ft: 1.52
1 1/2"W (Inside)
1/4"T

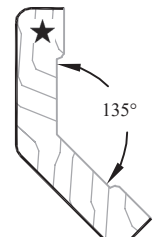

#1279
PC: M101
Sq Ft: .89
2 1/2"W (Inside)
1/4"T

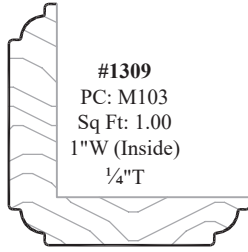

#1309
PC: M103
Sq Ft: 1.00
1"W (Inside)
1/4"T

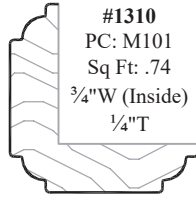

#1310
PC: M101
Sq Ft: .74
3/4"W (Inside)
1/4"T

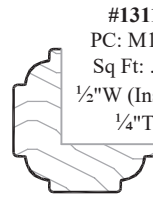

#1311
PC: M101
Sq Ft: .72
1/2"W (Inside)
1/4"T

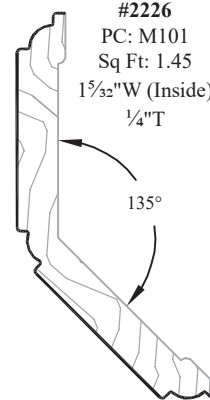

#2226
PC: M101
Sq Ft: 1.45
1 5/8"W (Inside)
1/4"T

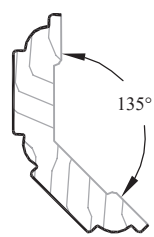

#2225
PC: M101
Sq Ft: .82
2 1/2"W (Inside)
1/4"T

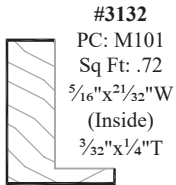

#3132
PC: M101
Sq Ft: .72
5/16"W (Inside)
3/32"x1/4"T

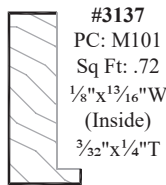

#3137
PC: M101
Sq Ft: .72
1/8"x1 3/16"W (Inside)
3/32"x1/4"T

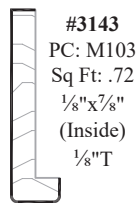

#3143
PC: M103
Sq Ft: .72
1/8"x7/8" (Inside)
1/8"T

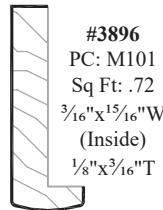

#3896
PC: M101
Sq Ft: .72
3/16"x1 5/16"W (Inside)
1/8"x3/16"T

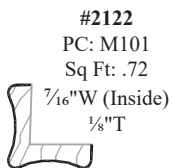

#2122
PC: M101
Sq Ft: .72
7/16"W (Inside)
1/8"T

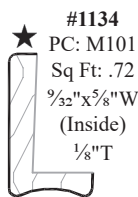

#1134
PC: M101
Sq Ft: .72
5/32"x5/8"W (Inside)
1/8"T

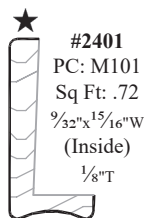

#2401
PC: M101
Sq Ft: .72
9/32"x1 5/16"W (Inside)
1/8"T

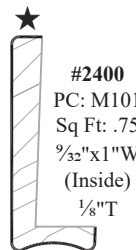

#2400
PC: M101
Sq Ft: .75
9/32"x1"W (Inside)
1/8"T

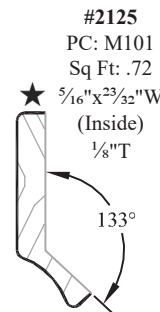

#2125
PC: M101
Sq Ft: .72
5/16"x2 3/32"W (Inside)
1/8"T

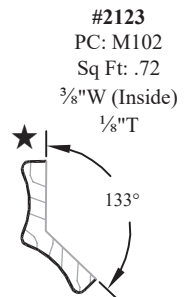

#2123
PC: M102
Sq Ft: .72
3/8"W (Inside)
1/8"T

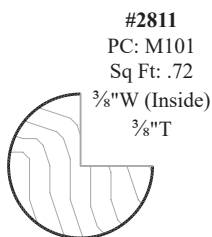

#2811
PC: M101
Sq Ft: .72
3/8"W (Inside)
3/8"T

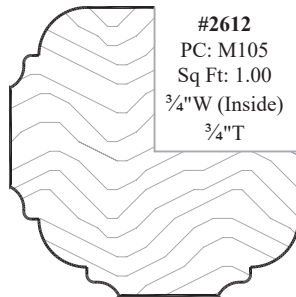

#2612
PC: M105
Sq Ft: 1.00
3/4"W (Inside)
3/4"T

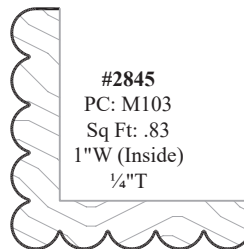

#2845
PC: M103
Sq Ft: .83
1"W (Inside)
1/4"T



#3214
PC: M101
Sq Ft: .72
3/8"W (Inside)
1/8"T

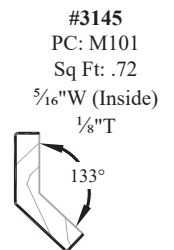

#3145
PC: M101
Sq Ft: .72
5/16"W (Inside)
1/8"T

► For PRICING ► See Section [N.3](#) in our current Wholesale Pricing Catalog.

Molding Options

Corner & Scribe Molding

Inside Corner Molding

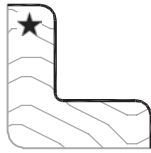

#1651
PC: M101
Sq Ft: .72
3/4"W (Outside)
1/4"T

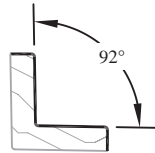

#3142
PC: M101
Sq Ft: .72
1/2"W (Outside)
1/8"T

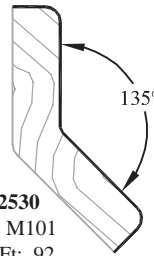

#2530
PC: M101
Sq Ft: .92
3/4"W (Outside)
1/4"T

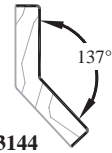

#3144
PC: M101
Sq Ft: .72
7/16"W (Outside)
1/8"T

Cove Molding



#311
PC: M101
Sq Ft: .72
1/2"D
1/2"H



#1689
PC: M101
Sq Ft: .72
5/8"D
5/8"H



#398
PC: M101
Sq Ft: .72
3/4"D
3/4"H

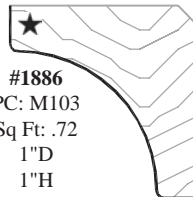

#1886
PC: M103
Sq Ft: .72
1"D
1"H

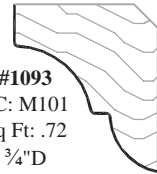

#1093
PC: M101
Sq Ft: .72
3/4"D
7/8"H

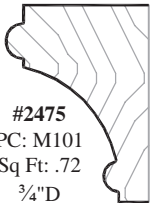

#2475
PC: M101
Sq Ft: .72
3/4"D
1 1/32"H

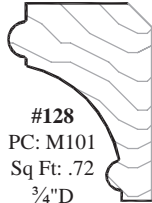

#128
PC: M101
Sq Ft: .72
3/4"D
1 1/32"H

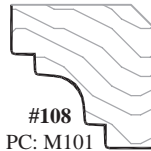

#108
PC: M101
Sq Ft: .72
3/4"D
3/4"H

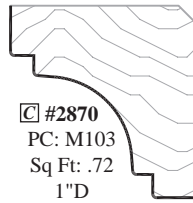

#2870
PC: M103
Sq Ft: .72
1"D
1"H

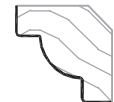

#1253
PC: M101
Sq Ft: .72
1/2"D
1/2"H

Base Shoe/Trim and Quarter Round Molding



#2152-LF
PC: M102
Sq Ft: .72
1/4"D
1/4"H



#2280
PC: M101
Sq Ft: .72
1/2"D
1/2"H



#112
PC: M101
Sq Ft: .72
1/2"D
3/4"H

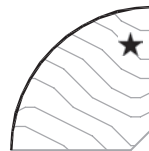

#110
PC: M101
Sq Ft: .72
3/4"D
3/4"H

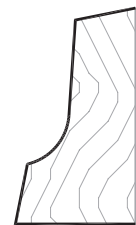

#2887
PC: M101
Sq Ft: .75
5/8"D
1 1/8"H

Continued on next page...

☐ = Available for Convex/Concave products.

★ = Available with 3D Laminate/RTF.

► For PRICING ► See Section **N.3** in our current Wholesale Pricing Catalog.

Scribe Molding



#1022
PC: M102
Sq Ft: .72
1/2"W
1/8"T



#2003
PC: M102
Sq Ft: .72
1"W
3/16"T



#2004
PC: M102
Sq Ft: 1.00
1 1/2"W
3/16"T

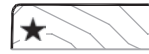

#147
PC: M102
Sq Ft: .72
3/4"W
1/4"T



#1391
PC: M102
Sq Ft: .72
1"W
1/4"T



#310
PC: M102
Sq Ft: .72
3/4"W
3/16"T



#1844
PC: M102
Sq Ft: .72
1"W
3/16"T



#1842
PC: M102
Sq Ft: 1.00
1 1/2"W
3/16"T



#2549
PC: M102
Sq Ft: 1.67
2 1/2"W
3/16"D

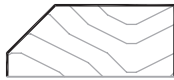

#1771
PC: M101
Sq Ft: .72
7/8"W
3/8"T



#1044
PC: M101
Sq Ft: 1.50
2 1/4"W
3/8"T



#1870
PC: M102
Sq Ft: .72
1"W
3/16"T

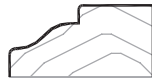

#2402
PC: M101
Sq Ft: .72
3/4"W
3/8"T



#309
PC: M102
Sq Ft: .72
1"W
5/16"T

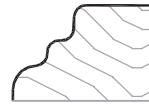

#887
PC: M101
Sq Ft: .72
3/4"W
1/2"T

Panel Splice Molding

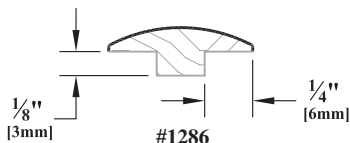

#1286
PC: M102
Sq Ft: .72
3/4"W
1/4"T

45° Cabinet Filler

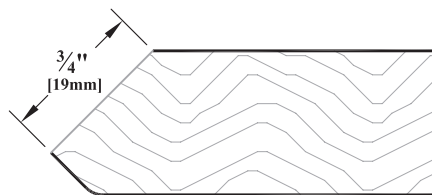

#1353
PC: M101
Sq Ft: 1.35
2"W
3/4"T

Continued on next page...

= Available for Convex/Concave products.

= Available with 3D Laminate/RTF.

► For PRICING ► See Section [N.3](#) in our current Wholesale Pricing Catalog.

Molding Options

Corner & Scribe Molding

45° Filler/Transition Molding

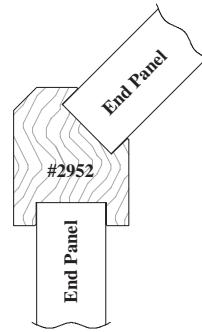
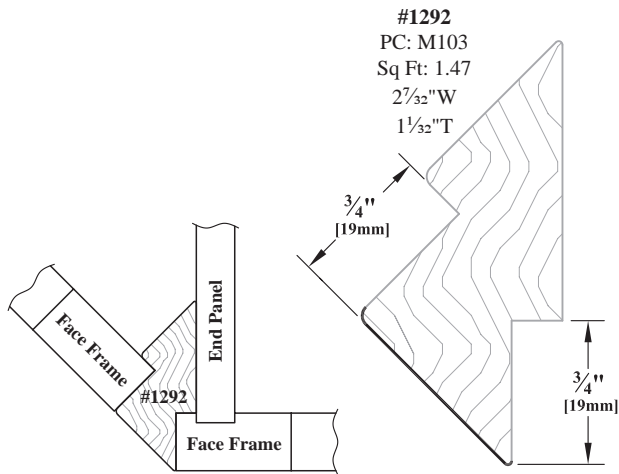

#2952
PC: M103
Sq Ft: 1.00
1¹/₂"W
1¹/₄"T

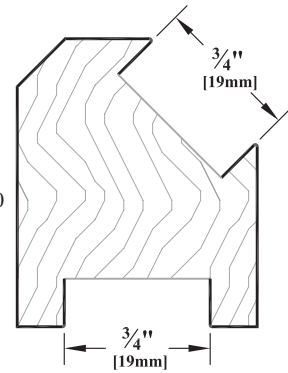

Application drawings not shown at full scale.

90° Corner Molding

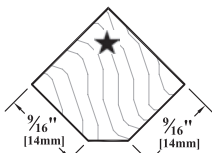

#1345
PC: M101
Sq Ft: .72
3/4"W
3/4"T

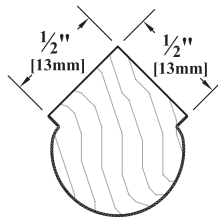

#1935
PC: M101
Sq Ft: .72
7/8"W
3/4"T

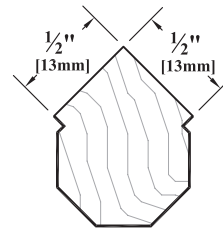

#1936
PC: M101
Sq Ft: .72
1⁵/₁₆"W
3/4"T

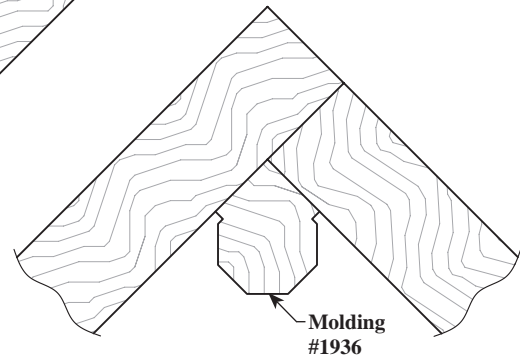
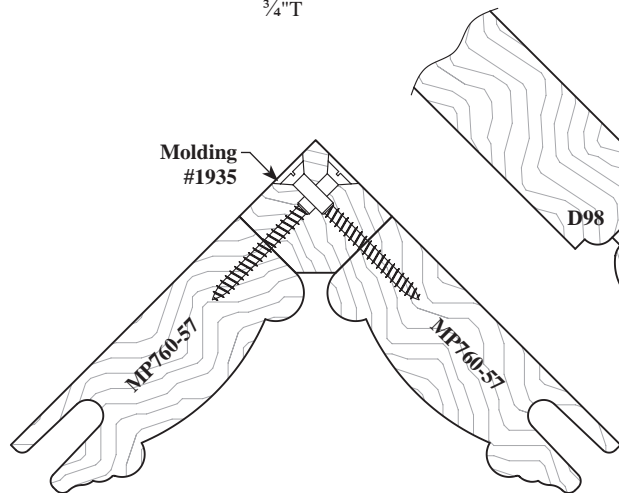

Application drawings not shown at full scale.

Continued on next page...

► For PRICING ► See Section [N.3](#) in our current Wholesale Pricing Catalog.

45° & 90° Corner Molding

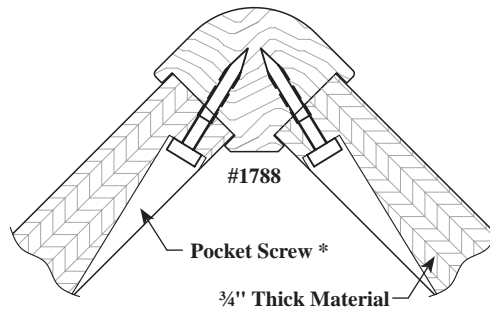

#2898
 PC: M103
 Sq Ft: 1.16
 1 3/4" W
 1 1/4" T

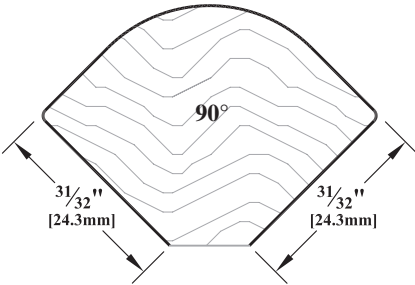

#1788
 PC: M103 + 3 Pass
 Molding Fee
 Sq Ft: 1.16
 See Notes in Section N.12

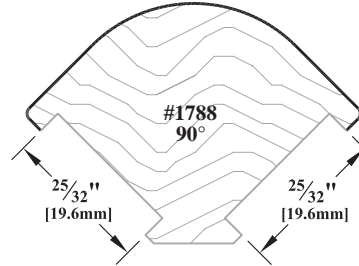

#2897
 PC: M105
 Sq Ft: 1.16
 1 3/4" W
 1 17/32" T

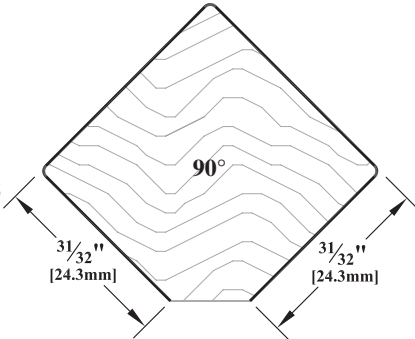

#1937
 PC: M105 + 3 Pass
 Molding Fee
 Sq Ft: 1.16
 See Notes in Section N.12

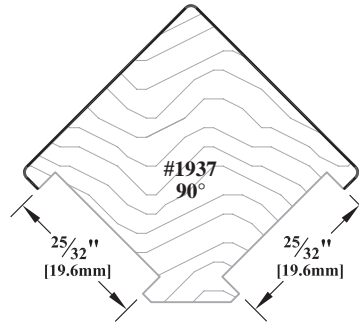

#2896
 PC: M103
 Sq Ft: .99
 1 15/32" W
 1 1/4" T

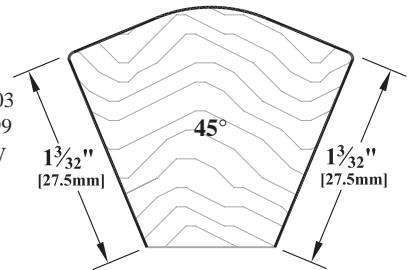

#2899
 PC: M103 + 3 Pass
 Molding Fee
 Sq Ft: .99
 See Notes in Section N.12

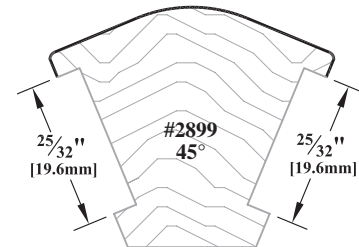

*Pocket screwing is just one possible method of attaching your 3/4" thick material to the corner molding. Application drawing not to scale.

Corner & Scribe Molding - END

Molding Options

Base & Casing Molding

#703
PC: M101
Sq Ft: 1.84
2¾"W
⅝"T

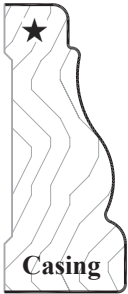

Casing

#702
PC: M101
Sq Ft: 1.50
2¼"W
⅝"T

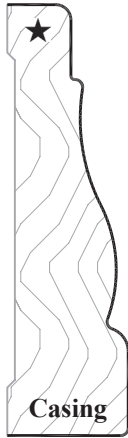

Casing

#701
PC: M101
Sq Ft: 1.00
1½"W
⅝"T

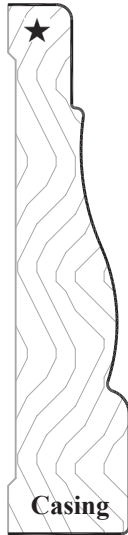

Casing

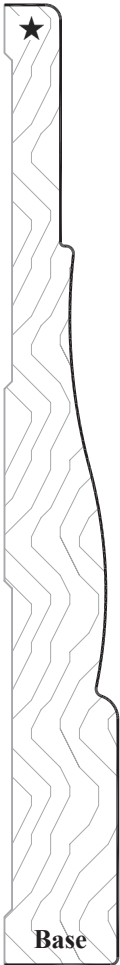

Base

#704
PC: M101
Sq Ft: 2.18
3⅜"W
1⅜"T

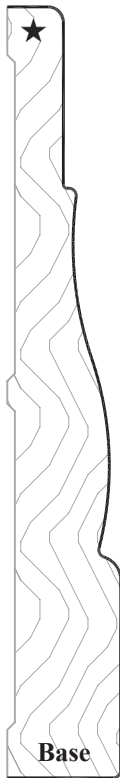

Base

#1229
PC: M101
Sq Ft: 2.68
4⅜"W
1⅜"T

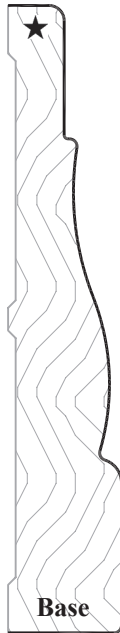

Base

#1637
PC: M101
Sq Ft: 3.33
5"W
1⅜"T

#926
PC: M101
Sq Ft: 1.00
1½"W
⅝"T



Casing



Base

#1638
PC: M101
Sq Ft: 3.33
5"W
1⅜"T

#927
PC: M101
Sq Ft: 1.50
2¼"W
⅝"T



Casing



Base

#1233
PC: M101
Sq Ft: 2.68
4⅜"W
1⅜"T

#928
PC: M101
Sq Ft: 1.84
2¾"W
⅝"T



Casing



Base

#929
PC: M101
Sq Ft: 2.18
3⅜"W
1⅜"T

☐ = Available for Convex/Concave products. ★ = Available with 3D Laminate/RTF.

► For PRICING ► See Section N.4 in our current Wholesale Pricing Catalog.

#705
PC: M101
Sq Ft: 1.00
1½"W
⅝"T

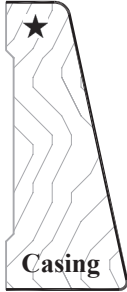

Casing

#706
PC: M101
Sq Ft: 1.50
2¼"W
⅝"T

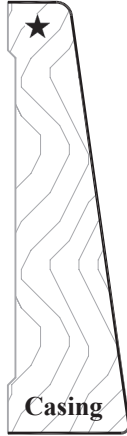

Casing

#707
PC: M101
Sq Ft: 1.84
2¾"W
⅝"T

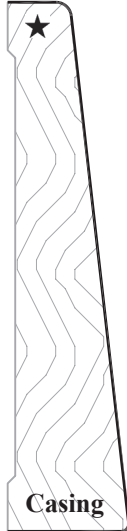

Casing



Base

#1635
PC: M101
Sq Ft: 3.33
5"W
1⅞"T

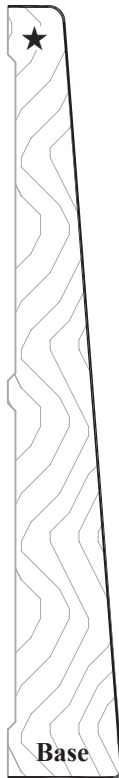

Base

#1230
PC: M101
Sq Ft: 2.68
4½"W
1⅞"T

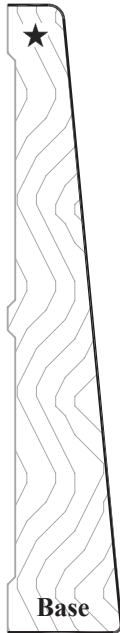

Base

#708
PC: M101
Sq Ft: 2.18
3⅞"W
1⅞"T

☐ #709
PC: M101
Sq Ft: 1.00
1½"W
⅝"T



Casing

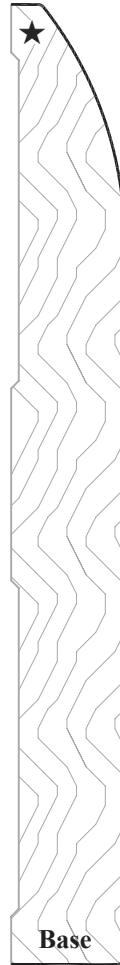

Base

☐ #1639
PC: M101
Sq Ft: 3.33
5"W
1⅞"T

☐ #710
PC: M101
Sq Ft: 1.50
2¼"W
⅝"T



Casing



Base

☐ #1193
PC: M101
Sq Ft: 2.68
4½"W
1⅞"T

☐ #711
PC: M101
Sq Ft: 1.84
2¾"W
⅝"T



Casing



Base

☐ #712
PC: M101
Sq Ft: 2.18
3⅞"W
1⅞"T

☐ = Available for Convex/Concave products. ★ = Available with 3D Laminate/RTF.

► For PRICING ► See Section N.4 in our current Wholesale Pricing Catalog.

Molding Options

Base & Casing Molding

#2080
PC: M101
Sq Ft: 1.00
1½"W
⅝"T



Casing

#2081
PC: M101
Sq Ft: 1.50
2¼"W
⅝"T

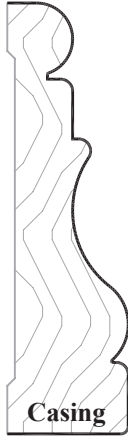

Casing

#2082
PC: M101
Sq Ft: 1.84
2¾"W
⅝"T

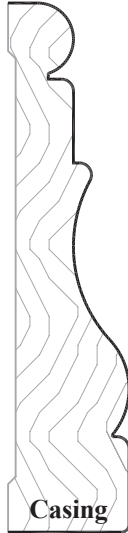

Casing

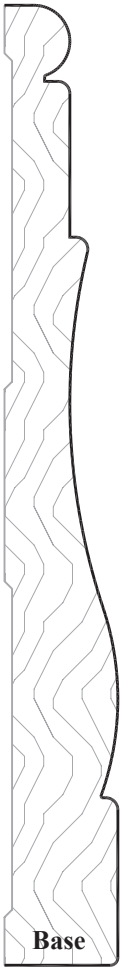

Base

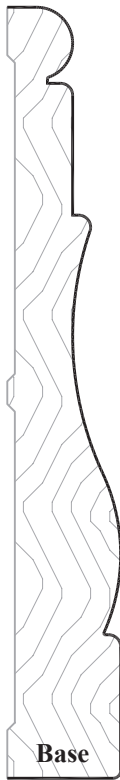

Base



Base

#2085
PC: M101
Sq Ft: 3.33
5"W
1⅞"T

#2084
PC: M101
Sq Ft: 2.68
4⅜"W
1⅞"T

#2083
PC: M101
Sq Ft: 2.18
3⅝"W
1⅞"T

#1099
PC: M101
Sq Ft: 1.00
1½"W
⅝"T



Casing



Base

#1098
PC: M101
Sq Ft: 1.50
2¼"W
⅝"T



Casing



Base

#1097
PC: M101
Sq Ft: 1.84
2¾"W
⅝"T



Casing



Base

#1636
PC: M101
Sq Ft: 3.33
5"W
1⅞"T

#1231
PC: M101
Sq Ft: 2.68
4⅜"W
1⅞"T

#1096
PC: M101
Sq Ft: 2.18
3⅝"W
1⅞"T

☐ = Available for Convex/Concave products. ★ = Available with 3D Laminate/RTF.

► For PRICING ► See Section N.4 in our current Wholesale Pricing Catalog.

C #1103
PC: M101
Sq Ft: 1.00
1½"W
⅝"T

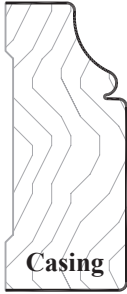

C #1102
PC: M101
Sq Ft: 1.50
2¼"W
⅝"T



C #1101
PC: M101
Sq Ft: 1.84
2¾"W
⅝"T



C #1632
PC: M101
Sq Ft: 3.33
5"W
1⅞"T

C #1232
PC: M101
Sq Ft: 2.68
4⅜"W
1⅞"T

C #1100
PC: M101
Sq Ft: 2.18
3⅝"W
1⅞"T

#1382
PC: M101
Sq Ft: 1.00
1½"W
⅝"T



#1381
PC: M101
Sq Ft: 1.50
2¼"W
⅝"T



#1380
PC: M101
Sq Ft: 1.84
2¾"W
⅝"T

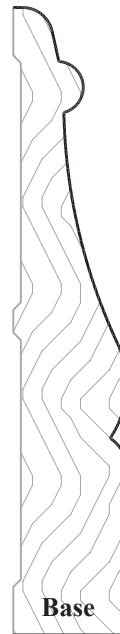
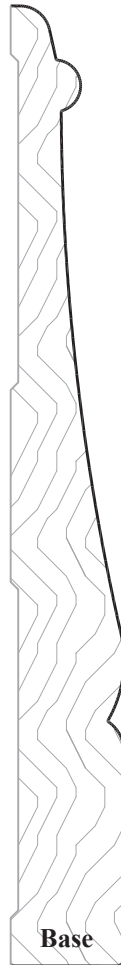
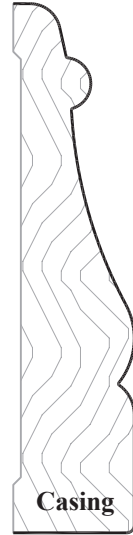

#1640
PC: M101
Sq Ft: 3.33
5"W
1⅞"T

#1378
PC: M101
Sq Ft: 2.68
4⅜"W
1⅞"T

#1379
PC: M101
Sq Ft: 2.18
3⅝"W
1⅞"T

C = Available for Convex/Concave products. ★ = Available with 3D Laminate/RTF.

► For PRICING ► See Section N.4 in our current Wholesale Pricing Catalog.

N

#2880
 PC: M101
 Sq Ft: 1.50
 2 1/4"W
 3/4"T



Base

#2546
 PC: M101
 Sq Ft: 3.99
 5 31/32"W
 2 3/32"T

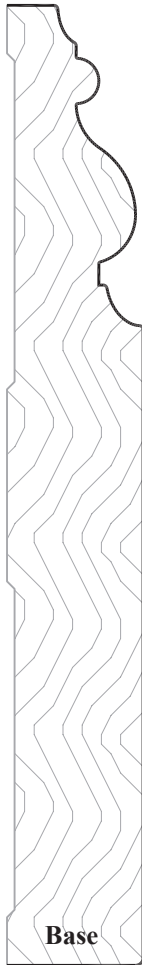

Base

#2547
 PC: M101
 Sq Ft: 3.33
 5"W
 2 3/32"T

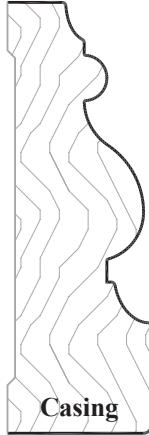

Casing



Casing

#2548
 PC: M101
 Sq Ft: 1.99
 3"W
 3/4"T

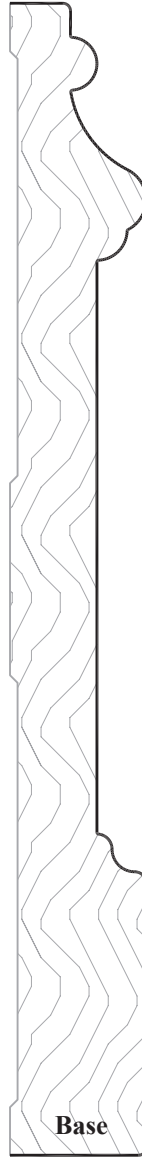

Base

#1829
 PC: M101
 Sq Ft: 4.00
 6"W
 2 3/32"T

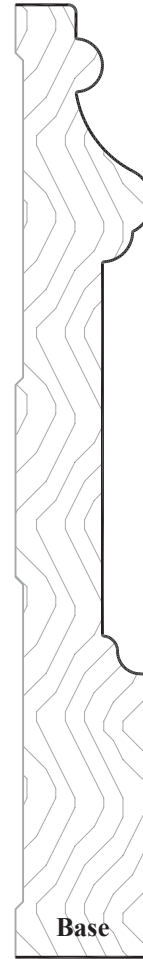

Base

#960
 PC: M101
 Sq Ft: 3.31
 4 31/32"W
 2 3/32"T

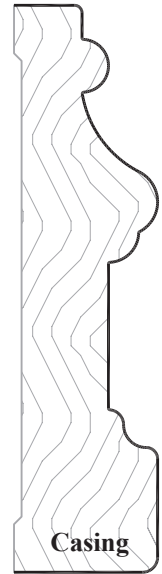

Casing

#1228
 PC: M101
 Sq Ft: 1.97
 2 15/16"W
 3/4"T

☐ = Available for Convex/Concave products. ★ = Available with 3D Laminate/RTF.

► For PRICING ► See Section N.4 in our current Wholesale Pricing Catalog.

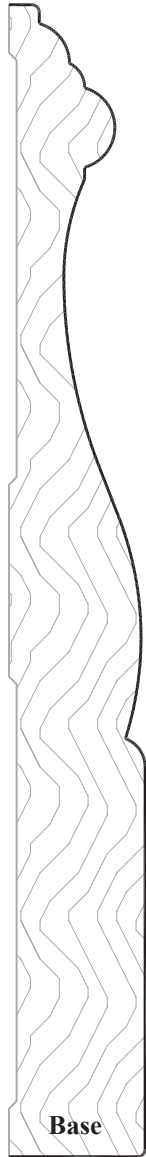

#1299
PC: M101
Sq Ft: 4.00
6"W
2³/₃₂"T

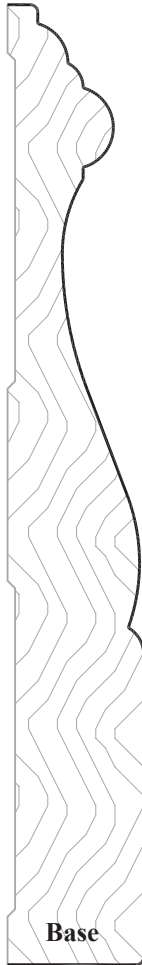

#1178
PC: M101
Sq Ft: 3.33
5"W
2³/₃₂"T

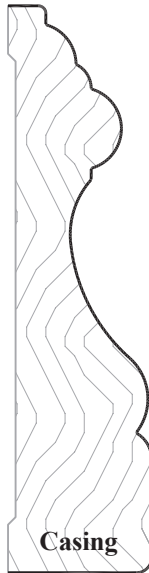

#961
PC: M101
Sq Ft: 1.97
2¹/₁₆"W
3/4"T



#1828
PC: M101
Sq Ft: 1.97
2¹/₁₆"W
3/4"T



#1316
PC: M101
Sq Ft: 2.83
4¹/₄"W
2³/₃₂"T



#1848
PC: M101
Sq Ft: 3.31
5"W
2³/₃₂"T

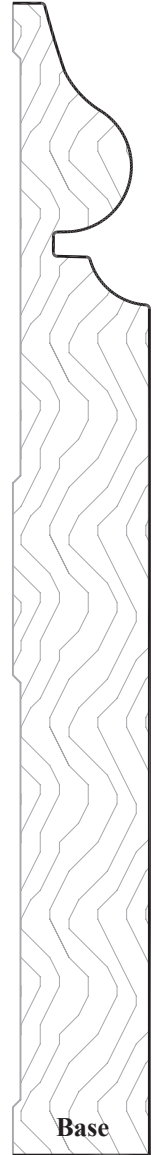

#1847
PC: M101
Sq Ft: 4.00
6"W
2³/₃₂"T

C = Available for Convex/Concave products. **★** = Available with 3D Laminate/RTF.

► For PRICING ► See Section N.4 in our current Wholesale Pricing Catalog.

N

Molding Options

Applied Molding

Applied Moldings - Outside Edge



☐ #2817-LF
PC: M102
Sq Ft: .72
1/4"W
3/4"T

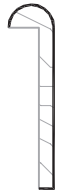

☐ #846-LF
PC: M103
Sq Ft: .72
1/4"W
3 1/32"T



☐ #1354-LF
PC: M103
Sq Ft: .76
1/4"W
1 1/8"T



#1143-LF
PC: M101
Sq Ft: .72
1 5/32"W
2 3/32"T



#1142-LF
PC: M103
Sq Ft: .72
1 5/32"W
3 1/32"T



#1180-LF
PC: M103
Sq Ft: .72
1 1/16"W
7/8"T



#1184-LF
PC: M103
Sq Ft: .75
1 1/16"W
1 1/8"T

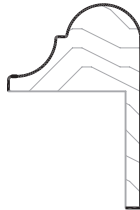

☐ #1264-LF
PC: M103
Sq Ft: .72
1 1/16"W
1 1/32"T

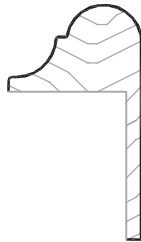

#2094-LF
PC: M103
Sq Ft: .82
1 1/16"W
1 7/32"T

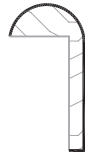

☐ #852-LF
PC: M101
Sq Ft: .72
1 3/32"W
2 3/32"T



☐ #851-LF
PC: M103
Sq Ft: .72
1 3/32"W
3 1/32"T



☐ #1993-LF
PC: M103
Sq Ft: .78
1 3/32"W
1 7/32"T



#1891-LF
PC: M101
Sq Ft: .72
1/2"W
2 5/32"T



☐ #2092-LF
PC: M103
Sq Ft: .72
1/2"W
1"T



#2093-LF
PC: M103
Sq Ft: .82
1/2"W
1 7/32"T

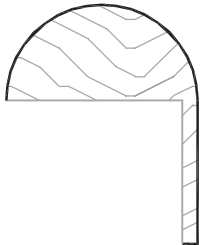

#1156-LF
PC: M103
Sq Ft: .72
1"W
1 1/4"T

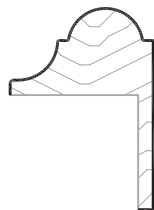

☐ #894-LF
PC: M103
Sq Ft: .72
3/4"W
1 1/32"T

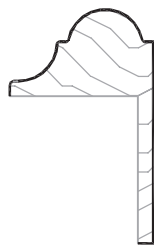

☐ #1347-LF
PC: M103
Sq Ft: .72
3/4"W
1 7/32"T



#1081-LF
PC: M103
Sq Ft: .72
1/2"W
3 1/32"T

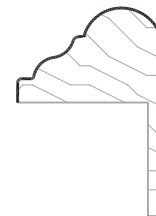

#1206-LF
PC: M103
Sq Ft: .72
3/4"W
1 1/32"T

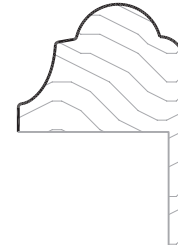

☐ #1277-LF
PC: M103
Sq Ft: .72
7/8"W
1 1/32"T

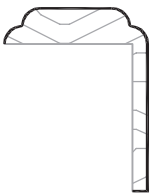

#1278-LF
PC: M103
Sq Ft: .72
3/4"W
3 1/32"T

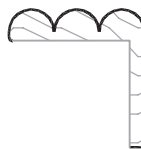

#1284-LF
PC: M101
Sq Ft: .72
2 3/32"W
2 3/32"T



#1301-LF
PC: M103
Sq Ft: .72
1/4"W
2 9/32"T



#1328-LF
PC: M103
Sq Ft: .72
7/8"W
2 7/32"T



#1337-LF
PC: M103
Sq Ft: .72
2 1/32"W
7/8"T

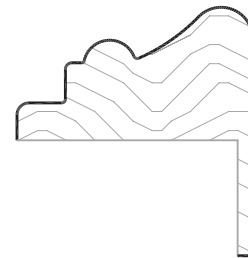

☐ #1646-LF
PC: M103
Sq Ft: .82
1 7/32"W
1 1/4"T

☐ = Available for Convex/Concave products.

☐ = Available radiused to follow the contour of shaped rails.

► For PRICING ► See Section N.5 in our current Wholesale Pricing Catalog.

Applied Moldings - Outside Edge

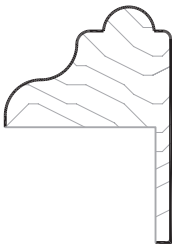

#1656-LF
PC: M103
Sq Ft: .72
7/8"W
1 1/16"T



#1680-LF
PC: M101
Sq Ft: .72
1 7/32"W
2 3/32"T

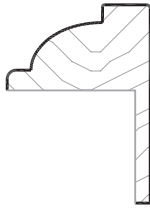

#1995-LF
PC: M103
Sq Ft: .72
3/4"W
1"T

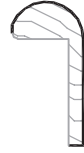

#2366-LF
PC: M101
Sq Ft: .72
3/8"W
3/4"T



#2367-LF
PC: M103
Sq Ft: .72
3/8"W
1"T

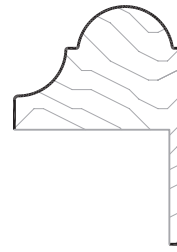

#2471-LF
PC: M103
Sq Ft: .80
2 9/32"W
1 1/32"T

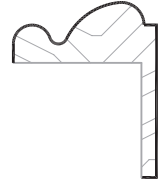

#2564-LF
PC: M101
Sq Ft: .72
3/4"W
7/8"T



#2593-LF
PC: M101
Sq Ft: .72
1/4"W
2 3/32"T



#2592-LF
PC: M103
Sq Ft: .72
1/4"W
3 1/32"T

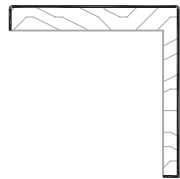

#2621-LF
PC: M103
Sq Ft: .72
7/8"W
7/8"T

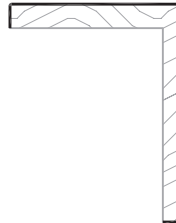

#2622-LF
PC: M103
Sq Ft: .72
7/8"W
1 1/8"T



#2696-LF
PC: M101
Sq Ft: .72
7/16"W
3/4"T

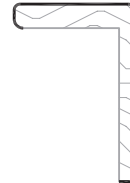

#2752-LF
PC: M103
Sq Ft: .72
5/8"W
1 5/16"T

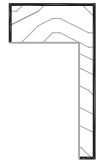

#2930-LF
PC: M101
Sq Ft: .72
7/16"W
3/4"T

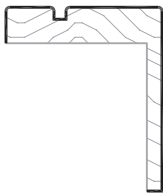

#2931-LF
PC: M103
Sq Ft: .72
1 3/16"W
3 1/32"T

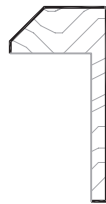

#3043-LF
PC: M103
Sq Ft: .72
1/2"W
1"T

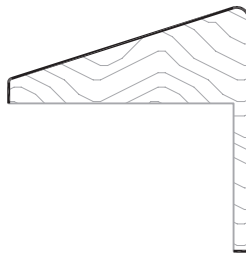

#3047-LF
PC: M103
Sq Ft: .85
1 1/4"W
1 1/32"T

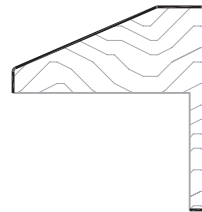

#3121-LF
PC: M103
Sq Ft: .72
1"W
1"T

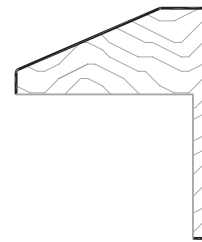

#3151-LF
PC: M103
Sq Ft: .72
1"W
1 1/4"T

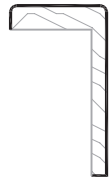

#3124-LF
PC: M103
Sq Ft: .72
1/2"W
7/8"T



#3141-LF
PC: M103
Sq Ft: .72
1/2"W
7/8"T

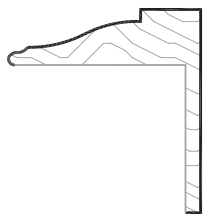

#3158-LF
PC: M103
Sq Ft: .72
1"W
1 1/32"T

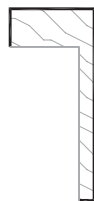

#3194-LF
PC: M103
Sq Ft: .72
7/16"W
1"T

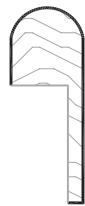

#3197-LF
PC: M103
Sq Ft: .72
3/8"W
1 1/32"T



#3198-LF
PC: M103
Sq Ft: .72
1/4"W
3 1/32"T

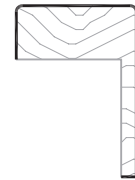

#3199-LF
PC: M103
Sq Ft: .72
5/8"W
2 9/32"T

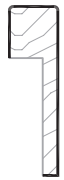

#3200-LF
PC: M103
Sq Ft: .72
1/4"W
7/8"T

C = Available for Convex/Concave products.

R = Available radiused to follow the contour of shaped rails.

► For PRICING ► See Section N.5 in our current Wholesale Pricing Catalog.

Molding Options

Applied Molding

Applied Moldings - Inside Edge/Shelf/Face

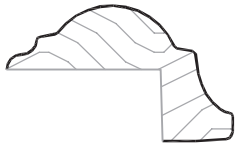

R C #101
PC: M101
Sq Ft: .79
1 3/16"W
2 3/32"T

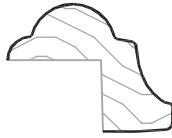

R C #102
PC: M101
Sq Ft: .72
7/8"W
2 1/32"T



#103
PC: M101
Sq Ft: 1.04
1 1/16"W
3/4"T

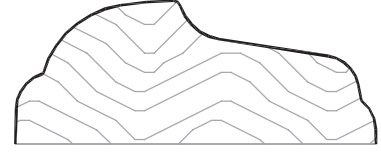

#805
PC: M101
Sq Ft: 1.25
1 7/8"W
3/4"T



R #3167-LF
PC: M102
Sq Ft: .72
1/4"W
1/8"T



#238
PC: M102
Sq Ft: .72
1/2"W
1/4"T



#239
PC: M101
Sq Ft: .72
3/4"W
3/8"T



#240
PC: M101
Sq Ft: .72
1"W
1/2"T

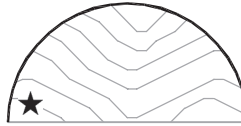

#241
PC: M101
Sq Ft: .83
1 1/4"W
5/8"T



#386-LF
PC: M102
Sq Ft: .72
1/4"W
1/4"T



R C #387
PC: M101
Sq Ft: .72
3/4"W
1 5/32"T

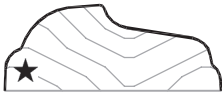

#806
PC: M101
Sq Ft: .75
1 1/8"W
7/16"T

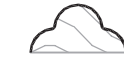

R C #808
PC: M102
Sq Ft: .72
1/2"W
1/4"T



R C #826-LF
PC: M102
Sq Ft: .72
5/32"W
1 1/32"T

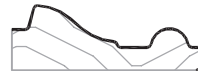

R C #827
PC: M102
Sq Ft: .72
1"W
1 1/32"T



C #876
PC: M101
Sq Ft: .72
7/16"W
1 1/32"T



R #881
PC: M101
Sq Ft: .72
7/8"W
5/8"T

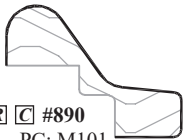

R C #890
PC: M101
Sq Ft: .72
2 9/32"W
1 1/16"T



R C #922
PC: M101
Sq Ft: .72
3/4"W
3/8"T



#945
PC: M101
Sq Ft: .72
5/16"W
5/16"T



R #954-LF
PC: M102
Sq Ft: .72
5/32"W
5/32"T



#970-LF
PC: M102
Sq Ft: .72
5/16"W
7/32"T

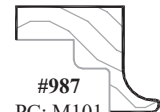

#987
PC: M101
Sq Ft: .72
3/4"W
5/16"T



#1023
PC: M102
Sq Ft: .72
3/4"W
1 1/32"T



R #1041
PC: M101
Sq Ft: .74
1 3/32"W
3/4"T



R C #1043
PC: M102
Sq Ft: .72
3/4"W
5/16"T

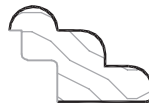

#1088
PC: M101
Sq Ft: .72
3/4"W
1/2"T



R C #1089
PC: M101
Sq Ft: .72
7/8"W
2 1/32"T













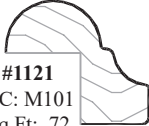
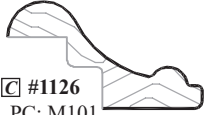
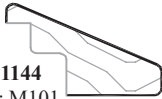
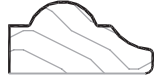



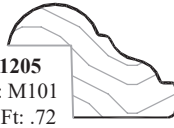





R #1112
PC: M101
Sq Ft: .72
3 1/32"W
1/2"T

C = Available for Convex/Concave products.

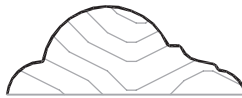
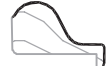
R = Available radiused to follow the contour of shaped rails.

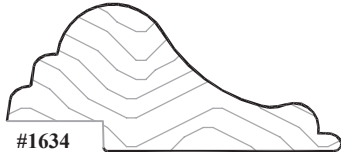
► For PRICING ► See Section N.5 in our current Wholesale Pricing Catalog.

Applied Moldings - Inside Edge/Shelf/Face...continued

 <p>R C #1121 PC: M101 Sq Ft: .72 3/4"W 2 1/32"T</p>	 <p>C #1126 PC: M101 Sq Ft: .72 1 1/32"W 9/16"T</p>	 <p>#1144 PC: M101 Sq Ft: .72 1 3/16"W 1 5/32"T</p>	 <p>#1145 PC: M101 Sq Ft: .72 3/4"W 3/8"T</p>	 <p>#1148 PC: M101 Sq Ft: .75 1 1/8"W 5/8"T</p>	
 <p>R C #1170 PC: M101 Sq Ft: .83 1 1/4"W 1 1/16"T</p>	 <p>R #1174-LF PC: M102 Sq Ft: .72 3/8"W 3/32"T</p>	 <p>R #1175 PC: M101 Sq Ft: .72 1/2"W 1 3/32"T</p>	 <p>R C #1205 PC: M101 Sq Ft: .72 7/8"W 1 9/32"T</p>	 <p>R #1208 PC: M101 Sq Ft: .72 2 7/32"W 2 1/32"T</p>	
 <p>R #1210 PC: M101 Sq Ft: .72 3/4"W 1 7/32"T</p>	 <p>R #1234 PC: M101 Sq Ft: .72 1"W 1 7/32"T</p>	 <p>#1252-LF PC: M101 Sq Ft: .72 5/16"W 1/2"T</p>	 <p>R C #1275-LF PC: M101 Sq Ft: .72 1/4"W 1/2"T</p>	 <p>R C #1276-LF PC: M101 Sq Ft: .72 1 3/32"W 1 7/32"T</p>	 <p>R C #1280 PC: M102 Sq Ft: .72 1"W 1 1/32"T</p>
 <p>#1308 PC: M101 Sq Ft: .79 1 3/16"W 1 1/16"T</p>	 <p>C #1344 PC: M102 Sq Ft: .72 1 3/16"W 9/32"T</p>	 <p>#1350 PC: M101 Sq Ft: .83 1 1/4"W 1 5/32"T</p>	 <p>C #1360-LF PC: M101 Sq Ft: .72 7/16"W 1 1/32"T</p>	 <p>R C #1363 PC: M101 Sq Ft: .72 3/4"W 3/8"T</p>	
 <p>#1629 PC: M102 Sq Ft: .72 3/4"W 5/16"T</p>	 <p>#1634 PC: M101 Sq Ft: 1.16 1 3/4"W 2 5/32"T</p>	 <p>C #1657-LF PC: M102 Sq Ft: .72 1 1/16"W 1 1/32"T</p>	 <p>#1661 PC: M101 Sq Ft: .72 1 3/16"W 9/16"T</p>	 <p>#1662 PC: M101 Sq Ft: .72 1 3/16"W 9/16"T</p>	 <p>#1663 PC: M101 Sq Ft: .72 1 1/16"W 1 3/32"T</p>

C = Available for Convex/Concave products. **R** = Available radiused to follow the contour of shaped rails.

► For PRICING ► See Section N.5 in our current Wholesale Pricing Catalog.

Applied Moldings - Inside Edge/Shelf/Face...continued



#1664
PC: M102
Sq Ft: .72
1¹/₁₆"W
3¹/₃₂"T



#1681
PC: M101
Sq Ft: .72
3¹/₄"W
3¹/₈"T



#1685
PC: M101
Sq Ft: .72
2¹/₃₂"W
3¹/₈"T



#1690
PC: M102
Sq Ft: .72
1³/₁₆"W
1¹/₃₂"T

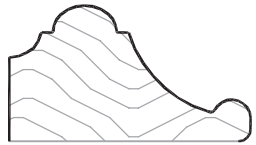

#1691
PC: M101
Sq Ft: .84
1¹/₄"W
2³/₃₂"T

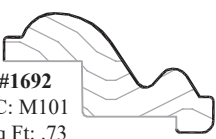

#1692
PC: M101
Sq Ft: .73
1³/₃₂"W
5¹/₈"T



#1693
PC: M102
Sq Ft: .72
1¹/₂"W
5¹/₁₆"T



#1694
PC: M102
Sq Ft: .72
2⁷/₃₂"W
5¹/₁₆"T

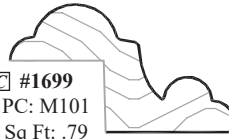

#1699
PC: M101
Sq Ft: .79
1³/₁₆"W
2¹/₃₂"T

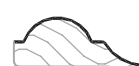

#1717
PC: M102
Sq Ft: .72
1¹/₁₆"W
1¹/₃₂"T



#1718
PC: M102
Sq Ft: .72
1¹/₁₆"W
5¹/₁₆"T



#1721-LF
PC: M102
Sq Ft: .72
3¹/₃₂"W
1¹/₃₂"T



#1722
PC: M101
Sq Ft: .72
7¹/₁₆"W
1¹/₃₂"T

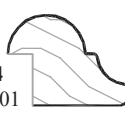

#1734
PC: M101
Sq Ft: .72
5¹/₈"W
1⁵/₃₂"T



#1745-LF
PC: M102
Sq Ft: .72
1⁵/₃₂"W
5¹/₁₆"T



#1746
PC: M102
Sq Ft: .72
1⁹/₃₂"W
1¹/₃₂"T



#1751
PC: M101
Sq Ft: .84
1¹/₄"W
5¹/₈"T



#1752-LF
PC: M102
Sq Ft: .72
3¹/₈"W
3¹/₃₂"T



#1755-LF
PC: M102
Sq Ft: .72
7¹/₃₂"W
3¹/₃₂"T



#1770
PC: M102
Sq Ft: .72
1¹/₄"W
5¹/₈"T



#1777
PC: M101
Sq Ft: .72
2⁹/₃₂"W
2¹/₃₂"T



#1809
PC: M101
Sq Ft: .72
2¹/₃₂"W
1¹/₂"T

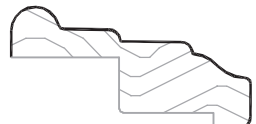

#1811
PC: M101
Sq Ft: .83
1¹/₄"W
5¹/₈"T



#1832
PC: M102
Sq Ft: .72
1¹/₁₆"W
1¹/₄"T



#1834-LF
PC: M102
Sq Ft: .72
3¹/₃₂"W
3¹/₃₂"T



#1858-LF
PC: M102
Sq Ft: .72
3¹/₃₂"W
3¹/₃₂"T



#1861-LF
PC: M102
Sq Ft: .72
5¹/₁₆"W
7¹/₃₂"T



#1862-LF
PC: M102
Sq Ft: .72
1¹/₄"W
1¹/₄"T



#1864
PC: M101
Sq Ft: .72
2⁷/₃₂"W
3¹/₄"T

C = Available for Convex/Concave products. **R** = Available radiused to follow the contour of shaped rails.

► For PRICING ► See Section N.5 in our current Wholesale Pricing Catalog.

Applied Moldings - Inside Edge/Shelf/Face...continued



#1874
PC: M101
Sq Ft: .72
1⁵/₁₆"W
3⁸"T



#1875
PC: M102
Sq Ft: .84
1¹/₄"W
1⁴"T



R **#1876**
PC: M102
Sq Ft: .72
5⁸"W
1⁴"T

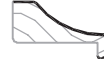

C **#1880-LF**
PC: M102
Sq Ft: .72
1²"W
5¹⁶"T



#1881
PC: M103
Sq Ft: .76
1¹/₈"W
2⁹/₃₂"T



#1900
PC: M102
Sq Ft: .72
1³/₃₂"W
7³²"T



R **#1901**
PC: M102
Sq Ft: .72
1²"W
1⁴"T



#1903
PC: M102
Sq Ft: .72
1¹/₁₆"W
5¹⁶"T



#1905
PC: M102
Sq Ft: .72
7⁸"W
1⁴"T



C **#1907**
PC: M101
Sq Ft: .72
1¹/₁₆"W
1²"T



#1912-LF
PC: M102
Sq Ft: .72
1²"W
3¹⁶"T



#1913-LF
PC: M102
Sq Ft: .72
1⁴"W
5³²"T



#1922
PC: M102
Sq Ft: .75
1¹/₈"W
1¹/₃₂"T



#1927
PC: M101
Sq Ft: .74
1¹/₈"W
1²"T



C **#1970-LF**
PC: M101
Sq Ft: .72
1¹/₃₂"W
3⁸"T



#2007
PC: M101
Sq Ft: .72
1²"W
1²"T

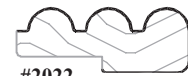

#2022
PC: M102
Sq Ft: .72
2⁹/₃₂"W
1¹/₃₂"T



#2052
PC: M101
Sq Ft: .72
1¹/₃₂"W
3⁸"T



#2053
PC: M101
Sq Ft: .72
3⁸"W
3⁸"T



#2054
PC: M101
Sq Ft: .72
1¹⁶"
1¹⁶"

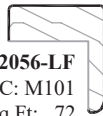

#2056-LF
PC: M101
Sq Ft: .72
1²"W
1¹⁶"T



#2057-LF
PC: M101
Sq Ft: .72
1²"W
1¹⁶"T

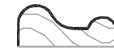

#2075
PC: M102
Sq Ft: .72
1⁷/₃₂"W
7³²"T

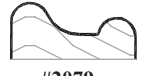

#2079
PC: M102
Sq Ft: .72
2¹/₃₂"W
5³²"T



#2091
PC: M102
Sq Ft: .72
3⁸"W
3⁸"T

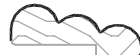

#2095
PC: M102
Sq Ft: .72
1¹/₁₆"W
5³²"T

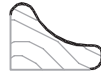

#2172
PC: M102
Sq Ft: .72
1⁵/₃₂"W
1¹/₃₂"T

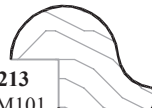

#2213
PC: M101
Sq Ft: .72
3⁴"W
1¹⁶"T



#2286
PC: M101
Sq Ft: .72
3⁴"W
5⁸"T



#2297
PC: M102
Sq Ft: .72
1"W
1¹⁶"T

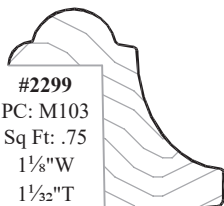

#2299
PC: M103
Sq Ft: .75
1¹/₈"W
1¹/₃₂"T

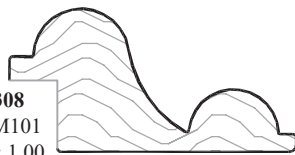

#2308
PC: M101
Sq Ft: 1.00
1¹/₂"W
3⁴"T

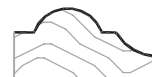

#2315
PC: M101
Sq Ft: .72
3⁴"W
3⁸"T



#2328-LF
PC: M102
Sq Ft: .72
5³²"W
1⁴"T



#2385-LF
PC: M102
Sq Ft: .72
7¹⁶"W
3¹⁶"T

C = Available for Convex/Concave products. **R** = Available radiused to follow the contour of shaped rails.

► For PRICING ► See Section N.5 in our current Wholesale Pricing Catalog.

Applied Moldings - Inside Edge/Shelf/Face...continued



#2397
PC: M101
Sq Ft: .72
5/8"W
1 1/32"T

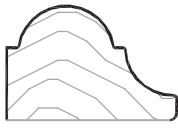

#2398
PC: M101
Sq Ft: .72
2 9/32"W
1 9/32"T



#2405
PC: M102
Sq Ft: .72
1/2"W
3/32"T

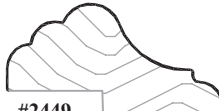

#2449
PC: M101
Sq Ft: .75
1 1/8"W
1 9/32"T

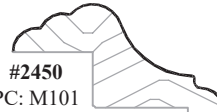

#2450
PC: M101
Sq Ft: .74
1 3/32"W
5/8"T



#2451
PC: M101
Sq Ft: .72
1 5/16"W
5/8"T



#2492
PC: M101
Sq Ft: .72
1 1/4"W
3/4"T

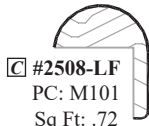

#2508-LF
PC: M101
Sq Ft: .72
1/2"W
1 9/32"T



#2528-LF
PC: M102
Sq Ft: .72
9/32"W
1/4"T

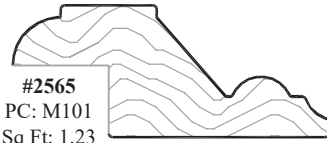

#2565
PC: M101
Sq Ft: 1.23
1 1/16"W
1 1/16"T



#2588
PC: M102
Sq Ft: .72
1/2"W
3/32"T



#2596
PC: M101
Sq Ft: .72
1 3/16"W
1 7/32"T



#2597-LF
PC: M101
Sq Ft: .72
3/8"W
1 5/32"T

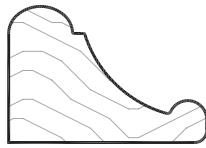

#2625
PC: M101
Sq Ft: .72
1 1/32"W
2 3/32"T



#2627
PC: M102
Sq Ft: .72
7/8"W
3/32"T



#2628
PC: M101
Sq Ft: .72
1 5/16"W
5/8"T

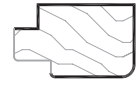

#2630
PC: M101
Sq Ft: .72
5/8"W
3/8"T

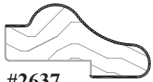

#2637
PC: M101
Sq Ft: .72
3/4"W
3/8"T

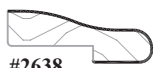

#2638
PC: M102
Sq Ft: .72
3/4"W
9/32"T



#2643
PC: M101
Sq Ft: .72
1 1/16"W
3/8"T



#2655
PC: M102
Sq Ft: .72
3/8"W
3/16"T



#2690
PC: M102
Sq Ft: .72
3/4"W
1/4"T

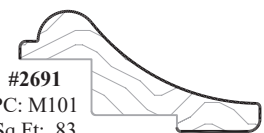

#2691
PC: M101
Sq Ft: .83
1 1/4"W
5/8"T



#2698
PC: M101
Sq Ft: .72
3/4"W
1 5/32"T

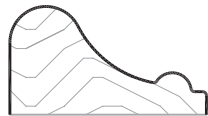

#2700
PC: M101
Sq Ft: .72
1 1/32"W
9/16"T

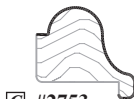

#2753
PC: M101
Sq Ft: .72
1/2"W
1 5/32"T



#2789-LF
PC: M102
Sq Ft: .72
1"W
1/4"T

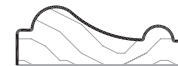

#2815
PC: M102
Sq Ft: .72
7/8"W
5/16"T



#2849-LF
PC: M102
Sq Ft: .72
7/32"W
1/4"T

C = Available for Convex/Concave products.

R = Available radiused to follow the contour of shaped rails.

► For PRICING ► See Section N.5 in our current Wholesale Pricing Catalog.

Applied Moldings - Inside Edge/Shelf/Face...continued

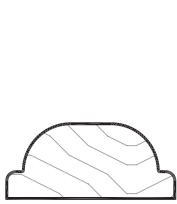

#2865
PC: M101
Sq Ft: .72
7/8"W
3/8"T

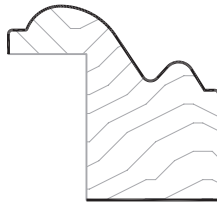

#2869
PC: M103
Sq Ft: .73
1 3/32"W
1"T



#2876
PC: M102
Sq Ft: .72
1 5/16"W
1/4"T

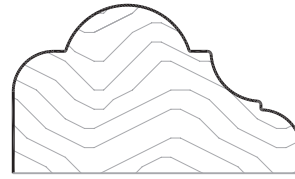

#2877
PC: M103
Sq Ft: 1.00
1 1/2"W
7/8"T

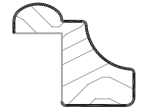

#2932
PC: M101
Sq Ft: .72
5/8"W
1 7/32"T



#2936
PC: M101
Sq Ft: 1.00
1 1/2"W
3/8"T

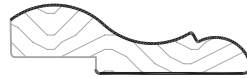

#2955
PC: M101
Sq Ft: .83
1 1/4"W
1 1/32"T

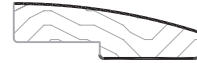

#2981
PC: M102
Sq Ft: .72
1"W
1/32"T

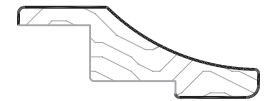

#2982
PC: M101
Sq Ft: .83
1 1/4"W
1 5/32"T

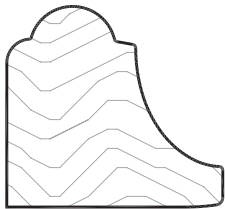

#3044
PC: M103
Sq Ft: .75
1 1/8"W
1 1/32"T



#3053
PC: M102
Sq Ft: .72
1 1/16"W
5/16"T

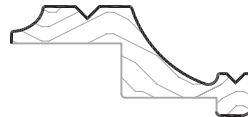

#3062
PC: M101
Sq Ft: .84
1 1/4"W
1/16"T

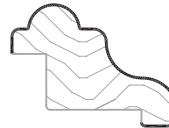

#3063
PC: M101
Sq Ft: .72
7/8"W
5/8"T

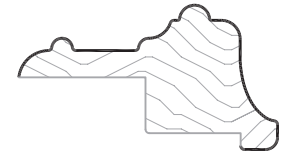

#3064
PC: M101
Sq Ft: .90
1 11/32"W
3/4"T

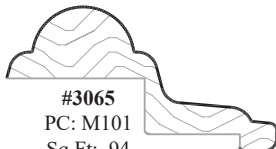

#3065
PC: M101
Sq Ft: .94
1 13/32"W
3/4"W

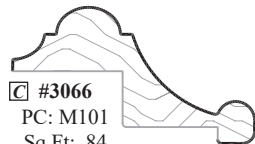

#3066
PC: M101
Sq Ft: .84
1 1/4"W
23/32"

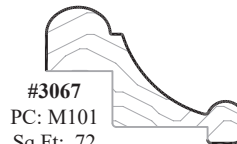

#3067
PC: M101
Sq Ft: .72
1 1/32"
23/32"T

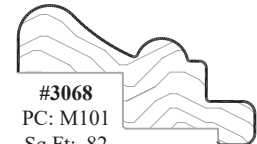

#3068
PC: M101
Sq Ft: .82
1 7/32"W
23/32"T

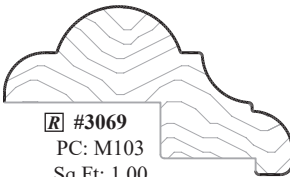

#3069
PC: M103
Sq Ft: 1.00
1 1/2"W
7/8"T

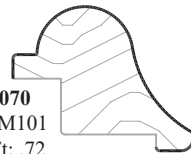

#3070
PC: M101
Sq Ft: .72
1 5/16"W
3/4"T



#3071
PC: M101
Sq Ft: .72
3/4"W
5/8"T



#3072
PC: M101
Sq Ft: .72
1"W
1 9/32"T

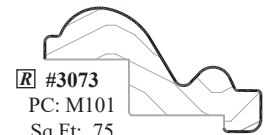

#3073
PC: M101
Sq Ft: .75
1 1/8"W
2 1/32"T

C = Available for Convex/Concave products. **R** = Available radiused to follow the contour of shaped rails.

► For PRICING ► See Section N.5 in our current Wholesale Pricing Catalog.

Applied Moldings - Inside Edge/Shelf/Face...continued



#3076
PC: M101
Sq Ft: .72
1⁵/₃₂"W
1¹/₃₂"T

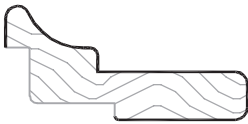

#3122
PC: M101
Sq Ft: .84
1¹/₄"W
1⁹/₃₂"T

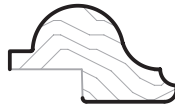

#3126
PC: M101
Sq Ft: .72
7⁷/₈"W
1¹/₂"T

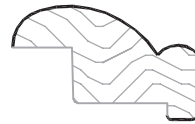

#3136
PC: M101
Sq Ft: .72
1"W
1⁹/₃₂"T

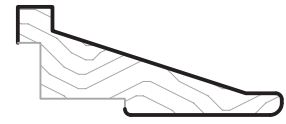

#3146
PC: M101
Sq Ft: .92
1³/₈"W
9¹/₁₆"T



#3147
PC: M101
Sq Ft: .72
1³/₁₆"W
3⁷/₈"T

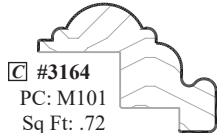

#3164
PC: M101
Sq Ft: .72
1⁵/₁₆"W
5⁷/₈"T



#3203
PC: M101
Sq Ft: .87
1⁵/₁₆"W
5⁷/₈"T

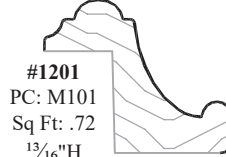

#1201
PC: M101
Sq Ft: .72
1³/₁₆"H
3¹/₃₂"T



#1849
PC: M101
Sq Ft: .72
1⁹/₃₂"H
2⁷/₃₂"T



#1198
PC: M101
Sq Ft: .72
1¹/₁₆"H
3³/₄"T



#1851
PC: M101
Sq Ft: .72
1⁷/₃₂"H
3³/₄"T



#1854
PC: M101
Sq Ft: .72
2¹/₃₂"H
3¹/₃₂"T



#1196
PC: M101
Sq Ft: .72
2¹/₃₂"H
1³/₁₆"T

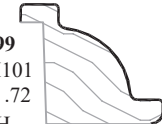

#1199
PC: M101
Sq Ft: .72
5⁷/₈"H
3³/₄"T

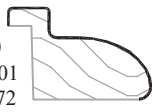

#1850
PC: M101
Sq Ft: .72
1⁵/₃₂"H
3³/₄"T

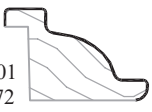

#1852
PC: M101
Sq Ft: .72
1⁵/₃₂"H
3³/₄"T



#1197
PC: M101
Sq Ft: .72
5⁷/₈"H
3³/₄"T



#1200
PC: M101
Sq Ft: .72
5⁷/₈"H
3³/₄"T



#1853
PC: M101
Sq Ft: .72
1⁵/₃₂"H
3³/₄"T

C = Available for Convex/Concave products. **R** = Available radiused to follow the contour of shaped rails.

► For PRICING ► See Section N.5 in our current Wholesale Pricing Catalog.

Old World Applied Moldings - Inside Edge/Shelf



#1330
PC: M101
Sq Ft: .72
7/8"W
13/16"T

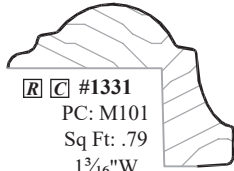

#1331
PC: M101
Sq Ft: .79
1 3/16"W
27/32"T

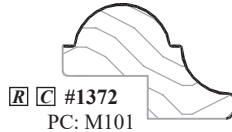

#1372
PC: M101
Sq Ft: .72
29/32"W
19/32"T

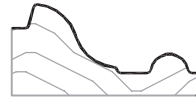

#1373
PC: M101
Sq Ft: .72
1"W
15/32"T

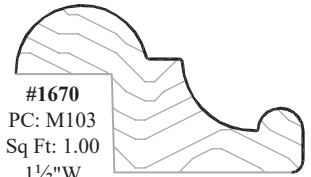

#1670
PC: M103
Sq Ft: 1.00
1 1/2"W
7/8"T

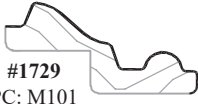

#1729
PC: M101
Sq Ft: .72
1"W
15/32"T



#1831
PC: M101
Sq Ft: .72
1"W
3/8"T



#1908
PC: M101
Sq Ft: .72
5/8"W
1/2"T

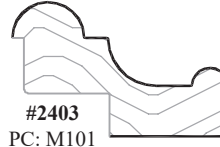

#2403
PC: M101
Sq Ft: .75
1 1/8"W
1 1/16"T

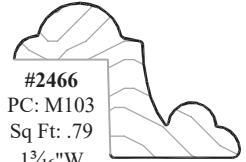

#2466
PC: M103
Sq Ft: .79
1 3/16"W
13/16"T



#2979
PC: M101
Sq Ft: .72
1/2"W
3/8"T

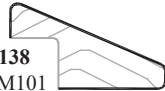

#3138
PC: M101
Sq Ft: .72
1 3/16"W
7/16"T

C = Available for Convex/Concave products. **R** = Available radiused to follow the contour of shaped rails.

Molding Options

Applied Molding

Applied Moldings - No-Panel Cut (NPC) Frame Only Doors

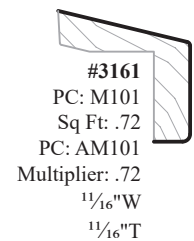
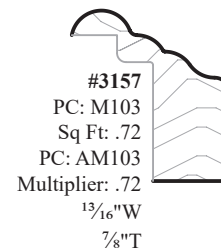
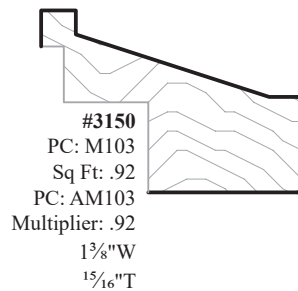
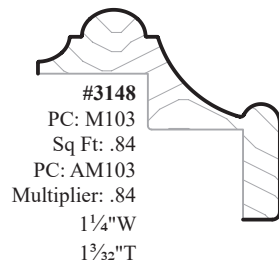
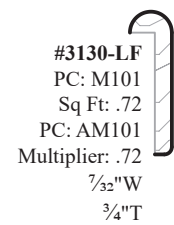
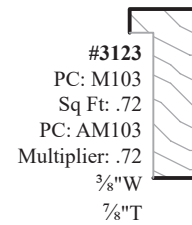
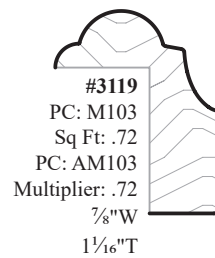
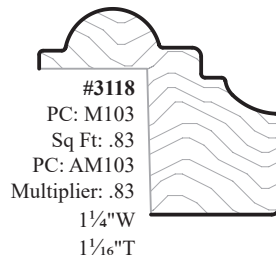
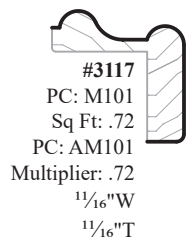
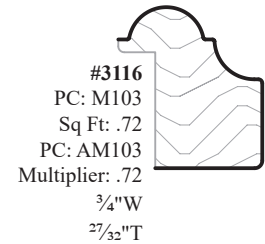
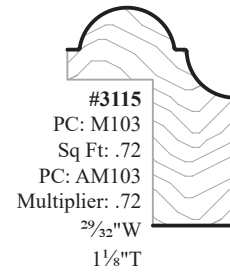
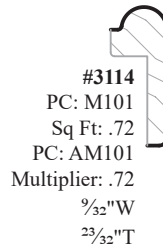
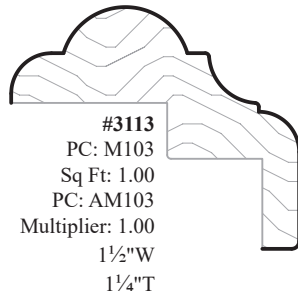
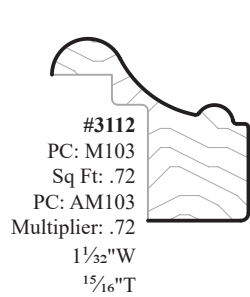
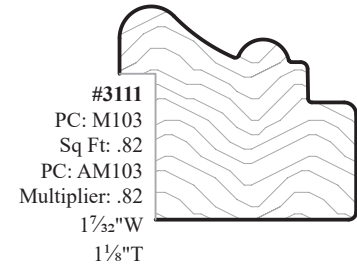
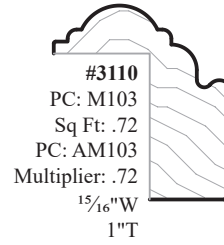
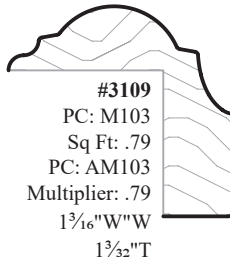
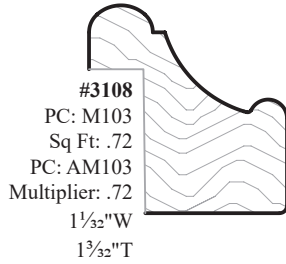
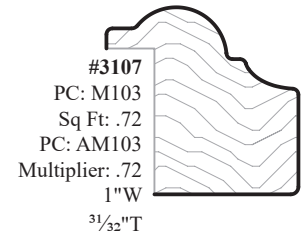
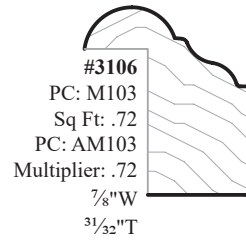
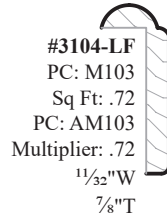
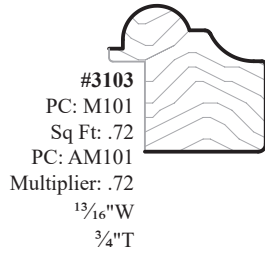
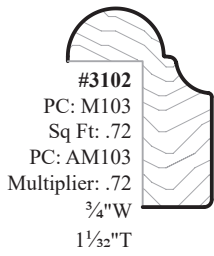





C = Available for Convex/Concave products.

R = Available radiused to follow the contour of shaped rails.

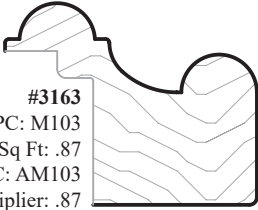
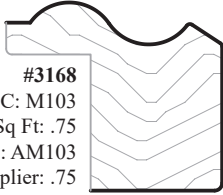
► For PRICING ► See Section N.5 in our current Wholesale Pricing Catalog.

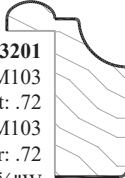
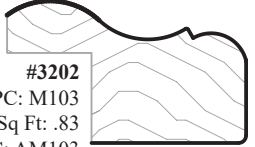
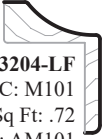
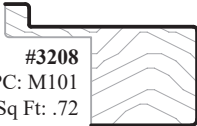
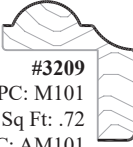
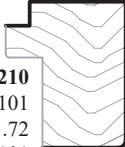
Applied Moldings - No-Panel Cut (NPC) Frame Only Doors

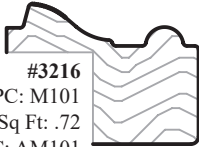
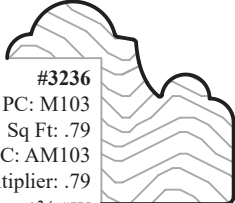
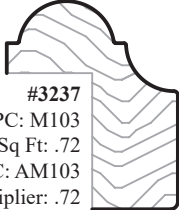
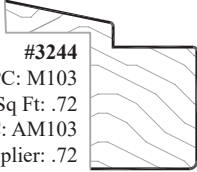
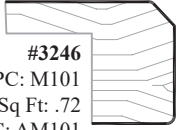
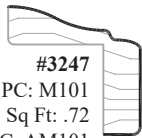
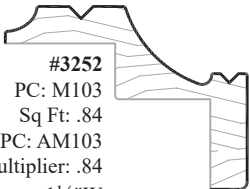
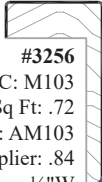
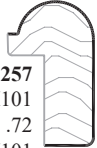
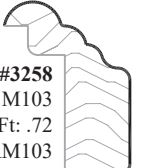
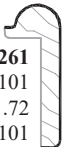
 <p>#3163 PC: M103 Sq Ft: .87 PC: AM103 Multiplier: .87 1 1/16"W 1 1/16"T</p>	 <p>#3168 PC: M103 Sq Ft: .75 PC: AM103 Multiplier: .75 1 1/8"W 3/32"T</p>	 <p>#3172-LF PC: M101 Sq Ft: .72 PC: AM101 Multiplier: .72 9/16"W 5/8"T</p>	 <p>#3201 PC: M103 Sq Ft: .72 PC: AM103 Multiplier: .72 5/8"W 29/32"T</p>	 <p>#3202 PC: M103 Sq Ft: .83 PC: AM103 Multiplier: .83 1 1/4"W 3/4"T</p>
 <p>#3204-LF PC: M101 Sq Ft: .72 PC: AM101 Multiplier: .72 1/2"W 1 1/16"T</p>	 <p>#3208 PC: M101 Sq Ft: .72 PC: AM101 Multiplier: .72 1"W 5/8"T</p>	 <p>#3209 PC: M101 Sq Ft: .72 PC: AM101 Multiplier: .72 1 1/16"W 23/32"T</p>	 <p>#3210 PC: M101 Sq Ft: .72 PC: AM101 Multiplier: .72 5/8"W 3/4"T</p>	 <p>#3211 PC: M101 Sq Ft: .72 PC: AM101 Multiplier: .72 1 1/16"W 13/16"T</p>
 <p>#3216 PC: M101 Sq Ft: .72 PC: AM101 Multiplier: .72 1"W 23/32"T</p>	 <p>#3236 PC: M103 Sq Ft: .79 PC: AM103 Multiplier: .79 1 3/16"W 1 1/16"T</p>	 <p>#3237 PC: M103 Sq Ft: .72 PC: AM103 Multiplier: .72 29/32"W 1 3/32"T</p>	 <p>#3244 PC: M103 Sq Ft: .72 PC: AM103 Multiplier: .72 1"W 7/8"T</p>	 <p>#3246 PC: M101 Sq Ft: .72 PC: AM101 Multiplier: .72 7/8"W 5/8"T</p>
 <p>#3247 PC: M101 Sq Ft: .72 PC: AM101 Multiplier: .72 1 1/16"W 2 1/32"T</p>	 <p>#3252 PC: M103 Sq Ft: .84 PC: AM103 Multiplier: .84 1 1/4"W 1 5/16"T</p>	 <p>#3256 PC: M103 Sq Ft: .72 PC: AM103 Multiplier: .84 1/2"W 1 5/16"T</p>	 <p>#3257 PC: M101 Sq Ft: .72 PC: AM101 Multiplier: .72 7/16"W 3/4"T</p>	 <p>#3258 PC: M103 Sq Ft: .72 PC: AM103 Multiplier: .72 2 1/32"W 7/8"T</p>
 <p>#3261 PC: M101 Sq Ft: .72 PC: AM101 Multiplier: .72 3/32"W 3/4"T</p>				

C = Available for Convex/Concave products. **R** = Available radiused to follow the contour of shaped rails.

► For PRICING ► See Section **N.5** in our current Wholesale Pricing Catalog.

Molding Options

Mullion Stock Molding

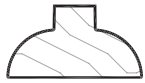

#812
PC: M101
Sq Ft: .72
1 1/16"W
3/8"T

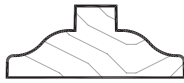

#813
PC: M101
Sq Ft: .72
1 5/16"W
3/8"T

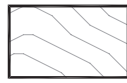

#814
PC: M101
Sq Ft: .72
5/8"W
3/8"T



#815
PC: M101
Sq Ft: .81
1 7/32"W
3/8"T

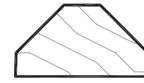

#816
PC: M101
Sq Ft: .72
1 1/16"W
3/8"T

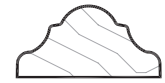

#818
PC: M101
Sq Ft: .72
3/4"W
3/8"T



#819
PC: M102
Sq Ft: .72
9/32"W
3/8"T

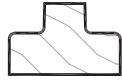

#880
PC: M101
Sq Ft: .72
1 9/32"W
3/8"H

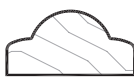

#914
PC: M102
Sq Ft: .72
2 1/32"W
1 1/32"T

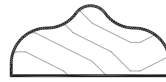

#939
PC: M101
Sq Ft: .72
2 7/32"W
3/8"T



#944
PC: M101
Sq Ft: .72
1 9/32"W
3/8"H

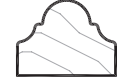

#948
PC: M101
Sq Ft: .72
1 7/32"W
1 3/32"T

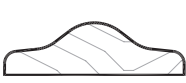

#949
PC: M102
Sq Ft: .72
1 5/16"W
9/32"T

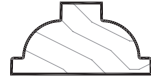

#955
PC: M101
Sq Ft: .72
2 3/32"W
3/8"T

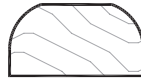

#956
PC: M101
Sq Ft: .72
1 1/16"W
3/8"T

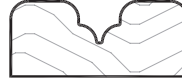

#957
PC: M101
Sq Ft: .72
1 5/16"W
1 3/32"T



#1037
PC: M101
Sq Ft: .72
3/8"W
3/8"T

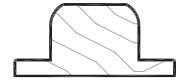

#1052
PC: M101
Sq Ft: .72
2 7/32"W
3/8"T

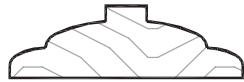

#1053
PC: M101
Sq Ft: .81
1 7/32"W
3/8"T

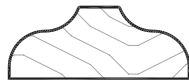

#1054
PC: M101
Sq Ft: .72
1 5/16"W
3/8"T



#1094
PC: M102
Sq Ft: .72
1"W
1 1/32"T

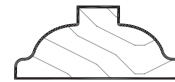

#1110
PC: M101
Sq Ft: .72
7/8"W
3/8"T



#1114
PC: M101
Sq Ft: .72
3 1/32"W
1 3/32"T

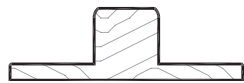

#1132
PC: M101
Sq Ft: .81
1 7/32"W
3/8"T



#1164
PC: M101
Sq Ft: .72
1 1/16"W
1 1/32"T



#1165
PC: M102
Sq Ft: .72
5/8"W
5/16"T



#1171
PC: M101
Sq Ft: .72
9/32"W
1 7/32"T



#1172
PC: M101
Sq Ft: .72
9/32"W
2 1/32"T



#1173
PC: M101
Sq Ft: .72
2 5/32"W
3/8"T



#1179
PC: M101
Sq Ft: .72
1 1/32"W
3/8"T



#1202
PC: M101
Sq Ft: .72
1 5/16"W
3/8"T



#1203
PC: M101
Sq Ft: .72
1 1/16"W
7/16"T

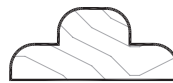

#1204
PC: M101
Sq Ft: .72
7/8"W
3/8"T

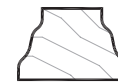

#1211
PC: M101
Sq Ft: .72
9/16"W
3/8"T

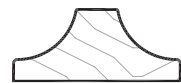

#1247
PC: M101
Sq Ft: .72
7/8"W
3/8"T

C = Available for Convex/Concave products. **R** = Available radiused to follow contour of shaped rails when used as applied molding.

► For PRICING ► See Section N.6 in our current Wholesale Pricing Catalog.

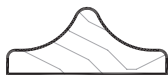

#1254
PC: M102
Sq Ft: .72
27/32"W
1 1/32"T



[R] #1260
PC: M101
Sq Ft: .72
25/32"W
3/8"T

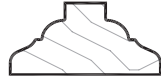

[R] #1263
PC: M101
Sq Ft: .72
25/32"W
3/8"T

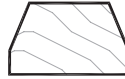

[R] #1265
PC: M101
Sq Ft: .72
5/8"W
3/8"T

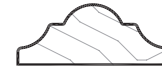

[R] [C] #1267
PC: M102
Sq Ft: .72
25/32"W
5/16"T



[R] #1268
PC: M101
Sq Ft: .72
25/32"W
3/8"T

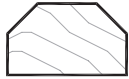

[R] #1269
PC: M101
Sq Ft: .72
5/8"W
3/8"T

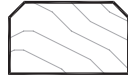

[R] #1274
PC: M101
Sq Ft: .72
5/8"W
3/8"T

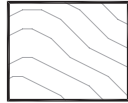

[R] #1303
PC: M101
Sq Ft: .72
5/8"W
1/2"T

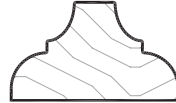

[R] #1304
PC: M101
Sq Ft: .72
7/8"W
1/2"T

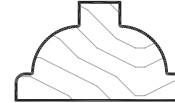

[R] #1305
PC: M101
Sq Ft: .72
7/8"W
1/2"T

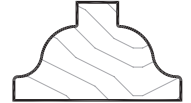

[R] #1306
PC: M101
Sq Ft: .72
7/8"W
1/2"T

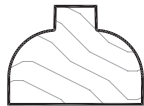

[R] #1307
PC: M101
Sq Ft: .72
1 1/16"W
1/2"T

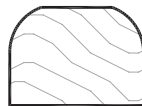

[R] #1322
PC: M101
Sq Ft: .72
1 1/16"W
1/2"T

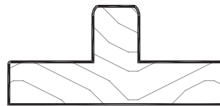

[R] #1333
PC: M101
Sq Ft: .75
1 1/8"W
1/2"T



#1343
PC: M101
Sq Ft: .72
9/32"W
3/4"T

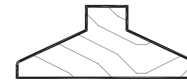

[R] #1351
PC: M101
Sq Ft: .72
15/16"W
3/8"T



[R] #1398
PC: M101
Sq Ft: .72
3/4"W
13/32"T



[R] #1628
PC: M101
Sq Ft: .72
7/8"W
1/2"

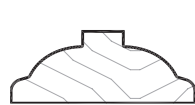

[R] #1666
PC: M101
Sq Ft: .72
3 1/32"W
3/8"T

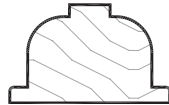

[R] #1695
PC: M101
Sq Ft: .72
27/32"W
1/2"T

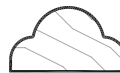

#1698
PC: M102
Sq Ft: .72
19/32"W
1 1/32"T

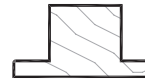

[R] #1732
PC: M101
Sq Ft: .72
3/4"W
3/8"T

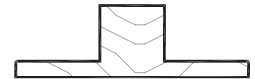

[R] #1733
PC: M101
Sq Ft: .81
1 1/32"W
3/8"T



#1776
PC: M101
Sq Ft: .81
17/32"W
3/32"T



[R] #1810
PC: M101
Sq Ft: .72
3/4"W
3/8"T



[R] [C] #1815
PC: M102
Sq Ft: .72
3/4"W
5/16"T



#1816
PC: M102
Sq Ft: .72
3/4"W
1/4"T



[R] #1821
PC: M101
Sq Ft: .72
3/4"W
3/8"T



#1841
PC: M101
Sq Ft: .72
7/8"W
3/8"T

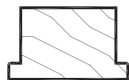

[R] #1863
PC: M101
Sq Ft: .72
5/8"W
3/8"T



#1866
PC: M101
Sq Ft: .72
19/32"W
13/32"T

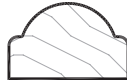

#1879
PC: M101
Sq Ft: .72
5/8"W
13/32"T



#1887
PC: M101
Sq Ft: .72
5/8"W
3/8"T

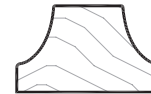

[R] #1895
PC: M101
Sq Ft: .72
3/4"W
7/16"T

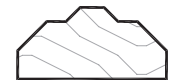

#1899
PC: M101
Sq Ft: .72
25/32"W
3/8"T

[C] = Available for Convex/Concave products. [R] = Available radiused to follow contour of shaped rails when used as applied molding.

► For PRICING ► See Section N.6 in our current Wholesale Pricing Catalog.

Molding Options

Mullion Stock Molding

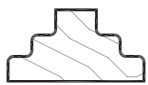

#1902
PC: M101
Sq Ft: .72
2³/₃₂"W
3¹/₈"T



#1911
PC: M101
Sq Ft: .72
3¹/₄"W
1³/₃₂"T



#1934
PC: M101
Sq Ft: .72
7¹/₈"W
1¹/₁₆"T



#1966
PC: M101
Sq Ft: .72
7¹/₈"W
1¹/₂"T

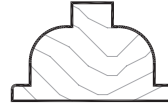

#1967
PC: M101
Sq Ft: .72
2⁷/₃₂"W
1¹/₂"T



#1971
PC: M101
Sq Ft: .72
2³/₃₂"W
3¹/₈"T



#1998
PC: M102
Sq Ft: .72
3¹/₄"W
1¹/₄"T

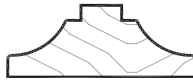

#2006
PC: M101
Sq Ft: .72
3¹/₃₂"W
3¹/₈"T



#2008
PC: M102
Sq Ft: .72
3¹/₄"W
9¹/₃₂"T



#2009
PC: M102
Sq Ft: .81
1¹/₃₂"W
9¹/₃₂"T

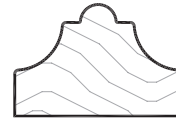

#2014
PC: M101
Sq Ft: .72
7¹/₈"W
1⁹/₃₂"T

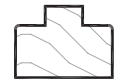

#2015
PC: M101
Sq Ft: .72
1¹/₂"W
3¹/₈"T



#2016
PC: M101
Sq Ft: .72
2⁷/₃₂"W
1¹/₃₂"T

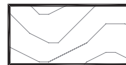

#2018
PC: M102
Sq Ft: .72
5¹/₈"W
5¹/₁₆"T



#2038
PC: M101
Sq Ft: .72
1¹³/₁₆"W
1¹³/₃₂"T



#2043
PC: M102
Sq Ft: .72
3¹/₄"W
5¹/₃₂"T



#2044
PC: M101
Sq Ft: .72
3¹/₄"W
3¹/₈"T

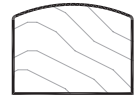

#2061
PC: M101
Sq Ft: .72
5¹/₈"W
1¹/₃₂"T

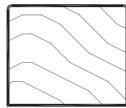

#2062
PC: M101
Sq Ft: .72
5¹/₈"W
1⁷/₃₂"T



#2063
PC: M101
Sq Ft: .72
5¹/₈"W
1¹⁷/₃₂"T



#2099
PC: M101
Sq Ft: .72
3¹/₄"W
1¹³/₃₂"T



#2146
PC: M102
Sq Ft: .72
2⁵/₃₂"W
5¹/₁₆"T



#2148
PC: M101
Sq Ft: .72
2⁹/₃₂"W
3¹/₈"T

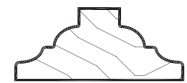

#2149
PC: M101
Sq Ft: .72
7¹/₈"W
3¹/₈"T

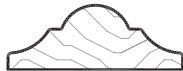

#2194
PC: M102
Sq Ft: .72
2⁹/₃₂"W
1¹/₃₂"T

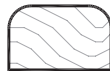

#2296
PC: M101
Sq Ft: .72
1⁷/₃₂"W
1¹/₃₂"T



#2298
PC: M102
Sq Ft: .72
9¹/₁₆"W
7¹/₃₂"T



#2314
PC: M102
Sq Ft: .72
3¹/₄"W
3¹/₁₆"T



#2324
PC: M101
Sq Ft: .86
1¹/₃₂"W
1¹³/₃₂"T



#2325
PC: M101
Sq Ft: .72
1¹/₁₆"W
1¹³/₃₂"T



#2370
PC: M101
Sq Ft: .72
1⁷/₃₂"W
1¹³/₃₂"T



#2375
PC: M101
Sq Ft: .72
1¹⁵/₁₆"W
1¹³/₃₂"T



#2376
PC: M101
Sq Ft: .72
1¹⁵/₁₆"T
1¹/₃₂"T



#2377
PC: M101
Sq Ft: .72
1"W
1¹⁵/₃₂"T



#2380
PC: M101
Sq Ft: .81
1⁷/₃₂"W
3¹/₈"T



#2384
PC: M101
Sq Ft: .72
1¹/₁₆"W
1¹³/₃₂"T

C = Available for Convex/Concave products. **R** = Available radiused to follow contour of shaped rails when used as applied molding.

► For PRICING ► See Section N.6 in our current Wholesale Pricing Catalog.

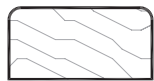

#2399
PC: M101
Sq Ft: .72
3/4"W
3/8"T

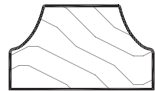

#2406
PC: M101
Sq Ft: .72
3/4"W
1/16"T

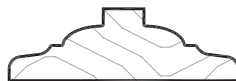

#2407
PC: M101
Sq Ft: .80
13/16"W
3/8"T



#2408
PC: M101
Sq Ft: .72
5/8"W
1 1/32"T

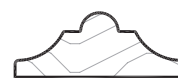

#2409
PC: M101
Sq Ft: .72
7/8"W
1 1/32"T



#2437
PC: M101
Sq Ft: .72
1 1/16"W
1 1/32"T



#2438
PC: M102
Sq Ft: .72
3 1/32"W
3/32"T

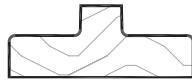

#2439
PC: M101
Sq Ft: .72
3 1/32"W
3/8"T



#2452
PC: M102
Sq Ft: .72
3/4"W
1/4"T

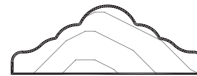

#2463
PC: M101
Sq Ft: .72
1"W
1 1/32"T

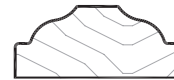

#2469
PC: M101
Sq Ft: .72
7/8"W
3/8"T



#2472
PC: M102
Sq Ft: .72
2 3/32"W
7/32"T



#2473
PC: M101
Sq Ft: .72
2 9/32"W
3/8"T



#2474
PC: M101
Sq Ft: .72
2 3/32"W
1 3/32"T



#2493
PC: M101
Sq Ft: .72
3 1/32"W
3/8"T



#2494
PC: M101
Sq Ft: .97
1 1 1/32"W
3/8"T

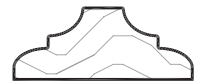

#2495
PC: M101
Sq Ft: .72
1 5/16"W
3/8"T



#2504
PC: M101
Sq Ft: .72
3 1/32"W
3/8"T

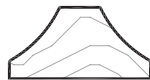

#2506
PC: M101
Sq Ft: .72
3/4"W
3/8"T

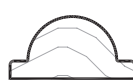

#2507
PC: M101
Sq Ft: .72
2 1/32"W
1 1/32"T



#2512
PC: M101
Sq Ft: .72
2 7/32"W
1 1/32"T



#2513
PC: M101
Sq Ft: .72
1 9/32"W
1 1/32"T



#2514
PC: M101
Sq Ft: .72
7/8"W
1 3/32"T



#2527
PC: M101
Sq Ft: .72
3/4"W
3/32"T



#2551
PC: 101
Sq Ft: .72
1 1/16"W
1 1/32"T



#2552
PC: M101
Sq Ft: .72
1 1/32"W
3/8"T



#2557
PC: M101
Sq Ft: .83
1 1/4"W
1 3/32"T



#2581
PC: M102
Sq Ft: .72
5/8"W
1/4"T



#2582
PC: M102
Sq Ft: .72
3/4"W
3/32"T



#2587
PC: M101
Sq Ft: .81
1 7/32"W
1/2"T



#2589
PC: M101
Sq Ft: .72
1"W
1 3/32"T



#2590
PC: M101
Sq Ft: .72
3/4"W
3/8"T



#2591
PC: M102
Sq Ft: .72
5/8"W
3/32"T



#2595
PC: M101
Sq Ft: .72
3/4"W
1 1/32"T



#2607
PC: M102
Sq Ft: .72
5/8"W
3/16"T

[C] = Available for Convex/Concave products. [R] = Available radiused to follow contour of shaped rails when used as applied molding.

► For PRICING ► See Section N.6 in our current Wholesale Pricing Catalog.

Molding Options

Mullion Stock Molding



#2611
PC: M101
Sq Ft: .72
1¹/₃₂"W
1³/₃₂"T



#2619
PC: M101
Sq Ft: .72
5/8"W
1¹/₃₂"T

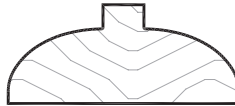

#2642
PC: M101
Sq Ft: .80
1³/₁₆"W
1/2"T



#2668
PC: M101
Sq Ft: .72
2³/₃₂"W
3/8"T

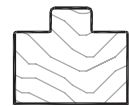

#2669
PC: M101
Sq Ft: .72
1⁹/₃₂"W
1/2"T

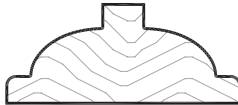

#2672
PC: M101
Sq Ft: .81
1⁷/₃₂"W
1/2"T



#2673
PC: M101
Sq Ft: .81
1⁷/₃₂"W
3/8"T

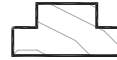

#2759
PC: M102
Sq Ft: .72
1/16"W
3/32"T



#2760
PC: M102
Sq Ft: .83
1¹/₄"W
3/16"T

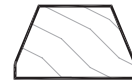

#2761
PC: M101
Sq Ft: .72
5/8"W
3/8"T



#2784
PC: M101
Sq Ft: .72
1"W
3/8"T



#2785
PC: M101
Sq Ft: .72
3¹/₃₂"W
3/8"T

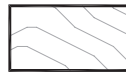

#2793
PC: M101
Sq Ft: .72
5/8"W
1¹/₃₂"T



#2798
PC: M102
Sq Ft: .72
3/8"W
1/4"T



#2799
PC: M101
Sq Ft: .83
1¹/₄"W
7/16"T



#2813
PC: M101
Sq Ft: .72
2³/₃₂"W
3/8"T



#2840
PC: M102
Sq Ft: .72
1/16"W
3/32"T



#2842
PC: M101
Sq Ft: .72
5/8"W
1/2"T

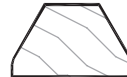

#2843
PC: M101
Sq Ft: .72
5/8"W
3/8"T

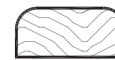

#2850
PC: M102
Sq Ft: .72
1/16"W
1/4"T



#2851
PC: M102
Sq Ft: .72
5/8"W
1/4"T

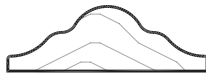

#2881
PC: M101
Sq Ft: .72
1¹/₃₂"W
1¹/₃₂"T

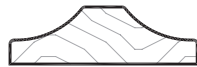

#2892
PC: M102
Sq Ft: .72
3¹/₃₂"W
1/16"T

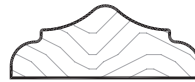

#2900
PC: M101
Sq Ft: .72
3¹/₃₂"W
3/8"T

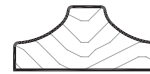

#2901
PC: M101
Sq Ft: .72
3/4"W
1¹/₃₂"T

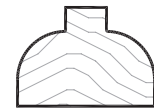

#2909
PC: M101
Sq Ft: .72
2³/₃₂"W
1/2"T



#2911
PC: M101
Sq Ft: .72
5/8"W
3/32"T



#2925
PC: M101
Sq Ft: .89
1¹/₃₂"W
1/2"T

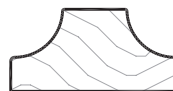

#2926
PC: M101
Sq Ft: .72
7/8"W
1/16"T



#2951
PC: M102
Sq Ft: .72
3/32"W
1/4"T



#2956
PC: M101
Sq Ft: .72
3/4"W
1¹/₃₂"T

[C] = Available for Convex/Concave products. **[R]** = Available radiused to follow contour of shaped rails when used as applied molding.

► For PRICING ► See Section N.6 in our current Wholesale Pricing Catalog.

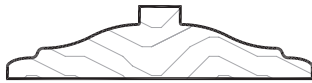

#2957
PC: M101
Sq Ft: 1.06
1¹⁹/₃₂"W
3/8"T



#2983
PC: M101
Sq Ft: .72
2⁷/₃₂"W
1¹/₃₂"T



#2984
PC: M101
Sq Ft: .72
1¹/₃₂"W
1⁹/₃₂"T

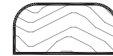

#2985
PC: M102
Sq Ft: .72
1⁷/₃₂"W
1/4"T



#2986
PC: M101
Sq Ft: .72
2³/₃₂"W
1¹/₃₂"T



#2987
PC: M101
Sq Ft: .72
5/8"W
1³/₃₂"T



#2988
PC: M101
Sq Ft: .72
2⁷/₃₂"W
1³/₃₂"T



#3037
PC: M101
Sq Ft: .72
3/4"W
5/16"T



#3038
PC: M102
Sq Ft: .72
1/2"W
3/32"T



#3039
PC: M101
Sq Ft: .72
3/4"W
1¹/₃₂"T



#3054
PC: M101
Sq Ft: .72
3¹/₃₂"W
3/8"T



#3074
PC: M101
Sq Ft: 1.06
1¹⁹/₃₂"W
3/8"T



#3087
PC: M102
Sq Ft: .72
5/8"W
7/32"T

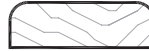

#3088
PC: M102
Sq Ft: .72
3/4"W
1/4"T

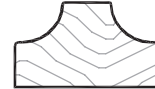

#3120
PC: M101
Sq Ft: .72
3/4"W
7/16"T



#3129
PC: M101
Sq Ft: .72
5/8"W
1³/₃₂"T

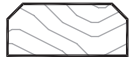

#3140
PC: M101
Sq Ft: .72
5/8"W
3/32"T



#3152
PC: M102
Sq Ft: .72
5/8"W
3/16"T



#3159
PC: M101
Sq Ft: .72
2³/₃₂"W
1/4"T



#3169
PC: M101
Sq Ft: .81
1⁷/₃₂"W
1/2"T

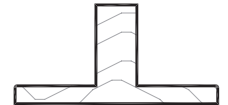

#3195
PC: M101
Sq Ft: .72
1¹/₁₆"W
1/2"T



#3196
PC: M101
Sq Ft: .72
2³/₃₂"W
1/2"T



#3260
PC: M102
Sq Ft: .72
5/8"W
1/4"T



#3262
PC: M102
Sq Ft: .72
5/8"W
7/32"T

[C] = Available for Convex/Concave products. [R] = Available radiused to follow contour of shaped rails when used as applied molding.

► For PRICING ► See Section [N.6](#) in our current Wholesale Pricing Catalog.

Molding Options

Column Molding

Half & Quarter Round Column Moldings - Smooth

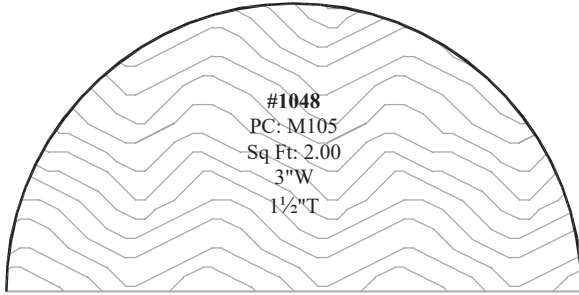

#1048
PC: M105
Sq Ft: 2.00
3"W
1½"T

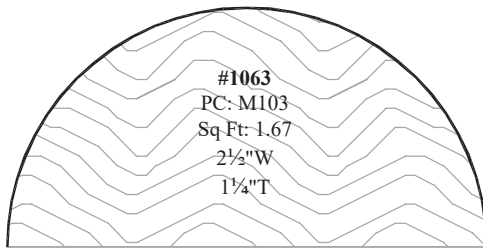

#1063
PC: M103
Sq Ft: 1.67
2½"W
1¼"T

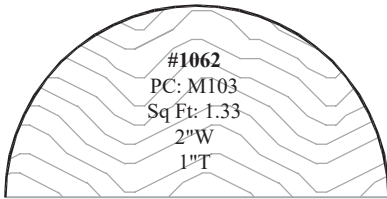

#1062
PC: M103
Sq Ft: 1.33
2"W
1"T

#1061
PC: M101
Sq Ft: 1.00
1½"W
¾"T

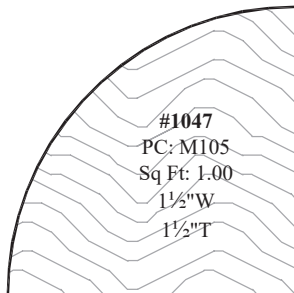
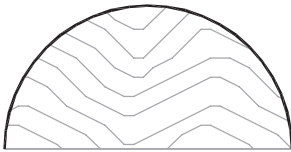

#1047
PC: M105
Sq Ft: 1.00
1½"W
1½"T

Half Round Column Moldings - Reed

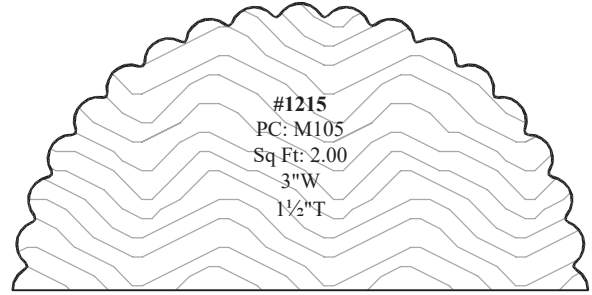

#1215
PC: M105
Sq Ft: 2.00
3"W
1½"T

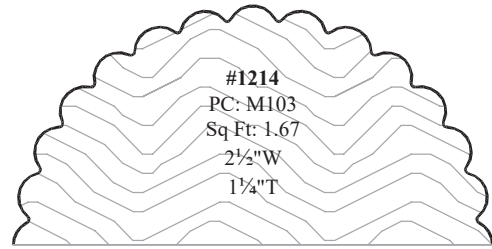

#1214
PC: M103
Sq Ft: 1.67
2½"W
1¼"T

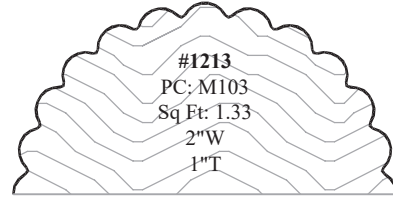

#1213
PC: M103
Sq Ft: 1.33
2"W
1"T

#1212
PC: M101
Sq Ft: 1.00
1½"W
¾"T



► For PRICING ► See Section N.7 in our current Wholesale Pricing Catalog.

Column Molding

Molding Options

Half & Quarter Round Column Moldings - Large Flutes

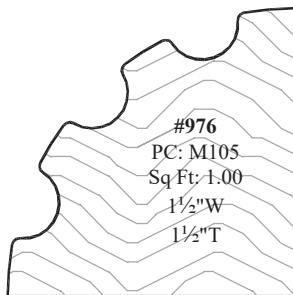
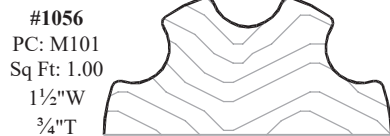
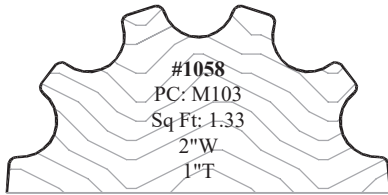
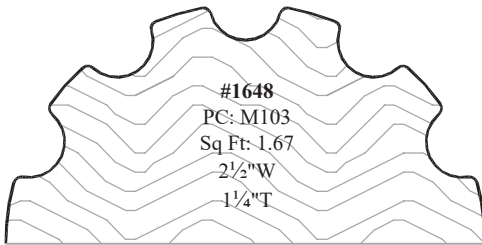
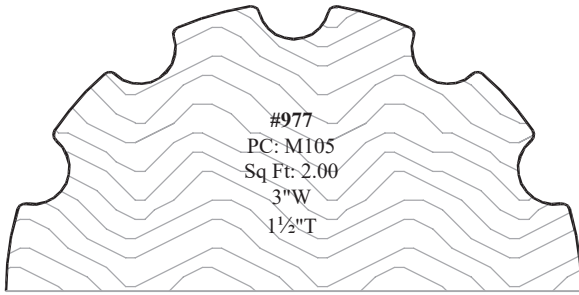

Half & Quarter Round Column Moldings - Small Flutes

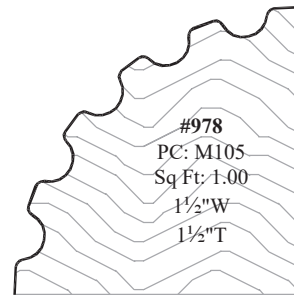
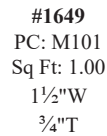
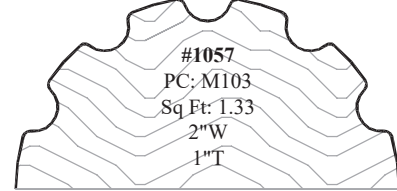
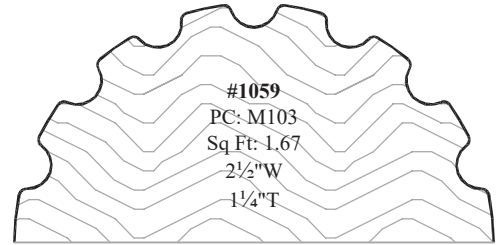
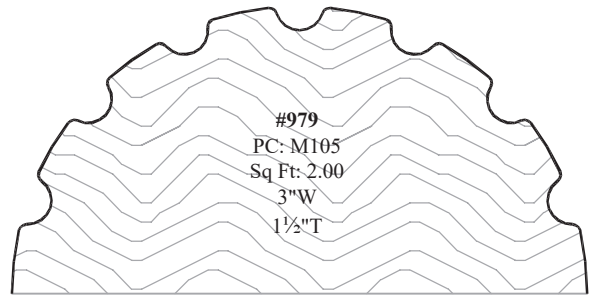

► For PRICING ► See Section N.7 in our current Wholesale Pricing Catalog.

1/4" Beaded Column Moldings

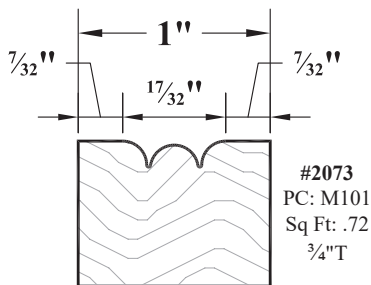
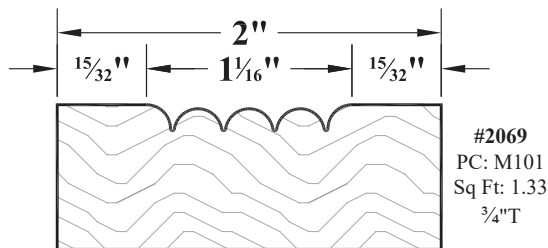
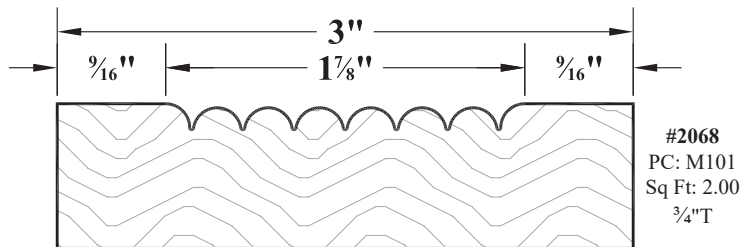
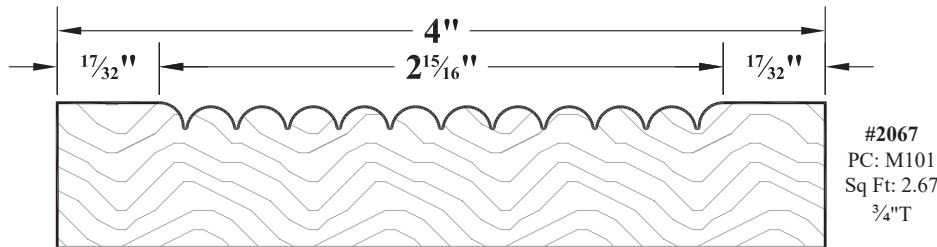
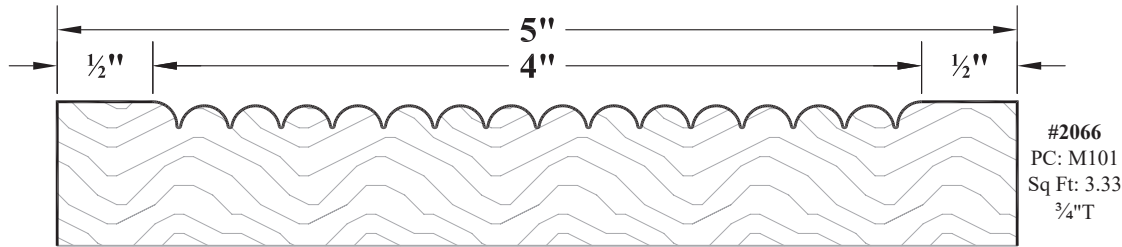
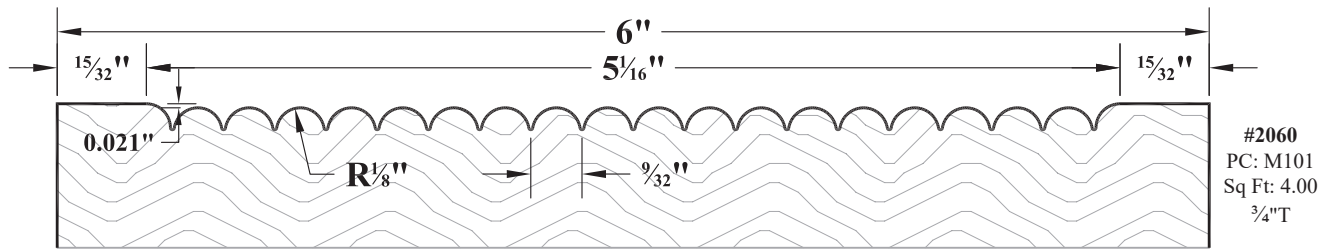

► For PRICING ► See Section N.7 in our current Wholesale Pricing Catalog.

3/8" Beaded Column Moldings

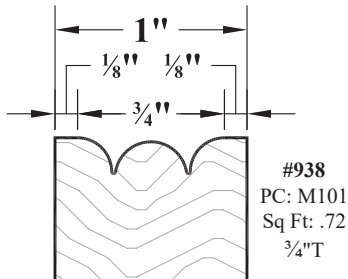
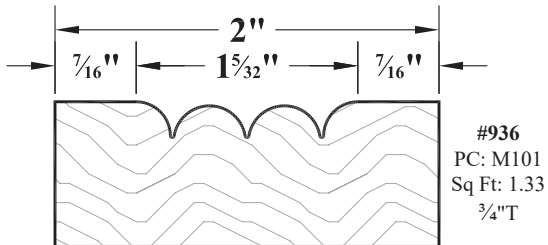
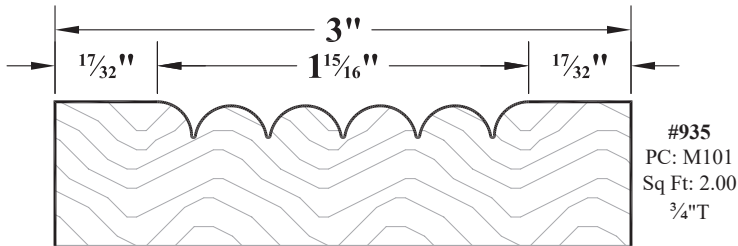
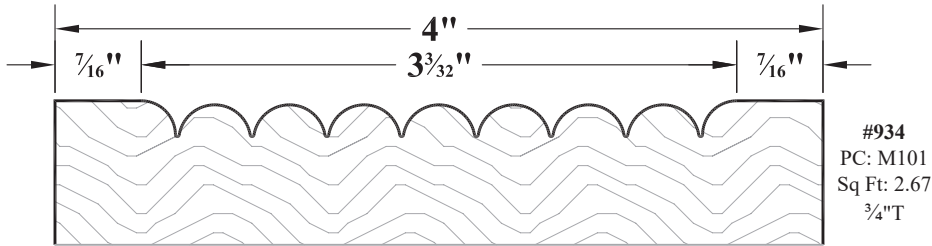
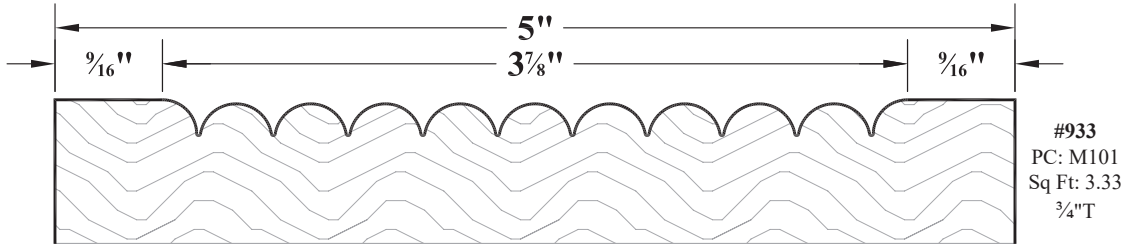
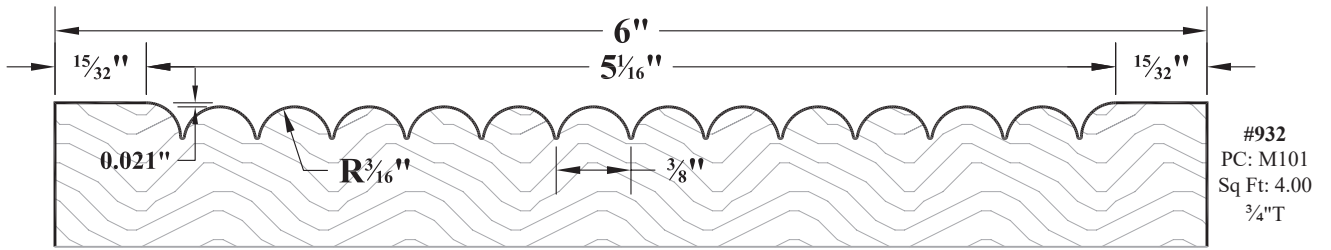

N

► For PRICING ► See Section N.7 in our current Wholesale Pricing Catalog.

Elliptical Column Moldings

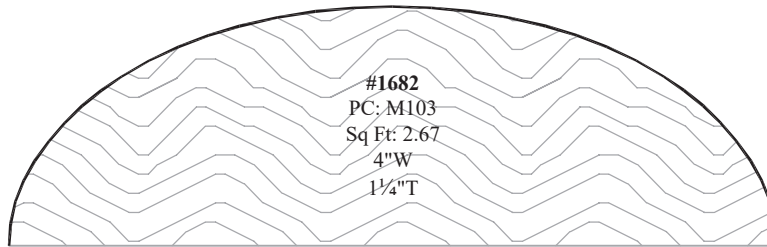
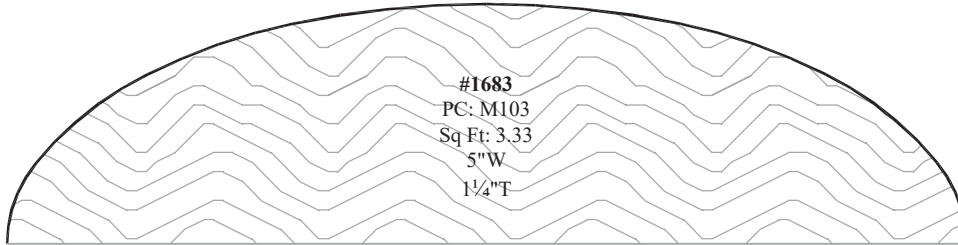
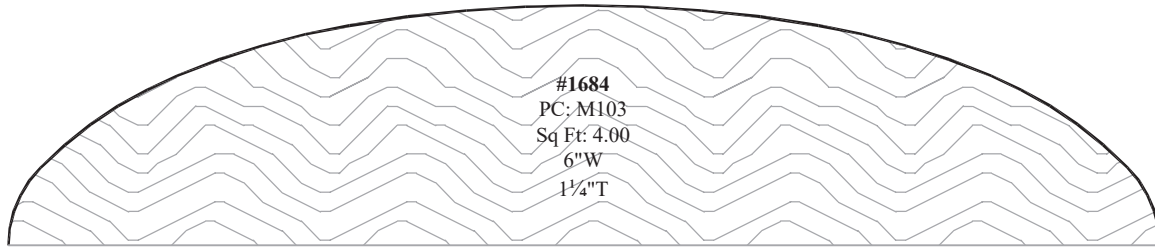

Pyramid Column Moldings

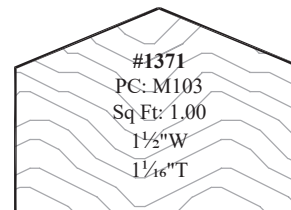
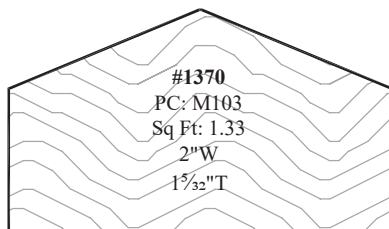
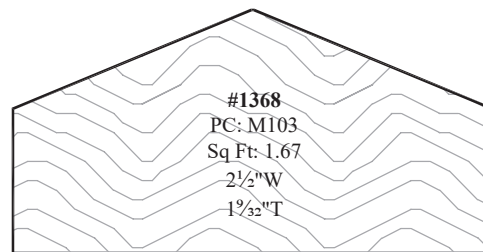
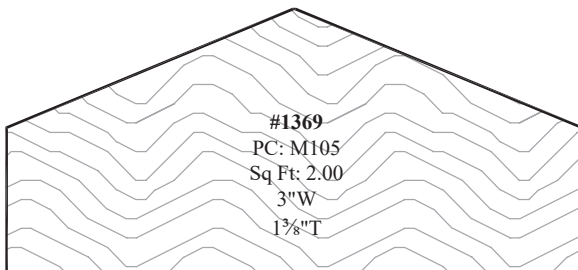

► For PRICING ► See Section N.7 in our current Wholesale Pricing Catalog.

Reed Column Moldings

#2860
PC: M101
Sq Ft: 1.5
2 1/4"W
3/4"T

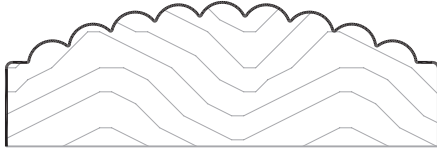

#2330
PC: M101
Sq Ft: 1.50
2 1/4"W
3/4"T



#2306
PC: M101
Sq Ft: 1.50
2 1/4"W
3/4"T



Miscellaneous Column Molding

#2283
PC: M103
Sq Ft: 2.00
3"W
1"T

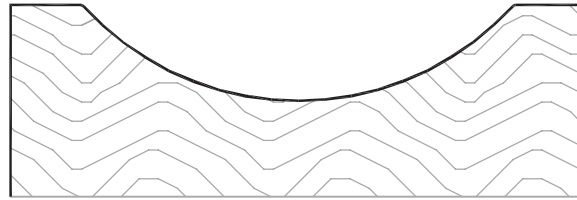

N

► For PRICING ► See Section N.7 in our current Wholesale Pricing Catalog.

Round Column Wrap Moldings - Smooth Face

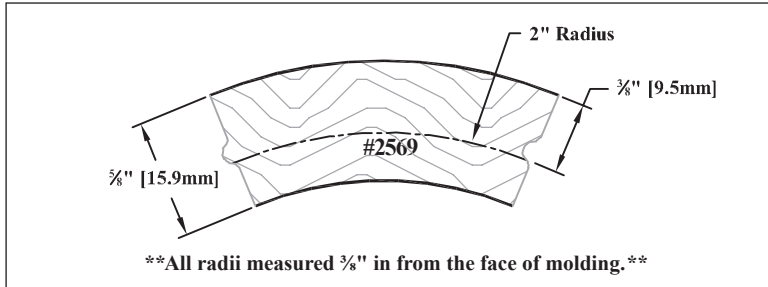
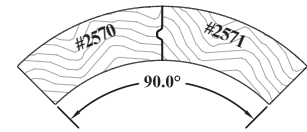
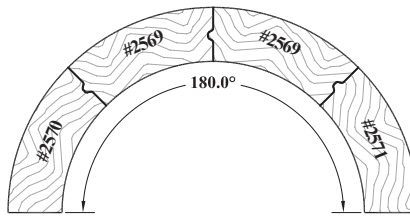
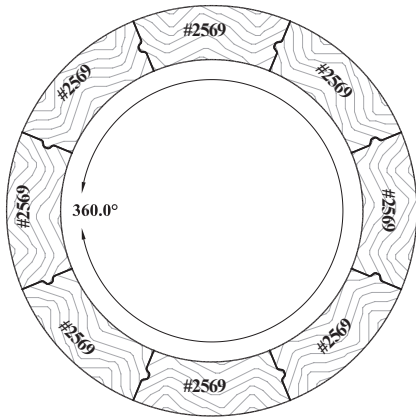

Note: Application drawings not shown at full scale.

Column Wrap Applications	Number of Moldings Required							
	2" Radius [50.8mm]	3" Radius [76.2mm]	4" Radius [101.6mm]	5" Radius [127mm]	6" Radius [152.4mm]	7" Radius [177.8mm]	8" Radius [203.2mm]	9" Radius [228.6mm]
Curve in Degrees								
45°	1	2	2	2	2	2	3	3
90°	2	4	4	4	4	4	6	6
135°	3	6	6	6	6	6	9	9
180°	4	8	8	8	8	8	12	12
225°	5	10	10	10	10	10	15	15
270°	6	12	12	12	12	12	18	18
315°	7	14	14	14	14	14	21	21
360°	8	16	16	16	16	16	24	24
Inside Diameter (I.D.)	3 1/2" [88.9mm]	5 1/2" [139.7mm]	7 1/2" [190.5mm]	9 1/2" [241.3mm]	11 1/2" [292.1mm]	13 1/2" [342.9mm]	15 1/2" [393.7mm]	17 1/2" [444.5mm]
Outside Diameter (O.D.)	4 3/4" [120.7mm]	6 3/4" [171.5mm]	8 3/4" [222.3mm]	10 3/4" [273.1mm]	12 3/4" [323.9mm]	14 3/4" [374.7mm]	16 3/4" [425.5mm]	18 3/4" [476.3mm]

2" Radius - Smooth Face

#2570
PC: M101
Sq Ft: 1.21
1 13/16"W
3/4"T

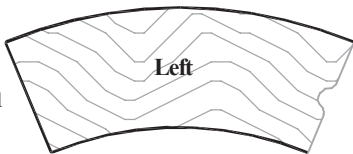

#2569
PC: M101
Sq Ft: 1.21
1 13/16"W
3/4"T

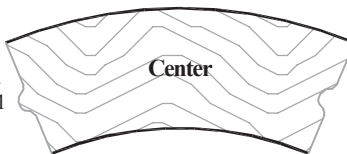

#2571
PC: M101
Sq Ft: 1.21
1 13/16"W
3/4"T

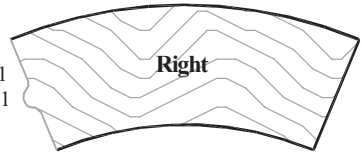

3" Radius - Smooth Face

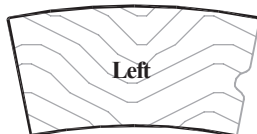

#2567
PC: M101
Sq Ft: .88
1 5/16"W
1/16"T

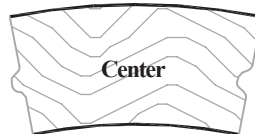

#2566
PC: M101
Sq Ft: .88
1 5/16"W
1/16"T

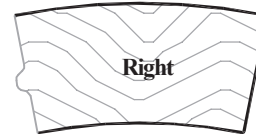

#2568
PC: M101
Sq Ft: .88
1 5/16"W
1/16"T

► For PRICING ► See Section N.7 in our current Wholesale Pricing Catalog.

Column Molding

Molding Options

4" Radius - Smooth Face

#2574
PC: M101
Sq Ft: 1.14
1²³/₃₂"W
1¹/₁₆"T

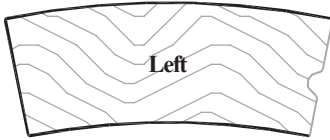

Left

#2573
PC: M101
Sq Ft: 1.14
1²³/₃₂"W
1¹/₁₆"T

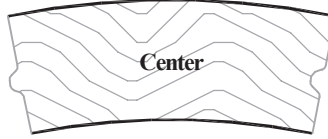

Center

#2575
PC: M101
Sq Ft: 1.14
1²³/₃₂"W
1¹/₁₆"T

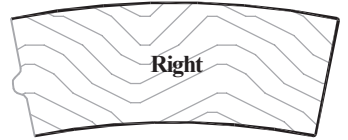

Right

5" Radius - Smooth Face



Left

#2532
PC: M101
Sq Ft: 1.40
2³/₃₂"W
2³/₃₂"T

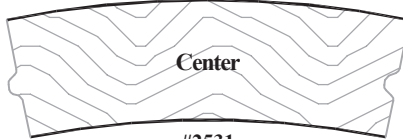

Center

#2531
PC: M101
Sq Ft: 1.40
2³/₃₂"W
2³/₃₂"T

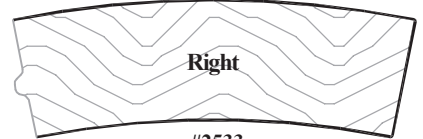

Right

#2533
PC: M101
Sq Ft: 1.40
2³/₃₂"W
2³/₃₂"T

6" Radius - Smooth Face

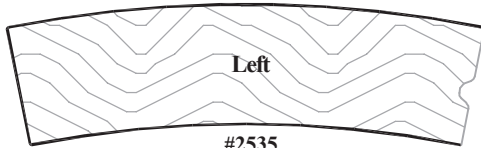

Left

#2535
PC: M101
Sq Ft: 1.66
2¹/₂"W
3³/₄"T

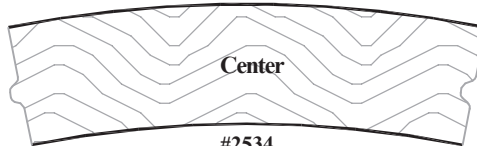

Center

#2534
PC: M101
Sq Ft: 1.66
2¹/₂"W
3³/₄"T

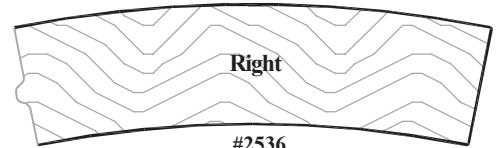

Right

#2536
PC: M101
Sq Ft: 1.66
2¹/₂"W
3³/₄"T

7" Radius - Smooth Face

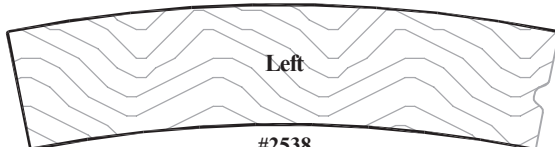

Left

#2538
PC: M101
Sq Ft: 1.92
2⁷/₈"W
3³/₄"T

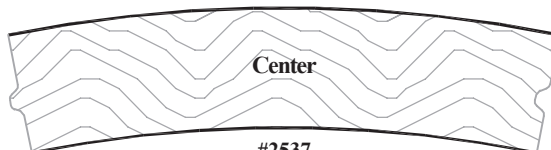

Center

#2537
PC: M101
Sq Ft: 1.92
2⁷/₈"W
3³/₄"T



Right

#2539
PC: M101
Sq Ft: 1.92
2⁷/₈"W
3³/₄"T

► For PRICING ► See Section N.7 in our current Wholesale Pricing Catalog.

8" Radius - Smooth Face

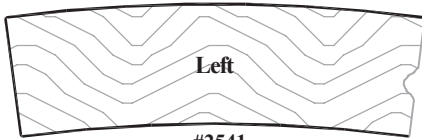

#2541
 PC: M101
 Sq Ft: 1.46
 2³/₁₆"W
 1¹/₁₆"T

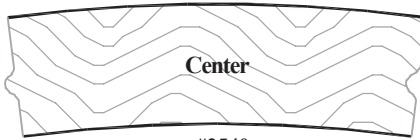

#2540
 PC: M101
 Sq Ft: 1.47
 2³/₁₆"W
 1¹/₁₆"T



#2542
 PC: M101
 Sq Ft: 1.47
 2³/₁₆"W
 1¹/₁₆"T

9" Radius - Smooth Face

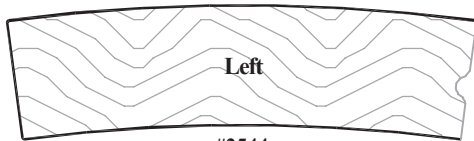

#2544
 PC: M101
 Sq Ft: 1.63
 2⁷/₁₆"W
 1¹/₁₆"T

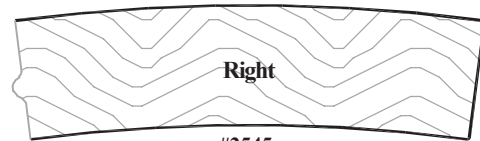

#2545
 PC: M101
 Sq Ft: 1.64
 2¹⁵/₃₂"W
 1¹/₁₆"T

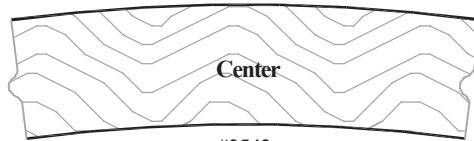

#2543
 PC: M101
 Sq Ft: 1.64
 2¹⁵/₃₂"W
 1¹/₁₆"T

N

► **For PRICING** ► See Section N.7 in our current Wholesale Pricing Catalog.

Round Column Wrap Moldings - Fluted Face

Note: These application drawings are not drawn to scale.

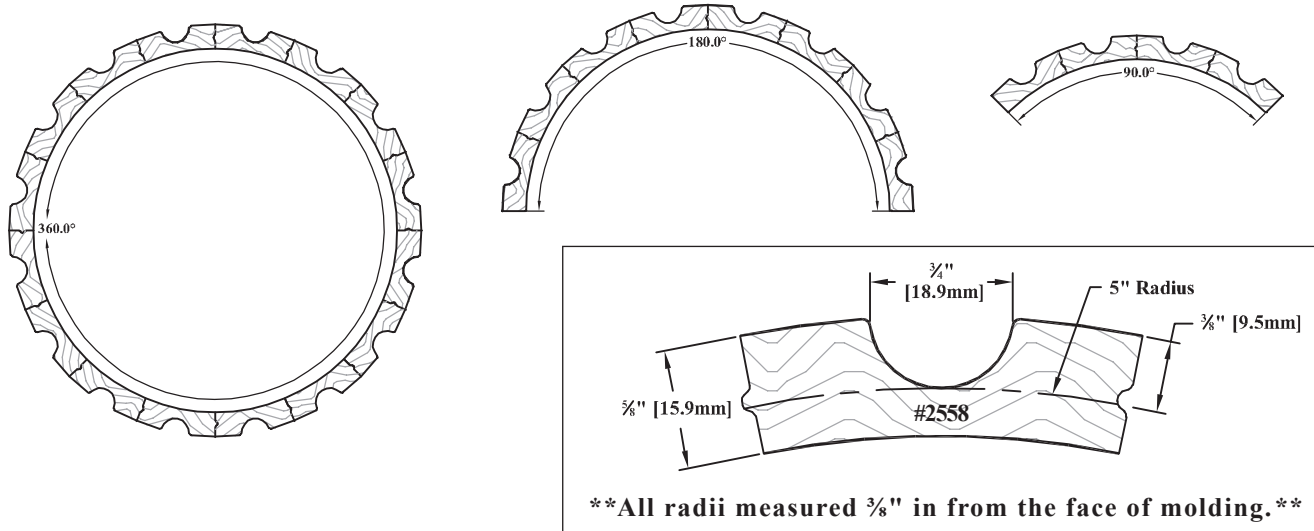

All radii measured 3/8" in from the face of molding.

Column Wrap Applications	Number of Moldings Required								
	2" Radius [50.8mm]	3" Radius [76.2mm]	4" Radius [101.6mm]	5" Radius [127mm]	6" Radius [152.4mm]	7" Radius [177.8mm]	8" Radius [203.2mm]	9" Radius [228.6mm]	
45°	1	2	2	2	2	2	3	3	
90°	2	4	4	4	4	4	6	6	
135°	3	6	6	6	6	6	9	9	
180°	4	8	8	8	8	8	12	12	
225°	5	10	10	10	10	10	15	15	
270°	6	12	12	12	12	12	18	18	
315°	7	14	14	14	14	14	21	21	
360°	8	16	16	16	16	16	24	24	
Inside Diameter (I.D.)	3 1/2" [88.9mm]	5 1/2" [139.7mm]	7 1/2" [190.5mm]	9 1/2" [241.3mm]	11 1/2" [292.1mm]	13 1/2" [342.9mm]	15 1/2" [393.7mm]	17 1/2" [444.5mm]	
Outside Diameter (O.D.)	4 3/4" [120.7mm]	6 3/4" [171.5mm]	8 3/4" [222.3mm]	10 3/4" [273.1mm]	12 3/4" [323.9mm]	14 3/4" [374.7mm]	16 3/4" [425.5mm]	18 3/4" [476.3mm]	

2" Radius - Fluted Face

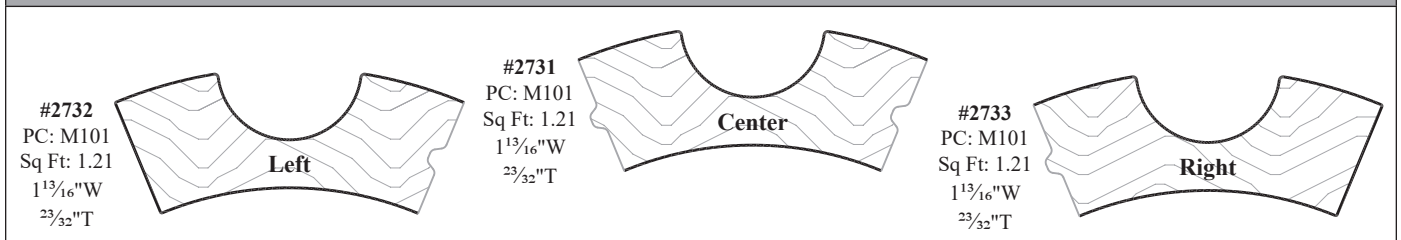

3" Radius - Fluted Face

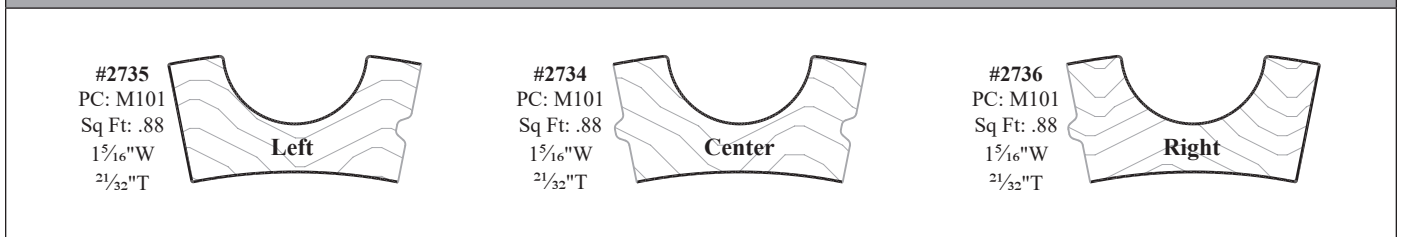

► For PRICING ► See Section N.7 in our current Wholesale Pricing Catalog.

Molding Options

Column Molding

5" Radius - Fluted Face

#2738
PC: M101
Sq Ft: 1.14
1²³/₃₂"W
1¹/₁₆"T

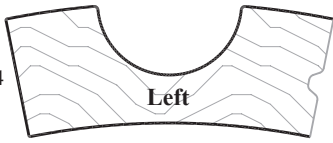

Left

#2737
PC: M101
Sq Ft: 1.14
1²³/₃₂"W
1¹/₁₆"T

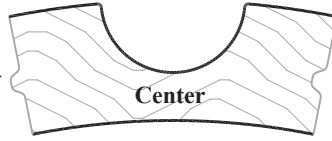

Center

#2739
PC: M101
Sq Ft: 1.14
1²³/₃₂"W
1¹/₁₆"T

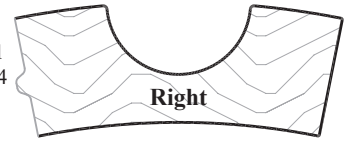

Right

5" Radius - Fluted Face



Left

#2559
PC: M101
Sq Ft: 1.40
2³/₃₂"W
1¹/₁₆"T

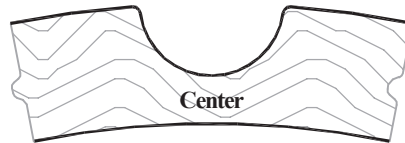

Center

#2558
PC: M101
Sq Ft: 1.40
2³/₃₂"W
1¹/₁₆"T

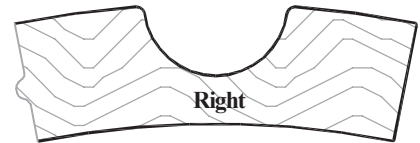

Right

#2560
PC: M101
Sq Ft: 1.40
2³/₃₂"W
1¹/₁₆"T

6" Radius - Fluted Face



Left

#2741
PC: M101
Sq Ft: 1.66
2¹/₂"W
2³/₃₂"T

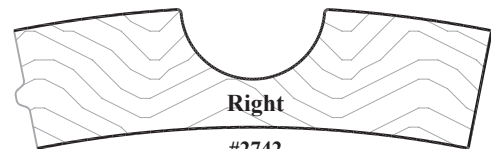

Right

#2742
PC: M101
Sq Ft: 1.66
2¹/₂"W
2³/₃₂"T

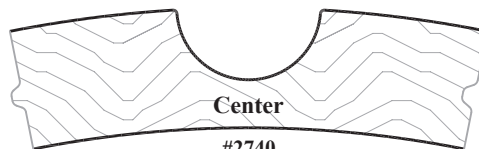

Center

#2740
PC: M101
Sq Ft: 1.66
2¹/₂"W
2³/₃₂"T

7" Radius - Fluted Face



Left

#2744
PC: M101
Sq Ft: 1.92
2⁷/₈"W
3⁴/₄"T



Right

#2745
PC: M101
Sq Ft: 1.92
2⁷/₈"W
3⁴/₄"T

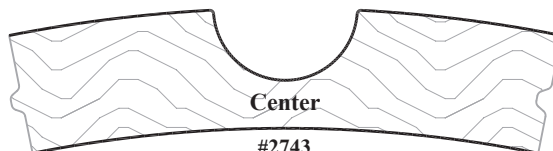

Center

#2743
PC: M101
Sq Ft: 1.92
2⁷/₈"W
3⁴/₄"T

► For PRICING ► See Section N.7 in our current Wholesale Pricing Catalog.

8" Radius - Fluted Face

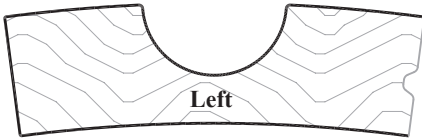

Left

#2747
PC: M101
Sq Ft: 1.46
2³/₁₆"W
1¹/₁₆"T

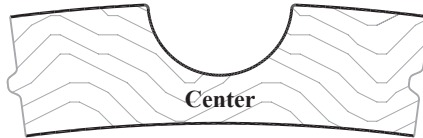

Center

#2746
PC: M101
Sq Ft: 1.46
2³/₁₆"W
1¹/₁₆"T

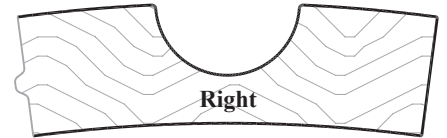

Right

#2748
PC: M101
Sq Ft: 1.46
2³/₁₆"W
1¹/₁₆"T

9" Radius - Fluted Face



Left

#2750
PC: M101
Sq Ft: 1.64
2⁷/₁₆"W
1¹/₁₆"T



Right

#2751
PC: M101
Sq Ft: 1.64
2¹⁵/₃₂"W
1¹/₁₆"T

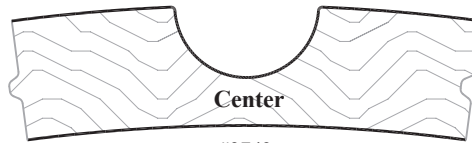

Center

#2749
PC: M101
Sq Ft: 1.64
2¹⁵/₃₂"W
1¹/₁₆"T

► For PRICING ► See Section N.7 in our current Wholesale Pricing Catalog.

Wainscot Cap/Backband Moldings

**** The addition of a Wainscot Cap Molding provides a finished look to wainscot panels. ****

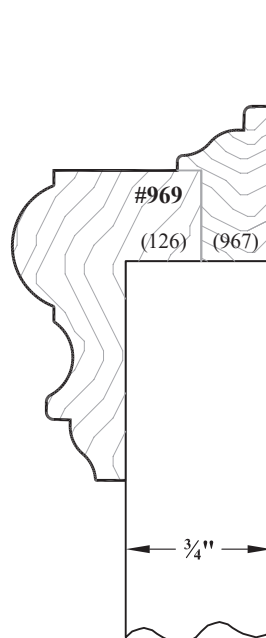
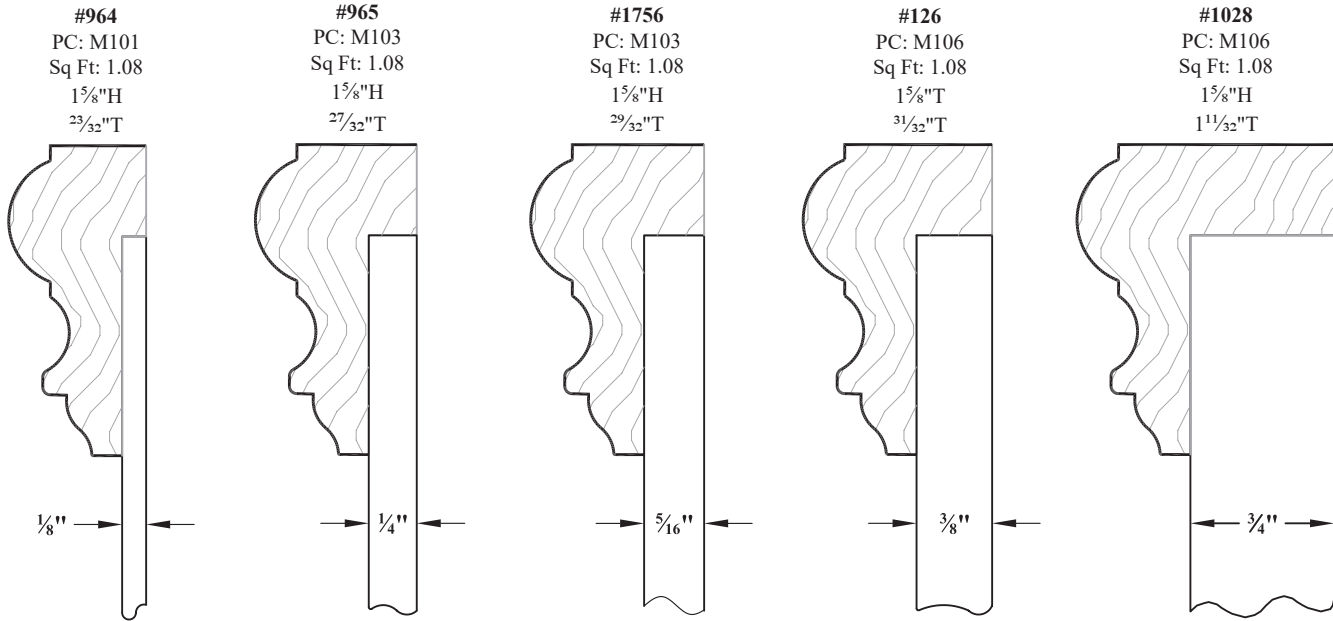

#969 Assembly
 PC: M103 + Assembly Fee
 Sq Ft: 1.61
 Two pieces, assembled
 by WalzCraft (126 + 967)

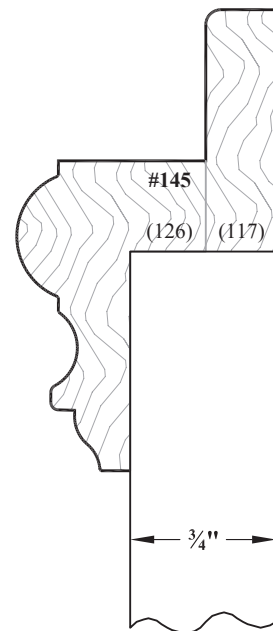

#145 Assembly
 PC: M103 + Assembly Fee
 Sq Ft: 1.92
 Two pieces, assembled
 by WalzCraft (126 + 117)

► **For PRICING** ► See Section N.8 in our current Wholesale Pricing Catalog.

Wainscot Cap / Backband Moldings

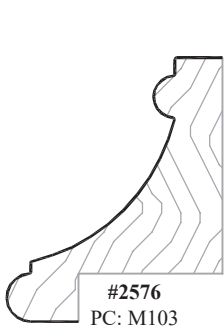

#2576
PC: M103
Sq Ft: .92
1 3/8"H
1 1/8"T

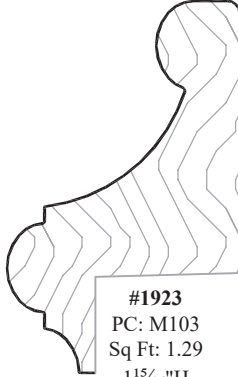

#1923
PC: M103
Sq Ft: 1.29
1 5/16"H
1 7/32"T

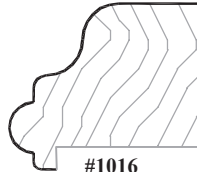

#1016
PC: M103
Sq Ft: .72
7/8"H
1"T

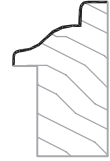

#967
PC: M103
Sq Ft: .72
1 3/16"H
1/2"T

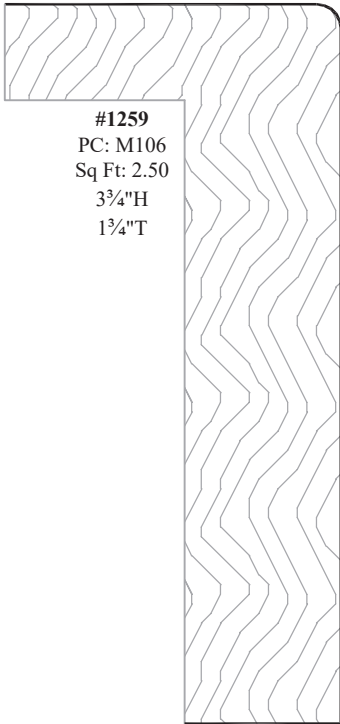

#1259
PC: M106
Sq Ft: 2.50
3 3/4"H
1 1/4"T

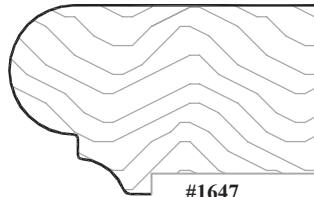

#1647
PC: M103
Sq Ft: 1.08
3 1/32"H
1 5/8"T

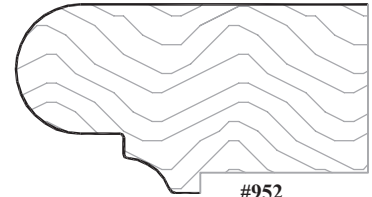

#952
PC: M103
Sq Ft: 1.22
3 1/32"H
1 27/32"T

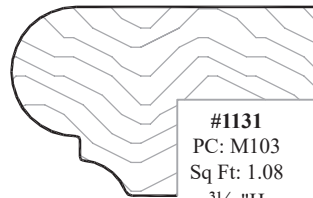

#1131
PC: M103
Sq Ft: 1.08
3 1/32"H
1 5/8"T

C = Available for Convex/Concave products. **★** = Available with 3D Laminate/RTF.

► **For PRICING** ► See Section N.8 in our current Wholesale Pricing Catalog.

N

Molding Options

Miscellaneous Molding

Color Block Molding

**** These 8' lengths of molding are designed to be cut to size and finished by our customers to use as color block samples. ****

#1288
PC: M102
Sq Ft: 3.31
4³¹/₃₂"W
1/4"T

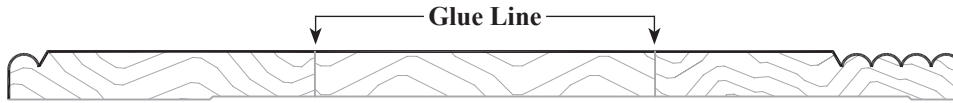

#1288: When cut in lengths of 5⁵/₈", these blocks will fit in CD racks for perfect storage and accessibility.

#2855
PC: M101
Sq Ft: 3.99
5³¹/₃₂"W
3/4"T



Door Jamb Stop Molding



#117
PC: M101
Sq Ft: .84
1 1/4"W
1 3/32"T

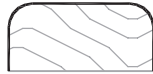

#1652
PC: M101
Sq Ft: .72
3/4"W
1 1/32"T



#972
PC: M101
Sq Ft: .84
1 1/4"W
1 3/32"T



#1619
PC: M102
Sq Ft: .84
1 1/4"W
1/4"T

Window Sill Moldings

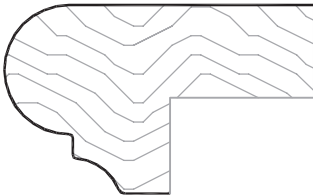

#1131
PC: M103
Sq Ft: 1.08
1 5/8"W
3 1/32"T

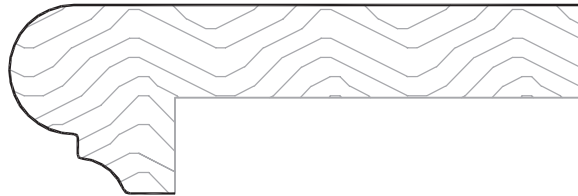

#1783
PC: M103
Sq Ft: 2.00
3"W
3 1/32"T

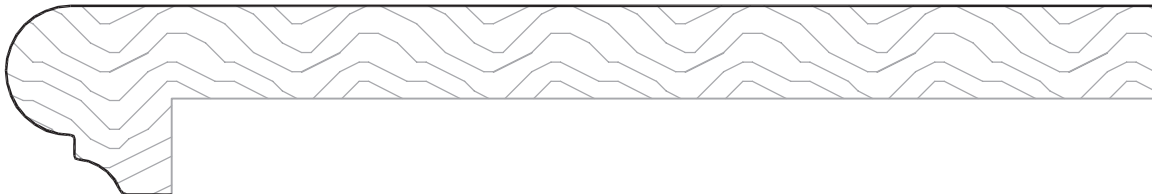

#1784
PC: M103
Sq Ft: 4.00
6"W
3 1/32"T

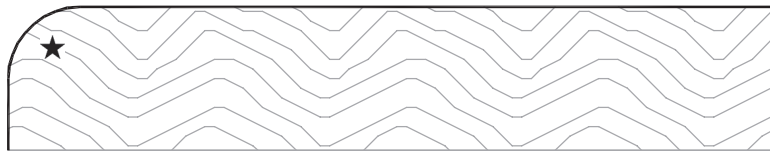

#122
PC: M101
Sq Ft: 2.67
4"W
3/4"T

► For PRICING ► See Section N.9 in our current Wholesale Pricing Catalog.

Miscellaneous Molding

Molding Options

Louvered Slat Molding (Non-Operable)

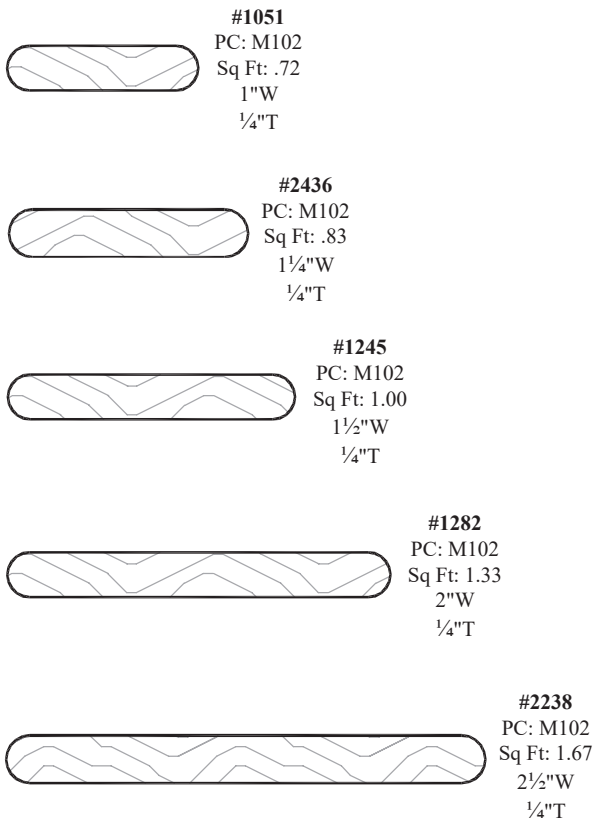

Louvered Slat Molding (Operable)

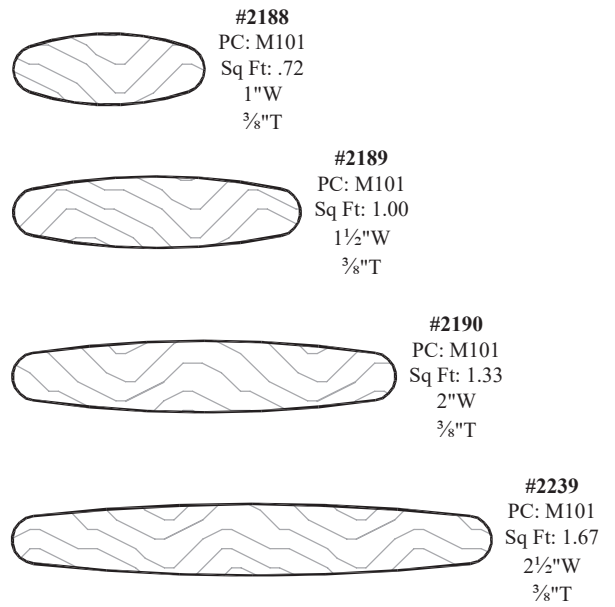

Operable Louver Actuator Molding

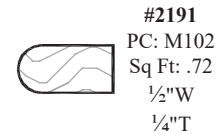

Inset Bead Molding

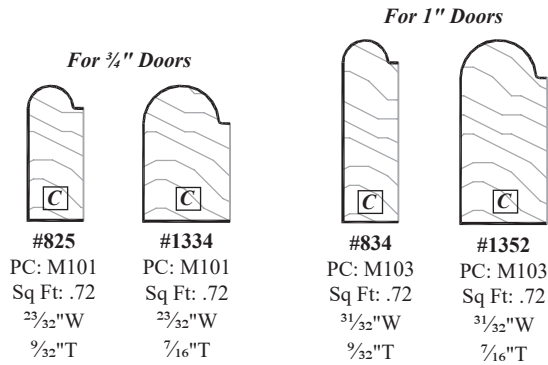

Designed to be pin-nailed to the inside edge of a face frame opening when using inset doors.

Square Peg Molding

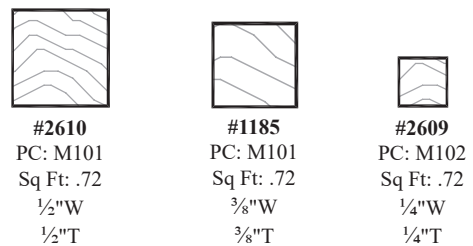

Lattice Spacer Molding

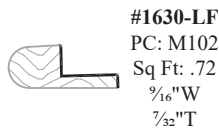

See Section N.3 for pricing "LF" moldings.

C = Available for Convex/Concave products. **R** = Available radiused to follow the contour of shaped rails.

► For PRICING ► See Section N.9 in our current Wholesale Pricing Catalog.

Molding Options

Miscellaneous Molding

Beaded Molding

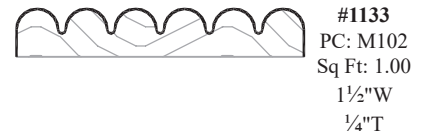
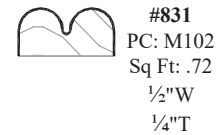
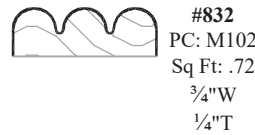
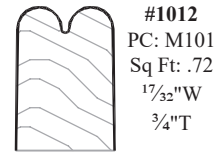
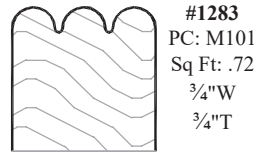
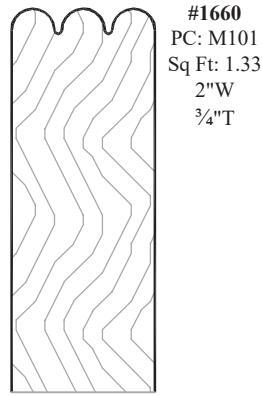
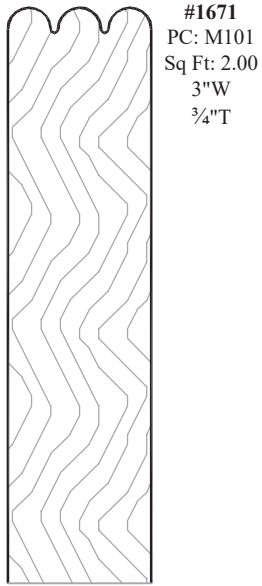

Miscellaneous Molding

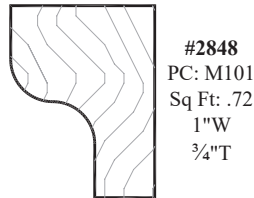
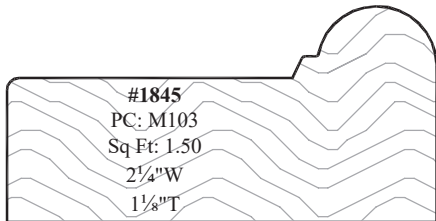
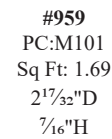
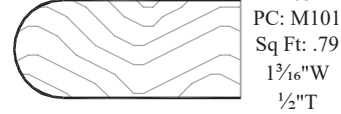
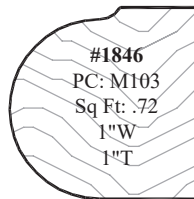
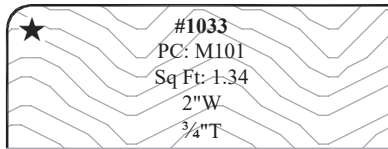
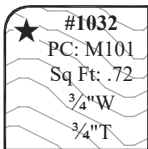
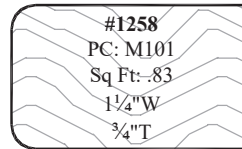
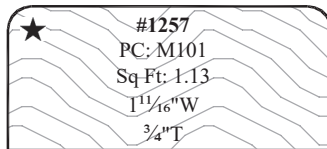
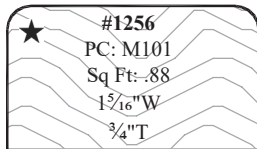
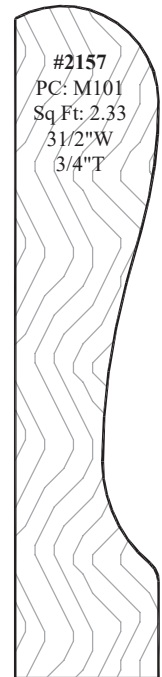
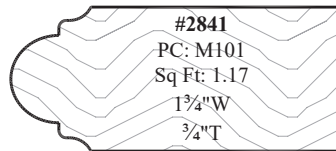
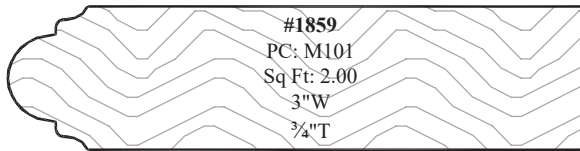

► For PRICING ► See Section N.9 in our current Wholesale Pricing Catalog.

Miscellaneous Molding

Molding Options

Finger Pull Molding (5/8" Thick Doors)

Typically the #2241, #2242 & #2243 moldings would be paired with a 5/8" thick melamine door or drawer front. See *Section F.8* for molding application drawings.

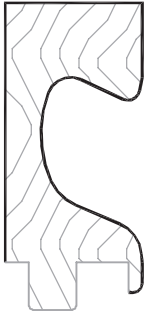

#2242
PC: M101
Sq Ft: 1.07
1 5/8"W
2 3/32"T

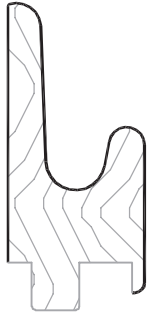

#2241
PC: M101
Sq Ft: 1.07
1 5/8"W
2 3/32"T

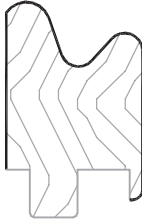

#2243
PC: M101
Sq Ft: .75
1 1/8"W
2 3/32"T



#2103
PC: M101
Sq Ft: 1.01
1 17/32"W
2 3/32"T



#2244
PC: M101
Sq Ft: 1.02
1 17/32"W
2 3/32"T



#2102
PC: M101
Sq Ft: .72
1 1/2"W
2 3/32"T

Finger Pull Molding (3/4" Thick Doors)

Typically the #1803, #1804 & #2211 moldings would be paired with a 3/4" thick veneered, MDF or RTF slab door or drawer front. See *Section F.8* for molding application drawings.



#1803
PC: M101
Sq Ft: 1.07
1 5/8"W
2 7/32"T

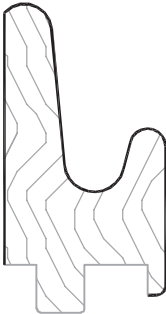

#1804
PC: M101
Sq Ft: 1.07
1 5/8"W
2 7/32"T

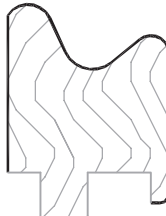

#2211
PC: M101
Sq Ft: .72
1 1/8"W
2 7/32"



#2209
PC: M101
Sq Ft: 1.02
1 17/32"W
2 7/32"T

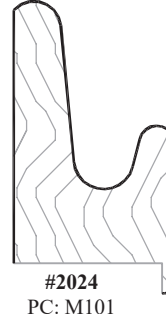

#2024
PC: M101
Sq Ft: 1.01
1 17/32"W
2 7/32"T

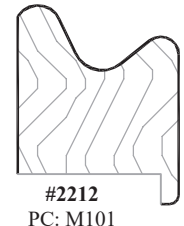

#2212
PC: M101
Sq Ft: .72
1 1/2"W
2 7/32"T

Drawer Glide Spacer Molding

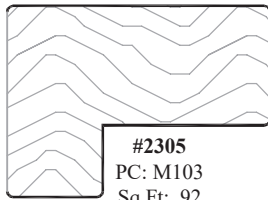

#2305
PC: M103
Sq Ft: .92
1 3/8"W
1"T

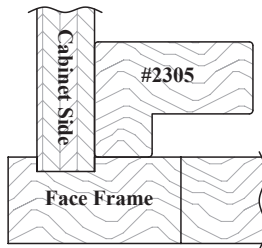

* Used to space drawer glide away from inside edge of face frame opening for hinge clearance.

Step Molding

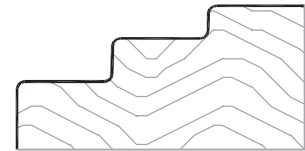

#1244
PC: M101
Sq Ft: 1.00
1 1/2"W
3/4"T

C = Available for Convex/Concave products. **R** = Available radiused to follow the contour of shaped rails. **★** = Available with 3D Laminate/RTF.

► For PRICING ► See Section N.9 in our current Wholesale Pricing Catalog.

Molding Options

Miscellaneous Molding

Wood Retainer Molding

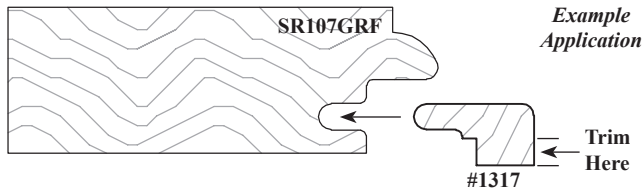

For 3/4" Doors

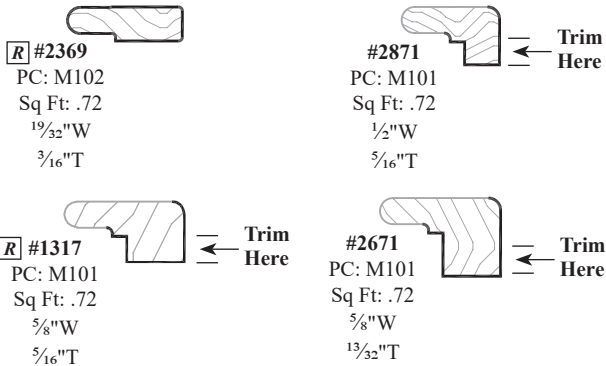

For 1" Doors

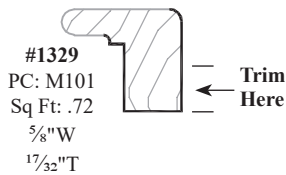

GRF Wood Filler Molding

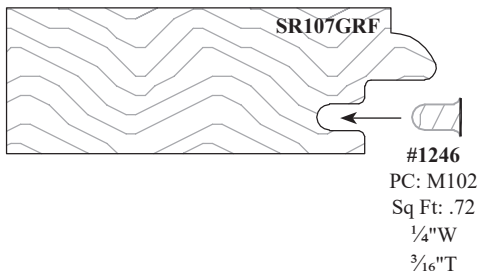

#1246
PC: M102
Sq Ft: .72
1/4"W
3/16"T

Wood Retainer Molding

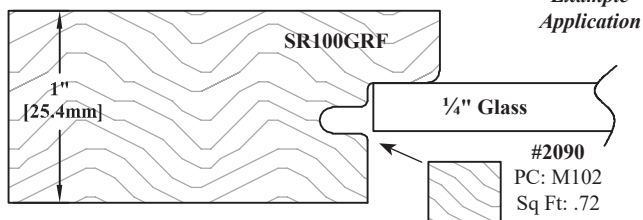

Note: SR100GRF shown at 1" thick.

#2090
PC: M102
Sq Ft: .72
3/8"W
5/16"H

Wood Retainer Molding

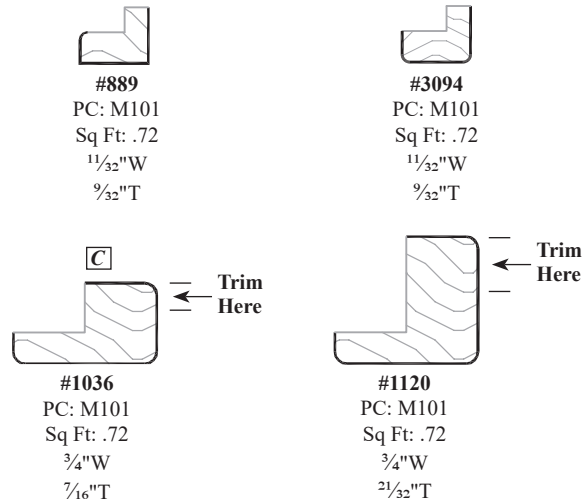
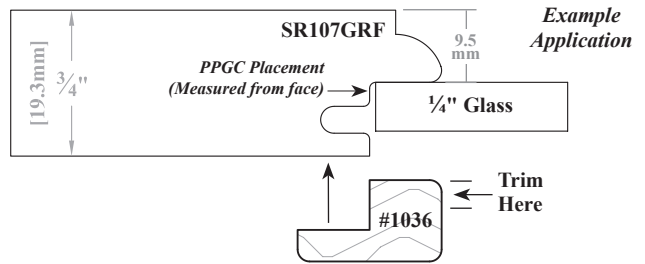

See Notes for more information.

Wood Tenon Filler Molding

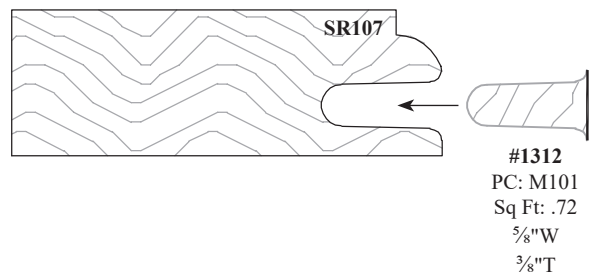

#1312
PC: M101
Sq Ft: .72
3/8"W
3/8"T

[C] = Available for Convex/Concave products. [R] = Available radiused to follow the contour of shaped rails.

► For PRICING ► See Section N.9 in our current Wholesale Pricing Catalog.

GRF Filler/Wood Retainer Molding

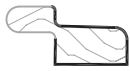

#997
PC: M101
Sq Ft: .72
5/8"W
3/16"T

Panel Location	S/R Thickness	Construction	Molding #	Price Class	Sq. Ft.
3.6mm	3/4"	Traditional	#2919	M101	0.72
3.6mm	1"	Traditional	#2918	M101	0.72
6.9mm	3/4"	Traditional	#2914	M101	0.72
6.9mm	1"	Traditional	#2915	M101	0.72
9.5mm	3/4"	Traditional	#997	M101	0.72
9.5mm	1"	Traditional	#998	M101	0.72
13.5mm	1"	Old World	#2916	M101	0.72
13.5mm	1 1/4"	Old World	#2917	M101	0.72

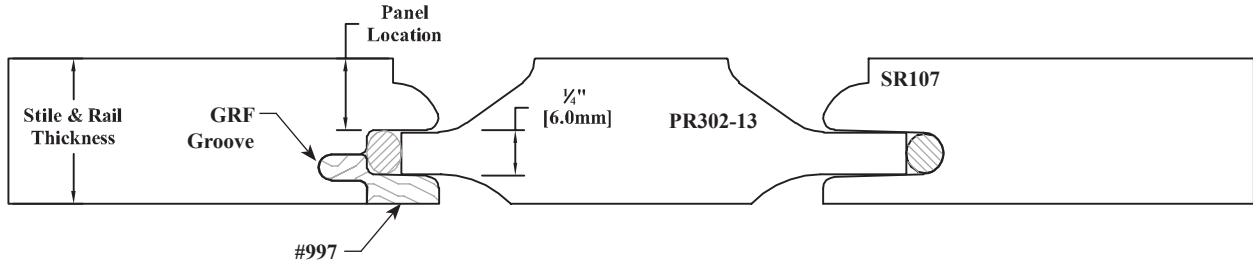

Molding #2933, #3041, #3042 - Wood Retainer Molding for True Lite Retainer Groove (TLRG)

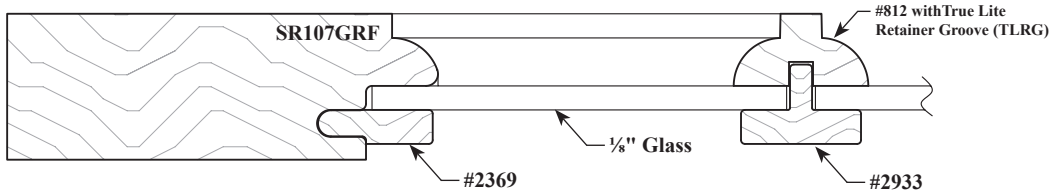

#3042
PC: M101
Sq Ft: .72
7/16"W
13/32"T

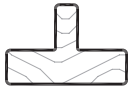

#2933
PC: M101
Sq Ft: .72
5/8"W
13/32"T



#3041
PC: M101
Sq Ft: .72
1 1/32"W
13/32"T

Mullion Molding Width	Wood Retainer Molding
1 5/32" [12.0mm] to 3 9/64" [15.8mm]	Molding #3042
5/8" [15.9mm] to 1 3/64" [26.9mm]	Molding #2933
1 1/16" [27.0mm] to 1 31/64" [38.0mm]	Molding #3041

Ordering & Pricing Notes: Wood Retainer/Filler Molding

Ordering Guidelines

1	Order Forms	Please use <i>Molding & Miscellaneous Order Form (E-Z Form #5)</i> .
---	-------------	--

Pricing

1	Pricing	Please see <i>Section N.9</i> of our current Wholesale Pricing Catalog.
---	---------	---

Technical Notes: Wood Retainer/Filler Molding

Cabinet Door & Drawer Front Options (Chapter B)

1	Cut to Size	See <i>Section B.12</i> for Cut to Size options and price classes.
---	-------------	--

Continued on next page...

► For PRICING ► See Section N.9 in our current Wholesale Pricing Catalog.

Molding Options

Miscellaneous Molding

Technical Notes: Wood Retainer/Filler Molding...continued

Molding Options (Chapter N)

1	#997 GRF Filler/Wood Retainer Molding	Designed to fill WalzCraft's GRF groove prior to assembly and provide a space for ¼" thick material.
2	#889, #1036, #1120, #3094 Wood Retainer Molding	Designed for use as a wood retainer molding that is fastened to the rear of the frame and can be trimmed to size. See Wood Retainer Molding Compatibility chart on our website: Resources/Technical Information for which molding to be used based on glass thickness (½" or ¼"), door thickness and panel plow groove cut placement (PPGC). • Note: #889 not available as a precision cut molding.
3	#1246 GRF Wood Filler Molding	The illustration shows an example of how this molding fits into the GRF groove of the stile and rail profile. Designed to fill the void for the GRF groove in the stiles and rails of frame and mullion doors. For use with ¾" [19.1mm] or 1" [25.4mm] thick doors.
4	#1312 Wood Tenon Filler Molding	The illustration shows an example of how this molding fits into the mortise of the stile and rail profile. Designed to fill the mortise PPGC (Panel Plow Groove Cut) of any stile and rail profile, for your custom frame requirements. For use with ¾" [19.1mm] or 1" [25.4mm] thick doors.
5	#1317, #1329, #2369, #2871 Wood Retainer Molding	Fit into the GRF cut of the stile and rail profile and are designed to be used with ⅝" [3.2mm] materials.
6	#2090 Wood Retainer Molding	Designed for use as a wood retainer molding to accommodate ¼" [6.4mm] material for use with 1" [25.4mm] thick frames.
7	#2933, #3041, #3042 Wood Retainer Molding for True Lite Retainer Groove	Designed to be used as a wood retainer molding for true divided mullion lites. Only available with the following mullion lite patterns: LP001, LP108, LP109, LP110, LP118, LP128, LP131, LP146, LP147. Please submit requests for this application to our Customer Support Team.
8	#2671 Wood Retainer Molding	Fit into the GRF cut of the stile and rail profile and are designed to be used with ⅝" [3.2mm] materials. Designed for use with: • Traditional stile & rail GRF profiles: SR123, SR145, SR146, SR157, SR160, SR163, SR167, SR169. • Mitered stile & rail GRF profile families: MP628, MP661, MP662, MP680, MP690, MP696, MP6104. • All traditional and mitered Old World stile & rail GRF profiles from Section E.3 and E.11 .

GRF Extension Molding (Used with some applied moldings)



#963
PC: M101
Sq Ft: .72
27/32"W
3/8"T

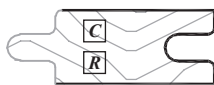

#888
PC: M101
Sq Ft: .72
1 3/32"W
3/8"T



#962
PC: M101
Sq Ft: .80
1 7/32"
3/8"



#1716
PC: M101
Sq Ft: 1.06
1 1/32"W
3/8"T

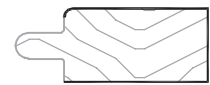

#2365
PC: M101
Sq Ft: 1.06
1"W
3/8"T

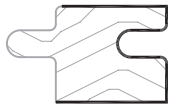

#2923
PC: M101
Sq Ft: .72
27/32"W
1/2"W

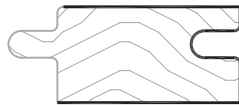

#2924
PC: M101
Sq Ft: .81
1 7/32"W
1/2"T

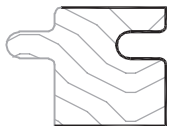

#1137
PC: M101
Sq Ft: .72
27/32"W
5/8"T

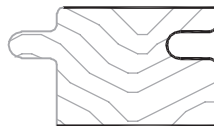

#1135
PC: M101
Sq Ft: .72
1 3/32"W
5/8"T

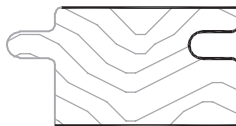

#1136
PC: M101
Sq Ft: .80
1 7/32"W
5/8"T

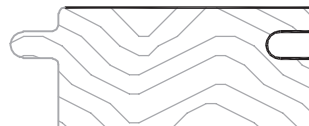

#1719
PC: M101
Sq Ft: 1.06
1 1/32"W
5/8"T

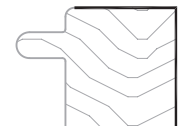

#2812
PC: M101
Sq Ft: .72
27/32"W
5/8"T

C = Available for Convex/Concave products. **R** = Available radiused to follow the contour of shaped rails. **★** = Available with 3D Laminate/RTF.

► For PRICING ► See Section N.9 in our current Wholesale Pricing Catalog.



Miscellaneous Molding

Molding Options

Shelf Bull Nose Molding

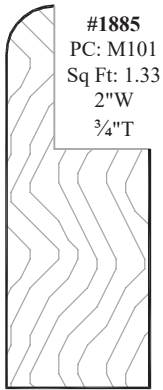

#1885
PC: M101
Sq Ft: 1.33
2"W
3/4"T

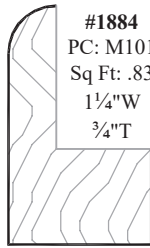

#1884
PC: M101
Sq Ft: .83
1 1/4"W
3/4"T

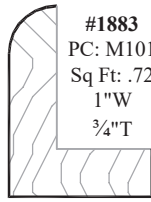

#1883
PC: M101
Sq Ft: .72
1"W
3/4"T

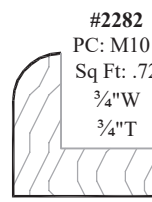

#2282
PC: M101
Sq Ft: .72
3/4"W
3/4"T



#1882
PC: M102
Sq Ft: .72
3/4"W
1/4"T



#2281
PC: M102
Sq Ft: .72
1/2"W
1/4"T

Edgeband Molding

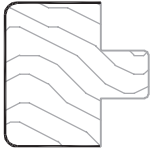

#1324
PC: M101
Sq Ft: .72
3/4"W
3/4"T

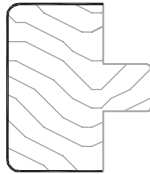

#2382
PC: M101
Sq Ft: .72
7/8"W
3/4"T

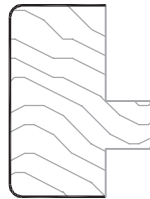

#1326
PC: M101
Sq Ft: .72
7/8"W
3/4"T

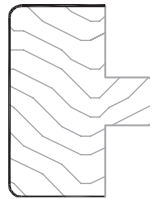

#2383
PC: M101
Sq Ft: .72
1"W
3/4"T



#3173
PC: M102
Sq Ft: .72
7/8"W
1/8"T



#1785
PC: M101
Sq Ft: .72
27/32"W
5/32"T



#1786
PC: M101
Sq Ft: .72
27/32"W
1/4"T



#3153
PC: M103
Sq Ft: .72
1 3/32"W
5/32"T



3154
PC: M103
Sq Ft: .72
1 3/32"W
1/4"T

Countertop Edge Molding

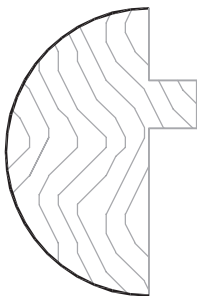

#1297
PC: M103
Sq Ft: 1.00
1 1/2"W
1"T

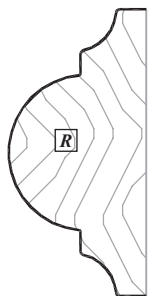

#1917
PC: M101
Sq Ft: 1.00
1 1/2"W
23/32"T

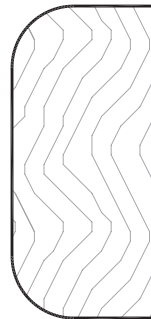

#2856
PC: M101
Sq Ft: 1.08
1 5/8"W
3/4"T

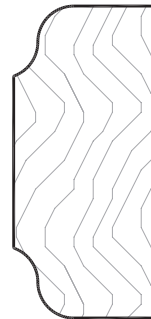

#2857
PC: M101
Sq Ft: 1.08
1 5/8"W
3/4"T



#2858
PC: M101
Sq Ft: 1.08
1 5/8"W
3/4"T

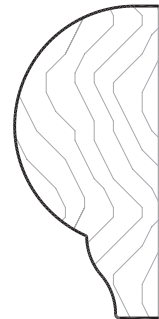

#2859
PC: M101
Sq Ft: 1.08
1 5/8"W
3/4"T

C = Available for Convex/Concave products. **R** = Available radiused to follow the contour of shaped rails. **★** = Available with 3D Laminate/RTF.

► For PRICING ► See Section N.9 in our current Wholesale Pricing Catalog.

Molding Options

Miscellaneous Molding

Under Cabinet (Light Rail) & Over Cabinet Moldings

#1069
PC: M101
Sq Ft: 1.50
2¼"W
¾"T

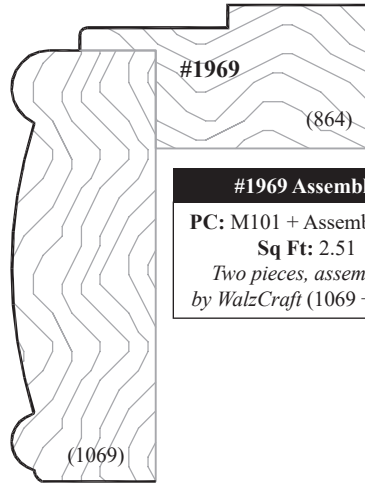

#1969 Assembly
PC: M101 + Assembly Fee
Sq Ft: 2.51
Two pieces, assembled
by WalzCraft (1069 + 864).

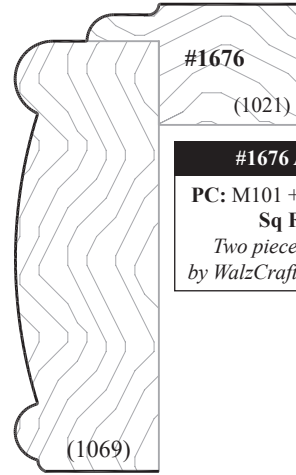

#1676 Assembly
PC: M101 + Assembly Fee
Sq Ft: 2.25
Two pieces, assembled
by WalzCraft (1069 + 1021).

#1650
PC: M101
Sq Ft: 1.00
1½"W
¾"T

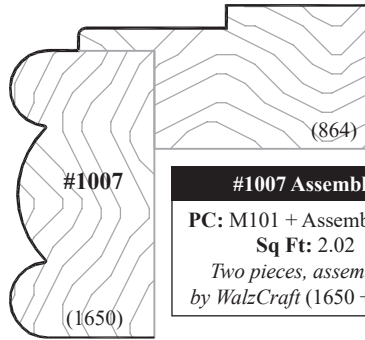

#1007 Assembly
PC: M101 + Assembly Fee
Sq Ft: 2.02
Two pieces, assembled
by WalzCraft (1650 + 864).

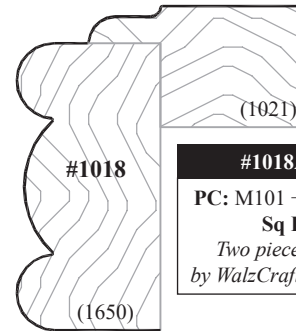

#1018 Assembly
PC: M101 + Assembly Fee
Sq Ft: 1.75
Two pieces, assembled
by WalzCraft (1650 + 1021).

#2726
PC: M101
Sq Ft: 1.00
1½"W
¾"T

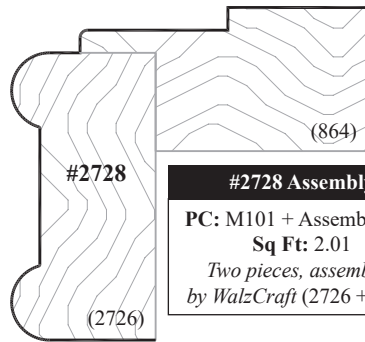
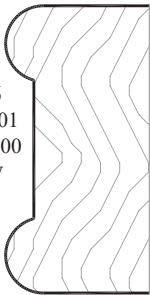

#2728 Assembly
PC: M101 + Assembly Fee
Sq Ft: 2.01
Two pieces, assembled
by WalzCraft (2726 + 864).

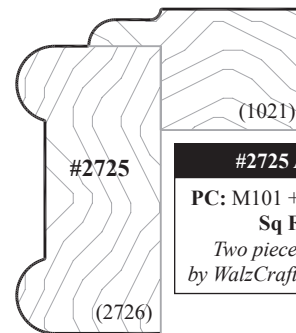

#2725 Assembly
PC: M101 + Assembly Fee
Sq Ft: 1.75
Two pieces, assembled
by WalzCraft (2726 + 1021).

Continued on next page...

☐ = Available for Convex/Concave products. ☐^R = Available radiused to follow the contour of shaped rails. ★ = Available with 3D Laminate/RTF.

► For PRICING ► See Section N.9 in our current Wholesale Pricing Catalog.



Under Cabinet (Light Rail) & Over Cabinet Moldings...continued

#2730
PC: M101
Sq Ft: 1.50
2 1/4"W
3/4"T



#2729

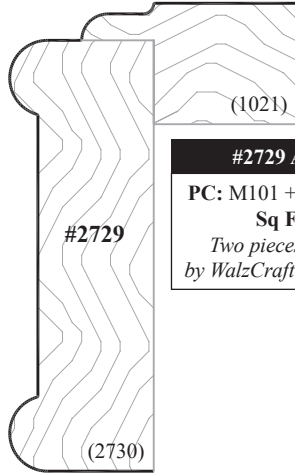

(1021)

#2729 Assembly

PC: M101 + Assembly Fee
Sq Ft: 2.25
Two pieces, assembled
by WalzCraft (2730 + 1021).

#3155

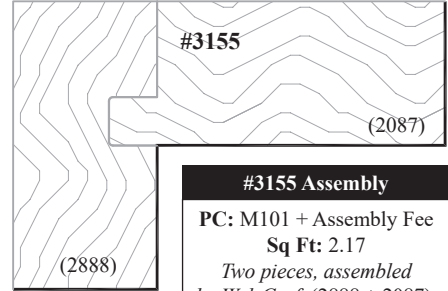

(2087)

#3155 Assembly

PC: M101 + Assembly Fee
Sq Ft: 2.17
Two pieces, assembled
by WalzCraft (2888 + 2087).

#2601
PC: M101
Sq Ft: 1.17
1 3/4"W
3/4"



Accepts
3/4" Inserts
(See Website)

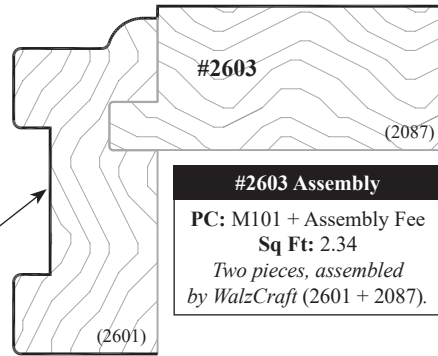

#2603

(2087)

#2603 Assembly

PC: M101 + Assembly Fee
Sq Ft: 2.34
Two pieces, assembled
by WalzCraft (2601 + 2087).

#2602
PC: M101
Sq Ft: 1.17
1 3/4"W
3/4"T

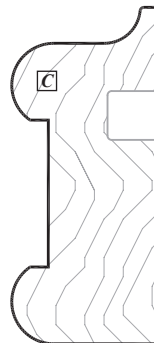

Accepts
3/4" Inserts
(See Website)

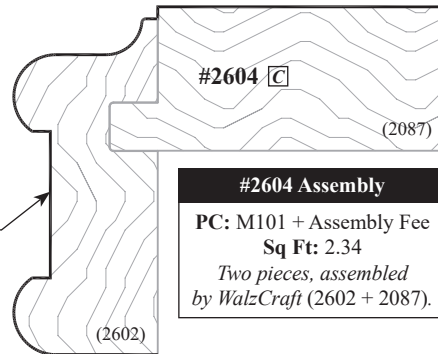

#2604 C

(2087)

#2604 Assembly

PC: M101 + Assembly Fee
Sq Ft: 2.34
Two pieces, assembled
by WalzCraft (2602 + 2087).

Continued on next page...

C = Available for Convex/Concave products. R = Available radiused to follow the contour of shaped rails. ★ = Available with 3D Laminate/RTF.

► For PRICING ► See Section N.9 in our current Wholesale Pricing Catalog.

Under Cabinet (Light Rail) & Over Cabinet Moldings...continued

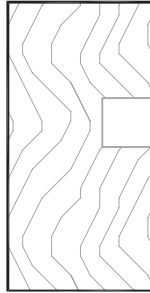

#2888
PC: M101
Sq Ft: 1.00
1½"W
¾"T

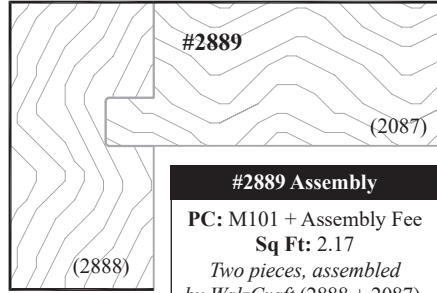

#2889
(2087)

#2889 Assembly
PC: M101 + Assembly Fee
Sq Ft: 2.17
*Two pieces, assembled
by WalzCraft (2888 + 2087).*

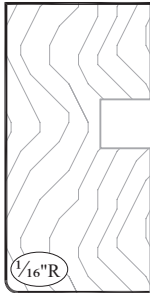

#3045
PC: M101
Sq Ft: 1.00
1½"W
¾"T

1/16"R

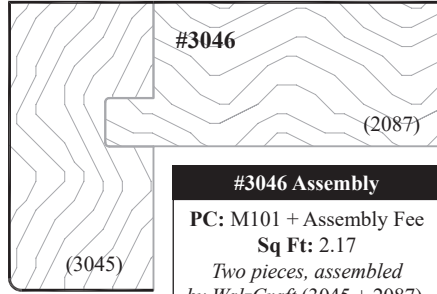

#3046
(2087)

#3046 Assembly
PC: M101 + Assembly Fee
Sq Ft: 2.17
*Two pieces, assembled
by WalzCraft (3045 + 2087).*



#2086
PC: M101
Sq Ft: 1.00
1½"W
¾"T

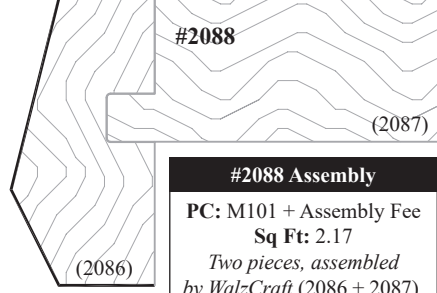

#2088
(2087)

#2088 Assembly
PC: M101 + Assembly Fee
Sq Ft: 2.17
*Two pieces, assembled
by WalzCraft (2086 + 2087).*

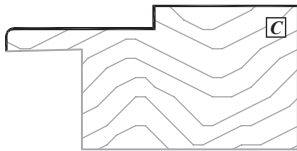

#864
PC: M101
Sq Ft: 1.01
1½"W
¾"T

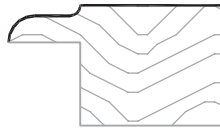

#1021
PC: M101
Sq Ft: .75
1½"W
5/8"T

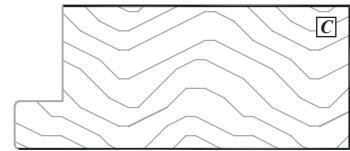

#2087
PC: M101
Sq Ft: 1.17
1¾"W
¾"T

Continued on next page...

► **For PRICING** ► See Section N.9 in our current Wholesale Pricing Catalog.

Under Cabinet (Light Rail) & Over Cabinet Moldings...continued

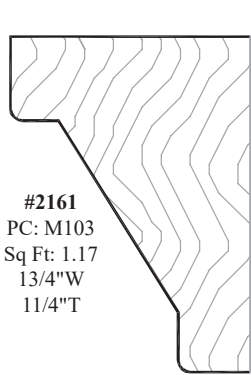

#2161
PC: M103
Sq Ft: 1.17
13/4"W
11/4"T

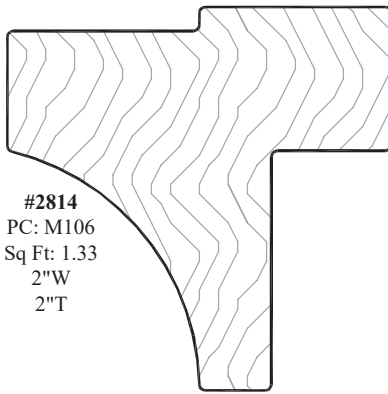

#2814
PC: M106
Sq Ft: 1.33
2"W
2"T



#1285
PC: M101
Sq Ft: 1.17
1 3/4"W
1 1/16"T

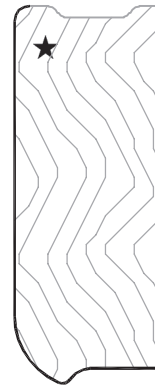

#118
PC: M101
Sq Ft: 1.31
1 3/32"W
3/4"T

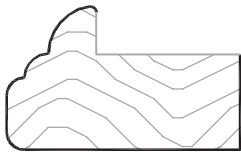

#2078
PC: M101
Sq Ft: .81
1 7/32"W
3/4"T

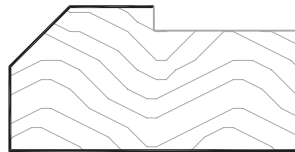

#2687
PC: M101
Sq Ft: 1.00
1 1/2"W
3/4"T

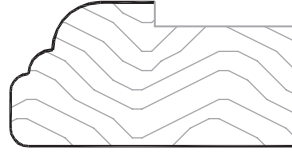

#2688
PC: M101
Sq Ft: 1.00
1 1/2"W
3/4"T

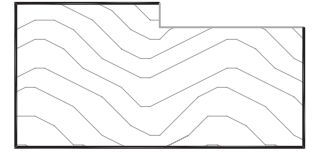

#2689
PC: M101
Sq Ft: 1.00
1 1/2"W
23/32"T

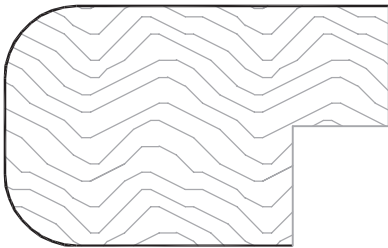

#2480
PC: M103
Sq Ft: 1.33
2"W
1 1/4"T

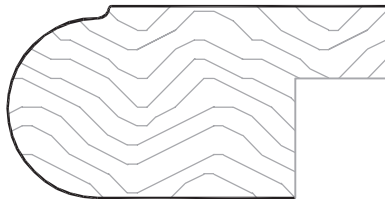

#1997
PC: M103
Sq Ft: 1.33
2"W
1"T

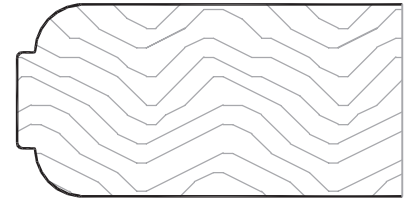

#1798
PC: M103
Sq Ft: 1.34
2"W
1"T



#1720
PC: M101
Sq Ft: 1.42
2 1/8"W
3/4"T



#1894
PC: M101
Sq Ft: 1.33
2"W
25/32"T

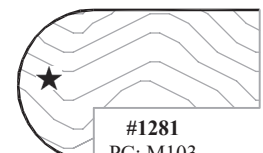

#1281
PC: M103
Sq Ft: .84
1 1/4"W
25/32"T

Continued on next page...

C = Available for Convex/Concave products. **R** = Available radiused to follow the contour of shaped rails. **★** = Available with 3D Laminate/RTF.

► For PRICING ► See Section N.9 in our current Wholesale Pricing Catalog.

Under Cabinet (Light Rail) & Over Cabinet Moldings...continued

#1871
PC: M101
Sq Ft: .83
1¼"W
1¼"T

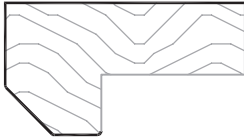

#1773
PC: M101
Sq Ft: .72
1"W
27/32"T



Wire track for
under cabinet
lighting.

#2317
PC: M103
Sq Ft: .83
1¼"W
1"T

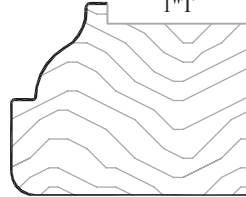

#2316
PC: M101
Sq Ft: .75
1⅛"W
23/32"T

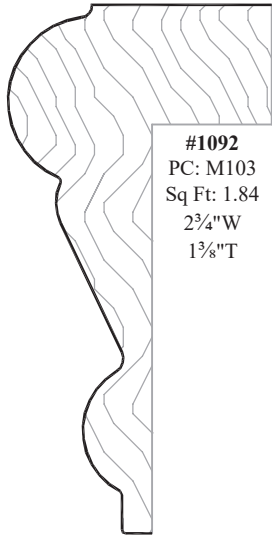
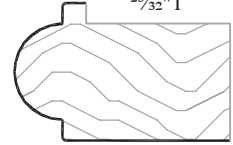

#1092
PC: M103
Sq Ft: 1.84
2¾"W
1⅜"T

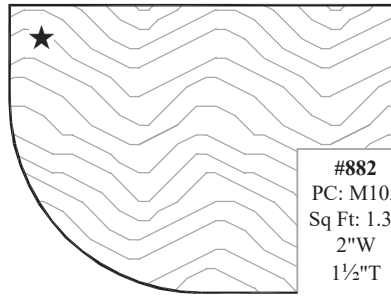

#882
PC: M105
Sq Ft: 1.33
2"W
1½"T

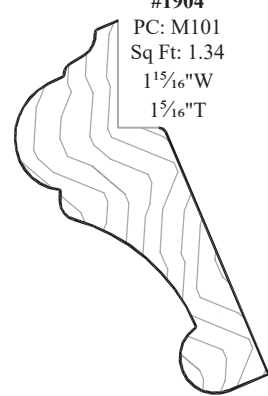

#1904
PC: M101
Sq Ft: 1.34
1⅝"W
1⅝"T

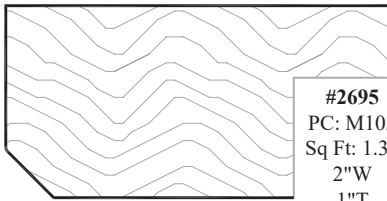

#2695
PC: M103
Sq Ft: 1.33
2"W
1"T

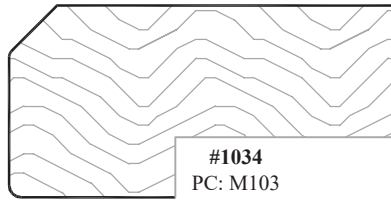

#1034
PC: M103
Sq Ft: 1.33
2"W
1"T

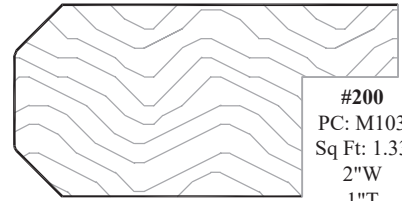

#200
PC: M103
Sq Ft: 1.33
2"W
1"T

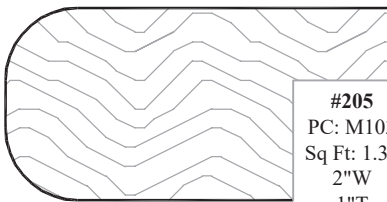

#205
PC: M103
Sq Ft: 1.33
2"W
1"T

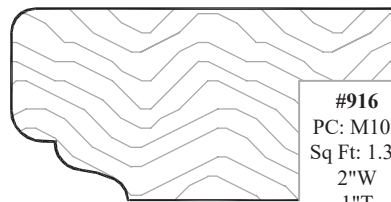

#916
PC: M103
Sq Ft: 1.33
2"W
1"T

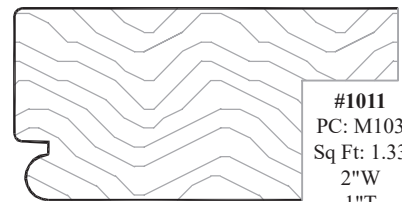

#1011
PC: M103
Sq Ft: 1.33
2"W
1"T

Under Cabinet (Light Rail) & Over Cabinet Moldings - END

► **For PRICING** ► See Section N.9 in our current Wholesale Pricing Catalog.

Spice Rack Molding

- The #919 and #920 moldings can be used to construct spice racks, church pew book holders, or other small shelving units.
- The example at left shows the #919 molding.
- 3/16" Refacing Stock works well for making the bottoms and fronts.
- See Section N.2 for 3/16" Solid Wood Refacing Stock.

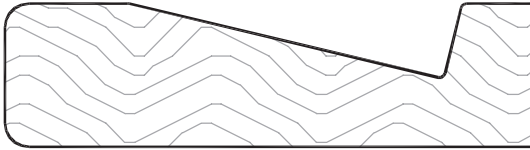

#919
PC: M101
Sq Ft: 1.83
2 3/4"W
3/4"T

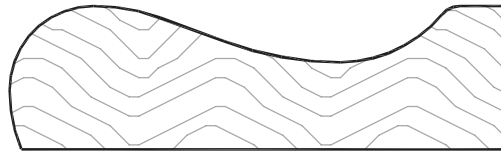

#920
PC: M101
Sq Ft: 1.73
2 1/2"W
3/4"T

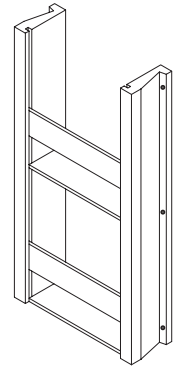

Tiered Spice Drawer Molding

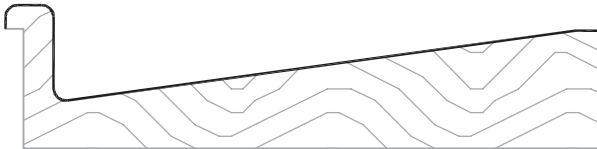

#2276
PC: M101
Sq Ft: 2.06
3 3/2"W
3/4"T

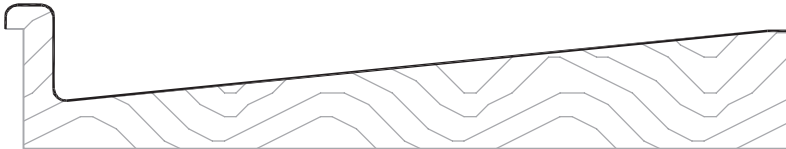

#2277
PC: M101
Sq Ft: 2.73
4 3/2"W
3/4"T

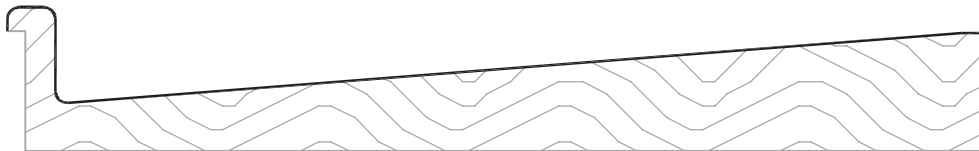

#2278
PC: M101
Sq Ft: 3.40
5 3/2"W
3/4"T

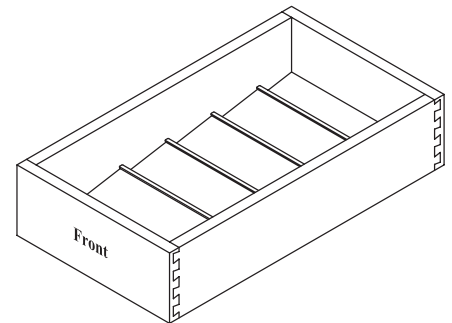

Drawer Box Divider Molding

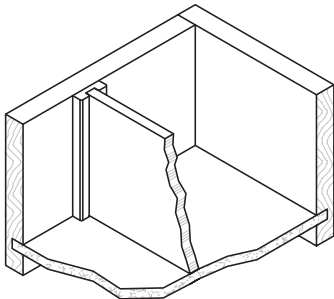

- Available in 8' lengths.
- Designed to be attached to the inside of drawer boxes to accept 3/16", 1/4", 3/8" or 1/2" thick divider material.



#1686
PC: M102
Sq Ft: .72
1 1/16"W
1/4"T



#845
PC: M102
Sq Ft: .72
3/4"W
1/4"T



#1687
PC: M102
Sq Ft: .72
7/8"W
1/4"T



#1688
PC: M102
Sq Ft: .72
1"W
1/4"T

Pencil Tray Molding

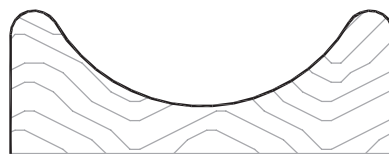

#1898
PC: M101
Sq Ft: 1.33
2"W
3/4"T

► For PRICING ► See Section N.9 in our current Wholesale Pricing Catalog.

Molding Options

Miscellaneous Molding

Fireplace Surround Molding

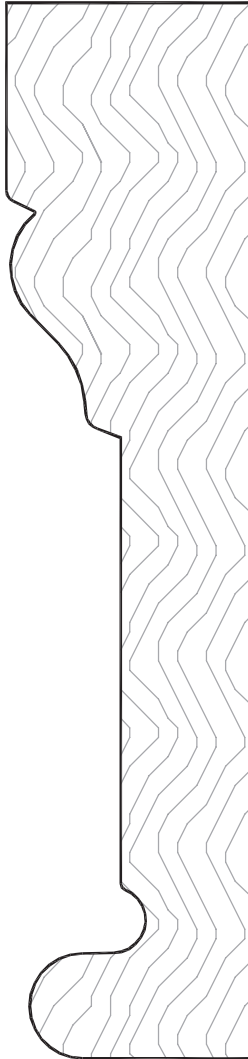

#1377
 PC: M103
 Sq Ft: 3.67
 5½"W
 1⅜"T

Frieze Molding



Accepts
 2¼" Inserts
 (See Website)

#2598
 PC: M101
 Sq Ft: 2.33
 3½"W
 ¾"T

Wine Rack Molding



#893
 PC: M104
 Sq Ft: .72
 ¾"W
 1⅜"T

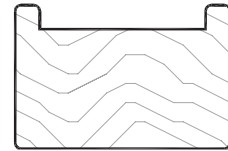

#2279
 PC: M101
 Sq Ft: .75
 1⅞"W
 ¾"T

Plate Display Molding

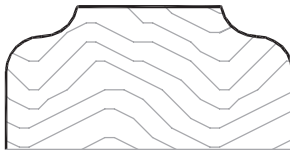

#980
 PC: M101
 Sq Ft: 1.00
 1½"W
 ¾"T

N

Half Lap Molding

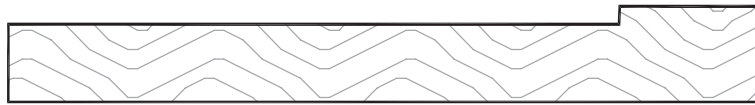

#1658
PC: M101
Sq Ft: 2.62
3 1/16"W
1/2"T

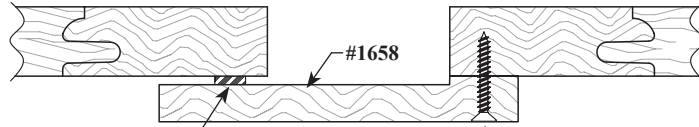

Door bumper by other.

Wood screw by other.

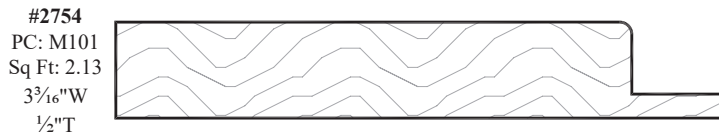

#2754
PC: M101
Sq Ft: 2.13
3 3/16"W
1/2"T



Wood screw supplied by customer.



#2884
PC: M101
Sq Ft: .72
3/4"W
3/8"T

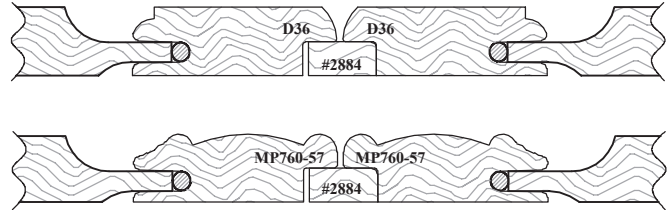

Half lap molding #2754 & #2884 designed for outside edge profiles with 3/8" x 3/8" dado on back.

Astragal Molding



#992
PC: M101
Sq Ft: .84
1 1/4"W
3/8"T



#996
PC: M101
Sq Ft: .84
1 1/4"W
3/8"T



#993
PC: M101
Sq Ft: .84
1 1/4"W
3/8"T

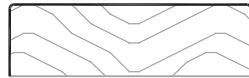

#994
PC: M101
Sq Ft: .84
1 1/4"W
3/8"T

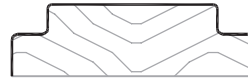

#995
PC: M101
Sq Ft: .84
1 1/4"W
3/8"T

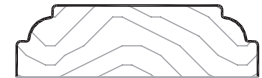

#2147
PC: M101
Sq Ft: .84
1 1/4"W
3/8"T

Molding Options

Miscellaneous Molding

Dentil and Accent Molding for Adding to Crown Molding

Dentil Molding

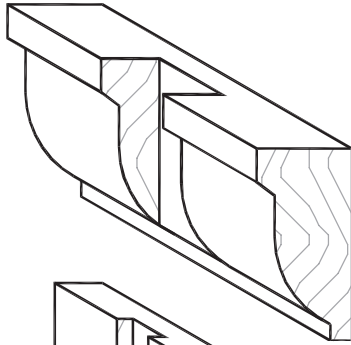

#1238
 PC: M101
 + Dentil Pattern Fee
 Sq Ft: .72
 7/16"D
 1"H

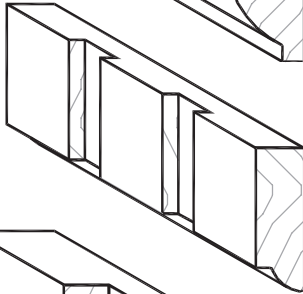

#829
 PC: M101
 + Dentil Pattern Fee
 Sq Ft: .72
 1/4"D
 3/4"H

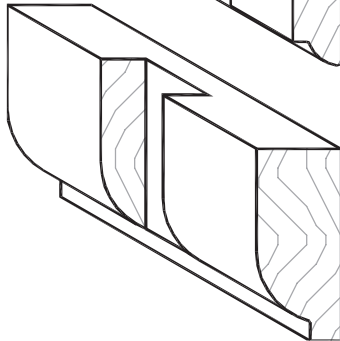

#1239
 PC: M101
 + Dentil Pattern Fee
 Sq Ft: .72
 1/4"D
 3/4"H

Accent Molding

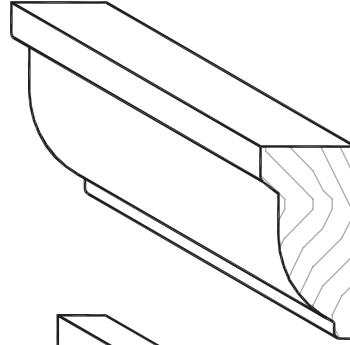

#1741
 PC: M101
 Sq Ft: .72
 1/2"D
 1"H

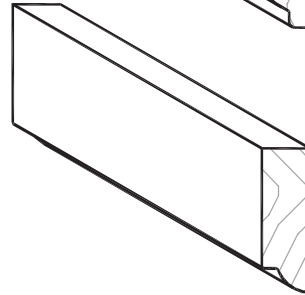

#1928
 PC: M102
 Sq Ft: .72
 1/4"D
 3/4"H

Dentil and Accent Moldings

Molding #1238, 1239, 1741 and 1928 can be used by themselves or applied as an accent to crown molding. See *Section N.1* for crown molding options.

Chair Rail Molding

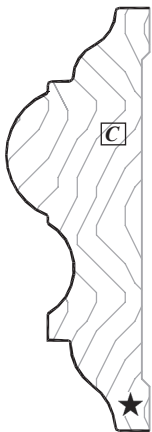

#125
 PC: M101
 Sq Ft: 1.47
 2 7/32"W
 3/4"T

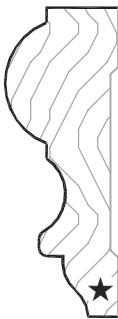

#156
 PC: M101
 Sq Ft: 1.08
 1 5/8"W
 1 9/32"T



#2794
 PC: M101
 Sq Ft: 1.08
 1 5/8"W
 5/8"T

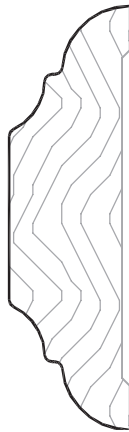

#828
 PC: M101
 Sq Ft: 1.47
 2 7/32"W
 5/8"T

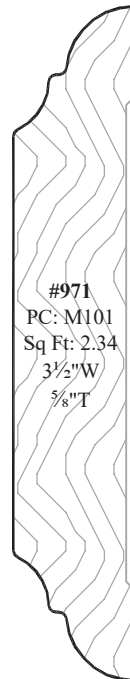

#971
 PC: M101
 Sq Ft: 2.34
 3 1/2"W
 5/8"T

Retail Price Tag Molding

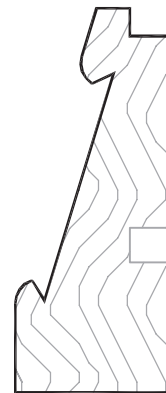

#2173
 PC: M101
 Sq Ft: 1.33
 2"W
 1 3/16"T

Miscellaneous Molding

Molding Options

Dowel Molding

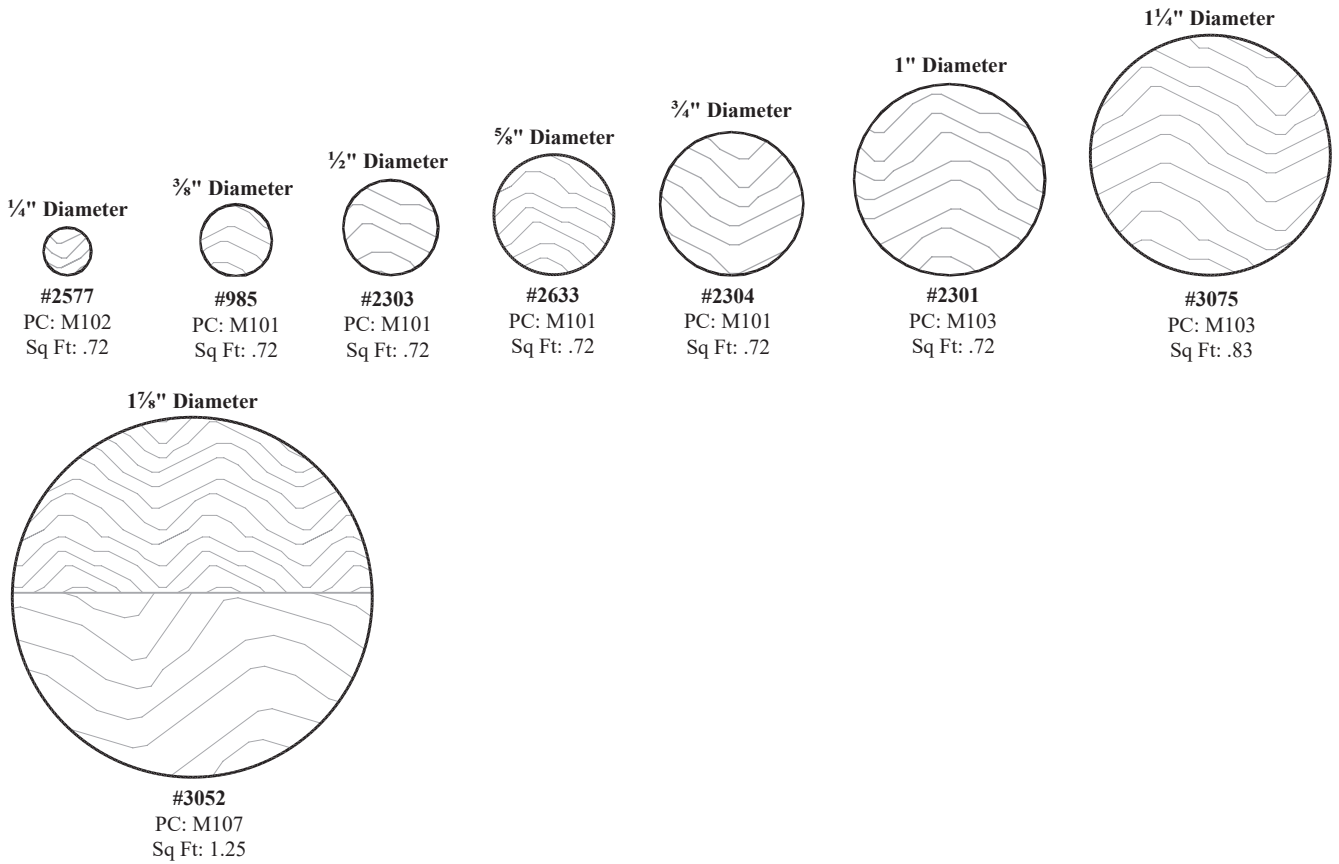

N

Pyramid Molding

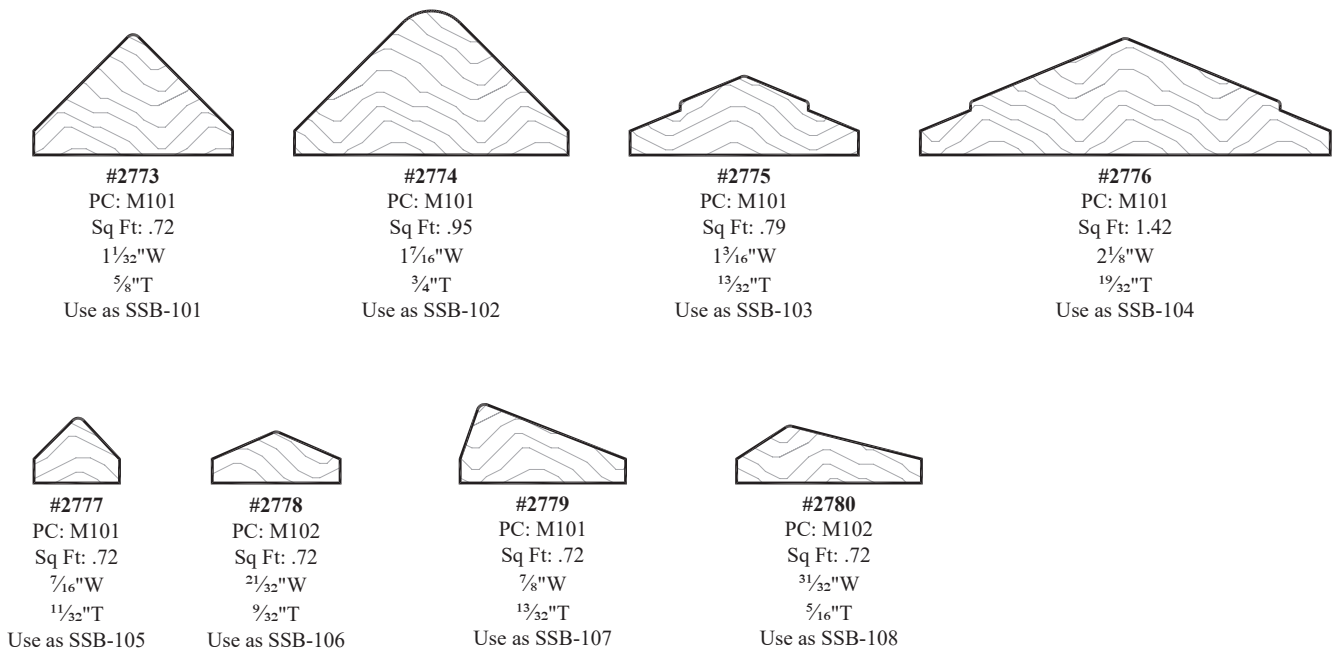

► For PRICING ► See Section N.9 in our current Wholesale Pricing Catalog.

#1049 Bar Rail Molding (Straight 8' Piece)

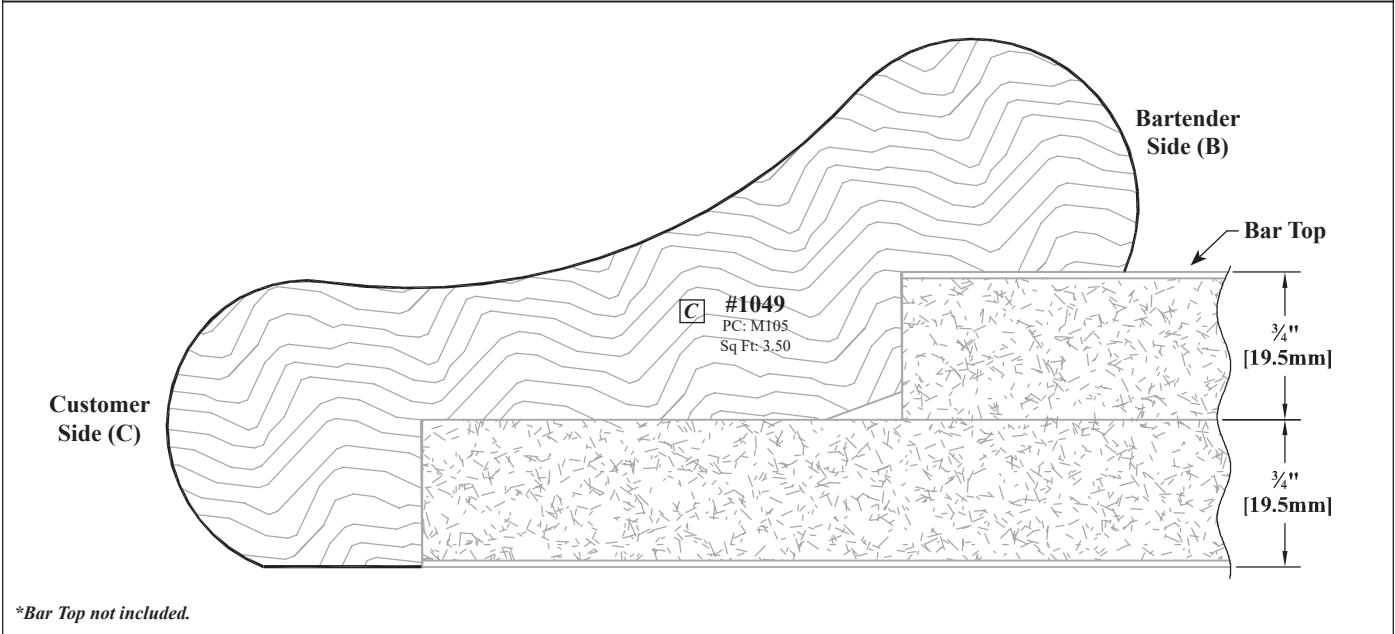

Radius Transition Moldings for #1049 Bar Rail

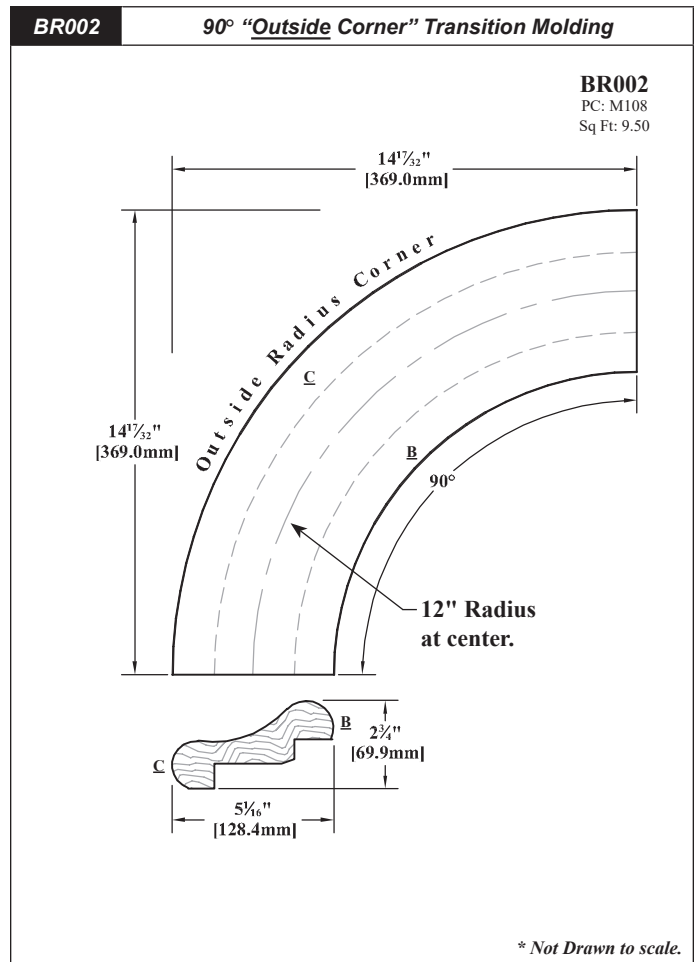
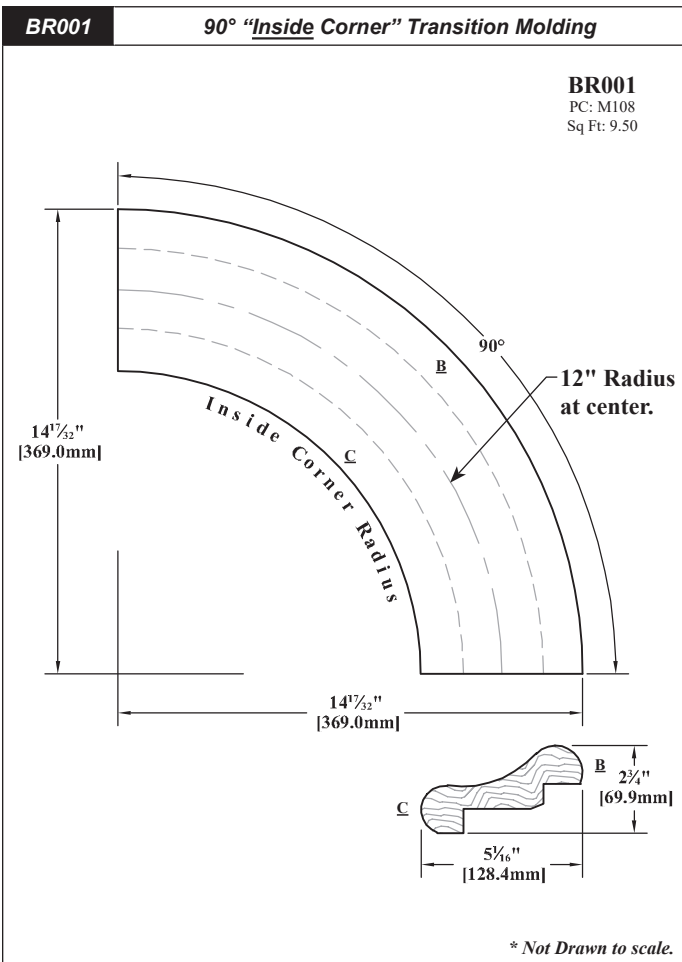

Continued on next page...

Radius Transition Moldings for #1049 Bar Rail...continued

BR003 45° "Inside Corner" Transition Molding

BR003
PC: M108
Sq Ft: 6.33

10⁷/₃₂" [260.9mm]
7⁷/₃₂" [198.9mm]
5¹/₁₆" [128.4mm]
2³/₄" [69.9mm]
12" Radius at center.

** Not Drawn to scale.*

BR004 45° "Outside Corner" Transition Molding

BR004
PC: M108
Sq Ft: 6.33

10⁷/₃₂" [260.9mm]
7⁷/₃₂" [198.9mm]
5¹/₁₆" [128.4mm]
2³/₄" [69.9mm]
12" Radius at center.

** Not Drawn to scale.*

#1049 Bar Rail Molding - Options

BR005 3/8" Thick End Cap

BR005
PC: KK100
Sq Ft: 2.0

3/8" [9.5mm]
2³/₄" [69.9mm]
3/2" [2.4mm]
4³/₃₂" [126.0mm]
5¹/₁₆" [128.4mm]

** Not Drawn to scale.*

#186544 Draw Bolt Rout (Includes Draw Bolt)

**** Assembly by customer. ****

** Not Drawn to scale.*

Continued on next page...

#869 Bar Rail Molding (Straight 8' Piece)

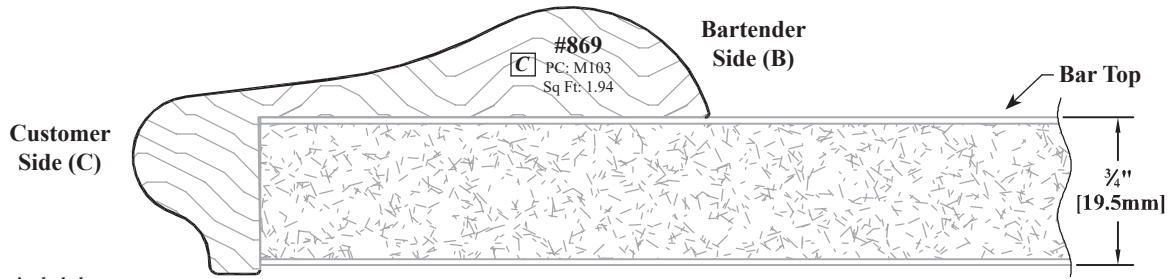

*Bar Top not included.

Radius Transition Moldings for #869 Bar Rail

BR006 90° "Inside Corner" Transition Molding

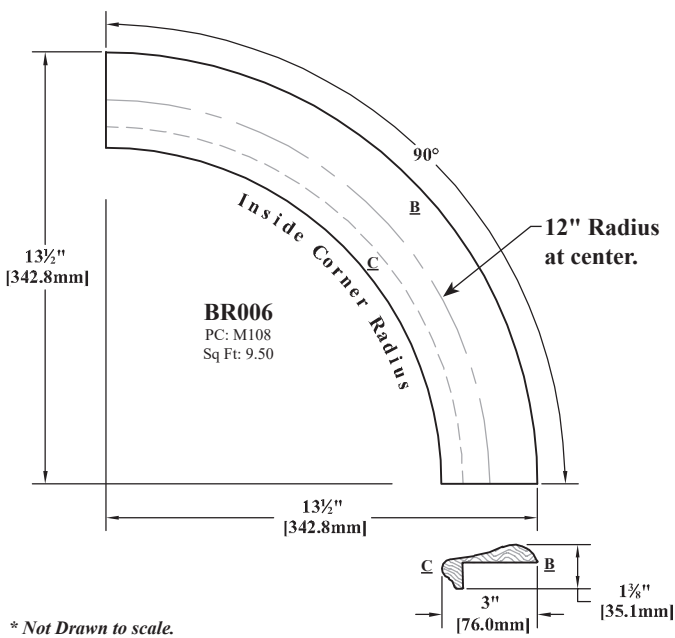

BR007 90° "Outside Corner" Transition Molding

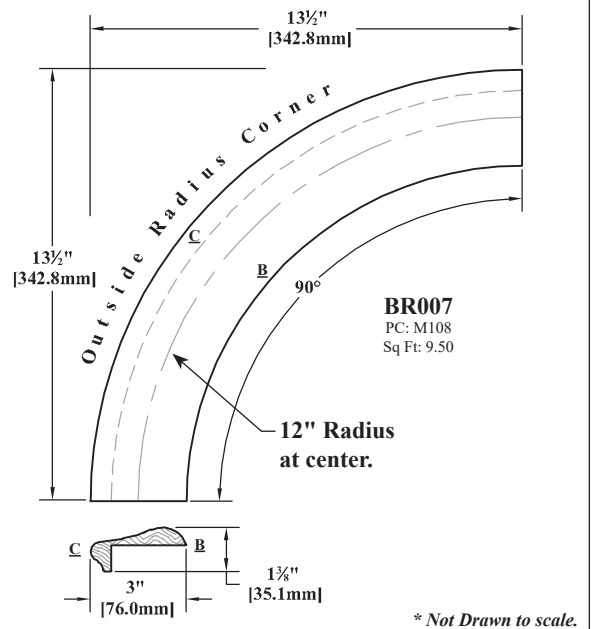

BR008 45° "Inside Corner" Transition Molding

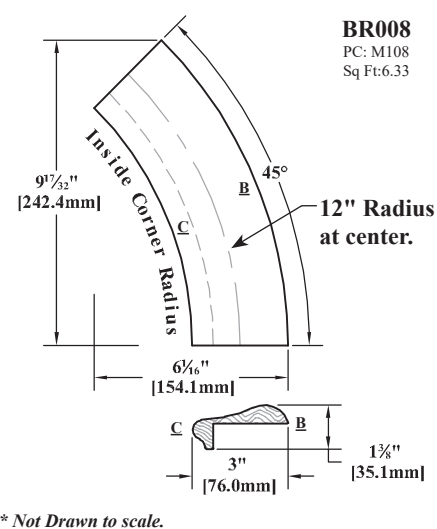

BR009 45° "Outside Corner" Transition Molding

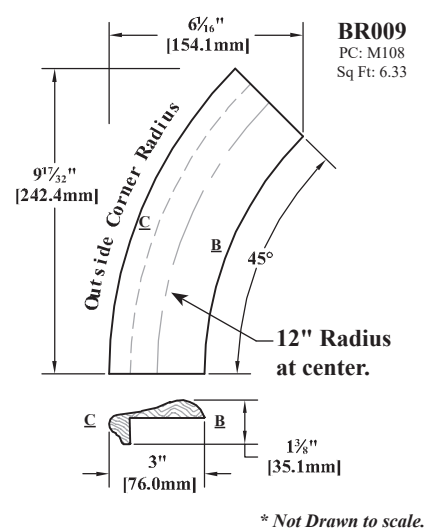

BR010 3/8" Thick End Cap

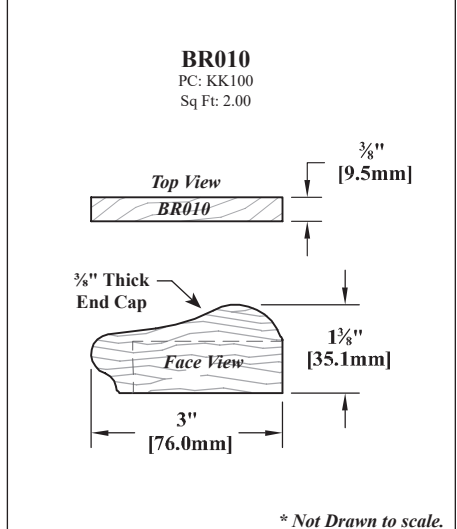

Continued on next page...

Bar Rail/Cap Molding

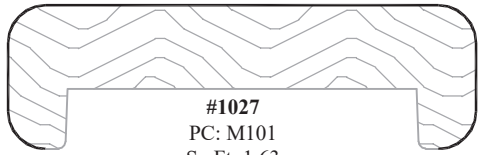

#1027
 PC: M101
 Sq Ft: 1.63
 2⁷/₁₆"W
 3/4"T

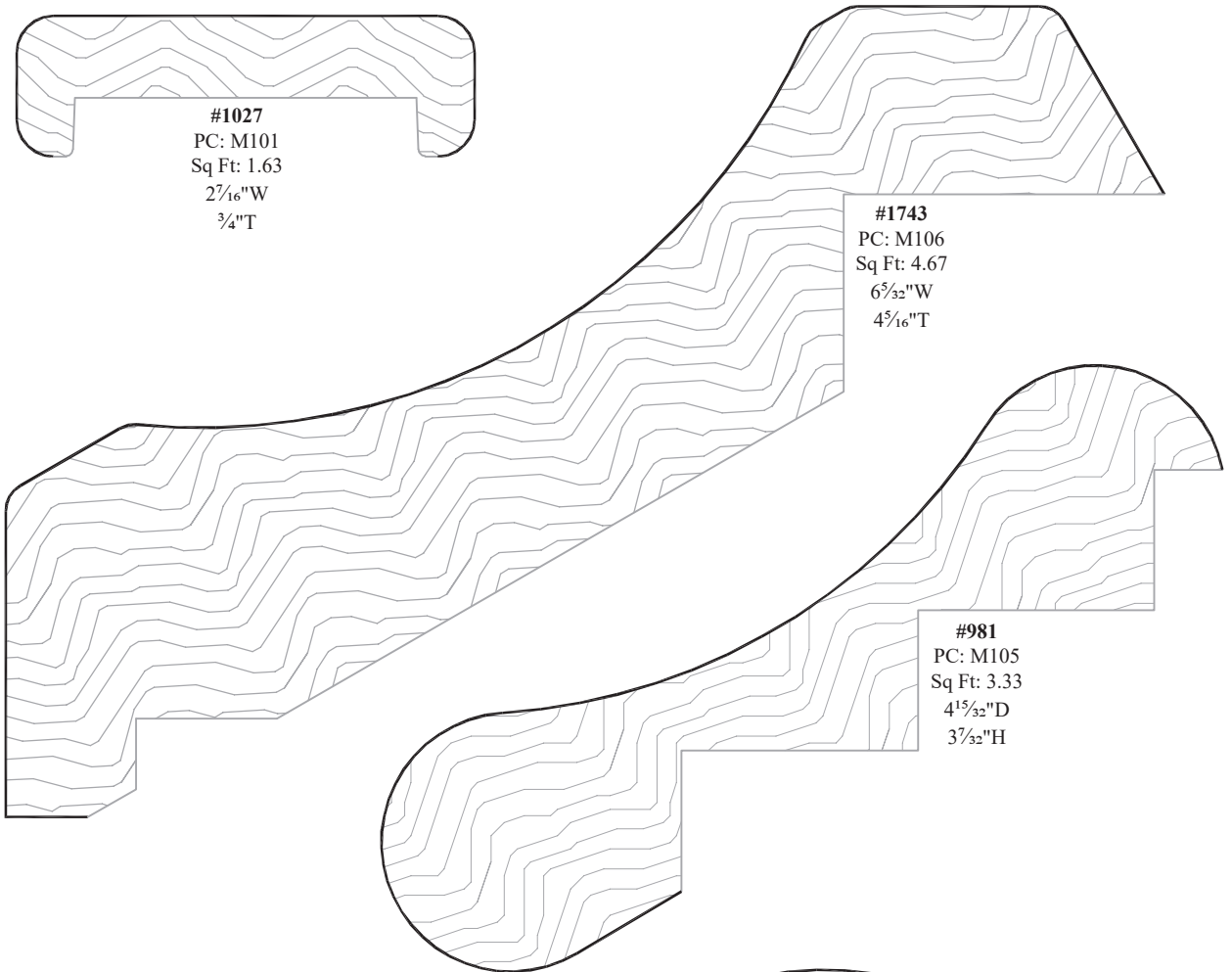

#1743
 PC: M106
 Sq Ft: 4.67
 6⁵/₃₂"W
 4⁵/₁₆"T

#981
 PC: M105
 Sq Ft: 3.33
 4¹⁵/₃₂"D
 3⁷/₃₂"H



#915
 PC: M103
 Sq Ft: 3.66
 5¹⁷/₃₂"W
 1¹/₁₆"T

Stemware Molding

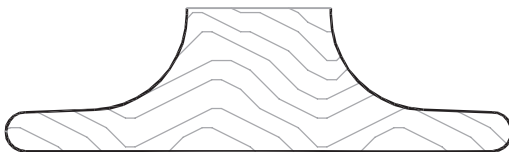

#388
 PC: M101
 Sq Ft: 1.76
 2³/₈"W
 3/4"T

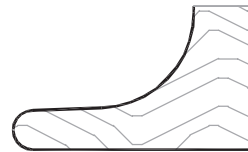

#1774
 PC: M101
 Sq Ft: .84
 1¹/₄"W
 3/4"T

Continued on next page...

Ordering & Pricing Notes: #869/#1049 Bar Rail Molding

Ordering Guidelines

1	Order Forms	Please use <i>Moldings & Miscellaneous Order Form (E•Z Form #5)</i> .
2	Ordering Information	Enter quantity, molding/part number and description.
Pricing		
1	Pricing	Please see <i>Section N.9</i> of our current Wholesale Pricing Catalog .

Technical Notes: #869/#1049 Bar Rail Molding

Finish Options (Chapter R)

1	Finishing	Only available unfinished.
2	MDF/3D Laminate	Not available with 3D Laminate (RTF).

Functional Options (Chapter F)

1	Draw Bolt Rout (Includes Draw Bolt)	WCI #186544: Used to connect two pieces of #1049 molding. Draw Bolt Routs are an option that can be added to the end of a straight 8' length of #1049 and to the Radius Transition Moldings. Bolts are included.
		Not available with #869 bar rail molding.
		To order bolt individually, without the rout, please use WCI #186536 .

General Information (Chapter A)

1	Assembly	Only available unassembled.
---	----------	-----------------------------

Material Options

1	Available Material	Only available in solid wood. Not available in raw MDF.
---	--------------------	---

Molding Options (Chapter N)

1	End Cap	End caps are an option that can be used to cap the finished end of a run of #869 or #1049 molding.
		BR010 can be used as a left or right end for #869.
		BR005 can be used as a left or right end for #1049.
		Only available shipped loose.

Sizes/Dimensions

1	Sizes	All part sizes are fixed.
---	-------	---------------------------

Wood Specie Options (Chapter S)

1	Available Wood Species	All of WalzCraft's standard solid wood species are available.
---	------------------------	---

BAR Rail Molding - END

Tambour Molding / Roll Top Desk Application

Roll Top / Appliance Garage Application*

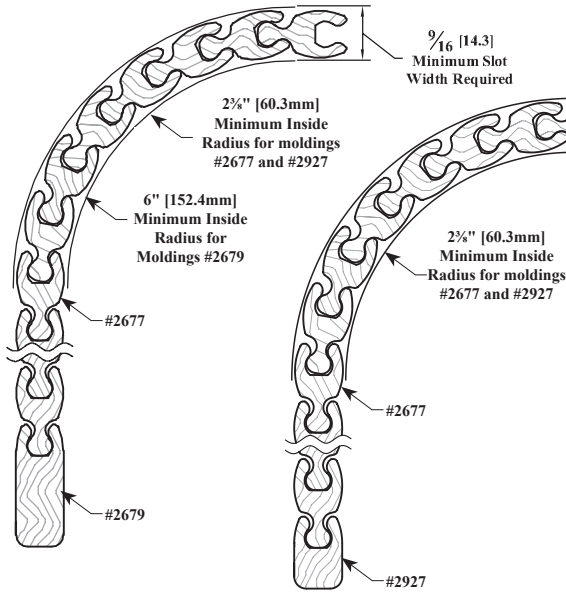

See notes in Section N.12 for more information.

Wainscot/Wall Panel Application*



*Application drawings are not shown at full scale.

*Individual moldings are drawn at full scale.

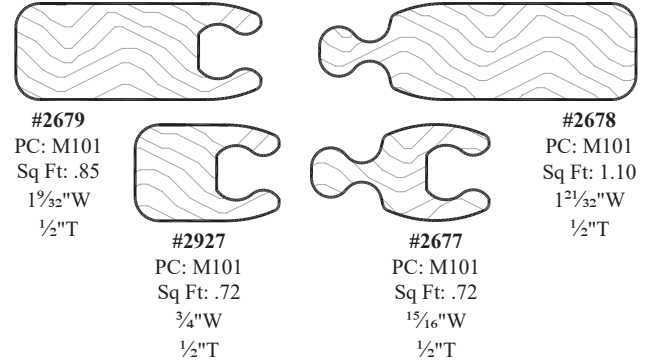
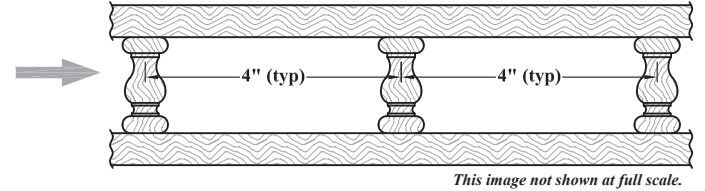
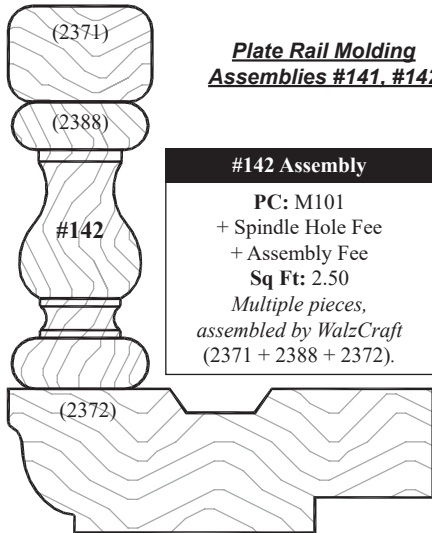
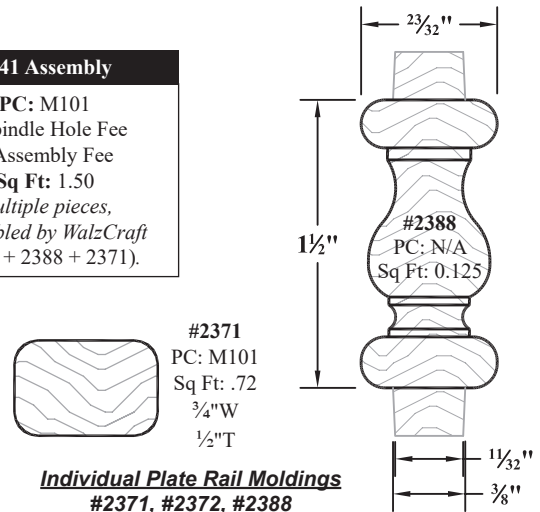

Plate Rail Molding / Assemblies



This image not shown at full scale.



Individual Plate Rail Moldings #2371, #2372, #2388

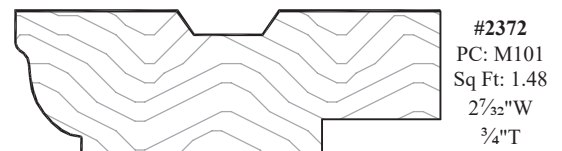

- Plate rail turned spindle #2388 is an outsourced item. It is available in Birch, Cherry, Maple-Hard and Oak-Red. See Section N.13 of our current Wholesale Pricing Catalog for pricing.
- For assemblies #141 and #142, spindles are placed 4" on center.
- Individual moldings #2371 and #2372 do not come pre-drilled for spindles.

► For PRICING ► See Section N.9 in our current Wholesale Pricing Catalog.

Arched Canopy Styles

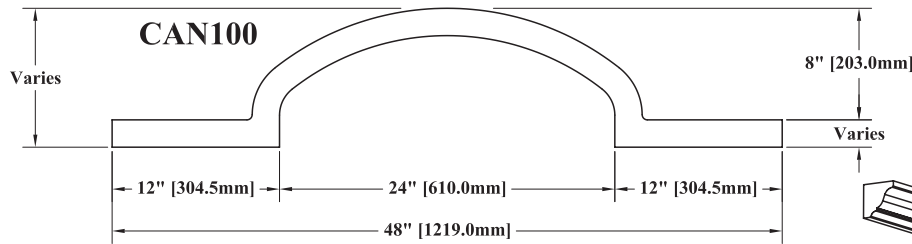

Below Arched Canopy Styles have been drawn using Arched Canopy Molding #2179.

#2179

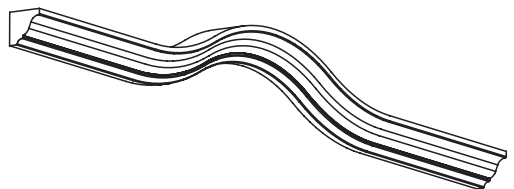
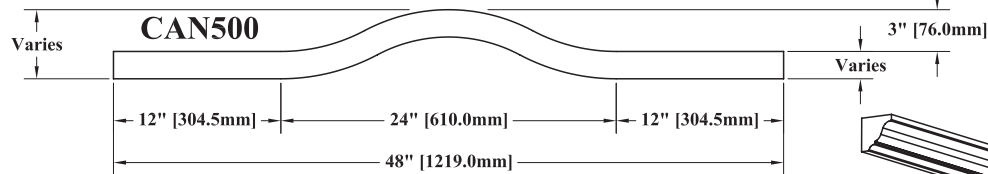
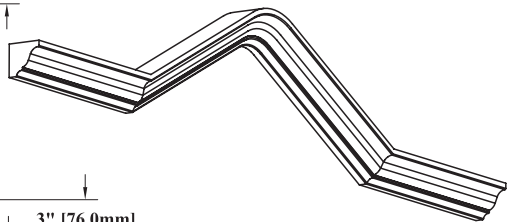
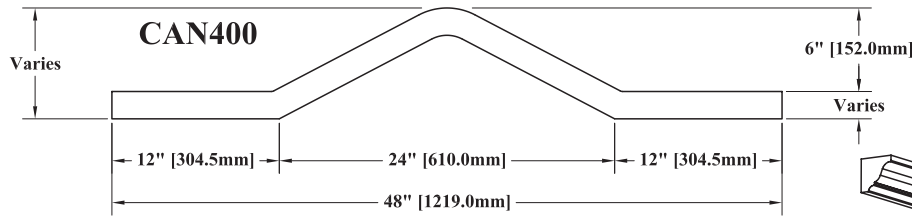
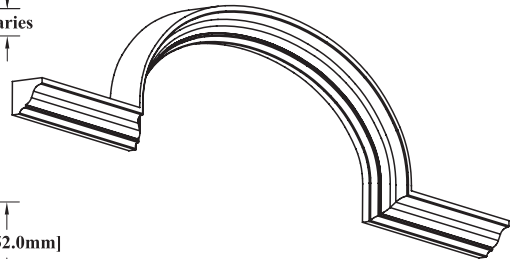
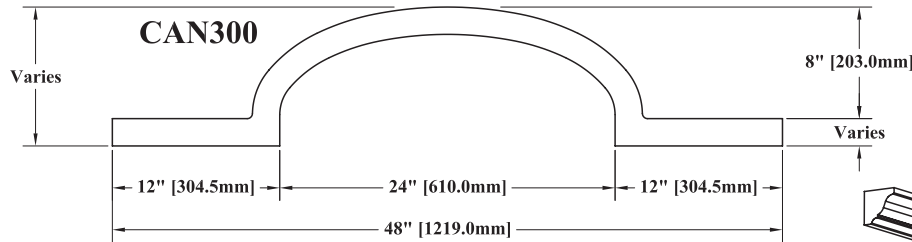
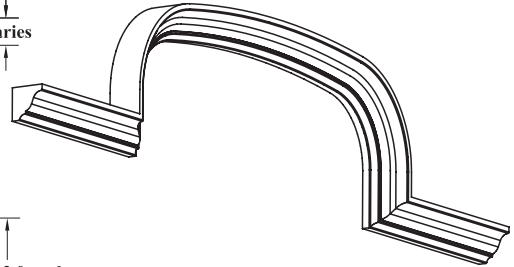
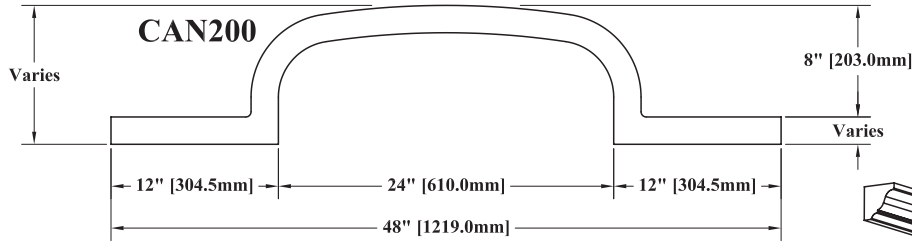
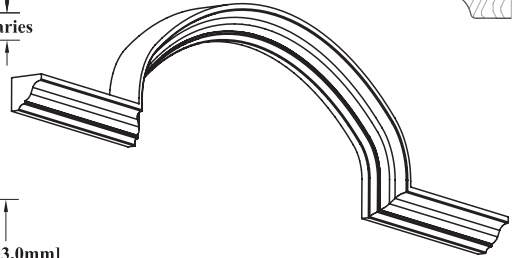

**Dimensions shown above are provided to give a sense of proportion. Actual dimensions will be determined by customer. See Sizes/Dimensions notes at end of section.*

****For Convex / Concave Crown Molding Options, Please see Section D.4 ****

► For PRICING ► See Section N.10 in our current Wholesale Pricing Catalog.

Arched Canopy Styles

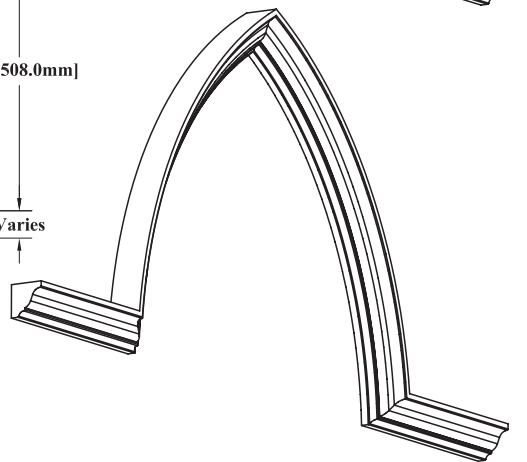
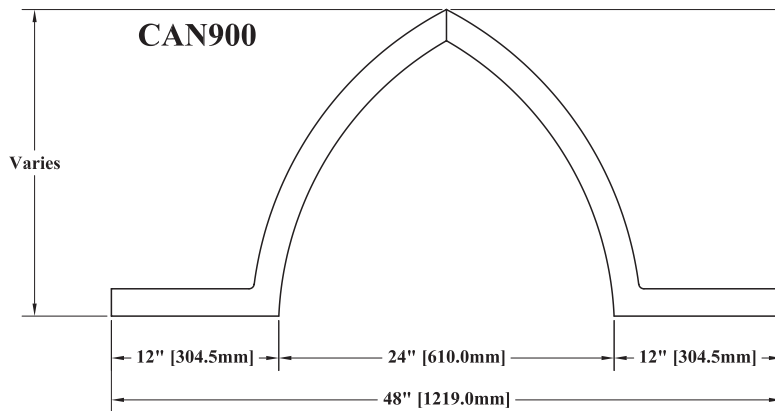
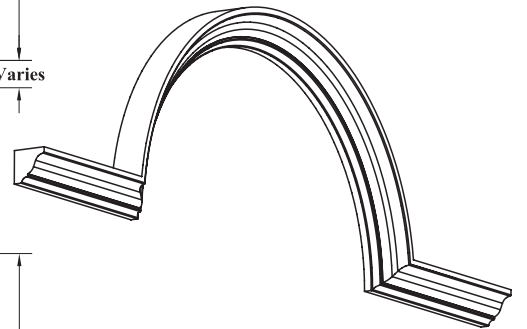
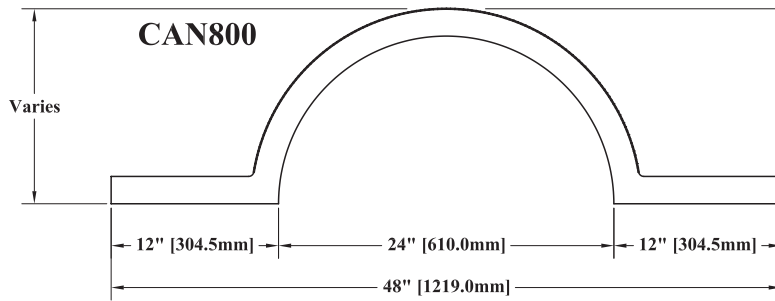
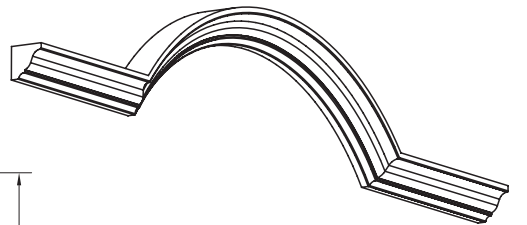
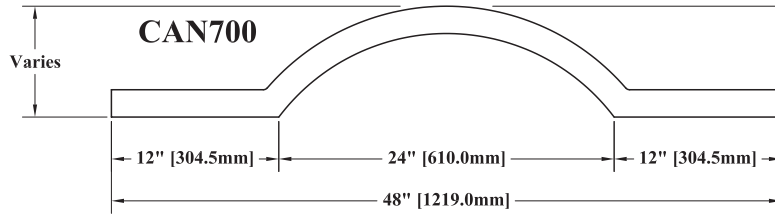
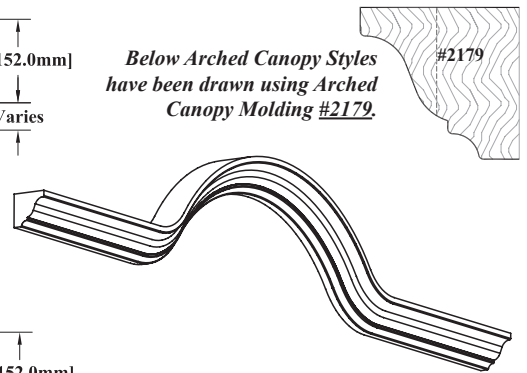
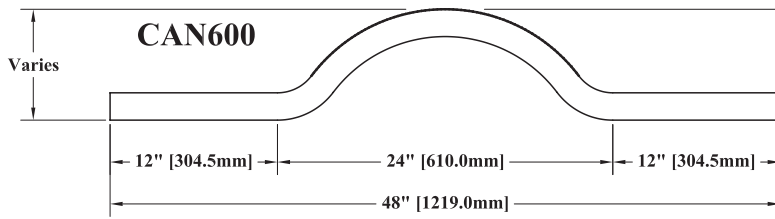

*Dimensions shown above are provided to give a sense of proportion. Actual dimensions will be determined by customer. See **Sizes/Dimensions** notes at end of section.

**For Convex / Concave Crown Molding Options, Please see Section D.4 **

► For PRICING ► See Section N.10 in our current Wholesale Pricing Catalog.

N

Arched Canopy Molding with Matching Crown Molding (#119)

Crown Molding

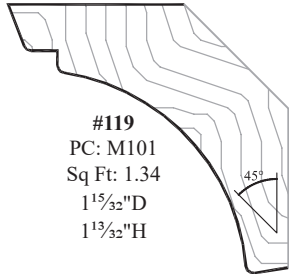

Straight Crown Block Molding

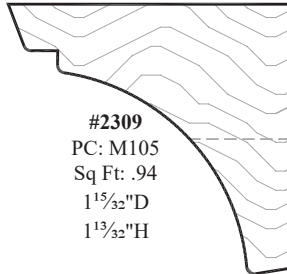

Arched Canopy Molding



Arched Canopy Molding with Matching Crown Molding (#383)

Crown Molding

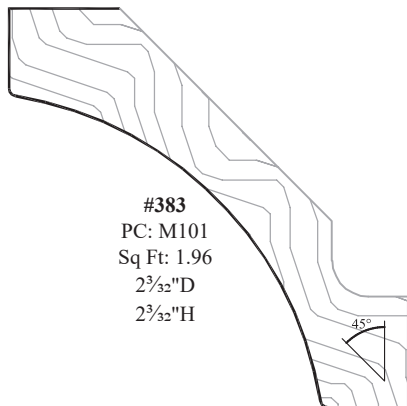

Straight Crown Block Molding

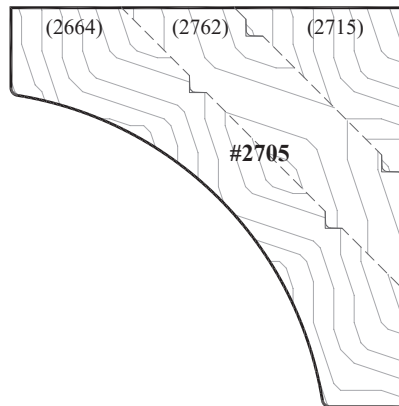

#2705 Assembly
 PC: M101 + 2 Assembly Fees
 + Post Assembly Machining Charge
 Sq Ft: 4.29
Price Class applies to straight stock molding only.
Three pieces assembled by WalzCraft.

Arched Canopy Molding

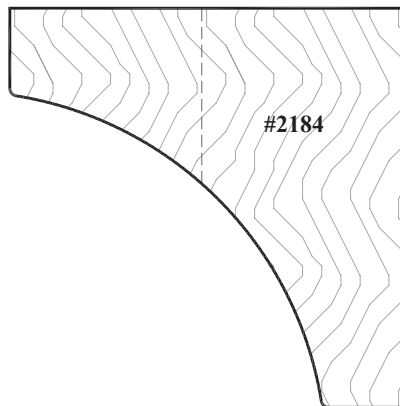

N

► **For PRICING** ► See Section **N.10** in our current Wholesale Pricing Catalog.

Arched Canopy Molding with Matching Crown Molding (#208)

Crown Molding

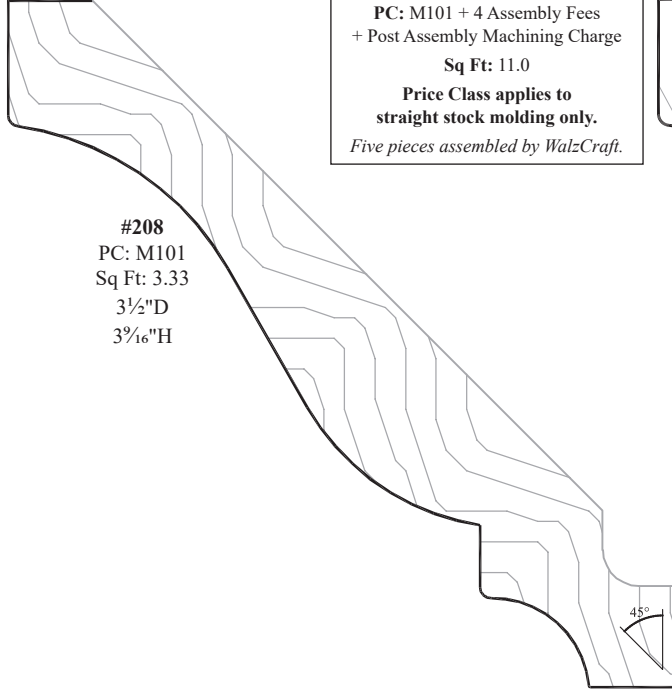

#2861 Assembly

PC: M101 + 4 Assembly Fees
+ Post Assembly Machining Charge

Sq Ft: 11.0

Price Class applies to
straight stock molding only.

Five pieces assembled by WalzCraft.

Straight Crown Block Molding

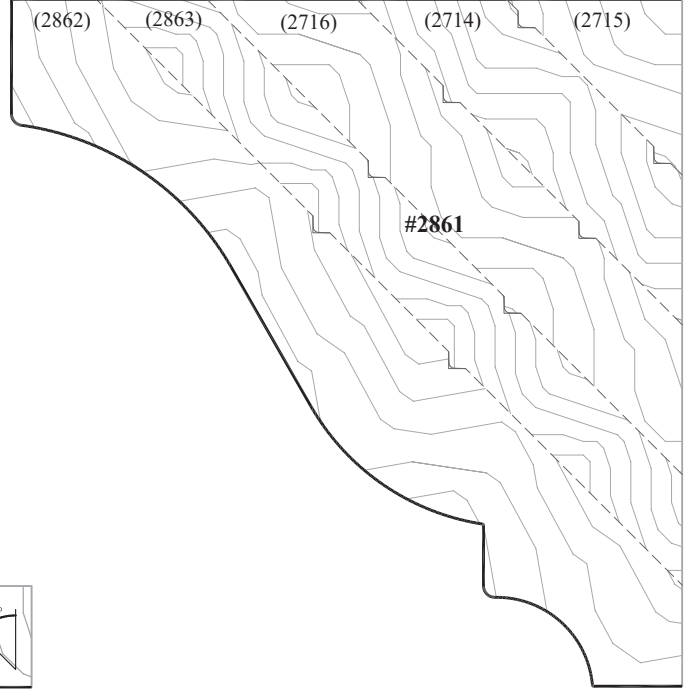

Arched Canopy Molding

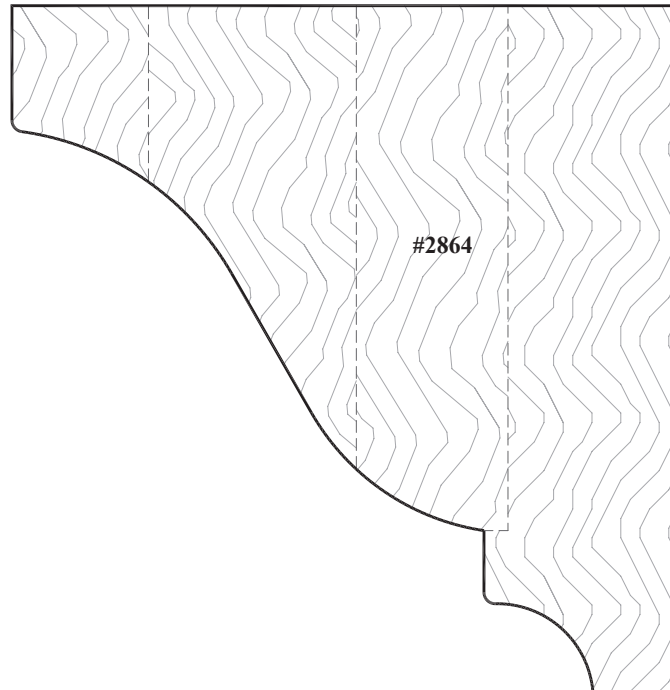

► For PRICING ► See Section N.10 in our current Wholesale Pricing Catalog.

Arched Canopy Molding with Matching Crown Molding (#942)

Crown Molding

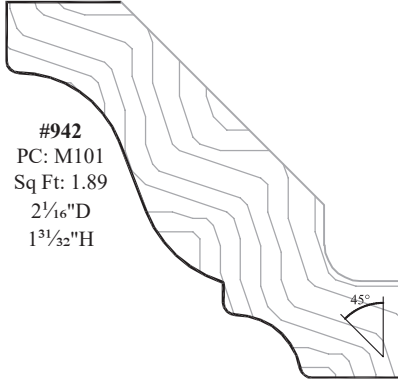

#942
 PC: M101
 Sq Ft: 1.89
 2 1/16" D
 1 31/32" H

Straight Crown Block Molding

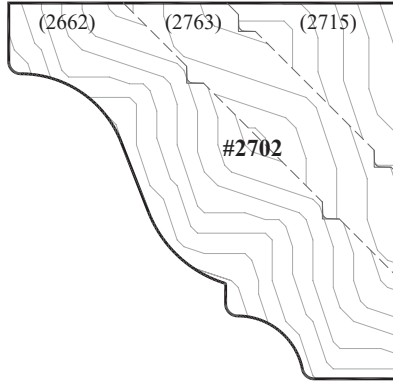

#2702

#2702 Assembly

PC: M101 + 2 Assembly Fees
 + Post Assembly Machining Charge

Sq Ft: 4.12

Price Class applies to straight stock molding only.

Three pieces assembled by WalzCraft.

Arched Canopy Molding

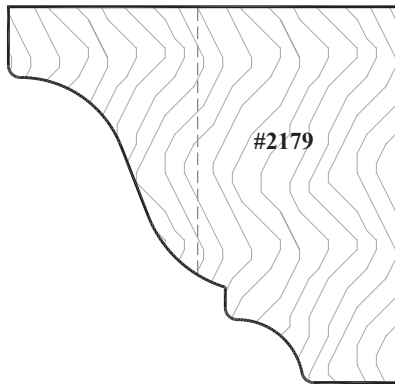

#2179

N

► **For PRICING** ► See Section **N.10** in our current Wholesale Pricing Catalog.

Arched Canopy Molding with Matching Crown Molding (#983)

Crown Molding

Straight Crown Block Molding

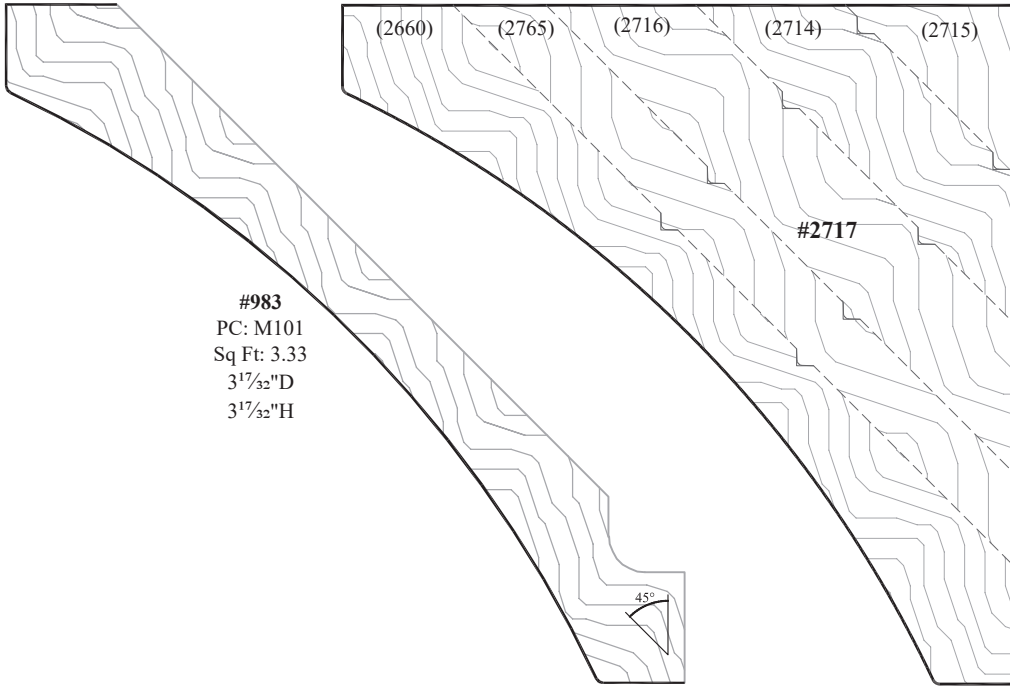

#983
 PC: M101
 Sq Ft: 3.33
 3¹⁷/₃₂"D
 3¹⁷/₃₂"H

#2717 Assembly

PC: M101 + 4 Assembly Fees
 + Post Assembly Machining Charge

Sq Ft: 10.92

Price Class applies to
 straight stock molding only.

Five pieces assembled by WalzCraft.

Arched Canopy Molding

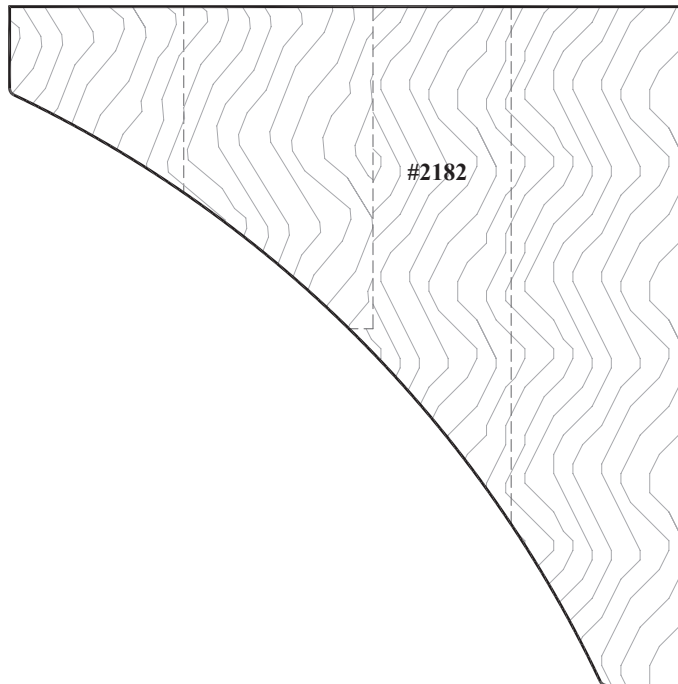

#2182

► For PRICING ► See Section N.10 in our current Wholesale Pricing Catalog.

Arched Canopy Molding with Matching Crown Molding (#1160)

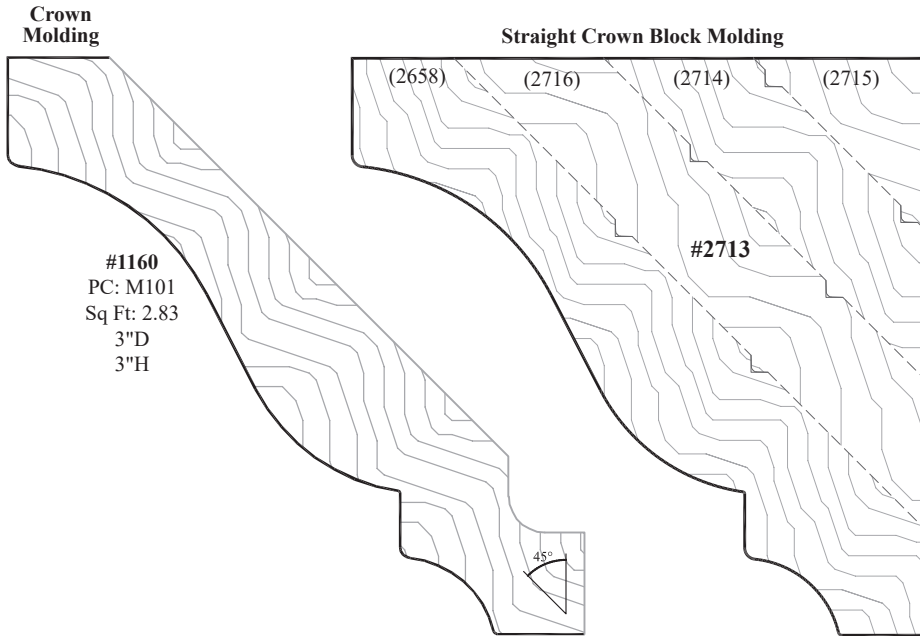

#2713 Assembly
PC: M101 + 3 Assembly Fees
+ Post Assembly Machining Charge
Sq Ft: 7.63
Price Class applies to
straight stock molding only.
Four pieces assembled by WalzCraft.

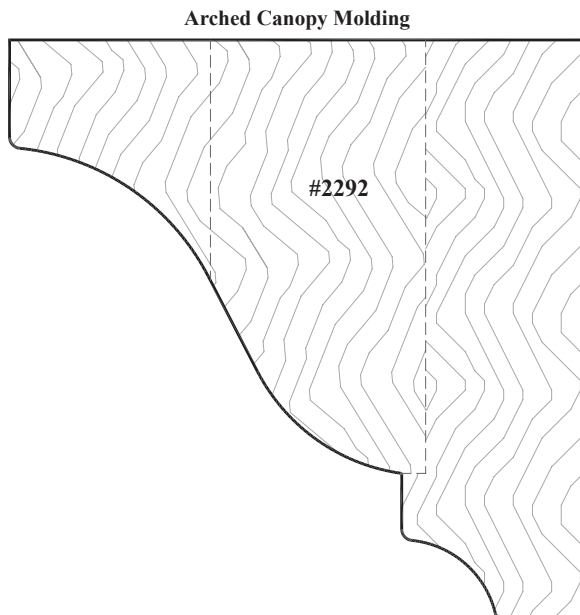

► **For PRICING** ► See Section **N.10** in our current Wholesale Pricing Catalog.

Arched Canopy Molding with Matching Crown Molding (#1183)

Crown Molding

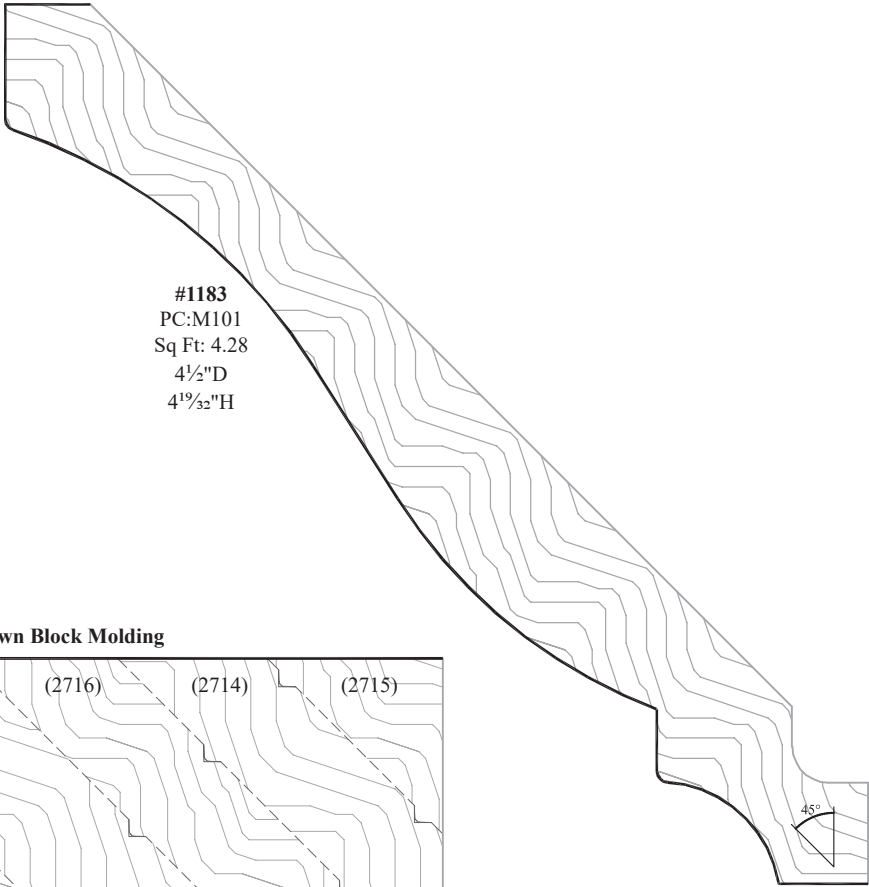

#1183
 PC:M101
 Sq Ft: 4.28
 4½"D
 4¹⁹/₃₂"H

Straight Crown Block Molding

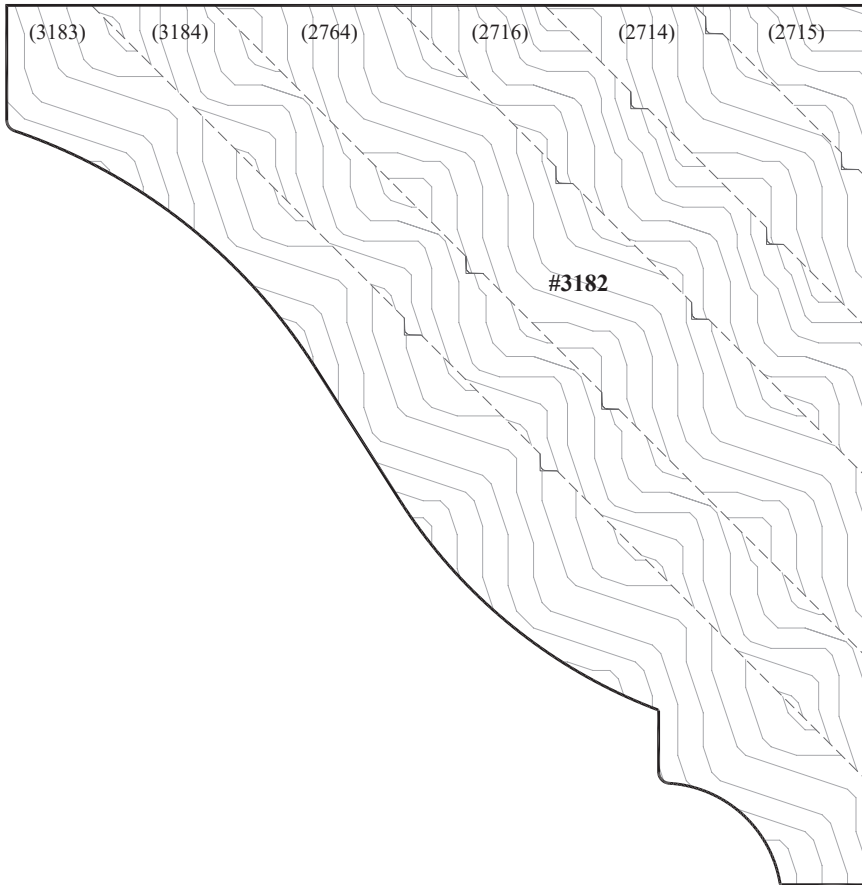

#3182

#3182 Assembly

PC: M101 + 5 Assembly Fees
 + Post Assembly Machining Charge

Sq Ft: 16.11

Price Class applies to
 straight stock molding only.

Six pieces assembled by WalzCraft.

Molding Continued on Next Page

► For PRICING ► See Section N.10 in our current Wholesale Pricing Catalog.

Arched Canopy Molding with Matching Crown Molding (#1183)...continued

Arched Canopy Molding

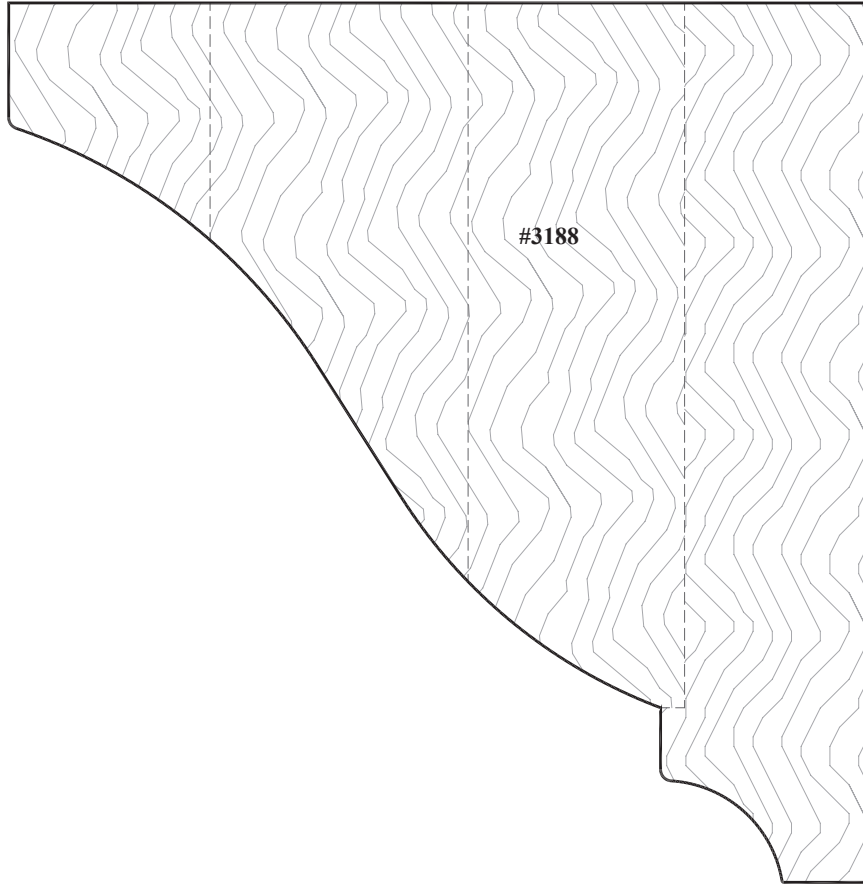

N

Arched Canopy Molding with Matching Crown Molding (#1358)

Crown Molding

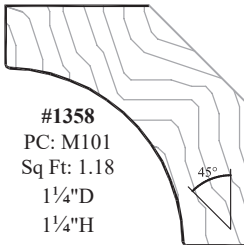

Straight Crown Block Molding

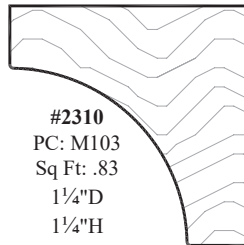

Arched Canopy Molding

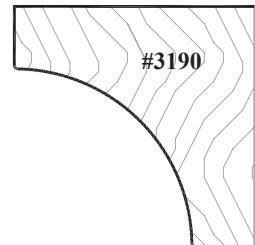

► For PRICING ► See Section N.10 in our current Wholesale Pricing Catalog.

Arched Canopy Molding with Matching Crown Molding (#1860)

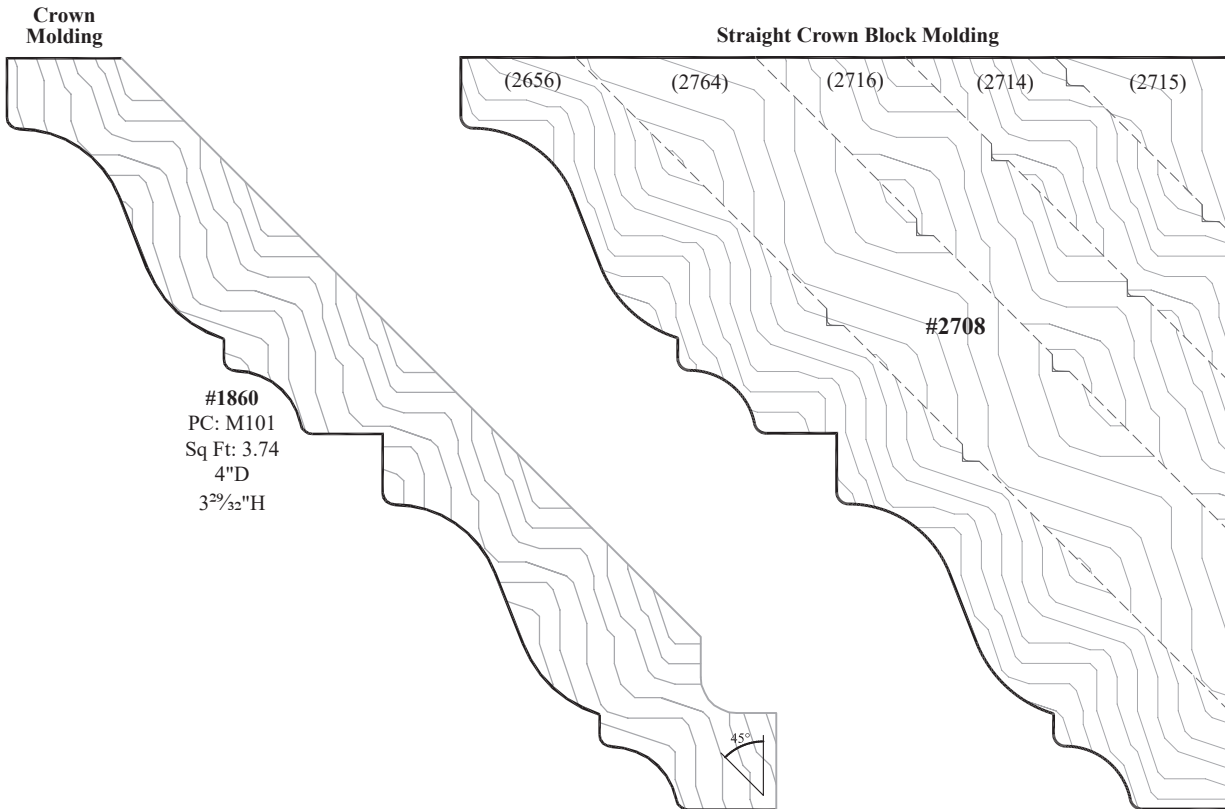

#1860
 PC: M101
 Sq Ft: 3.74
 4"D
 3²⁹/₃₂"H

#2708

Arched Canopy Molding



#2175

#2708 Assembly

PC: M101 + 4 Assembly Fees
 + Post Assembly Machining Charge

Sq Ft: 11.75

**Price Class applies to
 straight stock molding only.**

Five pieces assembled by WalzCraft.

► **For PRICING** ► See Section **N.10** in our current Wholesale Pricing Catalog.

Arched Canopy Molding with Matching Crown Molding (#2253)

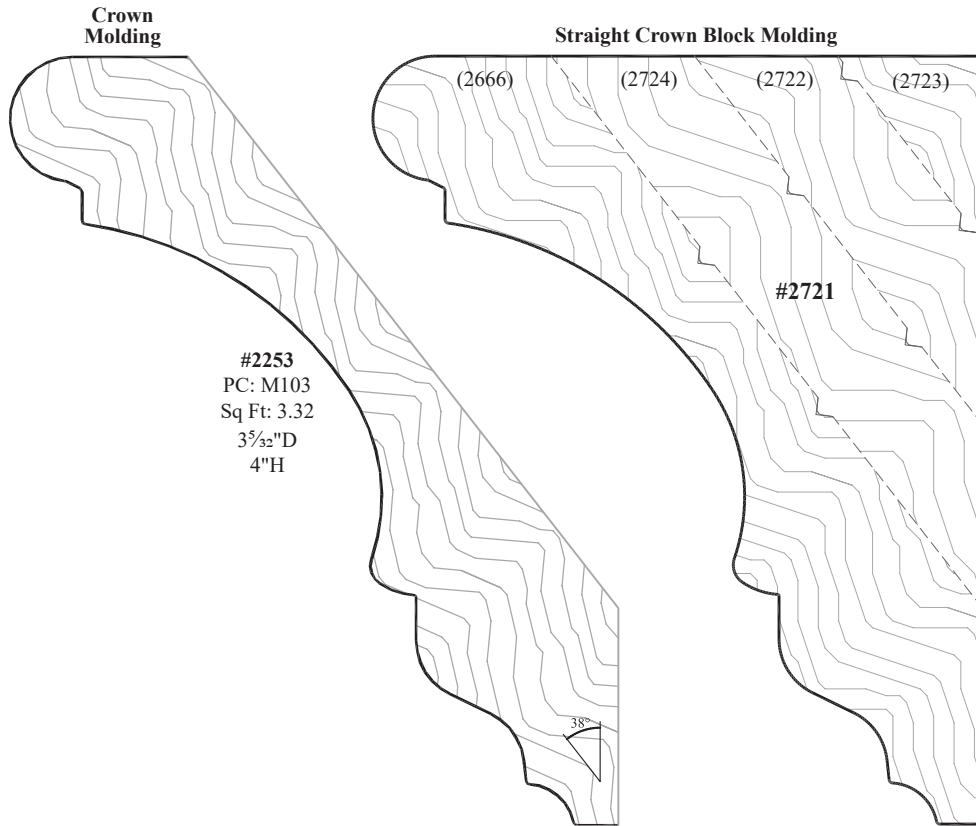

#2253
 PC: M103
 Sq Ft: 3.32
 3⁵/₃₂"D
 4"H

#2721 Assembly

PC: M103 + 3 Assembly Fees
 + Post Assembly Machining Charge

Sq Ft: 8.17

Price Class applies to
 straight stock molding only.

Four pieces assembled by WalzCraft.

Arched Canopy Molding

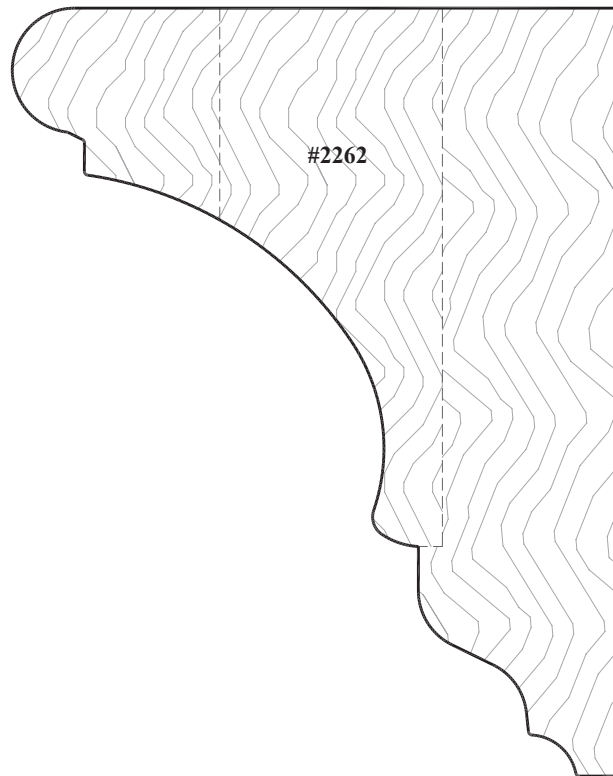

#2262

► For PRICING ► See Section N.10 in our current Wholesale Pricing Catalog.

Arched Canopy Molding with Matching Crown and Convex/Concave Molding

Crown Molding	Straight Crown Block Molding	Arched Canopy Molding	Convex/Concave Molding
119	2309	3175	3176
208	2861	2864	3177
383	2705	2184	3178
942	2702	2179	3179
983	2717	2182	3180
1160	2713	2292	3181
1183	3182	3188	3189
1358	2310	3190	3191
1860	2708	2175	3192
2253	2721	2262	3193

Ordering & Pricing Notes: Arched Canopy Styles / Molding

Ordering Guidelines

1	Order Forms	Please use <i>Molding & Miscellaneous Order Form (E•Z Form #5)</i> .
2	Ordering Information	<ol style="list-style-type: none"> 1) Select the Arched Canopy Style #. See examples at the front of this section. 2) Select the Arched Canopy Molding #. 3) Reference the line drawing in the Sizes / Dimensions table below. <ul style="list-style-type: none"> • Fax your line drawing with all relative dimensions, along with your order forms, to our Customer Support Team or email drawings to: customersupport@WalzCraft.com.
Pricing		
1	Pricing	<p>Please see <i>Section N.10</i> of our current Wholesale Pricing Catalog.</p> <p>A quote will be submitted to you for your approval prior to proceeding with your order.</p>

Technical Notes: Arched Canopy Styles / Molding

Material Options

1	Maple - Hard vs. Soft	For quality reasons, product requiring CNC machining will not be available in any Maple-Hard/Soft-Mixed species or Maple-Soft species. These items should instead be ordered in any of our Maple-Hard species.
---	-----------------------	--

Molding Options (Chapter N)

1	Arched Canopy Styles: Molding Profile Options	<p>Arched Canopy Styles are only available with the following Arched Canopy Molding Profiles: 2175, 2179, 2182, 2184, 2262, 2292, 2864, 3175, 3188, 3190.</p> <p>These arched canopy moldings and their matching crown moldings are also available in straight 8' [2438.4mm] lengths to use throughout your project. Both 8' [2438.4mm] straight stock molding profiles are shown.</p>
---	---	---

Sizes/Dimensions

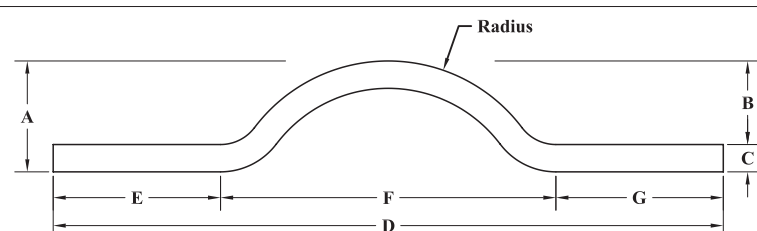
1	Customer Specified Relative Dimensions	<p>When ordering, please specify the following dimensions:</p> <ul style="list-style-type: none"> • A = Overall Height (B + C) • B = Canopy Rise • C = Molding Height • D = Overall Width (E + F + G) • E = Width of Flat to the Left • F = Width of Center Opening • G = Width of Flat to the Right • Radius of Arch  <p>** You will be provided with a CAD drawing for final approval prior to proceeding with your order.</p>
2	Drawing Scale	Arched Canopy moldings and matching crown moldings in <i>Section N.10</i> are drawn at full scale.

► For PRICING ► See Section N.10 in our current Wholesale Pricing Catalog.

Precision Molded 3/4" Wood Flooring

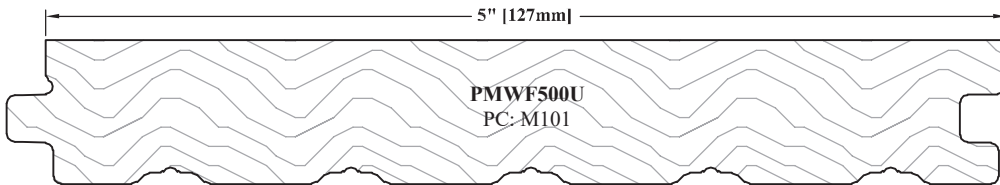
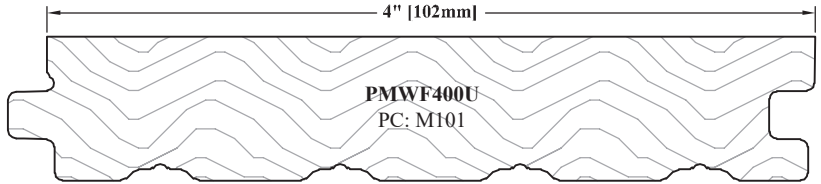
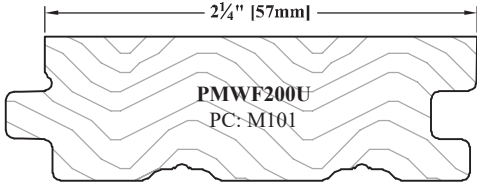
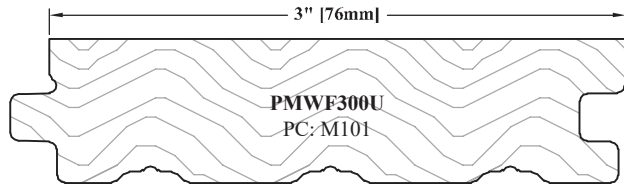
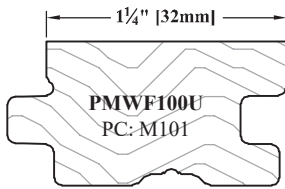

3/4" Wood Flooring Transition Moldings

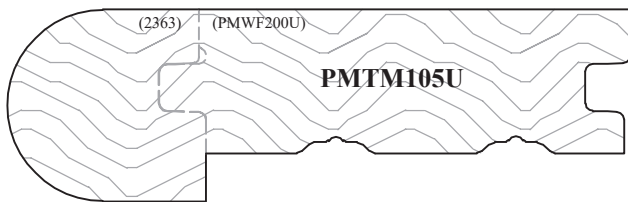
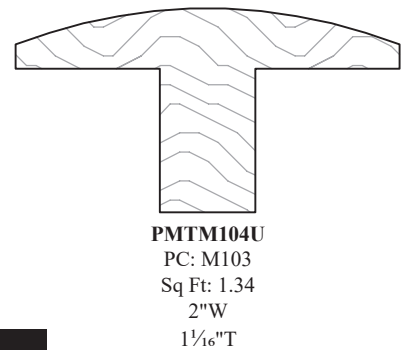
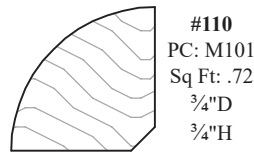
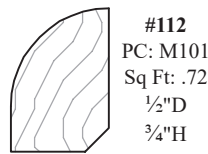
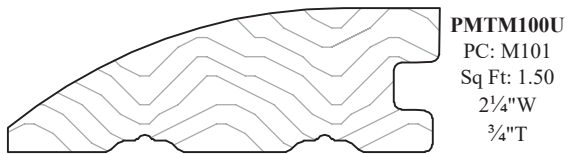

#PMTM105U Assembly
 PC: M103 + 2 Assembly Fees
 + Post Assembly Machining Charge
Sq Ft: 2.30
 Price Class applies to
 straight stock molding only.
 Two pieces assembled by WalzCraft.

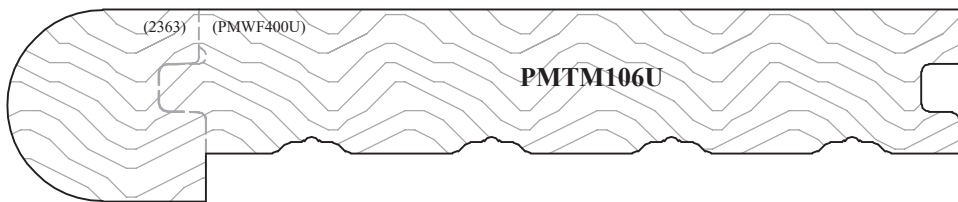

#PMTM106U Assembly
 PC: M103 + 2 Assembly Fees
 + Post Assembly Machining Charge
Sq Ft: 3.47
 Price Class applies to
 straight stock molding only.
 Two pieces assembled by WalzCraft.

► For PRICING ► See Section N.11 in our current Wholesale Pricing Catalog.

Molding Options

Precision Molded Wood Flooring

Precision Molded 3/8" Wood Flooring

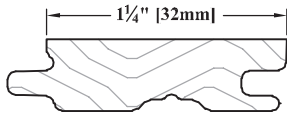

PMWF150U
PC: M102

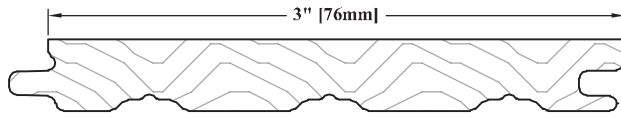

PMWF350U
PC: M102

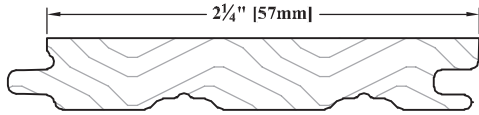

PMWF250U
PC: M102

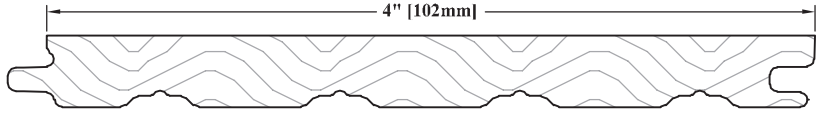

PMWF450U
PC: M102

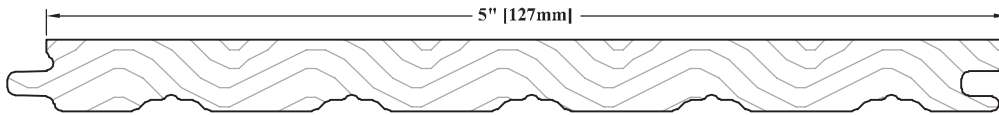

PMWF550U
PC: M102

3/8" Wood Flooring Transition Moldings



PMTM107U
PC: M102
Sq Ft: 1.34
2"W
3/8"T



#112
PC: M101
Sq Ft: .72
1/2"D
3/4"H

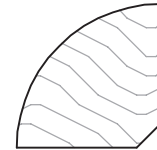

#110
PC: M101
Sq Ft: .72
3/4"D
3/4"H

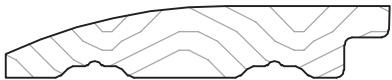

PMTM108U
PC: M102
Sq Ft: 1.34
2"W
3/8"T

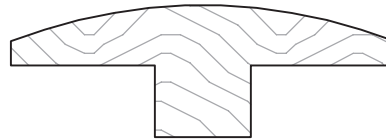

PMTM111U
PC: M101
Sq Ft: 1.84
2"W
1/16"T

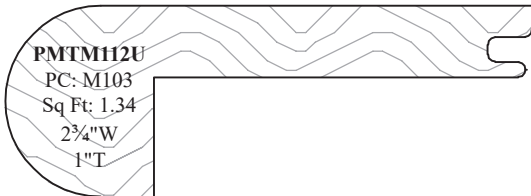

PMTM112U
PC: M103
Sq Ft: 1.34
2 3/4"W
1"T

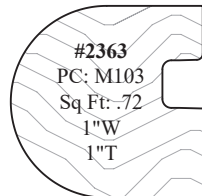

#2363
PC: M103
Sq Ft: .72
1"W
1"T

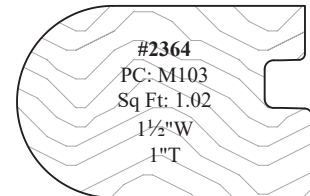

#2364
PC: M103
Sq Ft: 1.02
1 1/2"W
1"T

► For PRICING ► See Section N.11 in our current Wholesale Pricing Catalog.

Precision Molded Wood Flooring Price Classes, # of Sq.Ft. per Lineal Foot

Molding #	Price Class	Sq.Ft. / Lineal Foot	Lineal Feet / One Square Foot
PMWF100U	M101	0.121	9.60
PMWF200U	M101	0.205	5.34
PMWF300U	M101	0.268	4.00
PMWF400U	M101	0.350	3.00
PMWF500U	M101	0.434	2.40
PMWF150U	M102	0.121	9.60
PMWF250U	M102	0.205	5.34
PMWF350U	M102	0.268	4.00
PMWF450U	M102	0.350	3.00
PMWF550U	M102	0.434	2.40

Ordering & Pricing Notes: Wood Flooring

Ordering Guidelines

1	Order Forms	Please use <i>Molding & Miscellaneous Order Form (E•Z Form #5)</i> .
2	Ordering Information	Total square footage must be supplied. <i>(Note, your total square footage should accommodate a waste factor.)</i>

Pricing

1	Pricing	Please see <i>Section N.11</i> of our current Wholesale Pricing Catalog .
---	---------	--

Technical Notes: Wood Flooring

Finish Options (Chapter R)

1	Finishing	Available unfinished only. WalzCraft's "cabinet grade finish" is <i>not</i> engineered for wood flooring.
---	-----------	--

General Information (Chapter A)

1	Sanding	Sanded to 180 grit. WalzCraft's precision molded wood flooring requires minimal sanding after installation. Moldings will also be end milled.
---	---------	---

Sizes / Dimensions

1	Drawings	Moldings are drawn at full scale.
2	Precision Molded Flooring	Precision molded wood flooring is sold in random lengths from 36" [914.4mm] to 96" [2438.4mm].
3	Transition Molding	Sold in 8' [2438.4mm] lengths, with 93" [2362.2mm] guaranteed to be usable. Moldings over 6" [152.4mm] in width may be produced from a glued up panel, due to lumber availability.

Precision Molded Wood Flooring - END

► For PRICING ► See Section N.11 in our current Wholesale Pricing Catalog.

Ordering & Pricing Notes: Molding

Ordering Guidelines

1	Order Forms	Please use <i>Molding & Miscellaneous Order Form (E•Z Form #5)</i> .
Pricing		
1	Pricing	Please see <i>Section N.12</i> of our current Wholesale Pricing Catalog .

Technical Notes: Molding

Convex/Concave Options (Chapter D)

1	Curved Products	The C indicates profiles that are available when ordering convex/concave products.
---	-----------------	---

Finish Options (Chapter R)

1	Finishing	<p>Moldings will be considered a Two-Sided (2S) finished product (<i>Chapter R</i>). This includes solid wood refacing stock (<i>Section N.2</i>). The backs will be sealed while the face and all edges will be sealed and top coated.</p> <p>Please see individual drawings for location of clear sealer vs. clear sealer/clear top coat.</p> <ul style="list-style-type: none"> The thick black lines represent the face/edges (sealer/top coat) while the thinner gray lines represent the back (sealer only). These locations are also applicable to standard SolidTone® applications. The thick black lines represent the face/edges (SolidTone® Topcoat and SolidTone® Primer) while the thinner gray lines represent the back (SolidTone® Primer Only). For SolidTone® Woodgrain applications, the entire surface (face, edges, back) will be comprised of SolidTone® Topcoat only.
2	Stemware Molding	When “Cut to Length” stemware molding is prefinished by WalzCraft, the ends will also be finished.
3	3D Laminate (RTF)	<p>★ = Products available with 3D Laminate (RTF).</p> <p>3D Laminate (RTF) moldings use the same foil colors that are used on the doors, so the color match is exact.</p> <p>Only the face of the molding is covered with 3D Laminate (RTF) foil. The back is unfinished wood.</p> <p>The maximum length for moldings with 3D Laminate (RTF) is 96" [2438.4mm].</p>



General Information (Chapter A)

1	Sanding	Moldings are sanded to 180 grit.
2	“Passes”	<p>“Passes” refers to the number of times the 8' length of rough stock lumber is run through the molder and/or secondary machinery to complete the molding.</p> <p>All moldings are considered one pass moldings unless specified otherwise.</p> <p>Upcharges will apply for all moldings requiring more than one pass.</p>

Material Options

1	3D Laminate (RTF)	For quality reasons, 3D Laminate (RTF) moldings have a solid wood core (Paint Grade Maple).
---	-------------------	---

Molding Options (Chapter N)

1	Radiused Molding	The R indicates moldings that can be radiused to follow the contour of a shaped rail.
2	Fastener Relief Cut	FRC = Fastener Relief Cut. See <i>page N.1.3</i> for assembly detail. Hole drilling and wood screw by customer. FRC is not applicable with Convex/Concave or Canopy moldings.
3	Column Wraps	Column Wraps can be used as transition moldings between cabinets of different depths.
4	Molding #2160	When adding an accent molding to #2160 (<i>Section N.1</i>), the following work best: #239, 810, 812, 816, 818, 829, 832, 914, 922, 955, 956, 1043, 1164, 1203, 1398, 1732, 1810, 1815, 1816, 1821, 1895, 1902, 1911, 1928, 1971, 1998, 2008, 2044.

Continued on next page...

► For PRICING ► See Section N.12 in our current Wholesale Pricing Catalog.

Technical Notes: Molding...continued

Sizes/Dimensions

1	Molding Drawings	Solid wood moldings are drawn to actual size and Most molding are sold in 8' [2438.4mm] lengths. • 93" [2362.2mm] is guaranteed to be usable.
2	Small Moldings - LF	Certain small moldings throughout <i>Chapter N</i> are sold by the lineal foot in random lengths from 3' to 8'. • These small moldings will be identified with "LF" after the molding number (example: #2122-LF) • Please indicate the total lineal feet required in the "Description" column on the order form. • Minimum order of 8 lineal feet.
3	Random Length Molding Program	If your project requires 200 lineal feet or more of the same molding (and species), you can take advantage of our Random Length Molding Program. • Available random lengths from 3'-93", 3'-8' or 3'-12'. • Please indicate the total lineal feet required in the "Description" column on the order form. • When measuring random length moldings, we round down to the next nearest ½ foot. • Random lengths that range from 3' to 12' must be either picked up or shipped via common carrier. • Lengths greater than 8' [2438.4mm] are subject to availability. ◦ Note that the choice of wood species and grade can impact the availability of lengths greater than 8'. Total lineal foot quantity of random length molding will be 90% usable • Use Moldings Shorts program if under minimum quantity.
4	Molding Shorts program	When working with solid wood, occasionally defects are exposed through the manufacturing process that will not allow us to sell the molding as a clear 8' Select/Premium or Natural/Standard Grade. We are sometimes left with 3' - 7' of usable material. Part of our mission is to use our materials and resources in the most efficient manner, which is why we offer the availability of 3' - 7' moldings through this program. As an incentive, there will be a discount offered if 3' - 7' moldings are available.
5	Molding Over 8' in Length	For those occasions when you need a molding longer than 8', we will do our best to produce those lengths up to 12' long. • Lengths greater than 8' [2438.4mm] are subject to availability. • The choice of wood species and grade can impact the availability of lengths greater than 8' [2438.4mm]. • Please contact our Customer Support Team, and ask that they research material availability and wait-times. • Please see "Usable Molding Lengths" chart below for minimum usable material based on length ordered.
6	Molding Widths Over 6"	Due to lumber availability, moldings over 6" [152.4mm] wide may be produced from glued up panels.
7	Usable Molding Lengths	WalzCraft offers standard 8' [2438.4mm] long moldings. • Upon request and availability, we also manufacture moldings from 9' to 16' in even foot increments. • In all cases, WalzCraft will ship a molding that is at a minimum 97% usable, rounded down to the nearest inch. • Please see "Usable Molding Lengths" chart below for minimum usable material based on length ordered.
8	Stemware Molding	Stemware moldings #388 & #1774 are available Cut-to-Length (minimum of 3" [76.2mm]).
9	Round Column Wrap Molding	Round Column Wrap moldings are available in individual 8' lengths for cutting and assembly by customer. • WalzCraft can also cut to length and assemble the moldings for you, in which case additional charges will apply. • All radii are measured 3/8" [9.5mm] in from the face of molding.
10	Tambour Molding	#2679: Due to its height, the minimum inside radius this molding can follow is 6" [152.4mm]. #2927: Due to its height, the minimum inside radius this molding can follow is 2 3/8" [60.3mm].

Wood Species Options (Chapter S)

1	Rustic and Knotty Grades	When ordering rustic or knotty grades, narrow moldings, applied moldings and mullion stock moldings might not have knots.
---	--------------------------	---

Molding Length Ordered	Expected Minimum Usable Material
8' [2438.4mm]	93" [2362.2mm]
9' [2743.2mm]	104" [2641.6mm]
10' [3048.0mm]	116" [2946.4mm]
11' [3352.8mm]	128" [3251.2mm]
12' [3657.6mm]	139" [3530.6mm]
13' [3962.4mm]	151" [3835.4mm]
14' [4267.2mm]	162" [4114.8mm]
15' [4572.0mm]	174" [4419.6mm]
16' [4876.8mm]	186" [4724.4mm]

Molding Notes - END

► For PRICING ► See Section N.12 in our current Wholesale Pricing Catalog.

Beaded, Egg & Dart and Plain Molding

#3149

Embossed Beaded Molding ($\frac{1}{4}''W \times \frac{5}{32}''T$)



OS

* Due to tear out in the manufacturing process, this molding is only available in Maple.

#1356

Embossed Beaded Molding ($\frac{3}{16}''W \times \frac{3}{16}''T$)



OS C

* Only available in random lengths. When ordering, please specify total lineal feet required in "Description" column on order form.

#2381

Embossed Beaded Molding ($\frac{7}{16}''W \times \frac{3}{16}''T$)

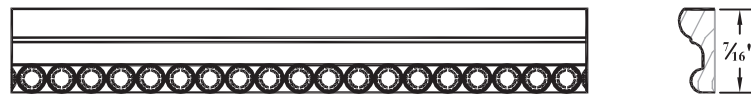

OS

* Only available in random lengths. When ordering, please specify total lineal feet required in "Description" column on order form.

#3162

Embossed Egg & Dart Molding ($1\frac{3}{32}''W \times \frac{7}{32}''T$)

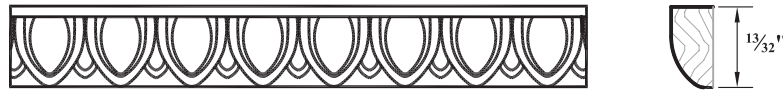

OS

* Only available in random lengths. When ordering, please specify total lineal feet required in "Description" column on order form.

#1999

Plain Accent Molding ($1\frac{3}{32}''W \times \frac{1}{4}''T$)



OS

Half Round Rope Molding (Face and End Views)...continued

#3253

$\frac{3}{8}''$ Diameter Half Round Rope Molding ($\frac{3}{8}''W \times \frac{3}{16}''T$)



OS

#3255

$\frac{1}{2}''$ Diameter Half Round Rope Molding ($\frac{1}{2}''W \times \frac{7}{32}''T$)



OS

OS = Product outsourced from other vendor.

► For PRICING ► See Section **N.13** in our current Wholesale Pricing Catalog.

Quarter Round Rope Molding (Face and End Views)

#3259

1 1/32" x 7/32" Quarter Round Rope Molding

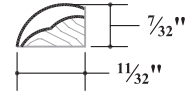

OS

Plate Rail Turned Spindle

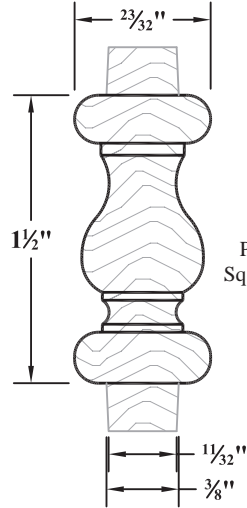

#2388
PC: N/A
Sq Ft: 0.125

OS

Continued on next page...

N

= Available for Convex/Concave products. = Product outsourced from other vendor.

► For PRICING ► See Section [N.13](#) in our current Wholesale Pricing Catalog.

Molding Options

Outsourced Molding

Ordering & Pricing Notes: Outsourced Molding

Ordering Guidelines

1	Order Forms	Please use <i>Molding & Miscellaneous Order Form (E•Z Form #5)</i> .
Pricing		
1	Pricing	Please see <i>Section N.13</i> of our current Wholesale Pricing Catalog .

Technical Notes: Outsourced Molding

Finish Options (Chapter R)

1	Finishing	<p>Moldings will be considered a two-sided (2S) finished product. This includes solid wood refacing stock (<i>Section N.2</i>). The backs will be sealed while the face and all edges will be sealed and top coated.</p> <p>Please see individual drawings for location of clear sealer vs. clear sealer/clear top coat. The thick black lines represent the face/edges (sealer/top coat) while the thinner gray lines represent the back (sealer only).</p> <ul style="list-style-type: none"> • These locations are also applicable to standard SolidTone applications. The thick black lines represent the face/edges (SolidTone® Topcoat and SolidTone® Primer) while the thinner gray lines represent the back (SolidTone® Primer Only). • For SolidTone® Woodgrain applications, the entire surface (face, edges, back) will be comprised of SolidTone® Topcoat only.
---	-----------	---

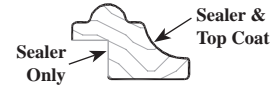

Molding Options (Chapter N)

1	Rope Molding	<p>Molding #3259 is cut from the #3255 Half Round Rope molding.</p> <ul style="list-style-type: none"> • #3259 is a modified cut.
---	--------------	--

Profile Options (Chapter E)

1	Applied Molding Profiles	These moldings may also be applied to some Traditional & Mitered stile and rail profiles with a shelf. See <i>Chapter E</i> .
---	--------------------------	---

Sizes / Dimensions

1	Random Length Molding	<p>When ordering random length molding, please indicate the total lineal feet required in the “Description” column on the <i>Molding & Miscellaneous Order Form (E•Z Form #5)</i>.</p> <p>Moldings #1356, 2381, 3162 are only available in various random lengths. See <i>Section N.13</i> of our current Wholesale Pricing Catalog.</p>
2	Size Tolerance	As an outsourced product, it is beyond WalzCraft’s ability to control the final dimensions of these moldings. Therefore, outsourced molding, and any molding created from an outsourced molding, will have a size tolerance of +/- 1/16" [1.6mm] in width and height.

Outsourced Molding - END

► For PRICING ► See Section [N.13](#) in our current Wholesale Pricing Catalog.