



Chapter V Table of Contents

Section #	Section Name/Contents	Page #
V.1	MDF/3D Laminate (RTF) Doors & Drawer Fronts and 3D Laminate (RTF) Sheet Stock	V.1.2
	◦ Raw MDF Door & Drawer Front Construction and Ordering	V.1.2
	◦ 3D Laminate (RTF) Door & Drawer Front Construction and Ordering	V.1.2
	◦ 3D Laminate (RTF) Product Features	V.1.2
	◦ 3D Laminate (RTF) Cleaning & Care	V.1.2
	◦ MDF 1-Piece Doors & Drawer Fronts	V.1.3
	◦ MDF 1-Piece Door - Quarter Circle	V.1.5
	◦ MDF 1-Piece Doors - Quarter Circle - Frame & Mullions	V.1.5
	◦ MDF 1-Piece Stile/Rail & Center Panel Profile Combinations	V.1.6
	◦ MDF 1-Piece Frame (GRF) Door Profile/Rubber Glass Retainer	V.1.22
	◦ 3D Laminate (RTF) Compatible Outside Edge Profiles	V.1.24
	◦ MDF & 3D Laminate (RTF) RP (Raised Panel) Drawer Front Profiles	V.1.25
	◦ 3D Laminate (RTF) Foil Color Options	V.1.26
	◦ WalzCraft 3D Laminate (RTF) and Approximate Wood Species & Finish Matches	V.1.26
◦ 3D Laminate (RTF) Sheet Stock	V.1.32	
V.2	Decorative Laminate Veneer (DLV)	V.2.1
	◦ Decorative Laminate Veneer (DLV) Doors & Drawer Fronts	V.2.1
	◦ Decorative Laminate Veneer (DLV) Colors / Textures	V.2.1
	◦ Decorative Laminate Veneer (DLV) Stile & Rail Profiles	V.2.2
	◦ Decorative Laminate Veneer (DLV) Accessory Moldings	V.2.5
	◦ Decorative Laminate Veneer (DLV) Sheet Stock	V.2.6
	◦ Decorative Laminate Veneer (DLV) Edgebanding Rolls	V.2.7
V.3	High Pressure Laminate (HPL)	V.3.1
	◦ High Pressure Laminate (HPL) Doors & Drawer Fronts	V.3.1
	◦ High Pressure Laminate (HPL) Stock Colors / Finishes	V.3.1
	◦ High Pressure Laminate (HPL) Door Manufacturing Options	V.3.1
	◦ High Pressure Laminate (HPL) Sheet Stock	V.3.3
V.4	Melamine	V.4.1
	◦ Melamine Doors & Drawer Fronts	V.4.1
	◦ Melamine Sheet Stock	V.4.2
	◦ PVC Edgebanding Rolls	V.4.3

Raw MDF Door & Drawer Front Construction and Ordering

- MDF doors and drawer fronts are constructed of premium, ¾" [19.1mm] or 1" [25.4mm] thick 48# MDF that is precision routed in the door or drawer front style and profiles that you select.
- **To Order MDF Doors or Drawer Fronts...**
 - 1) Select one of the available door styles or drawer front styles.
 - 2) Select one of the available Stile & Rail/Panel Profile combinations starting on *page V.1.6*.
 - 3) Select one of the available Outside Edge Profiles starting on *page V.1.22*.

3D Laminate (RTF) Door & Drawer Front Construction and Ordering

- 3D Laminate (RTF) doors and drawer fronts are constructed of premium ¾" [19.1mm] thick 48# MDF with an Almond or White-W300 True Thermofused Melamine back or a matching 3D Laminate (RTF) back.
 - When choosing a matching 3D Laminate (RTF) back, the product will be approximately 0.040" (1.02mm) thicker than normal.
 - Please note that there is little value in having a 3D Laminate Matching Back in White Crystal, White High Gloss, White Matte, White Wood Grain or Frosty White when we already have a White-W300 Melamine back. Likewise, there is little value in selecting 3D Laminate Matching Back in Almond Crystal, as our Almond Melamine is already a great match.
- Precision routed in the door or drawer front styles and profiles that you select.
- The 3D Laminate (RTF) foil covers the face and edges of the doors and drawer fronts.
- **To Order a 3D Laminate (RTF) Door...**
 - 1) Select one of the available door or drawer front styles.
 - 2) Select one of the available Stile & Rail/Panel Profile combinations starting on *page V.1.6*.
 - 3) Select one of the available Outside Edge Profiles starting on *page V.1.22*.
 - 4) Select one of the available foil colors for the face and edges and also a color for the back (see *page V.1.24*).
 - For the back, specify either Almond Melamine, White-W300 Melamine or matching 3D Laminate (RTF).
 - Note: White High Gloss is only available with a White-W300 Melamine back.
 - For colors with a grain/pattern direction, please specify either horizontal or vertical grain for the doors and drawer fronts.

3D Laminate (RTF) Product Features

- **Construction:** Seamless, one-piece construction with grain pattern running all in the same direction.
- **Dimensional Stability:** Premium MDF core means less expansion and contraction and doors stay flatter than wood doors.
- **Heat Resistance:** Moderate heat resistance. Care should be taken when placed next to a high heat source such as an oven, especially during the self-cleaning cycle. Additional protection from the heat can be achieved with the use of an appliance heat shield between the 3D laminate product and the appliance. Please consult your appliance dealer.
- **Color Consistency:** Color consistency and fade resistance similar to melamine. Better color stability over time than solid wood doors.
- **Environment:** All components meet Carb2 standards for an environmentally friendly product.
- **Bacteria Resistance:** No built-in anti-microbial properties.
- **Easy Care:** Clean with a non-abrasive detergent and a damp sponge or cloth.
- **Scratch Resistance:** 3D Laminates have good scratch resistance.

3D Laminate (RTF) Cleaning and Care

- 3D Laminate (RTF) doors are built to need very little attention.
- We recommend that you use only warm soapy water (*dish soap*) to clean them. Never use anything with abrasive in it.
 - If using stronger cleaning materials, always test a new cleaning solution on a small, less conspicuous area before doing an entire kitchen.
- If 3D Laminate (RTF) doors are installed near a self cleaning oven, dishwasher or any other appliance emitting high heat, in addition to the use of a heat shield, we suggest you open the cabinet doors to avoid heat exposure.

Continued on next page...

► **For PRICING** ► See Section *V.1* in our current Wholesale Pricing Catalog.

MDF 1-Piece Doors & Drawer Fronts

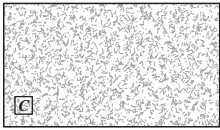

Style: 500*
Drawer Front
Min. Size: 3x3
[76.2mm x 76.2mm]

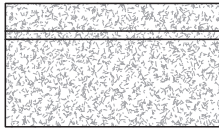

Style: 501*
Drawer Front
Min. Size: 6x6
[152.4mm x 152.4mm]

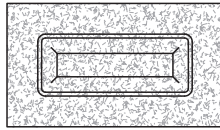

Style: 518*
Drawer Front
Min. Size: 8x8
[203.2mm x 203.2mm]
Shown w/ 2 1/4" wide T/B rails.

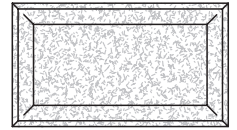

Raised Panel (RP)
Drawer Front
Min. Size: 4x4
[101.6mm x 101.6mm]
See Section B.16 for profiles.

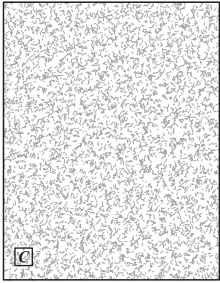

Style: 500
Min. Size: 3x3
[76.2mm x 76.2mm]

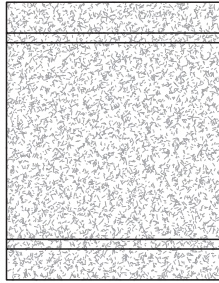

Style: 501
Min. Size: 6x6
[152.4mm x 152.4mm]

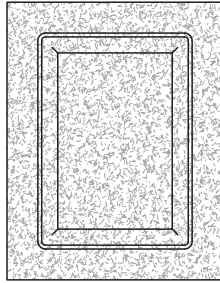

Style: 518
Min. Size: 8x8
[203.2mm x 203.2mm]

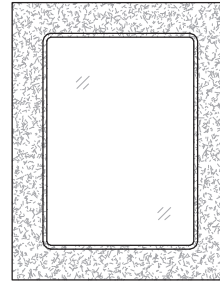

Style: 518-Frame
Min. Size: 8x8
[203.2mm x 203.2mm]

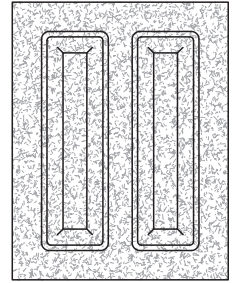

Style: 521
Min. Size: 13 3/4 x 7 1/2
[349.3mm x 190.5mm]

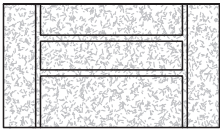

Style: 525*
Drawer Front
Min. Size: 8x6
[203.2mm x 152.4mm]

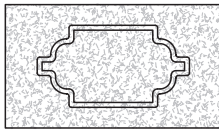

Style: 570*
Drawer Front
Min. Size: 6 7/8 x 6 7/8
[174.6mm x 174.6mm]

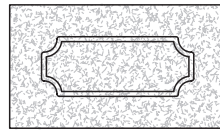

Style: 580*
Drawer Front
Min. Size: 6x6
[152.4mm x 152.4mm]

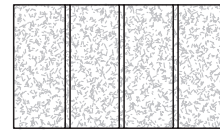

Style: 590*
Drawer Front
Min. Size: 6 x 4 3/8
[152.4mm x 111.1mm]

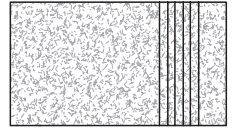

Style: 522*
Drawer Front
Min. Size: 6 3/8 x 4

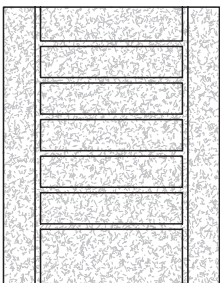
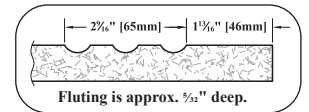

Style: 525
Min. Size: 8x6
[203.2mm x 152.4mm]

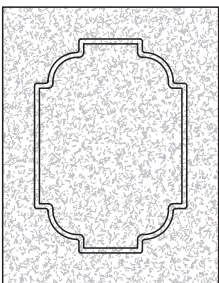

Style: 570
Min. Size: 6 7/8 x 6 7/8
[174.6mm x 174.6mm]

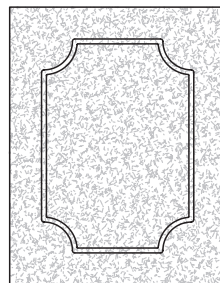

Style: 580
Min. Size: 6x6
[152.4mm x 152.4mm]

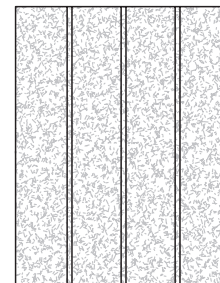

Style: 590
Min. Size: 6 x 4 3/8
[152.4mm x 111.1mm]

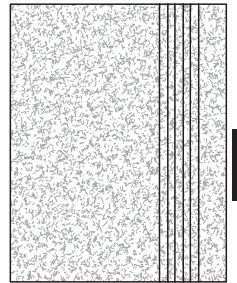

Style: 522
Min. Size: 6 3/8 x 4
[157.2mm x 101.6mm]

Continued on next page...

► For PRICING ► See Section V.1 in our current Wholesale Pricing Catalog.

MDF 1-Piece Doors & Drawer Fronts...continued

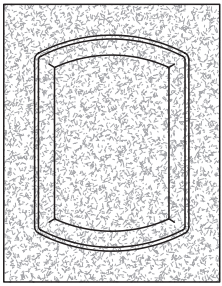

Style: 515
Min. Size: 8x10
[203.2mm x 254mm]

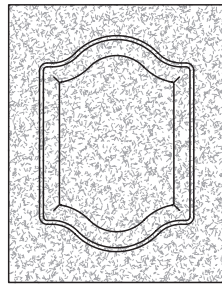

Style: 516
Min. Size: 8x10
[203.2mm x 254mm]

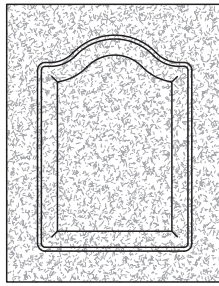

Style: 517
Min. Size: 8x9¼
[203.2mm x 235mm]

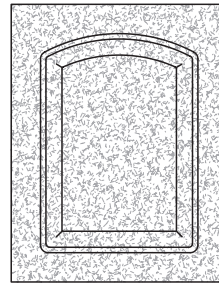

Style: 519
Min. Size: 8x9¼
[203.2mm x 235mm]

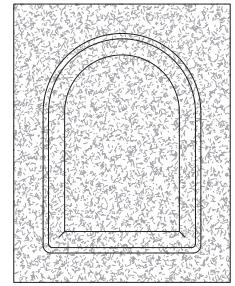

Style: 523
Min. Size: 9x8
[228.6mm x 203.2mm]

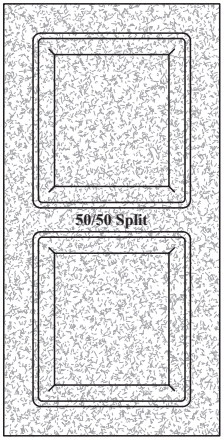

Style: 520
Min. Size: 8x13¼
[203.2mm x 336.6mm]

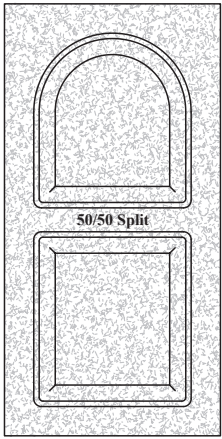

Style: 528
Min. Size: 8x14½
[203.2mm x 368.3mm]

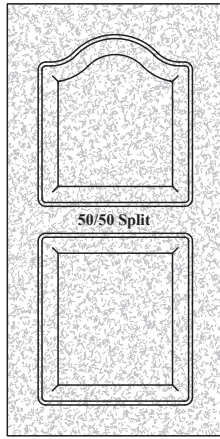

Style: 529
Min. Size: 8x14½
[203.2mm x 368.3mm]

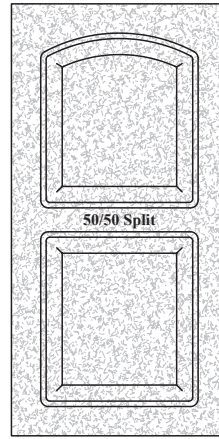

Style: 530
Min. Size: 8x14½
[203.2mm x 368.3mm]

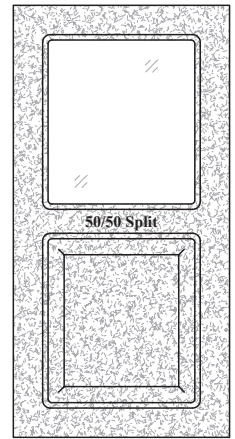

Style: 531
Min. Size: 8x13¼
[203.2mm x 336.6mm]

MDF 1-Piece Doors - Quarter Circle

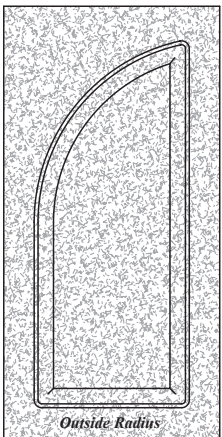

Style: 526L
Min. Size: 8x10¼
[203.2mm x 260.4mm]

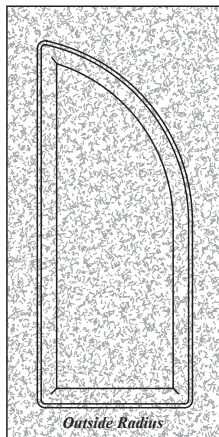

Style: 526R
Min. Size: 8x10¼
[203.2mm x 260.4mm]

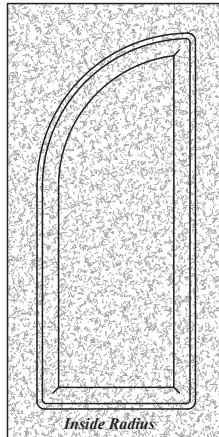

Style: 524L
Min. Size: 8x8
[203.2mm x 203.2mm]

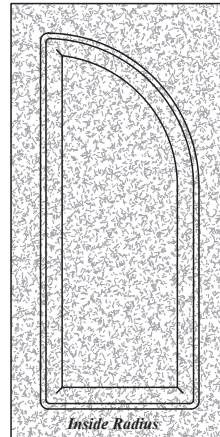

Style: 524R
Min. Size: 8x8
[203.2mm x 203.2mm]

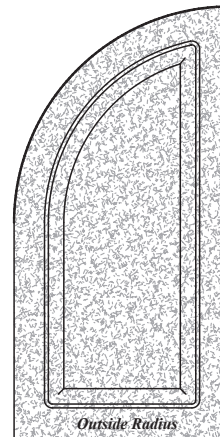

Style: 527L
Min. Size: 8x10¼
[203.2mm x 260.4mm]

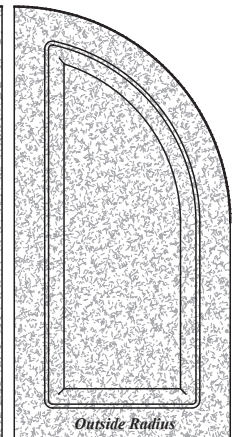

Style: 527R
Min. Size: 8x10¼
[203.2mm x 260.4mm]

Continued on next page...

► **For PRICING** ► See Section *V.1* in our current Wholesale Pricing Catalog.

MDF 1-Piece Doors - Quarter Circle - Frame Only

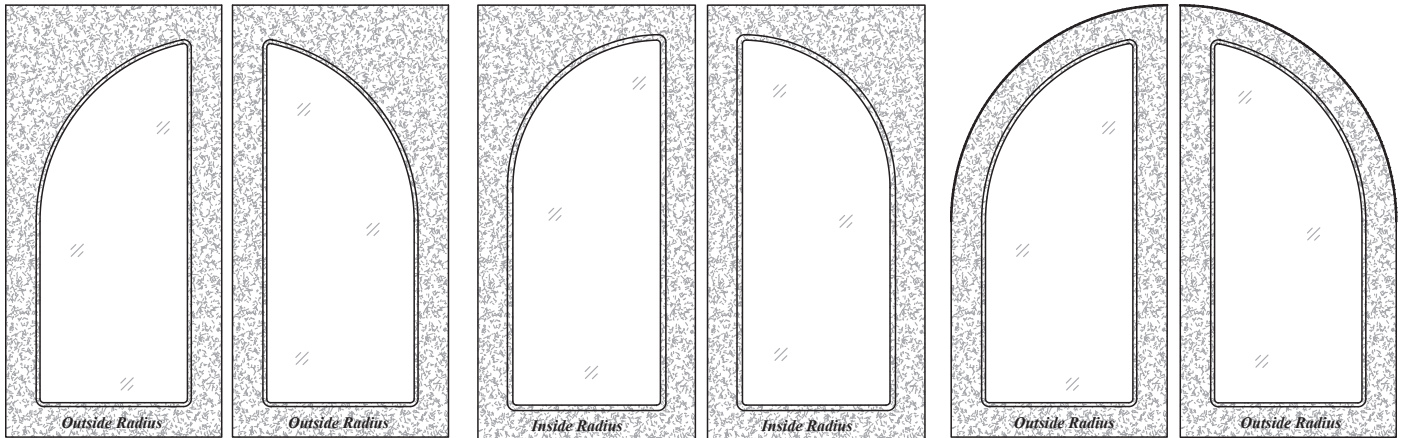

Style: 526L
Frame Only Door
 Min. Size: 8x10¼
 [203.2mm x 260.4mm]

Style: 526R
Frame Only Door
 Min. Size: 8x10¼
 [203.2mm x 260.4mm]

Style: 524L
Frame Only Door
 Min. Size: 8x8
 [203.2mm x 203.2mm]

Style: 524R
Frame Only Door
 Min. Size: 8x8
 [203.2mm x 203.2mm]

Style: 527L
Frame Only Door
 Min. Size: 8x10¼
 [203.2mm x 260.4mm]

Style: 527R
Frame Only Door
 Min. Size: 8x10¼
 [203.2mm x 260.4mm]

MDF 1-Piece Doors - Quarter Circle - Mullions

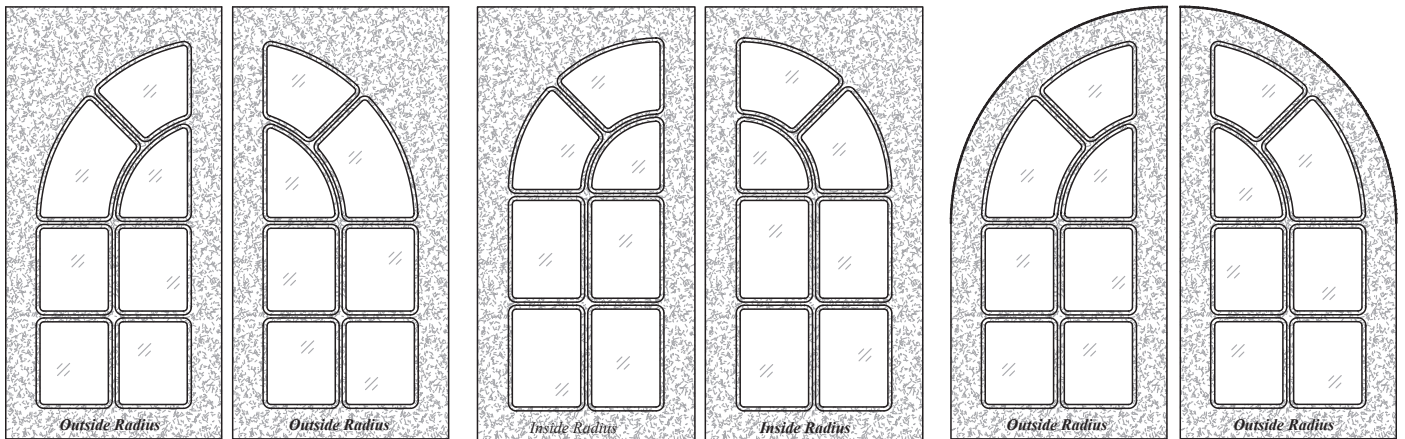

Style: 526L
7 Lite Mullion
 Min. Size: 8x10¼
 [203.2mm x 260.4mm]

Style: 526R
7 Lite Mullion
 Min. Size: 8x10¼
 [203.2mm x 260.4mm]

Style: 524L
7 Lite Mullion
 Min. Size: 8x8
 [203.2mm x 203.2mm]

Style: 524R
7 Lite Mullion
 Min. Size: 8x8
 [203.2mm x 203.2mm]

Style: 527L
7 Lite Mullion
 Min. Size: 8x10¼
 [203.2mm x 260.4mm]

Style: 527R
7 Lite Mullion
 Min. Size: 8x10¼
 [203.2mm x 260.4mm]

Continued on next page...

► For PRICING ► See Section V.1 in our current Wholesale Pricing Catalog.

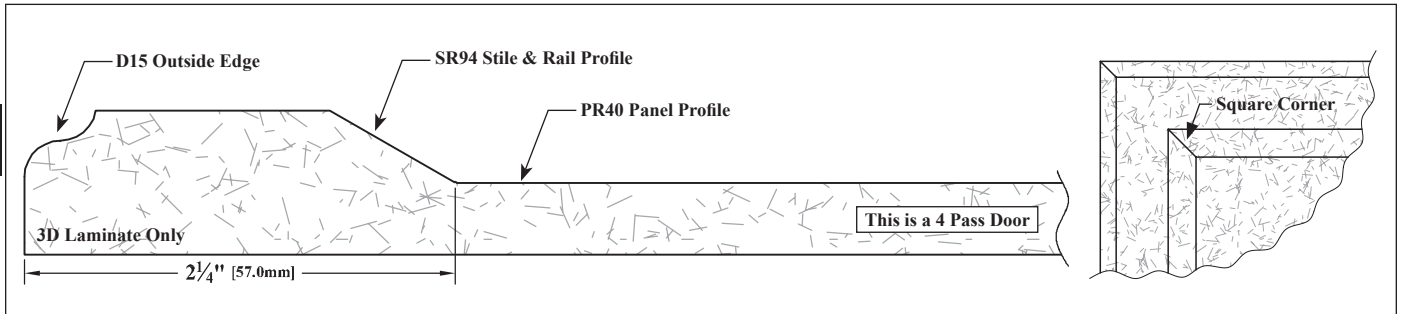
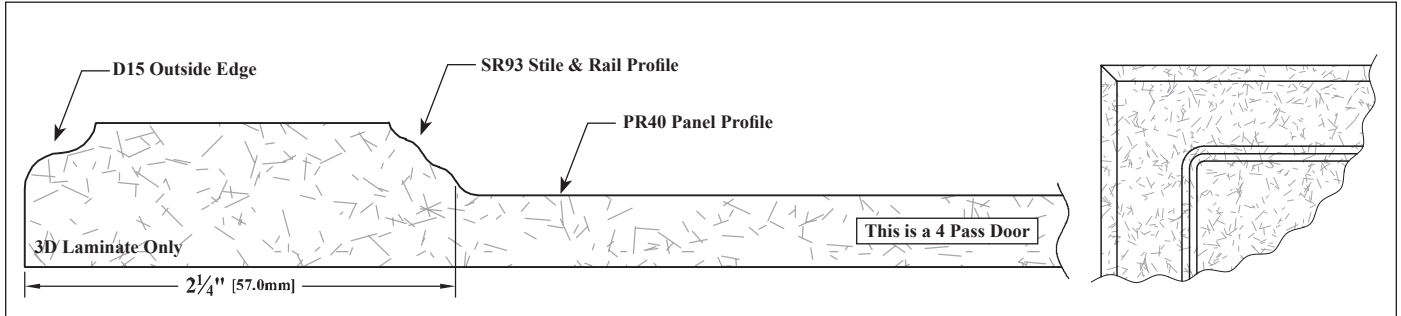
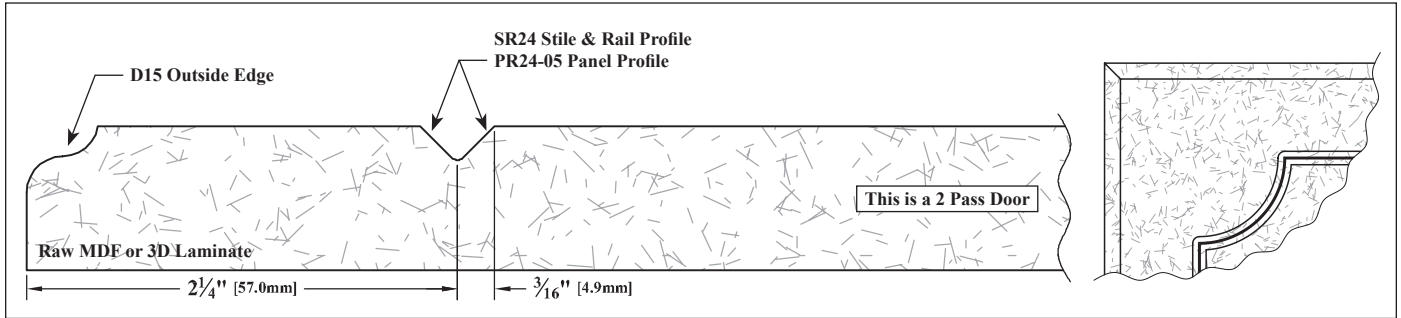
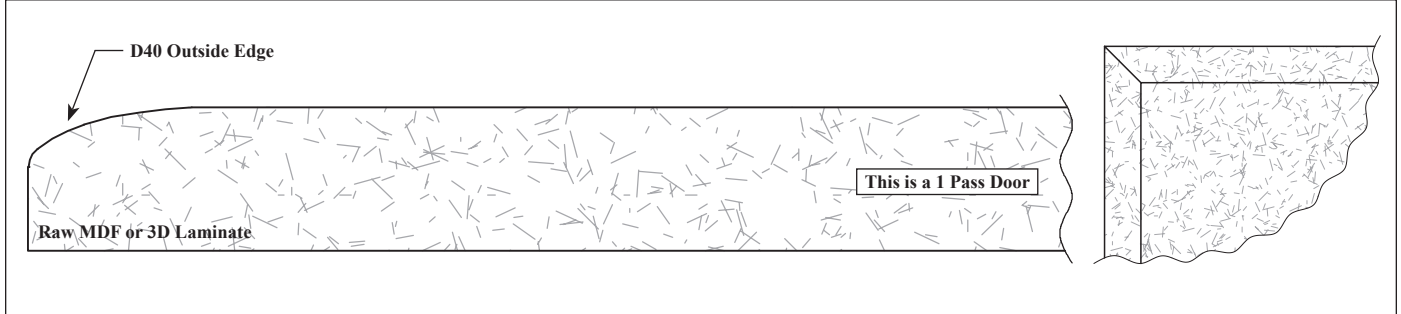
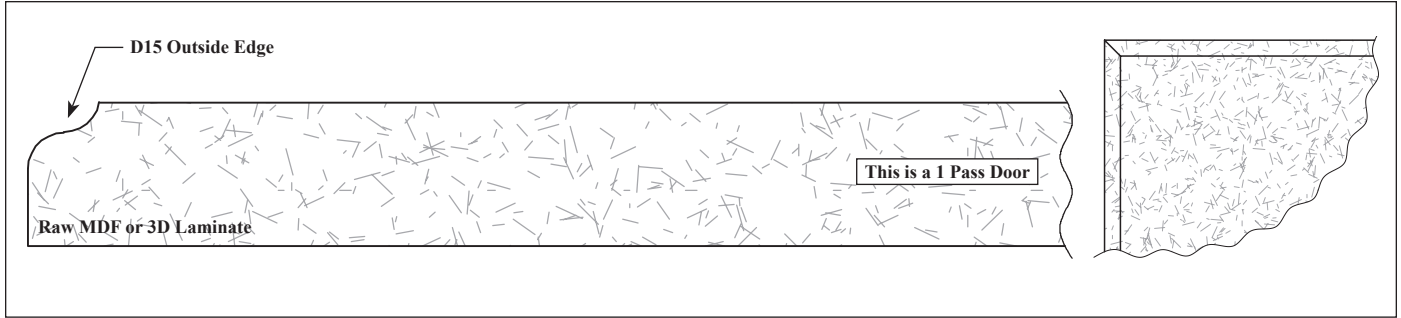

Continued on next page...

► For PRICING ► See Section V.1 in our current Wholesale Pricing Catalog.

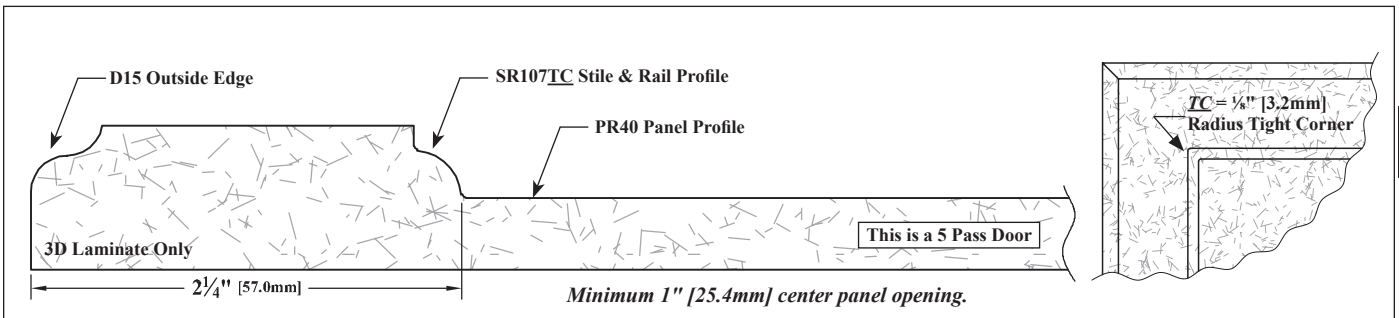
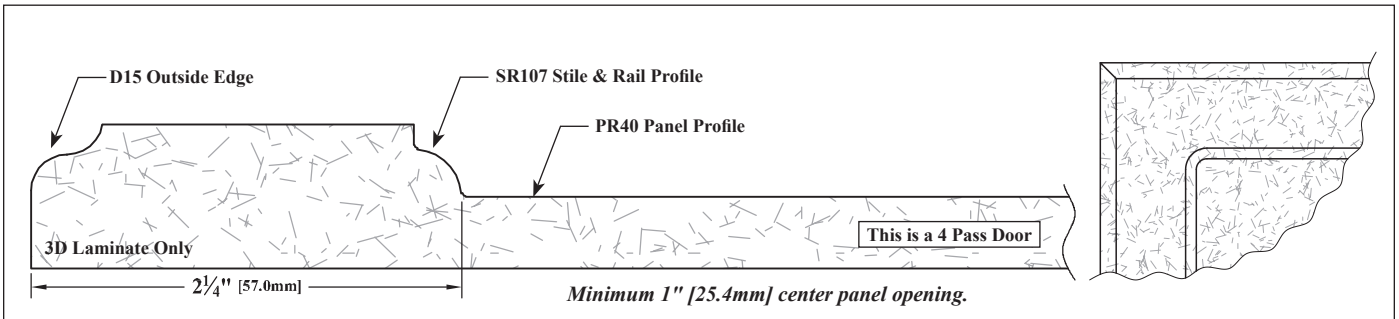
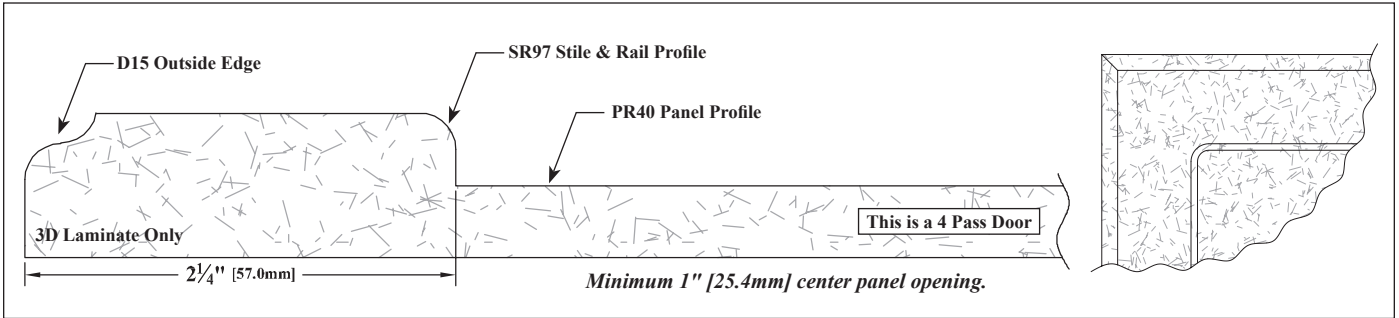
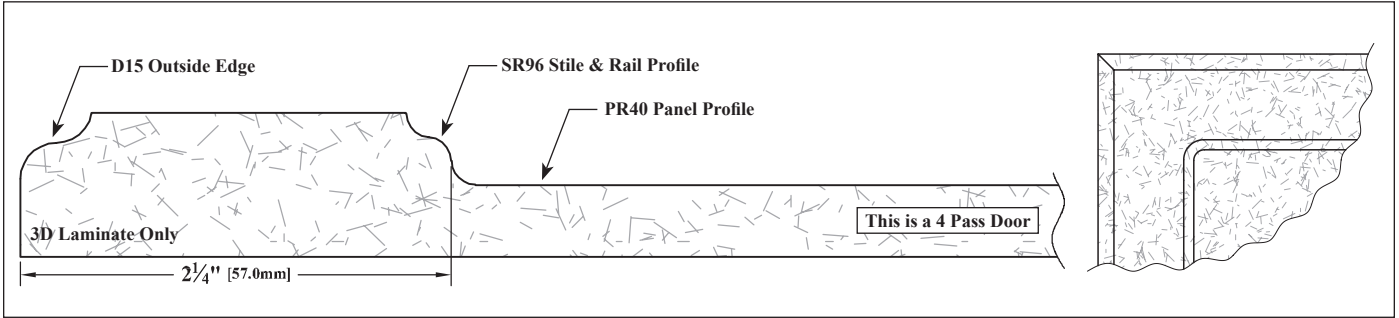
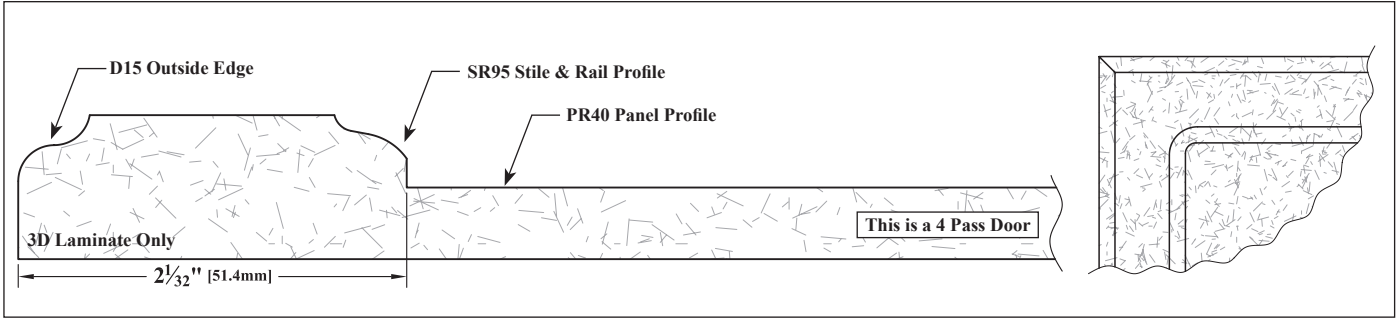

Continued on next page...

► For PRICING ► See Section V.1 in our current Wholesale Pricing Catalog.

Composite Material Options

MDF 1-Piece Doors & DFs/3D Laminate (RTF)

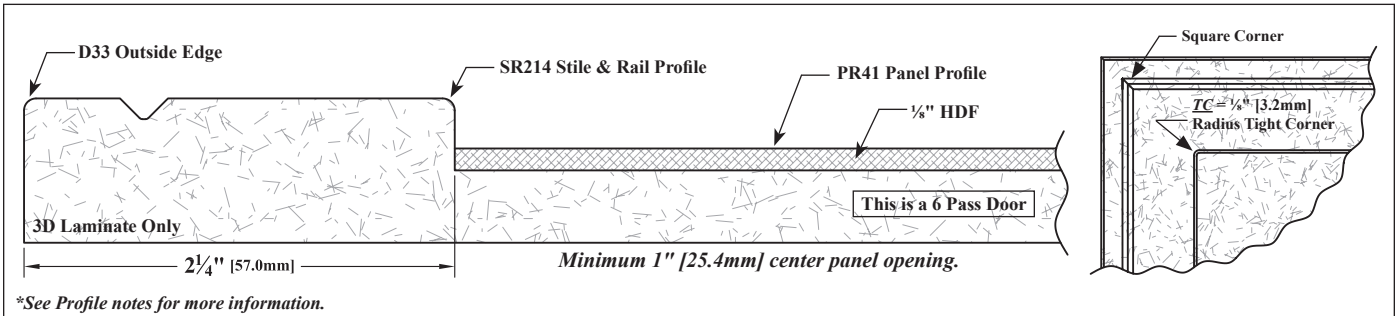
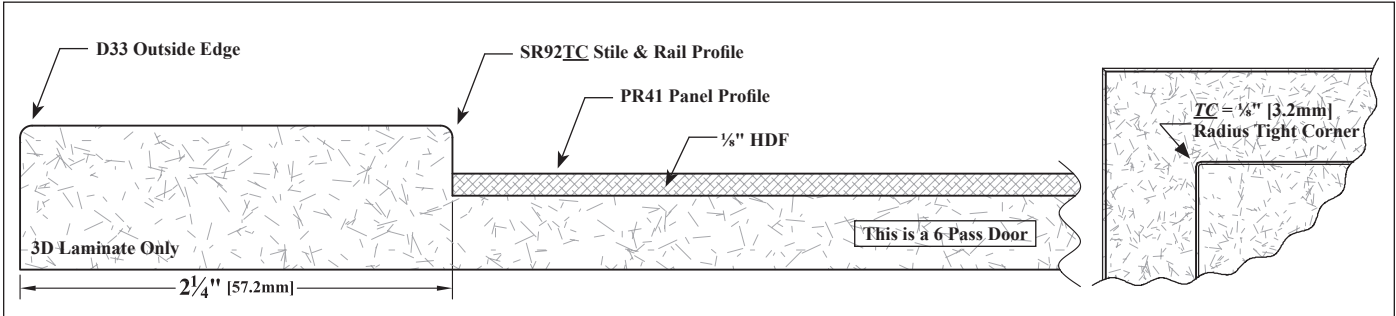
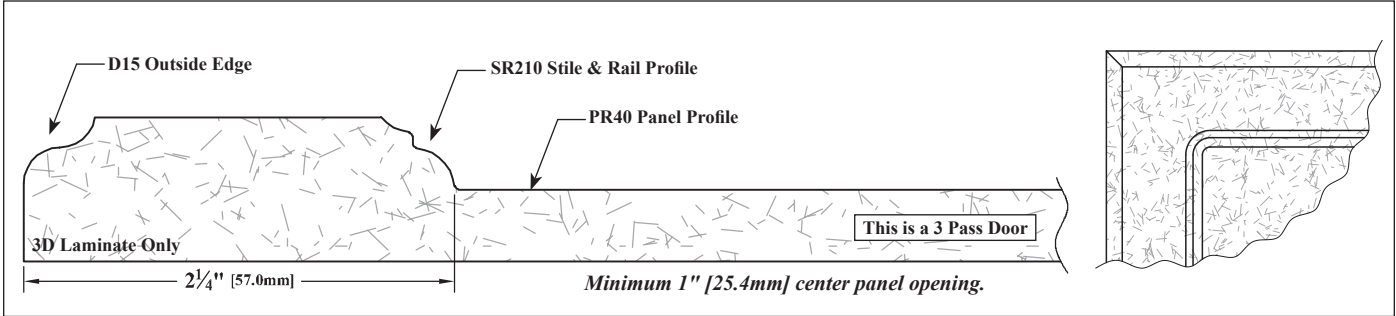
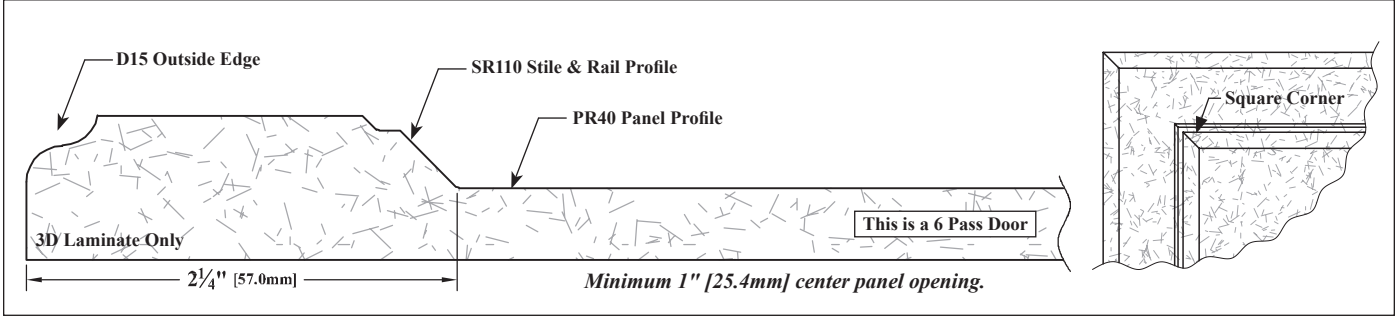
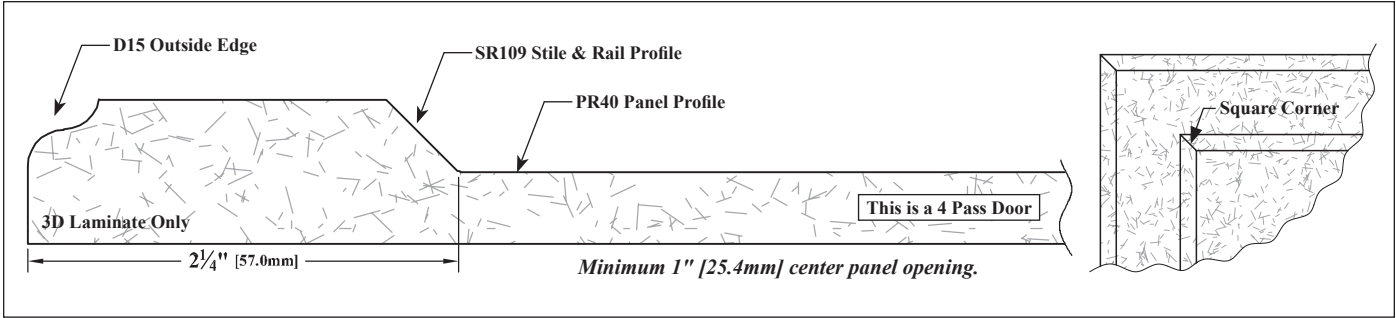

*See Profile notes for more information.

Continued on next page...

► For PRICING ► See Section V.1 in our current Wholesale Pricing Catalog.

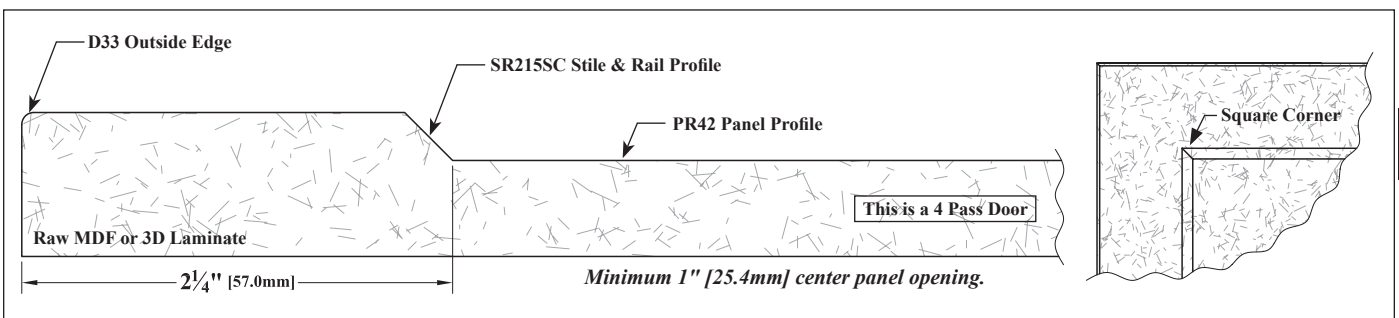
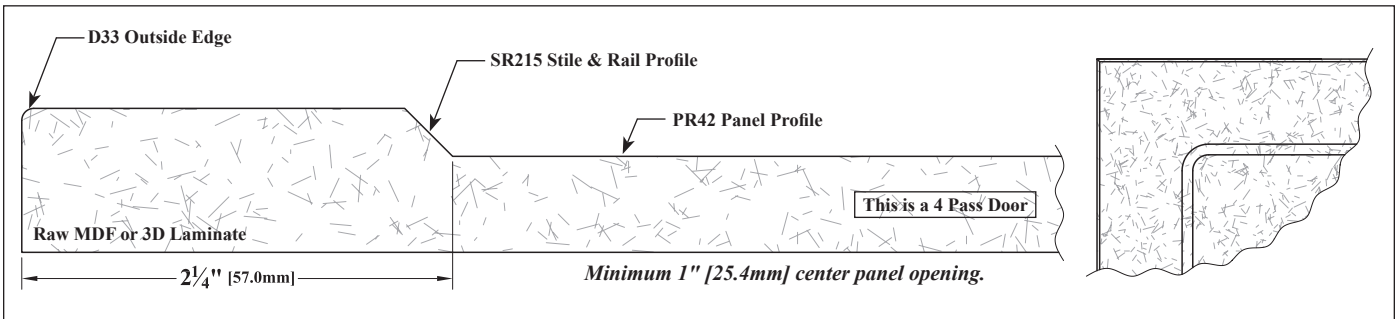
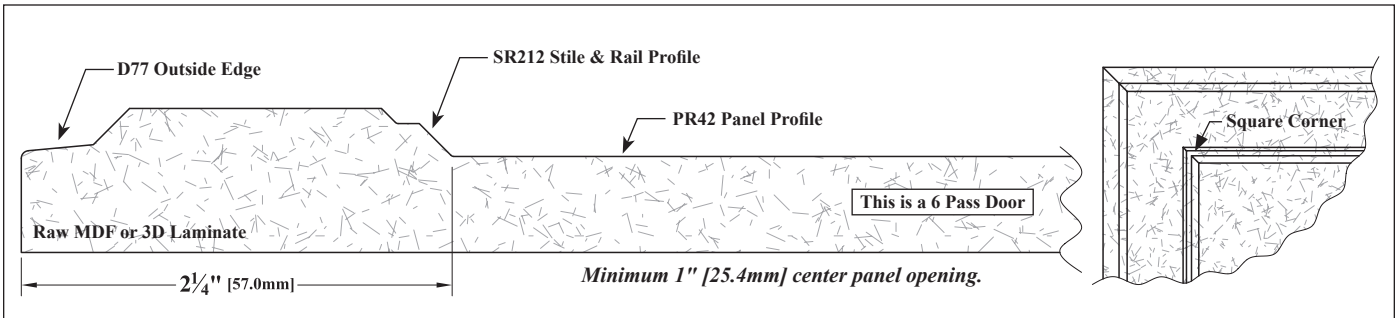
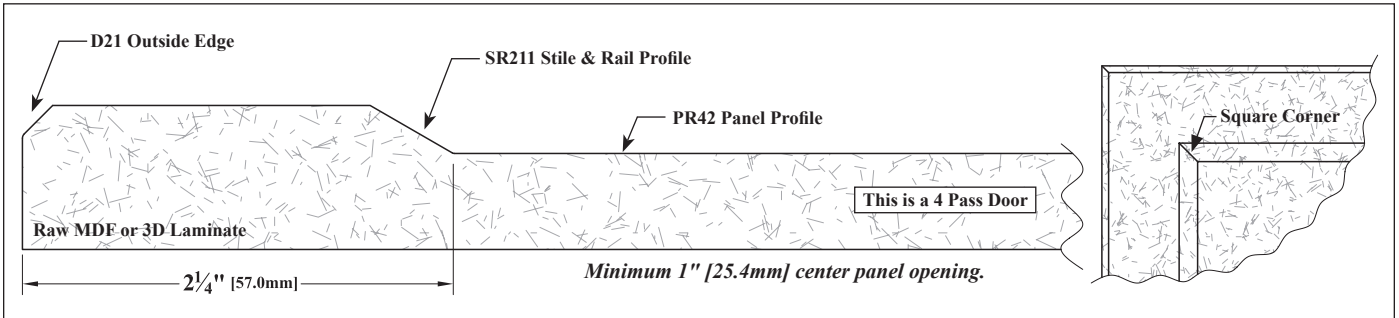
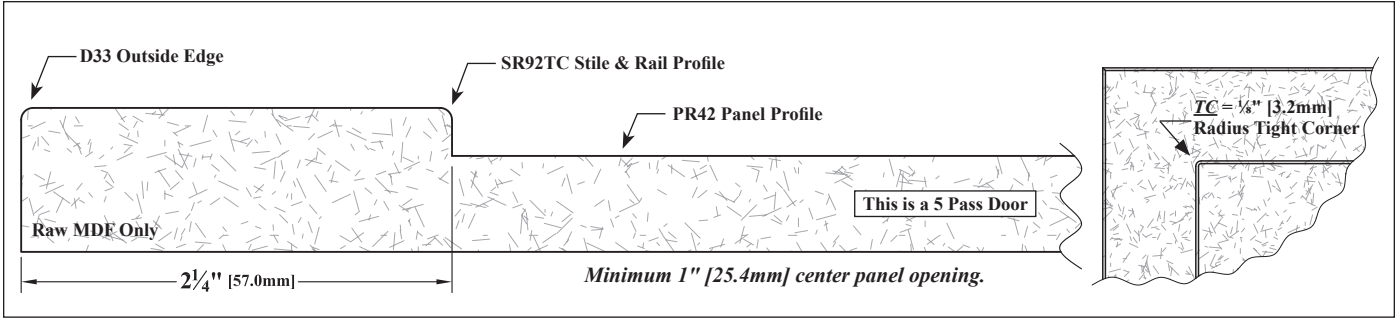

Continued on next page...

► For PRICING ► See Section V.1 in our current Wholesale Pricing Catalog.

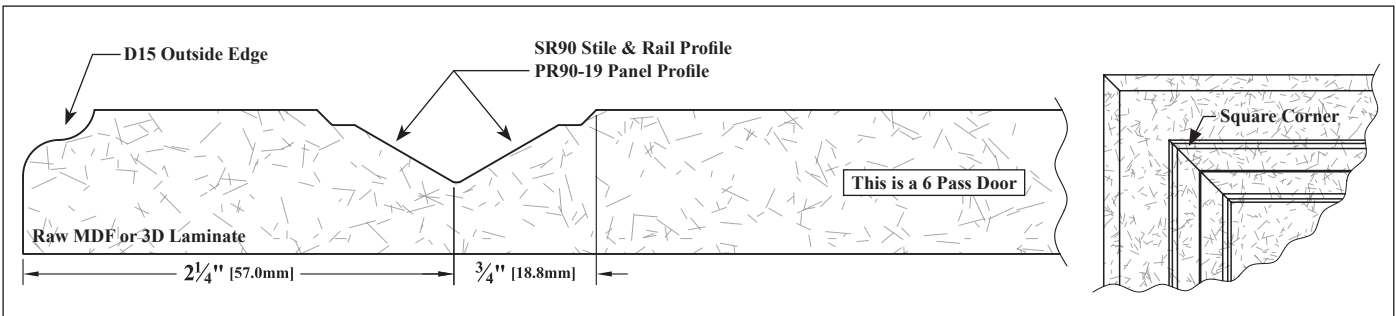
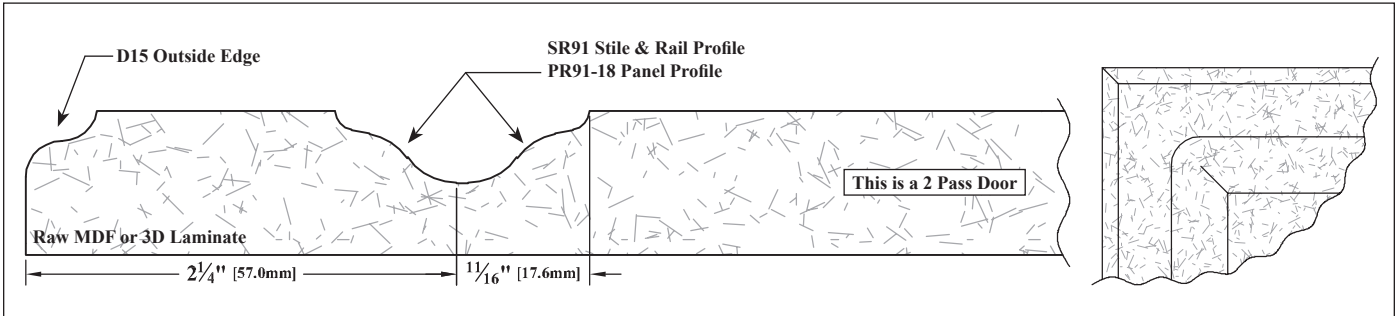
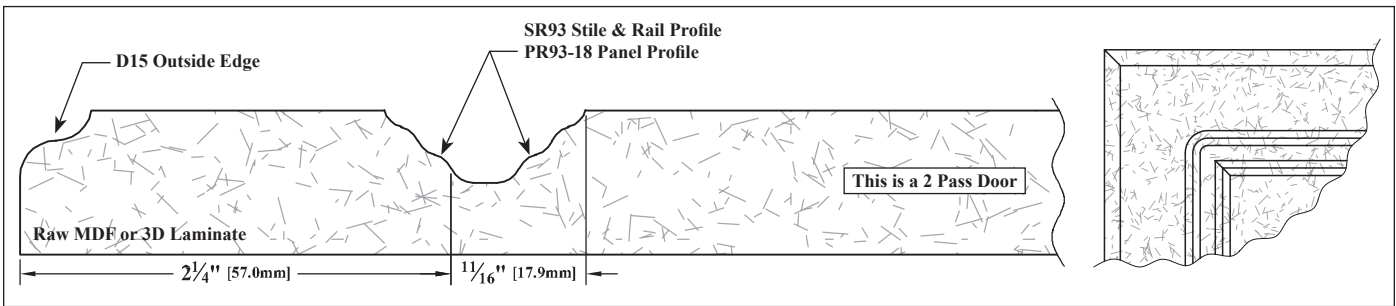
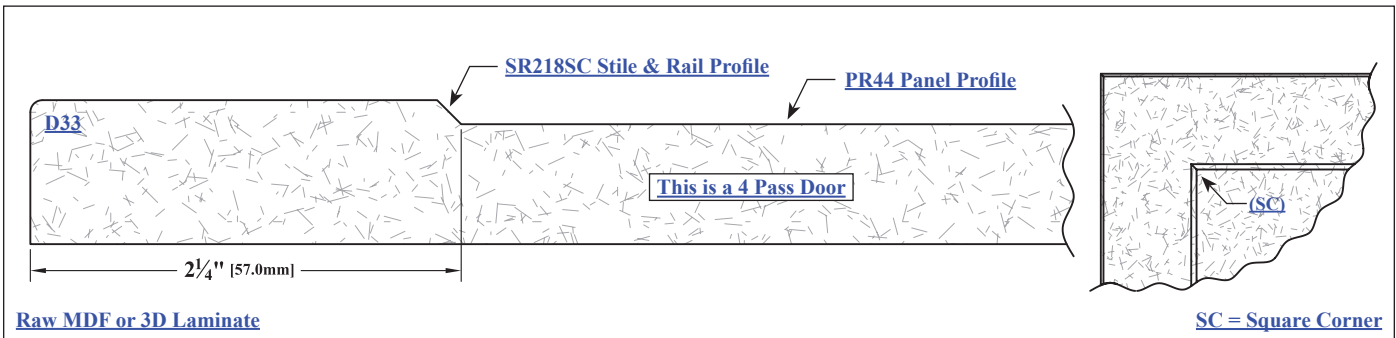
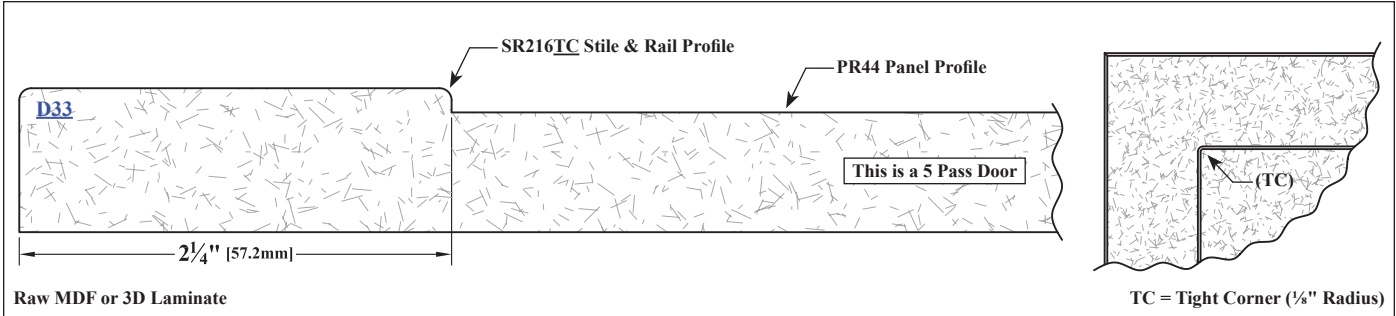

Continued on next page...

► For PRICING ► See Section V.1 in our current Wholesale Pricing Catalog.

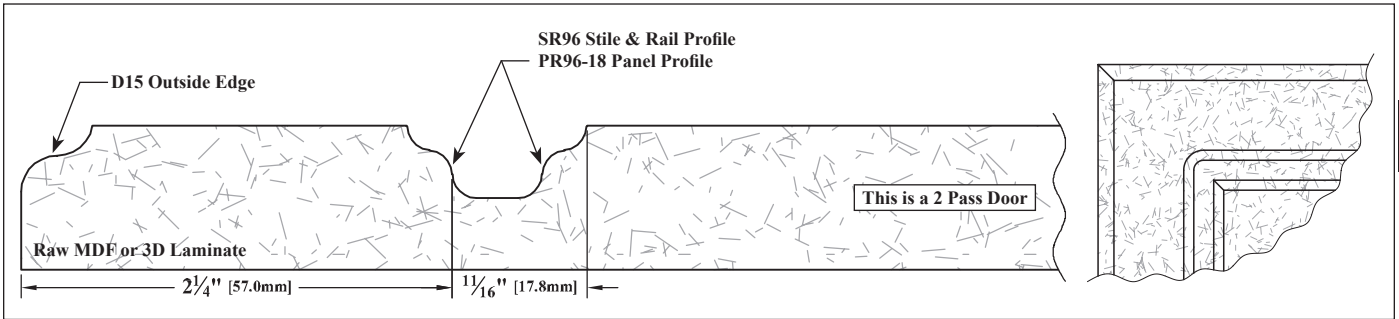
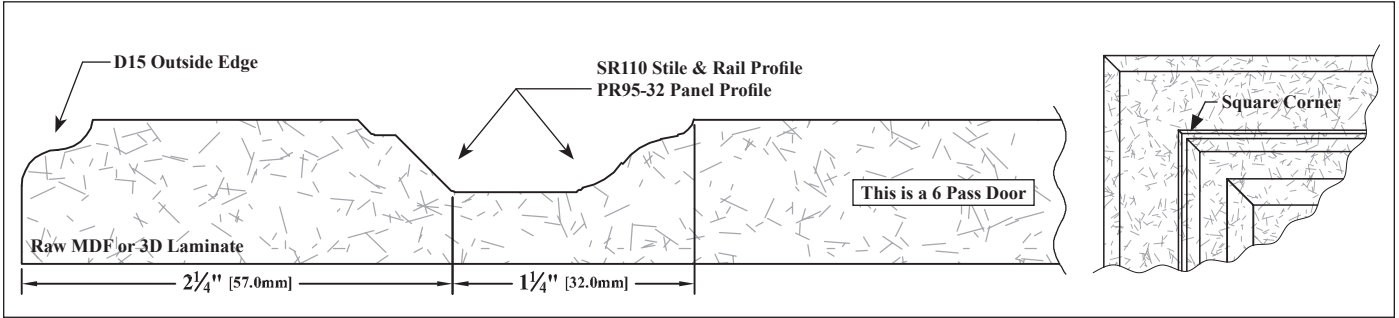
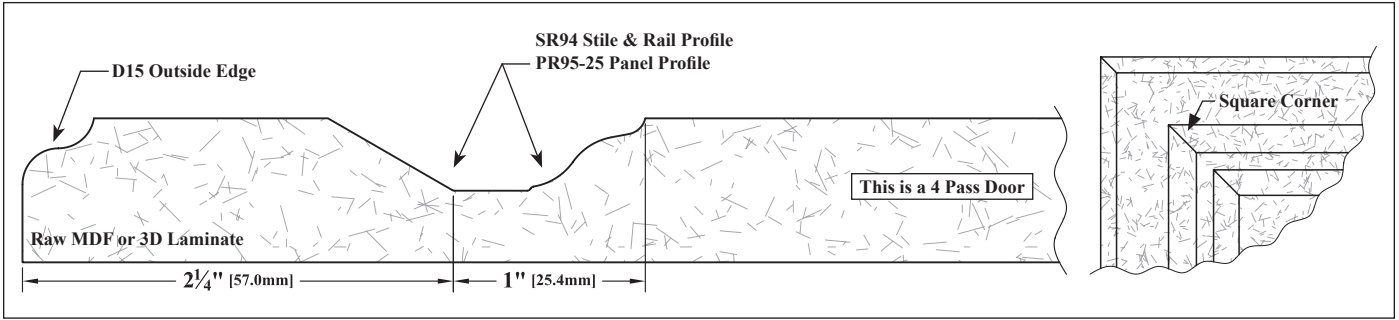
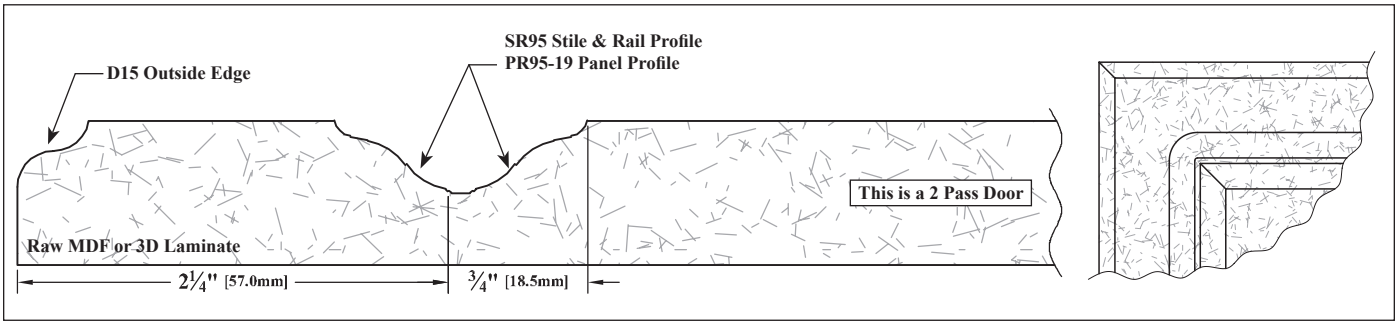
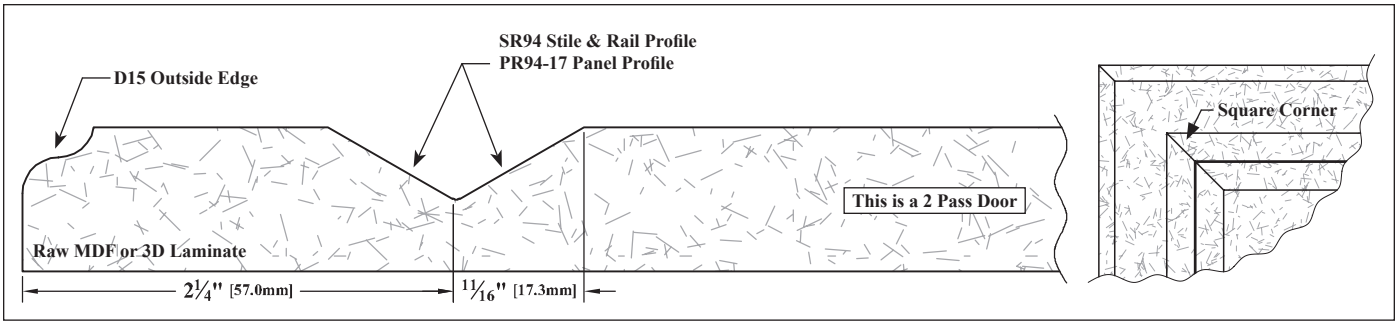

Continued on next page...

► For PRICING ► See Section V.1 in our current Wholesale Pricing Catalog.

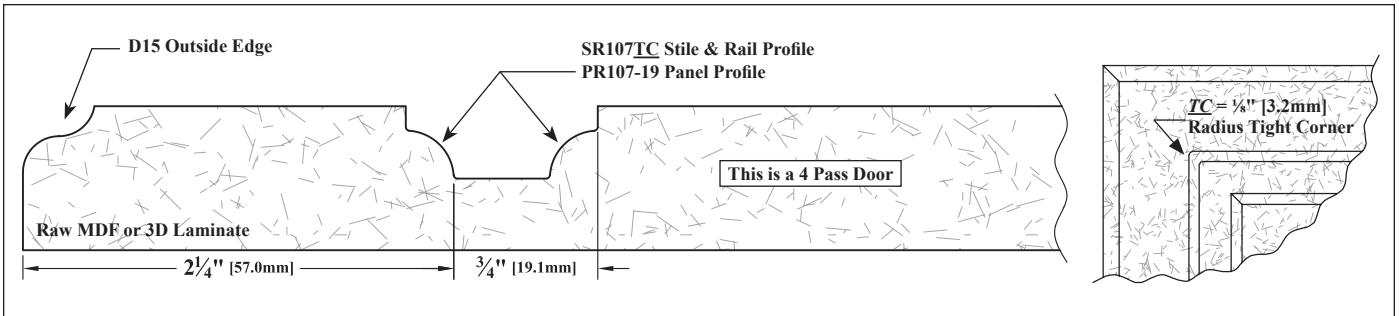
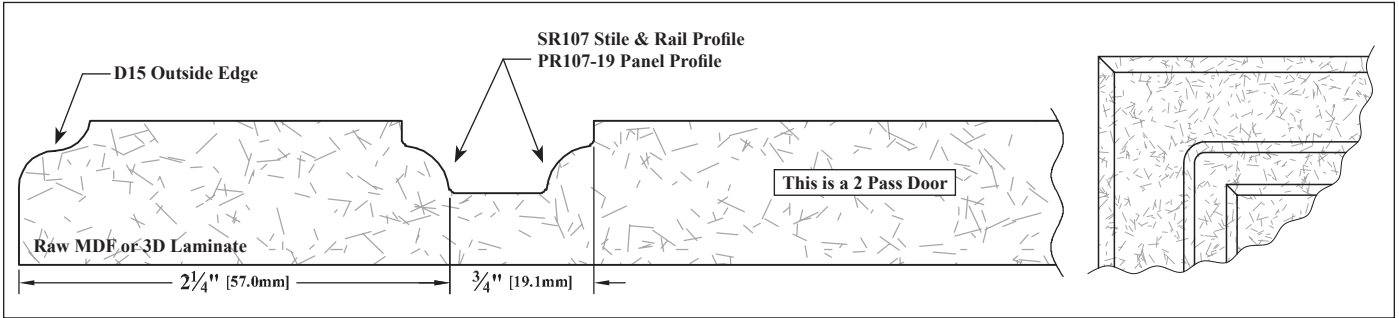
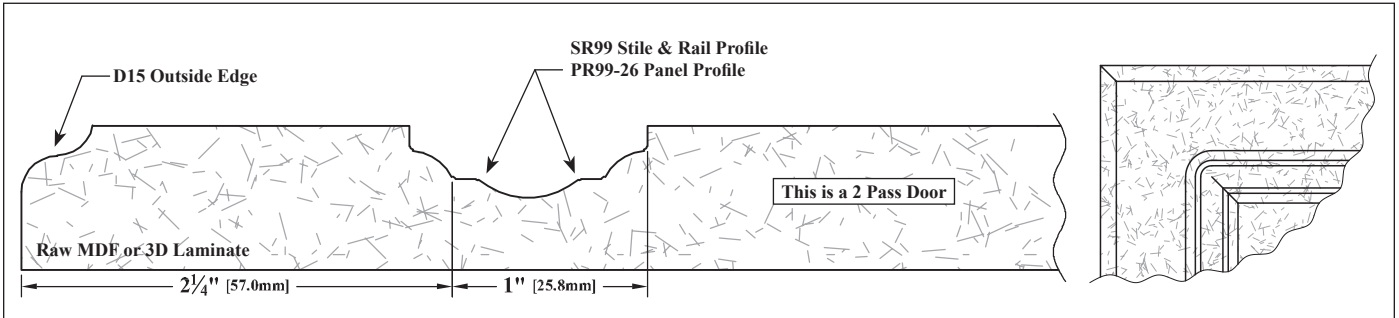
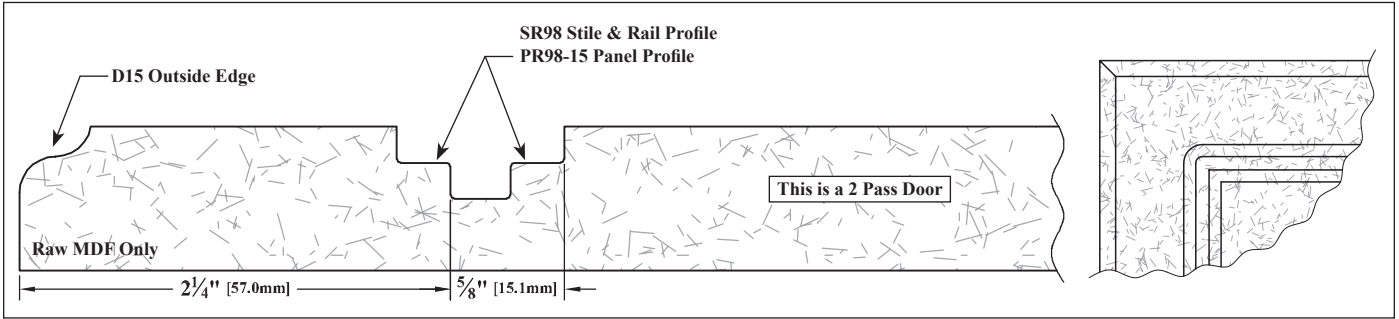
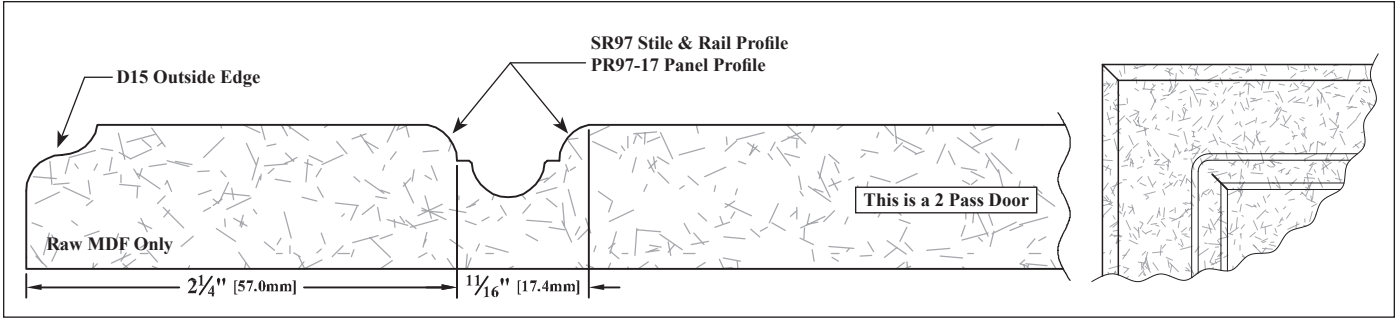

Continued on next page...

► For PRICING ► See Section V.1 in our current Wholesale Pricing Catalog.

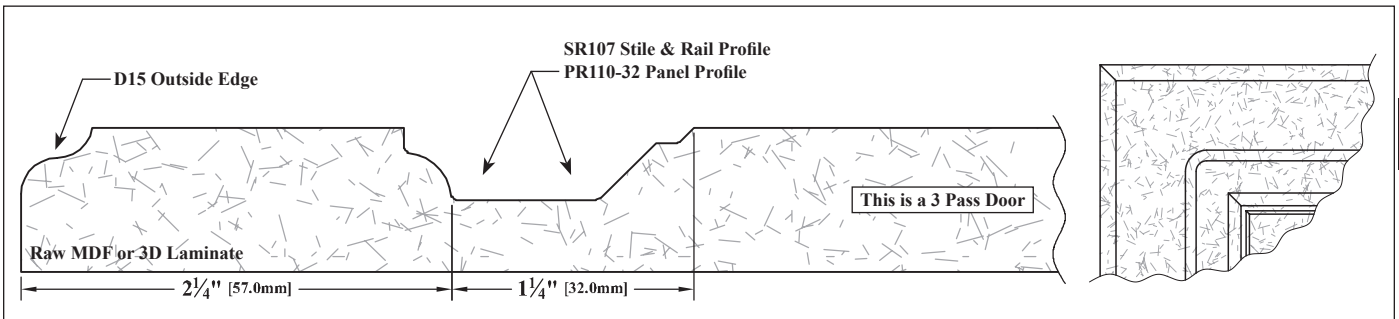
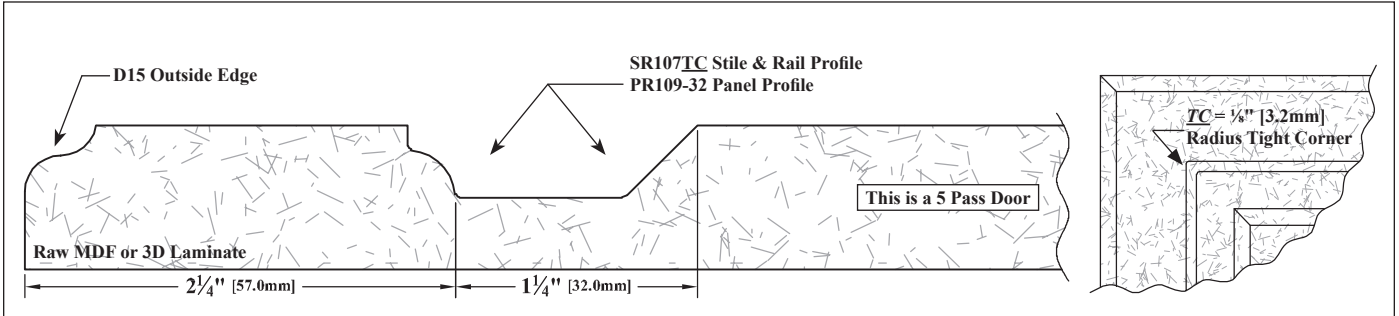
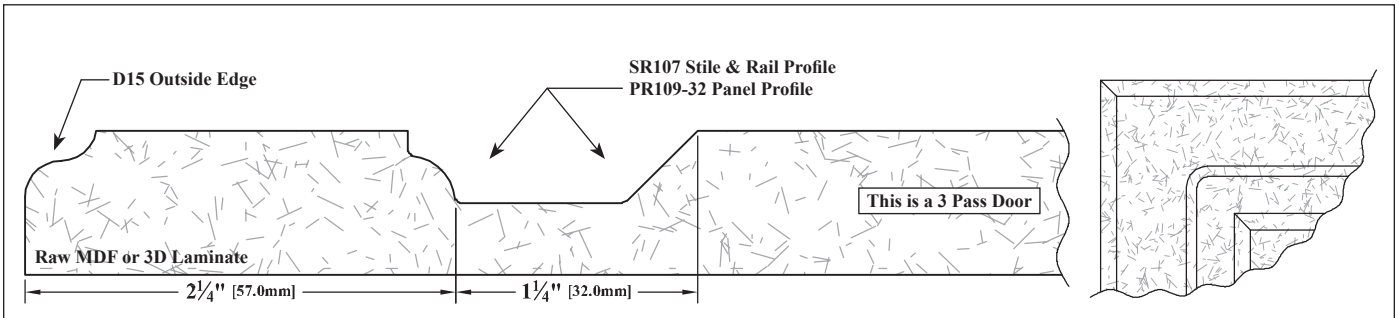
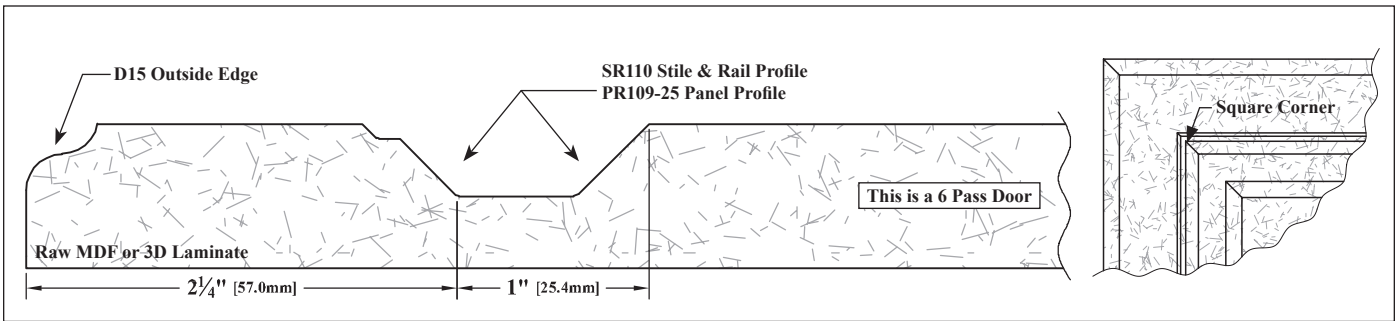
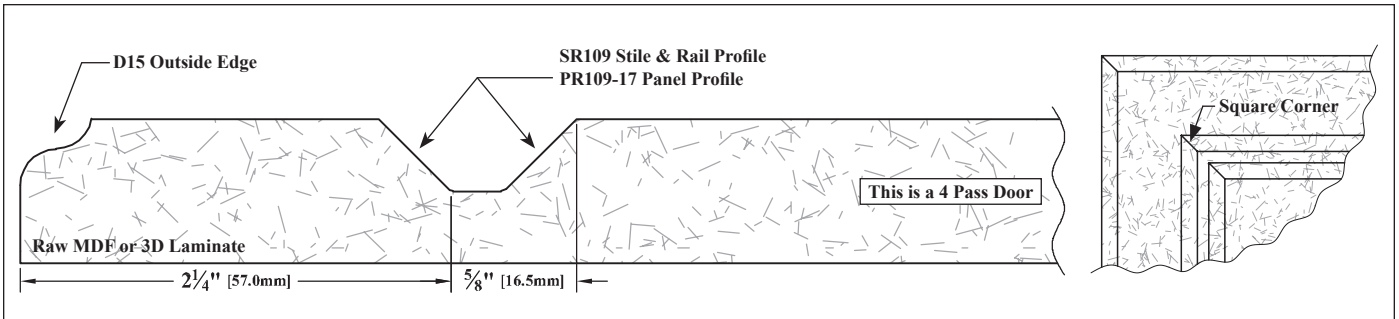

Continued on next page...

► For PRICING ► See Section V.1 in our current Wholesale Pricing Catalog.

Composite Material Options

MDF 1-Piece Doors & DFs/3D Laminate (RTF)

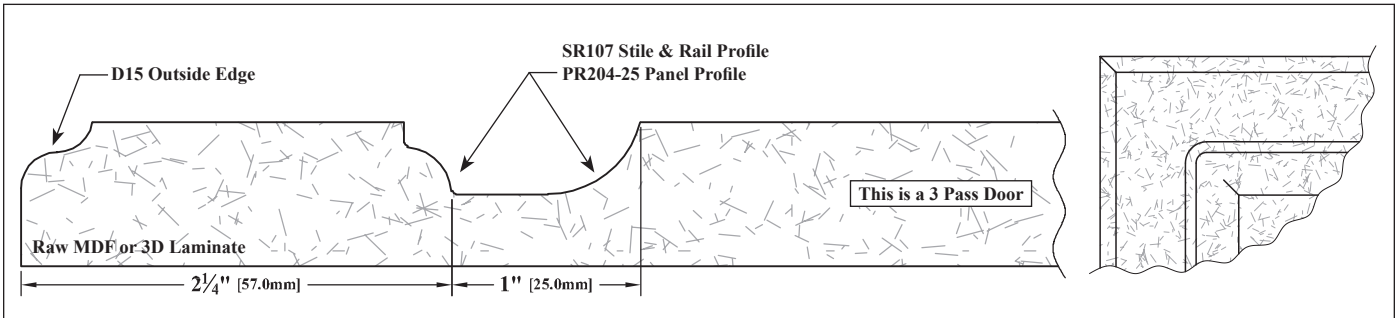
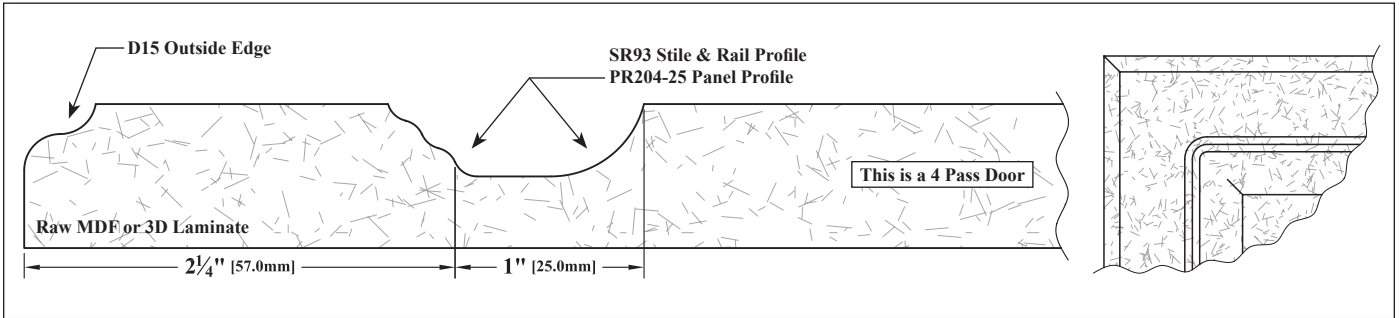
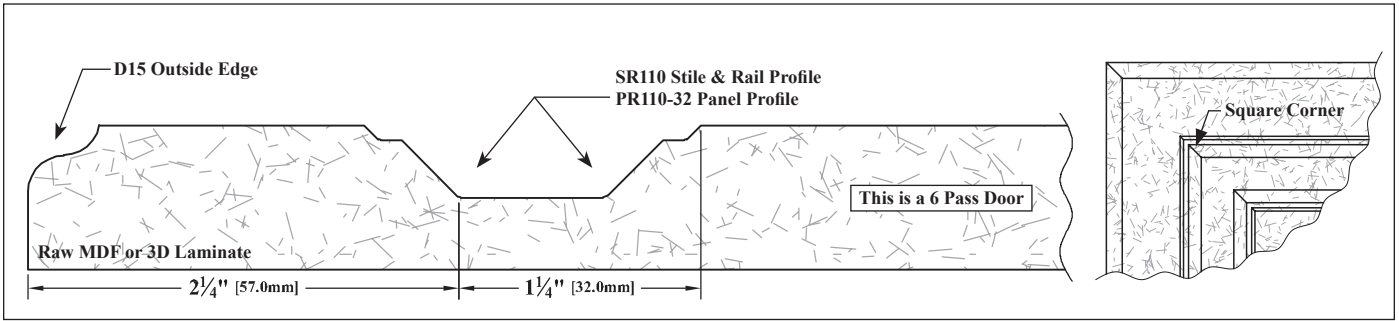
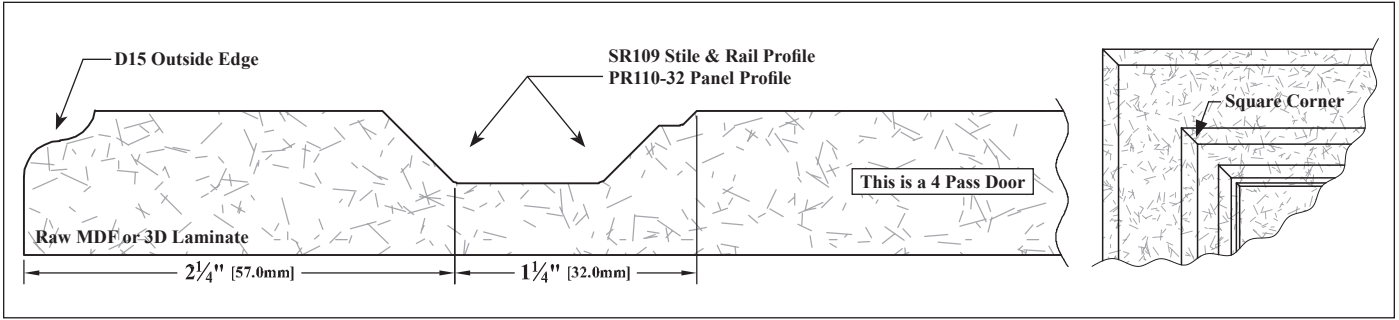
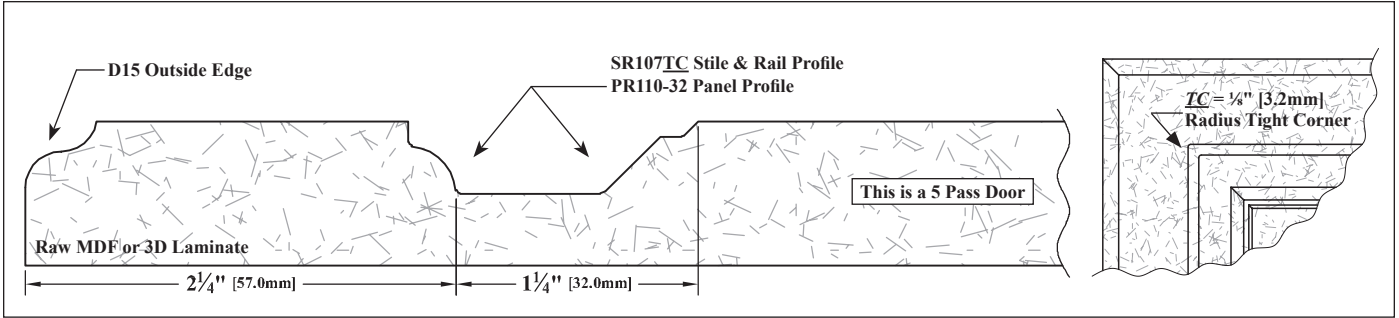

Continued on next page...

► For PRICING ► See Section V.1 in our current Wholesale Pricing Catalog.

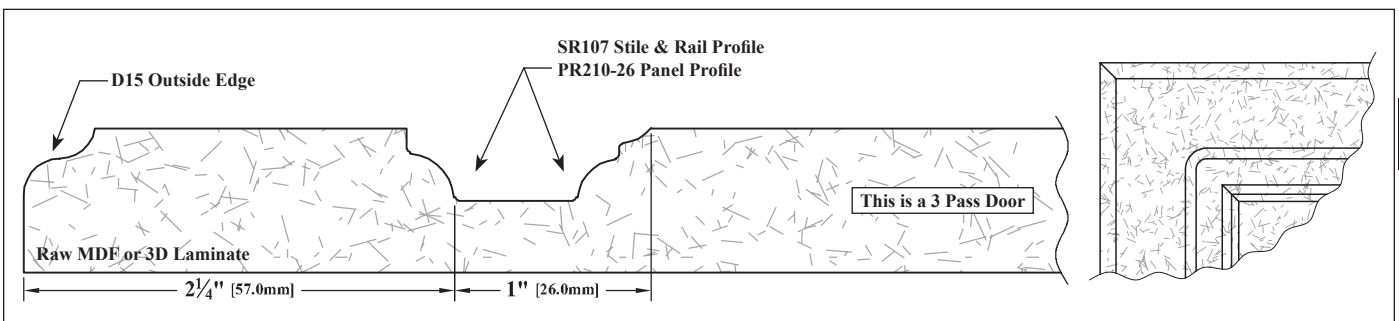
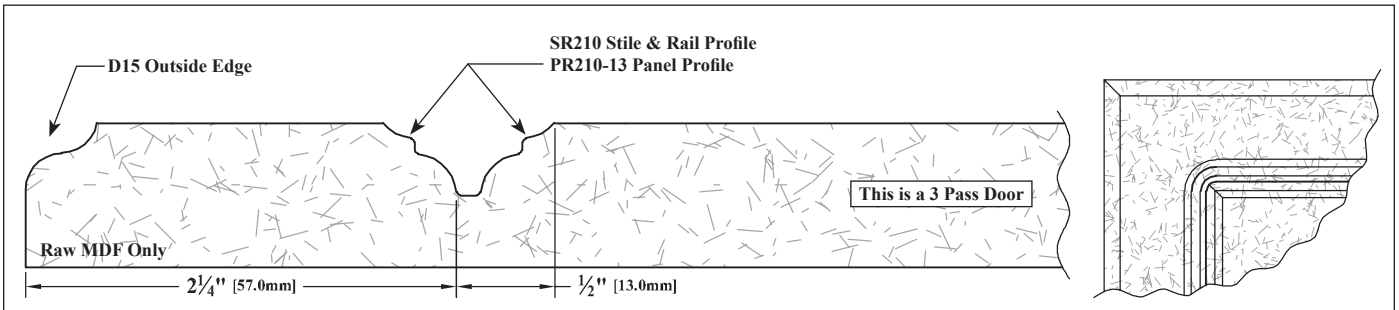
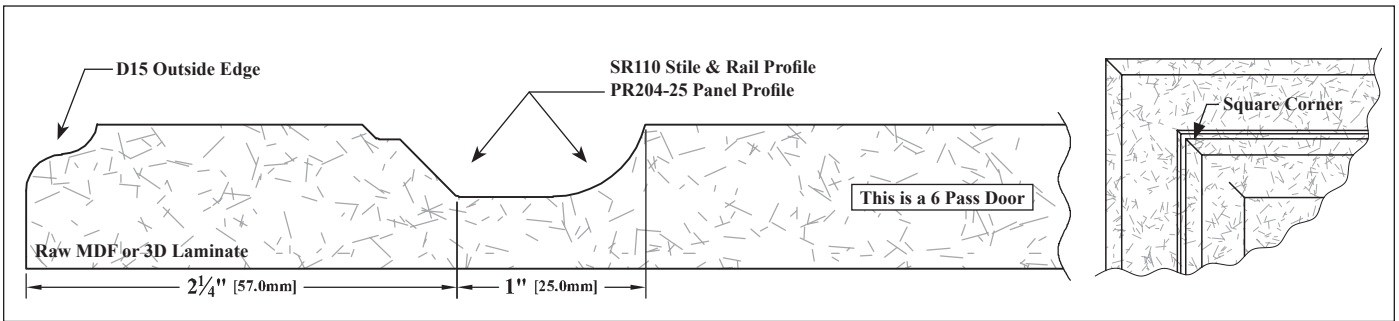
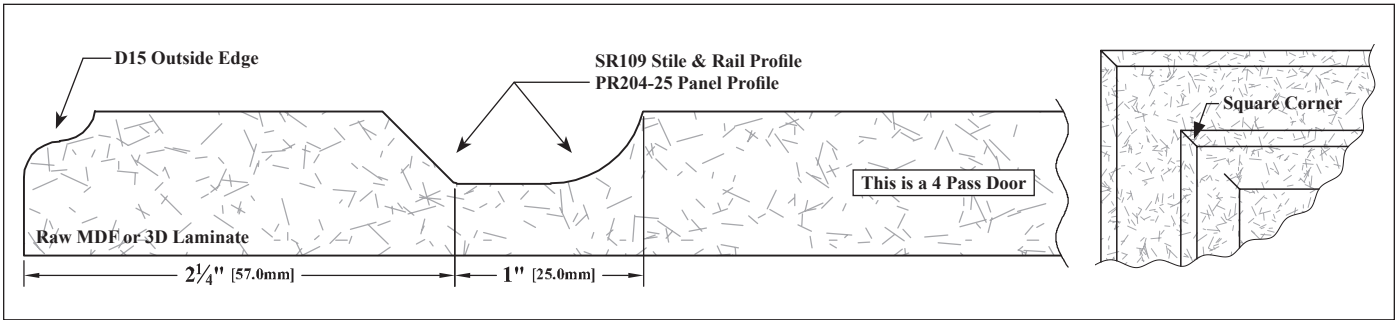
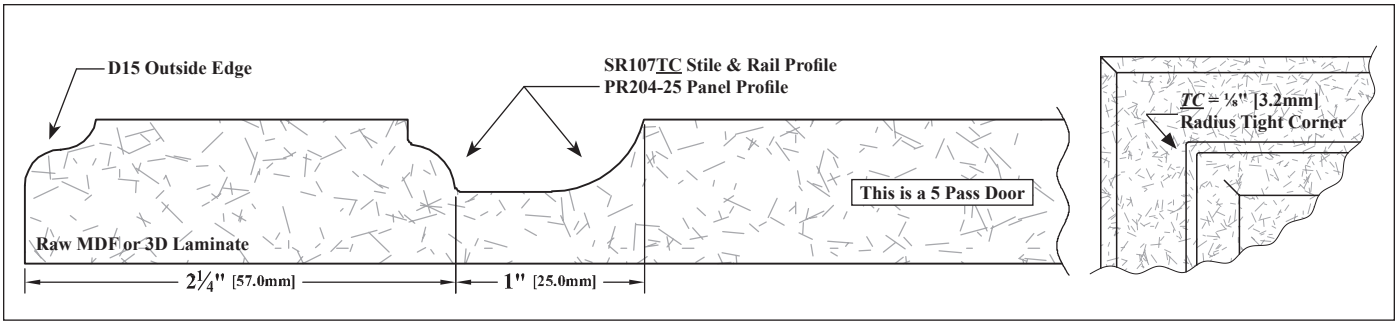

Continued on next page...

► For PRICING ► See Section V.1 in our current Wholesale Pricing Catalog.

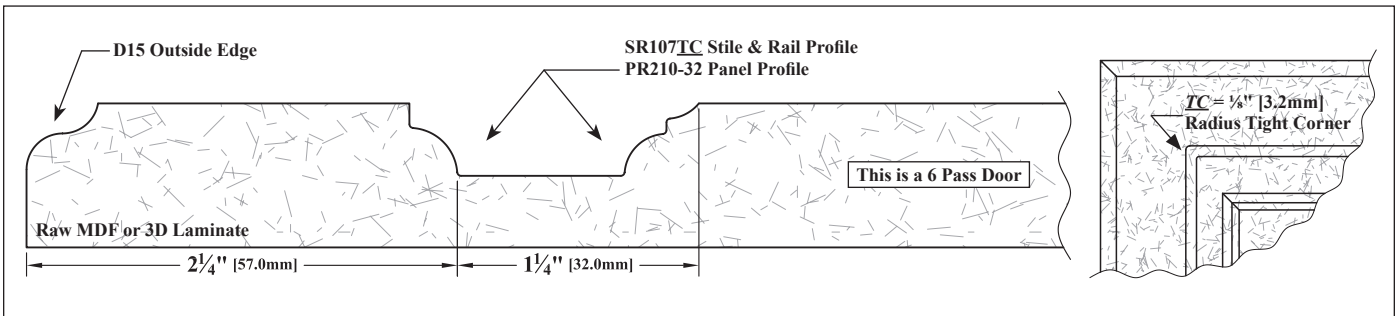
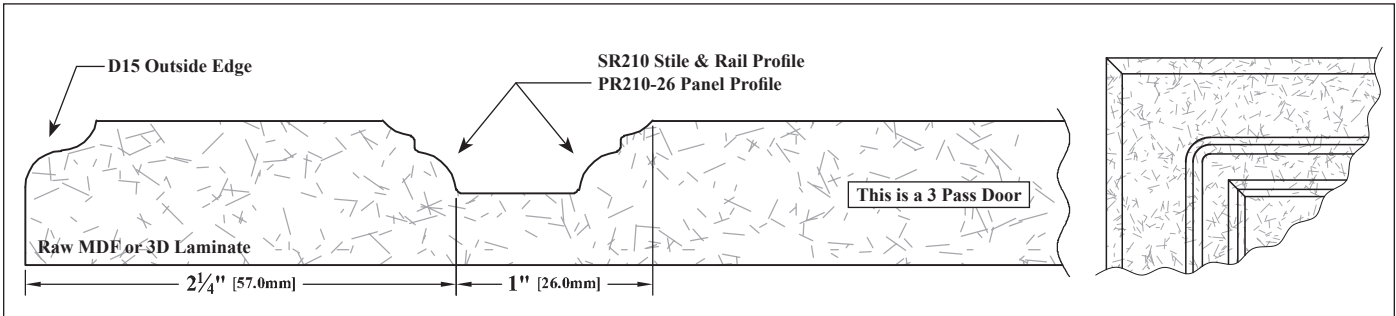
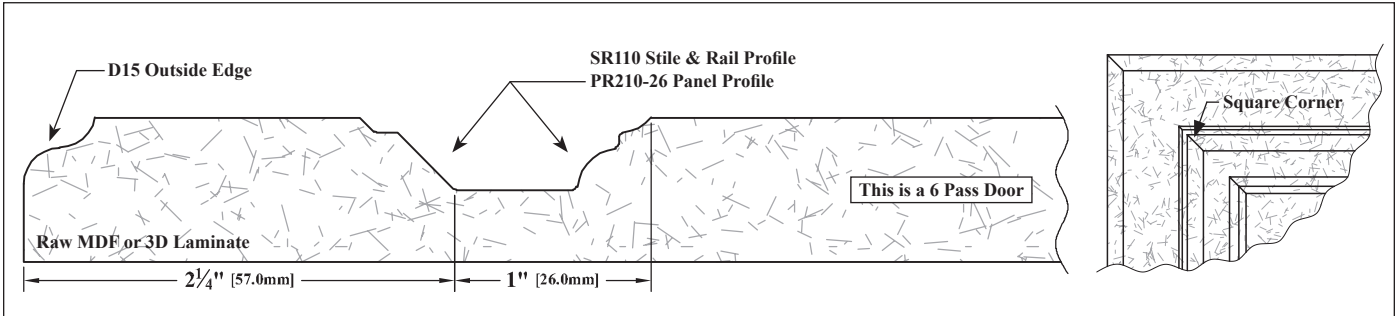
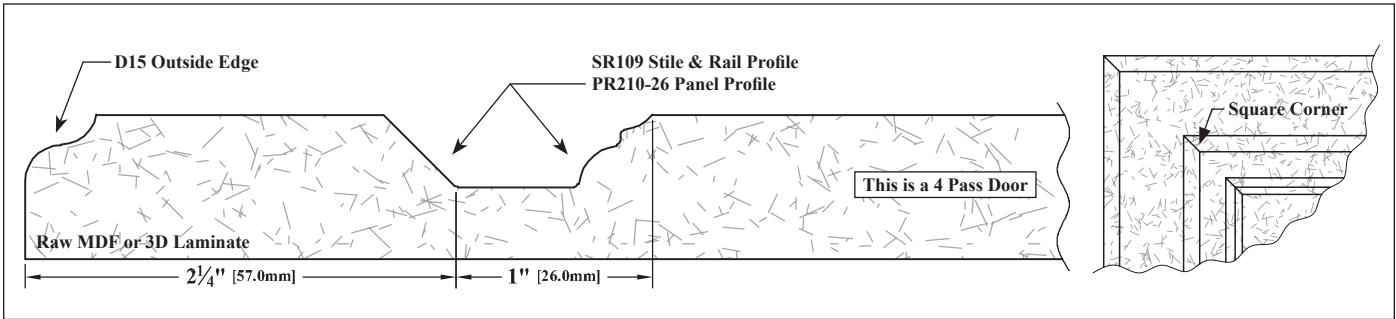
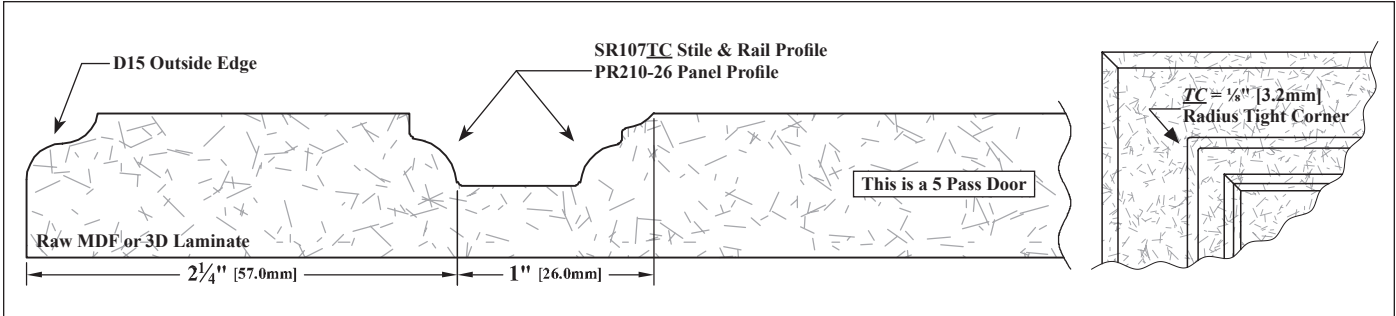

Continued on next page...

► For PRICING ► See Section V.1 in our current Wholesale Pricing Catalog.

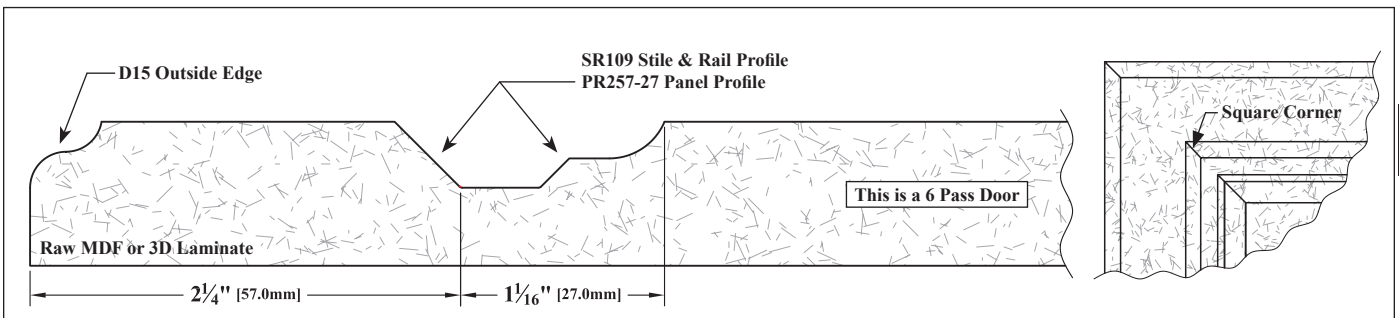
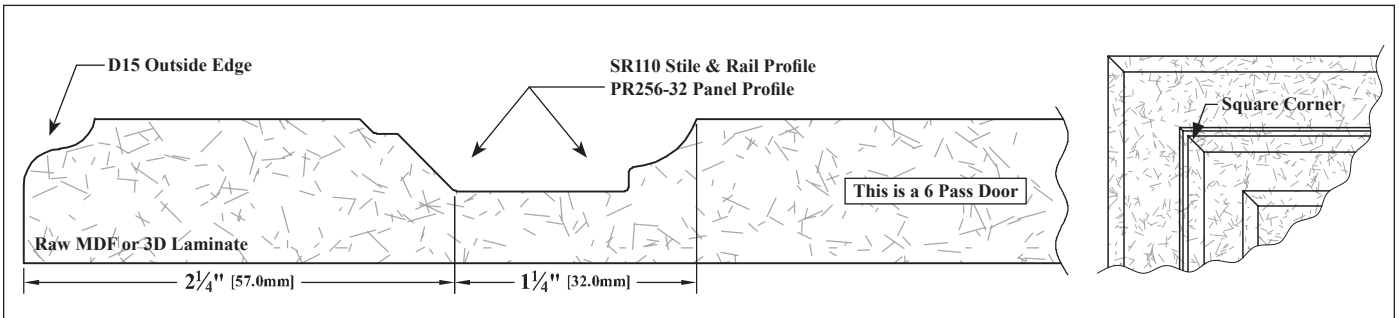
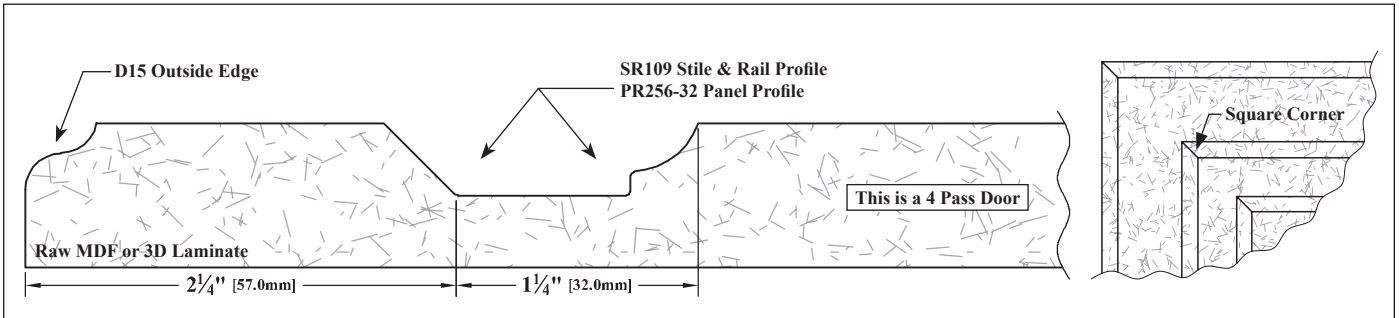
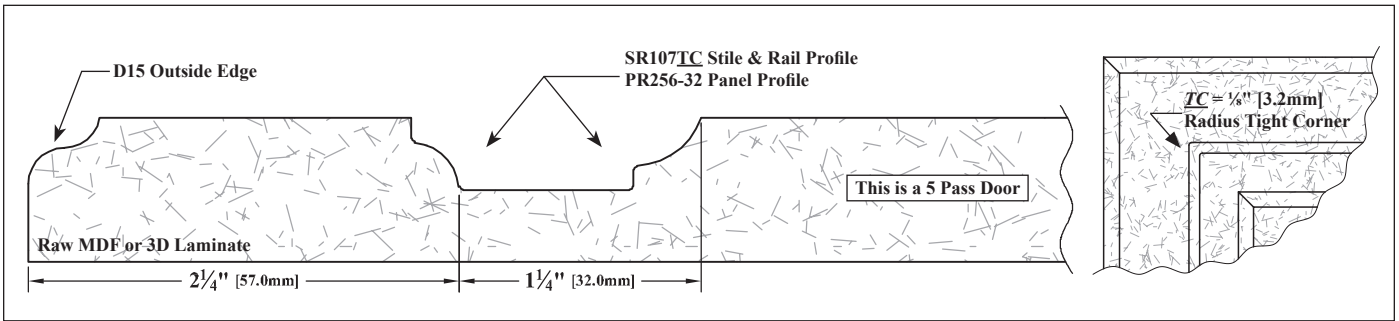
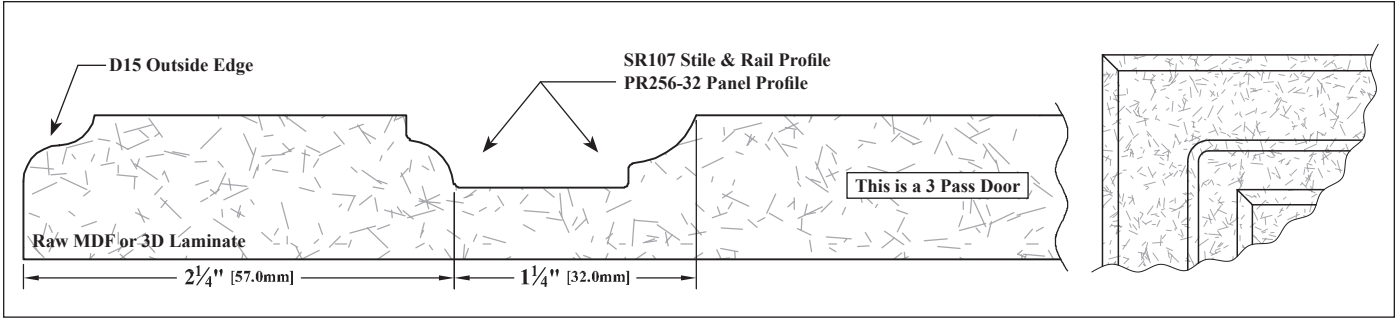

Continued on next page...

► For PRICING ► See Section V.1 in our current Wholesale Pricing Catalog.

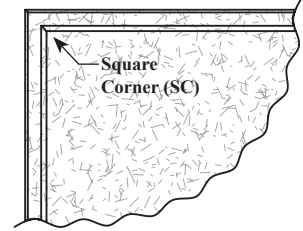
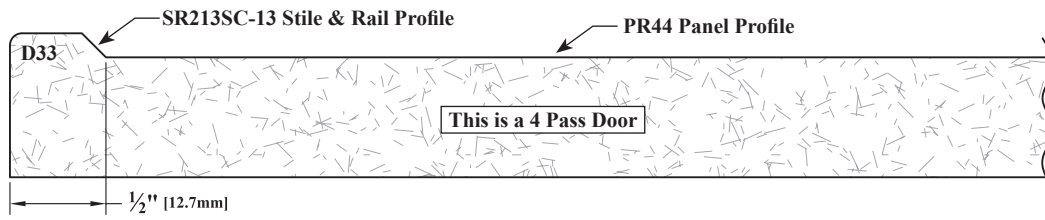

Raw MDF or 3D Laminate

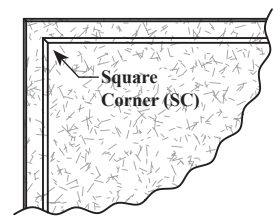
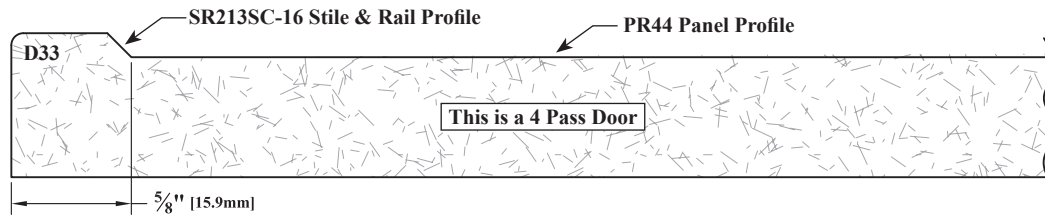

Raw MDF or 3D Laminate

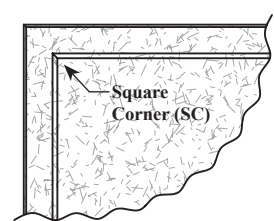
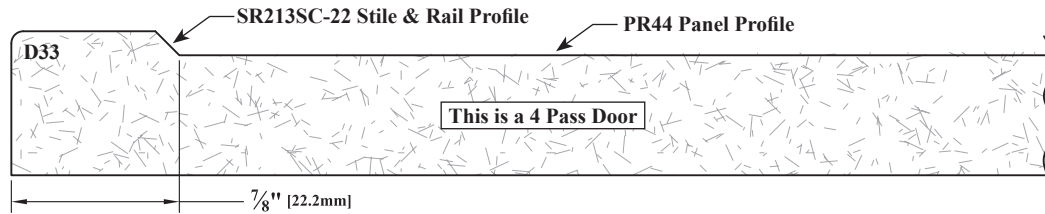

Raw MDF or 3D Laminate

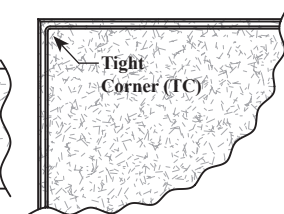
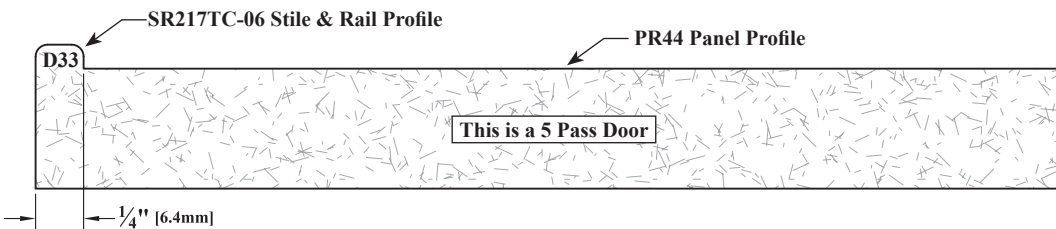

Raw MDF or 3D Laminate

TC = 1/8" Radius

V

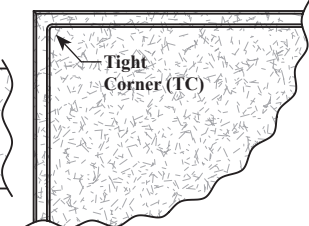
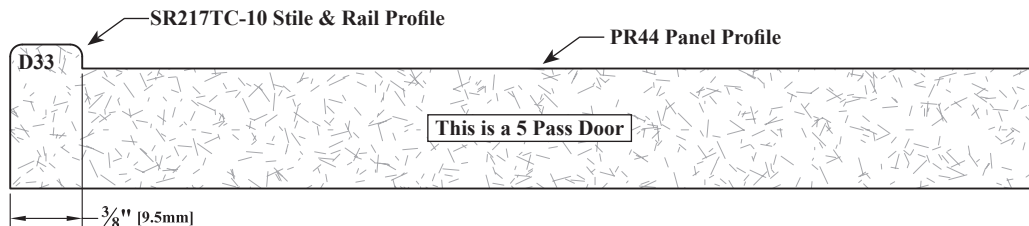

Raw MDF or 3D Laminate

TC = 1/8" Radius

► For PRICING ► See Section V.1 in our current Wholesale Pricing Catalog.

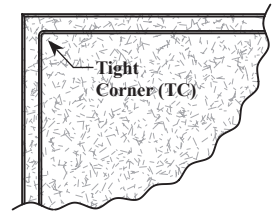
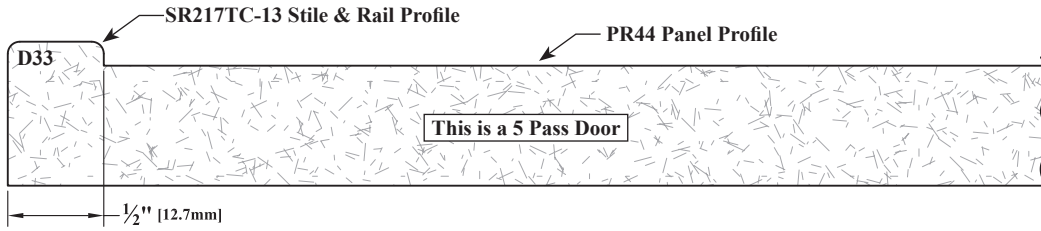

TC = 1/8" Radius

Raw MDF or 3D Laminate

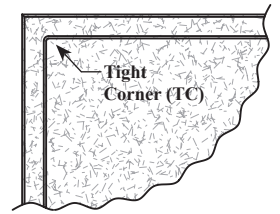
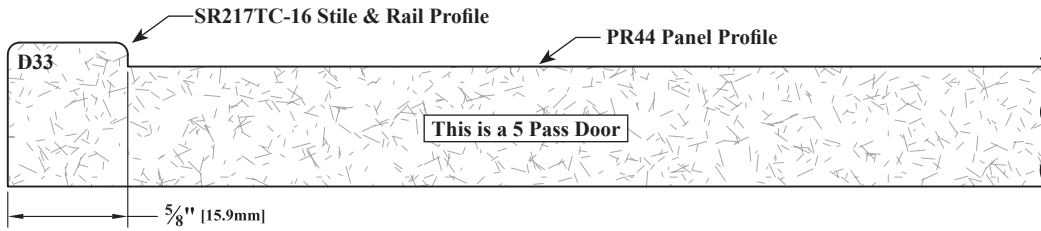

TC = 1/8" Radius

Raw MDF or 3D Laminate

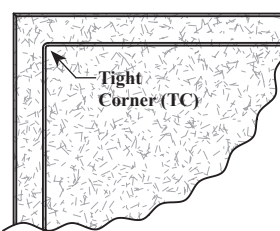
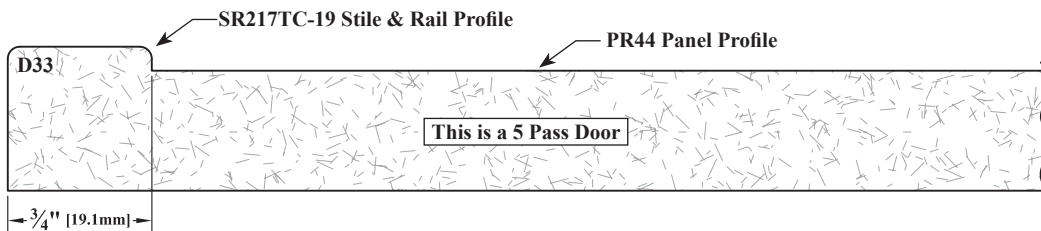

TC = 1/8" Radius

Raw MDF or 3D Laminate

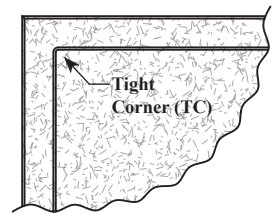
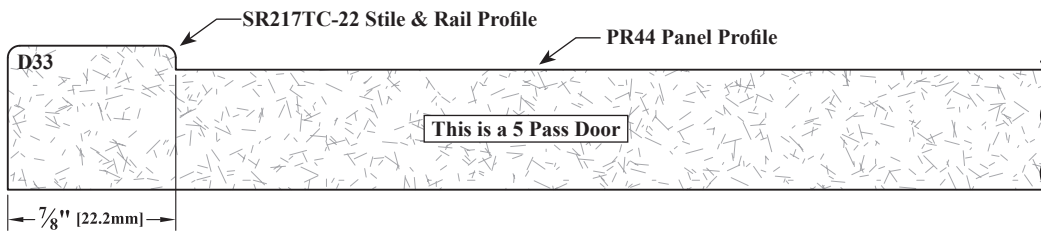

TC = 1/8" Radius

Raw MDF or 3D Laminate

Continued on next page...

V

► For PRICING ► See Section V.1 in our current Wholesale Pricing Catalog.

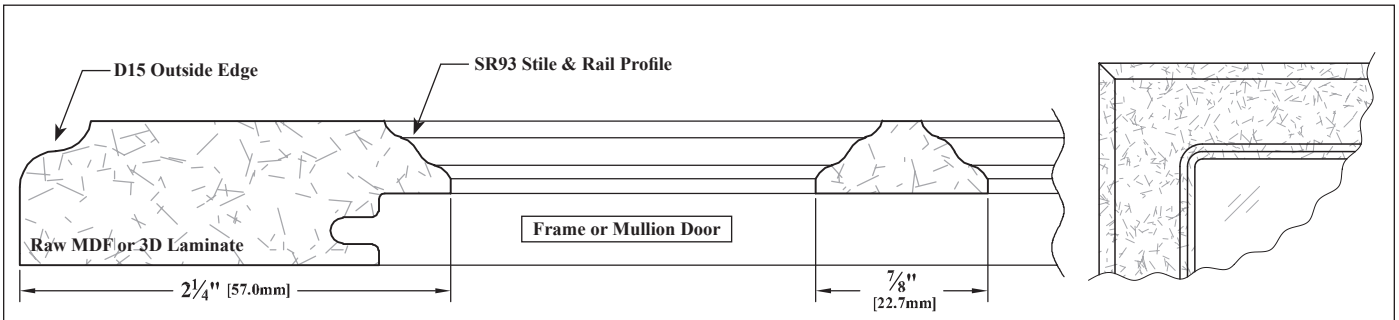
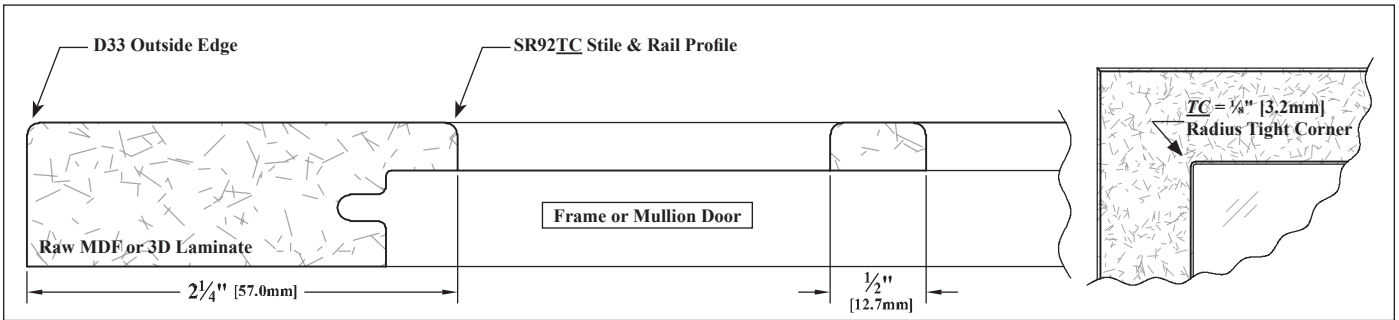
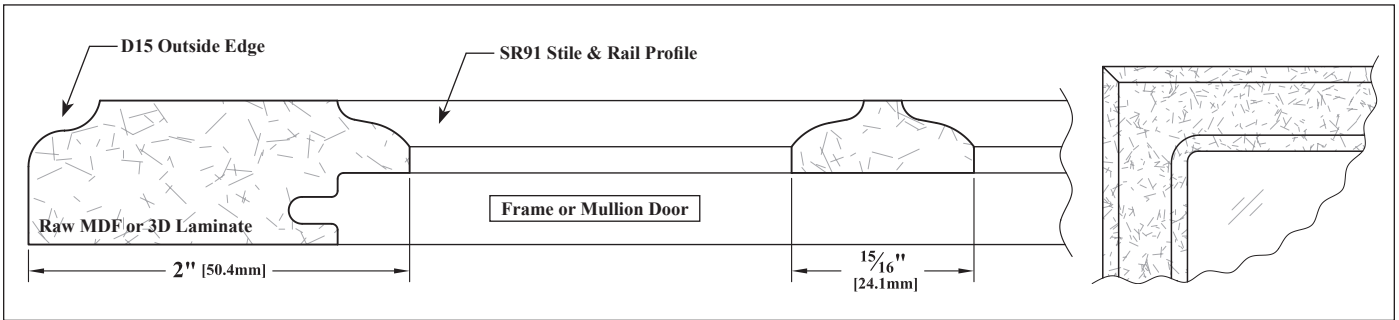
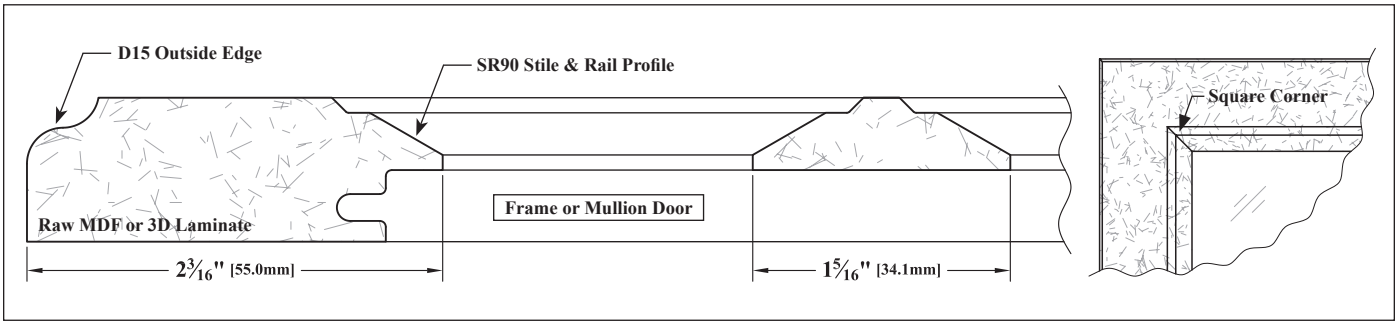
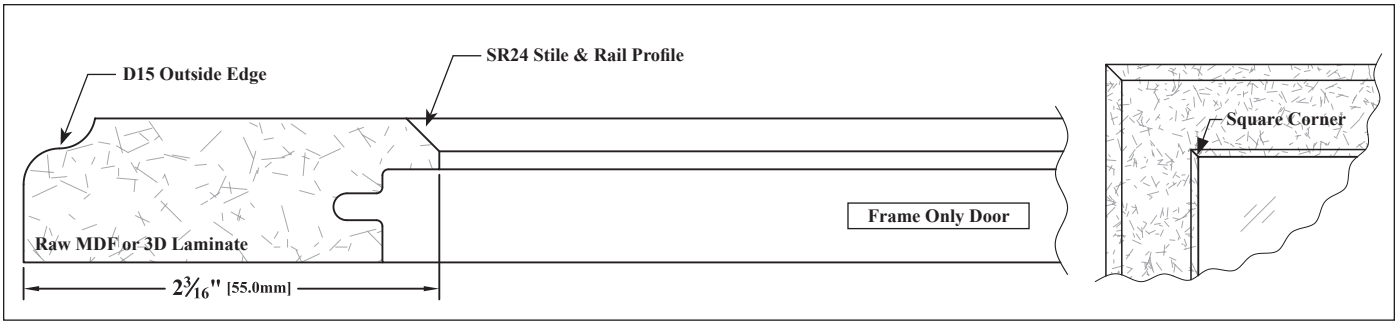

Continued on next page...

► For PRICING ► See Section V.1 in our current Wholesale Pricing Catalog.

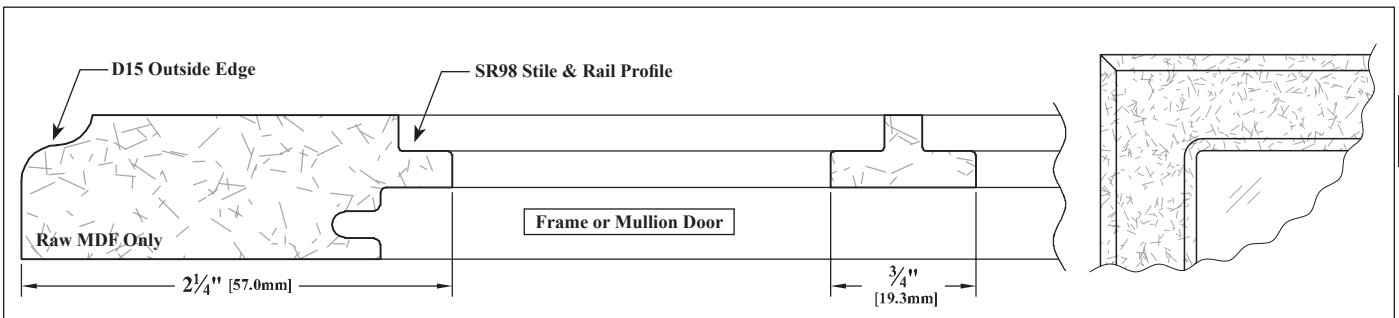
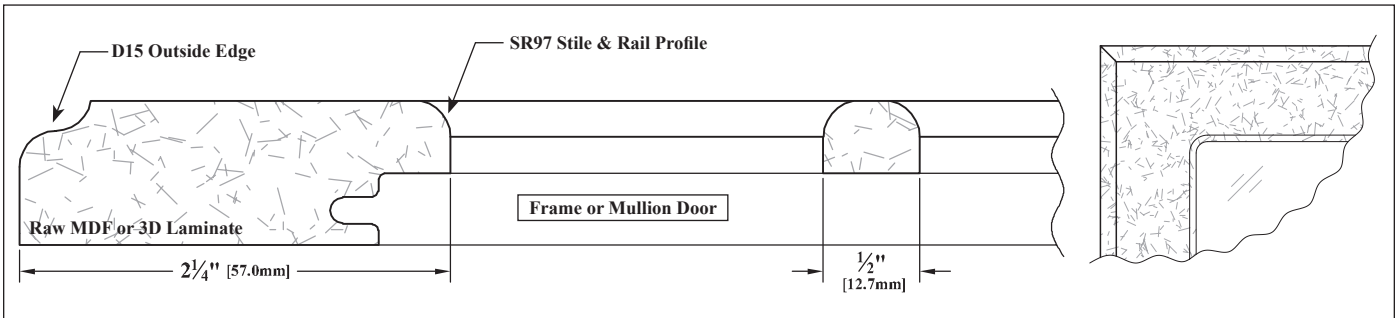
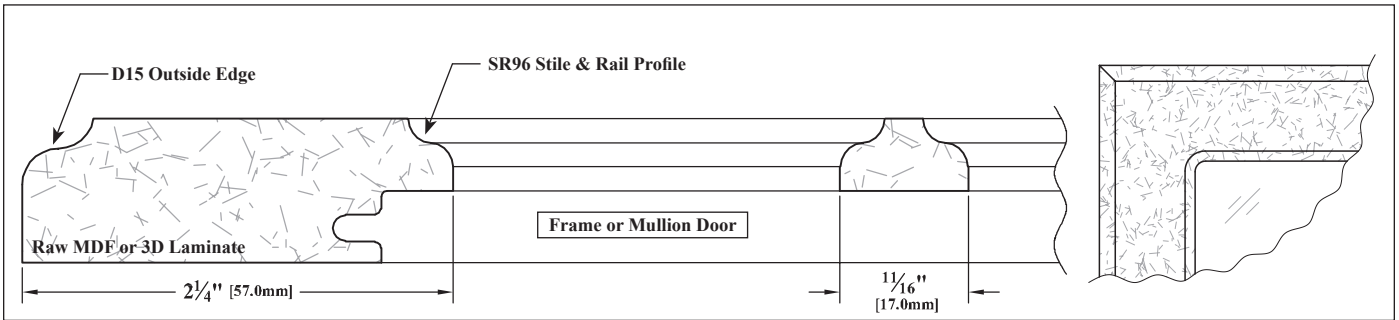
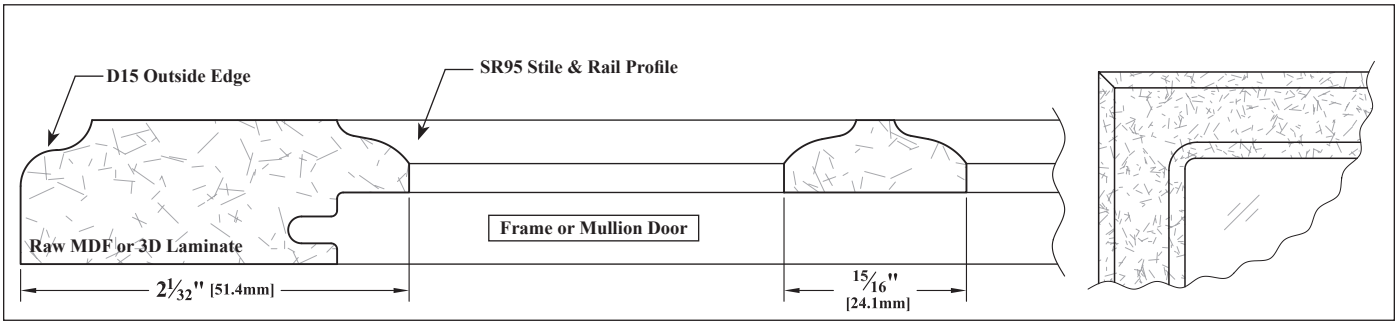
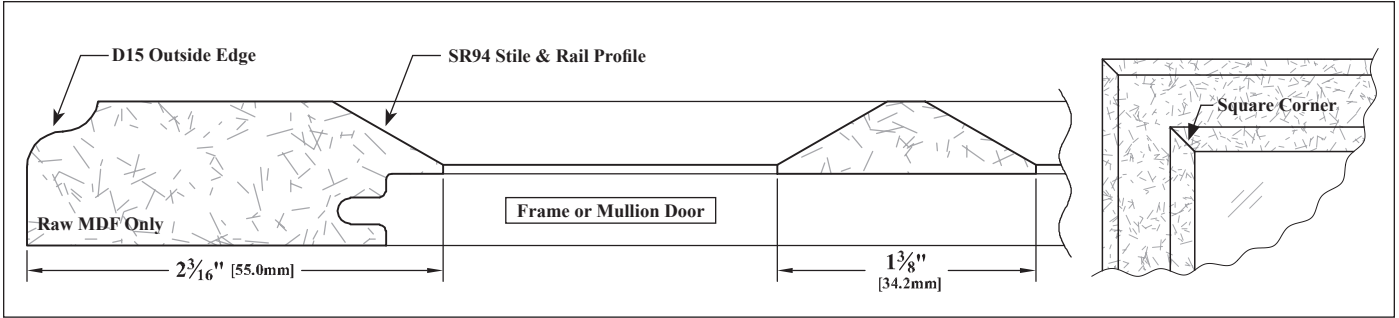

Continued on next page...

► For PRICING ► See Section V.1 in our current Wholesale Pricing Catalog.

Composite Material Options

MDF 1-Piece Doors & DFs/3D Laminate (RTF)

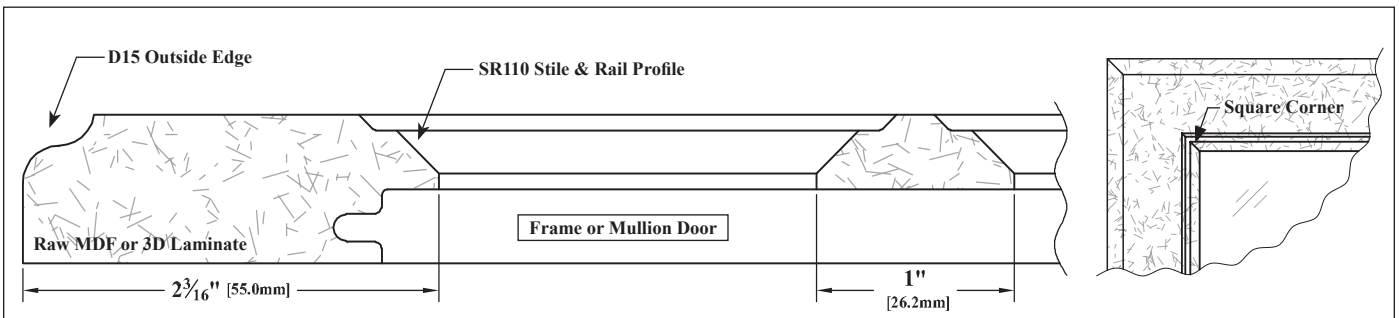
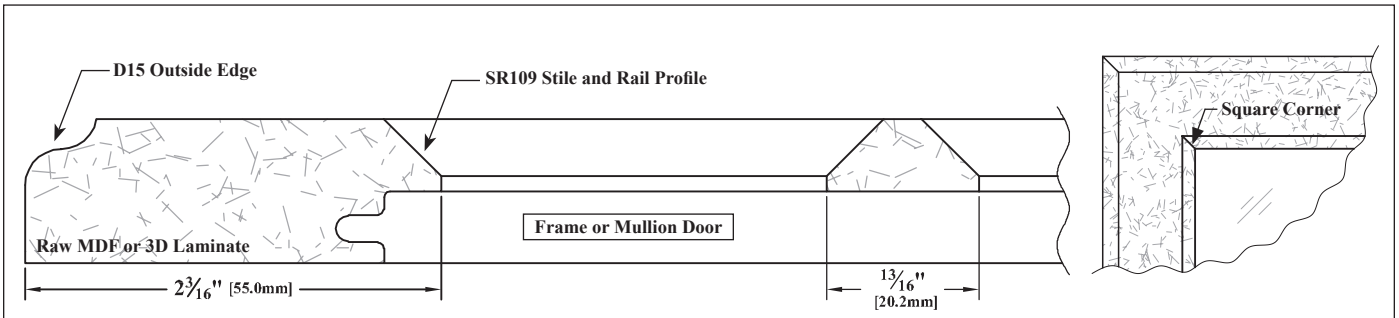
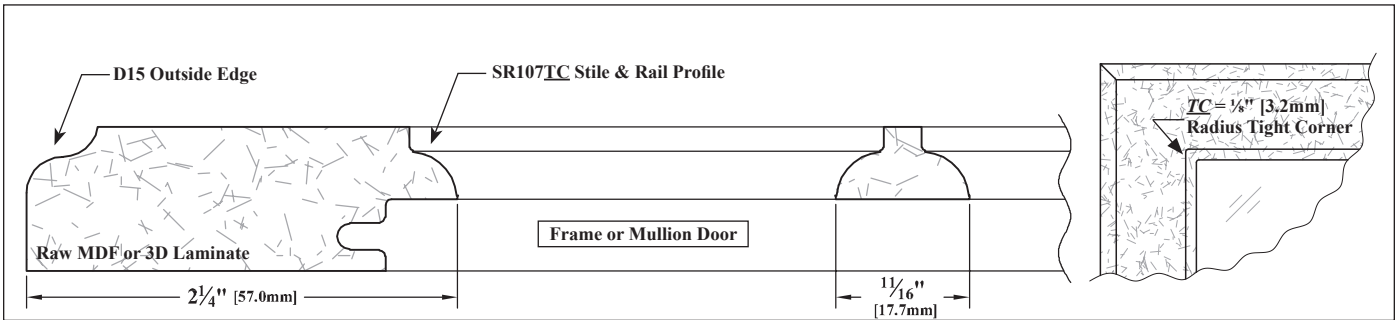
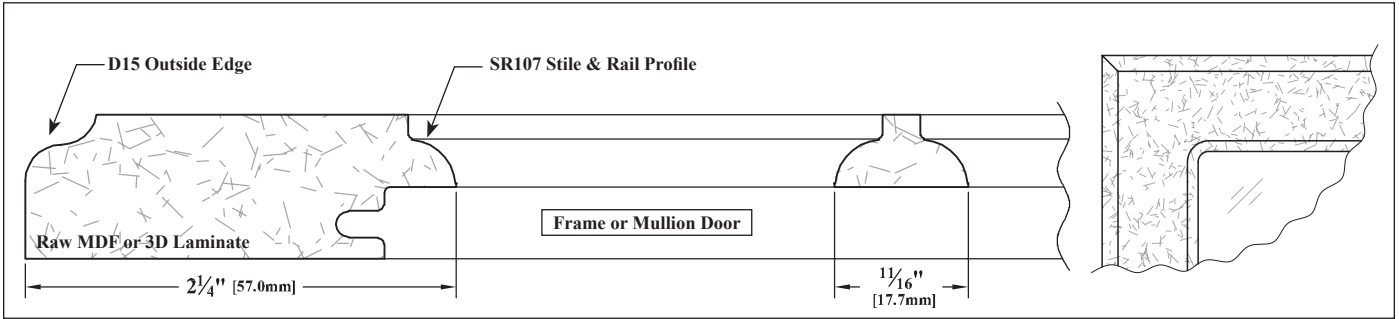
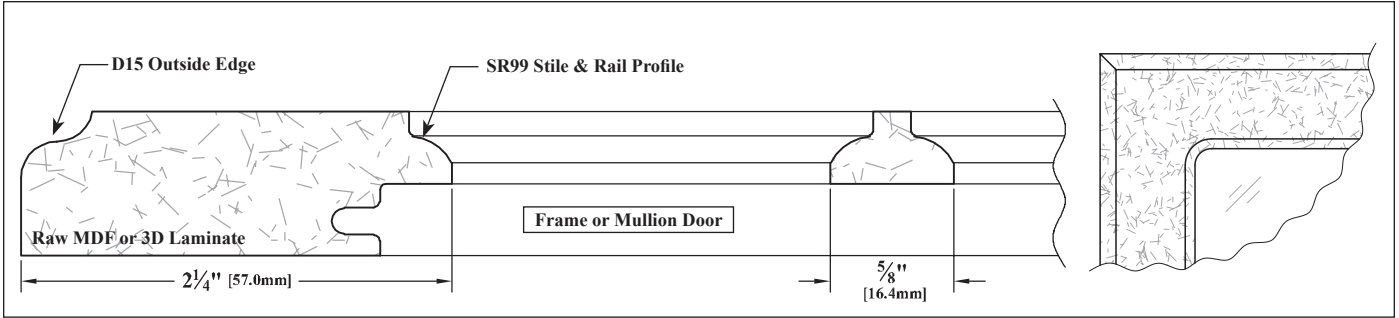

Continued on next page...

► For PRICING ► See Section V.1 in our current Wholesale Pricing Catalog.

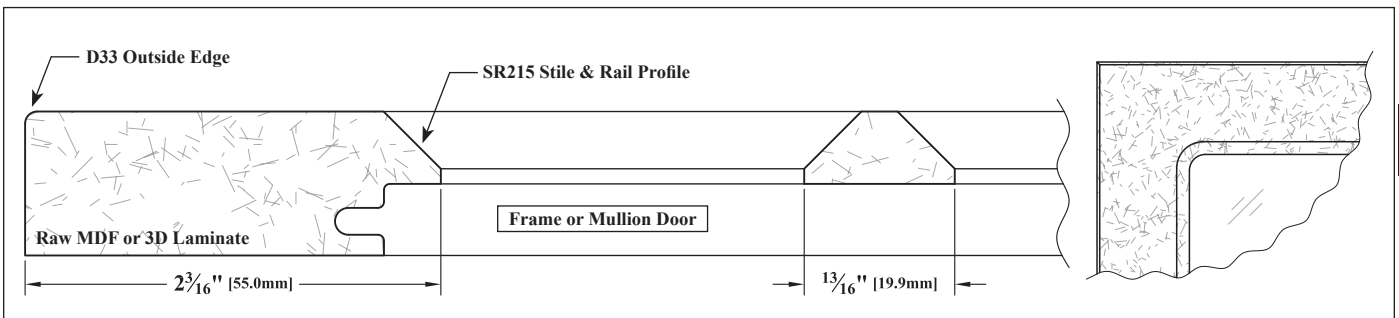
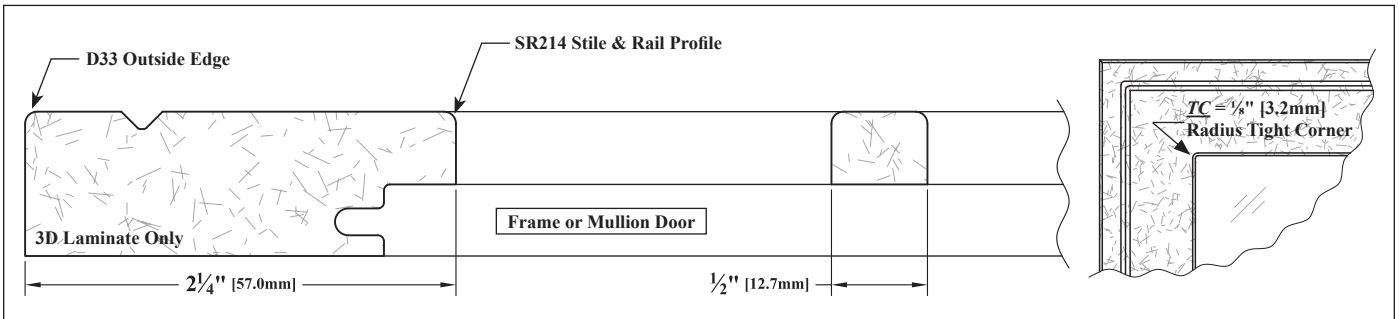
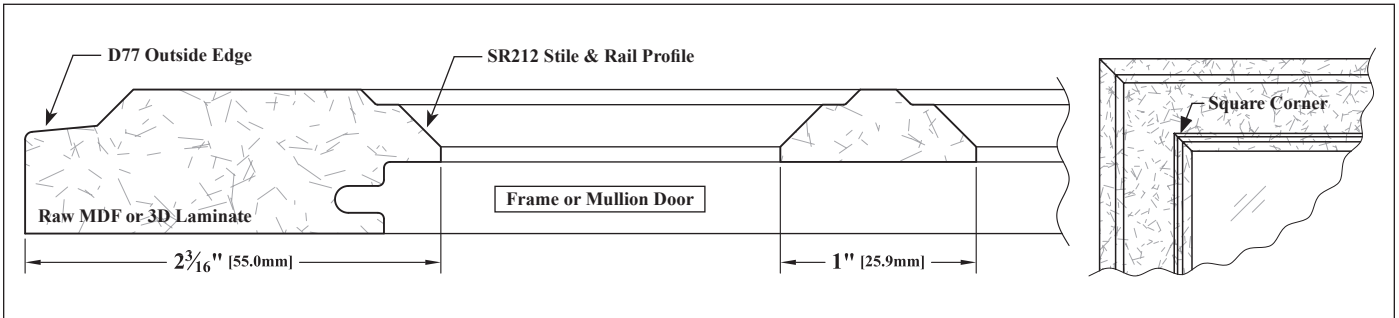
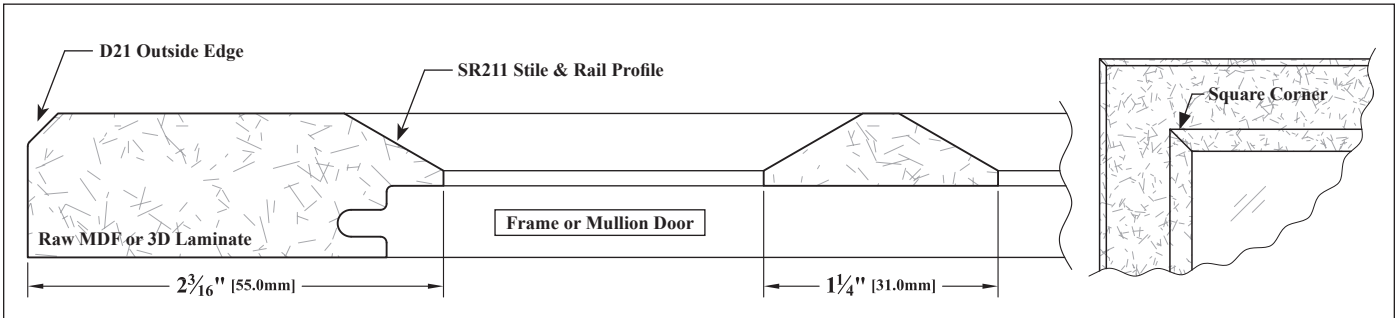
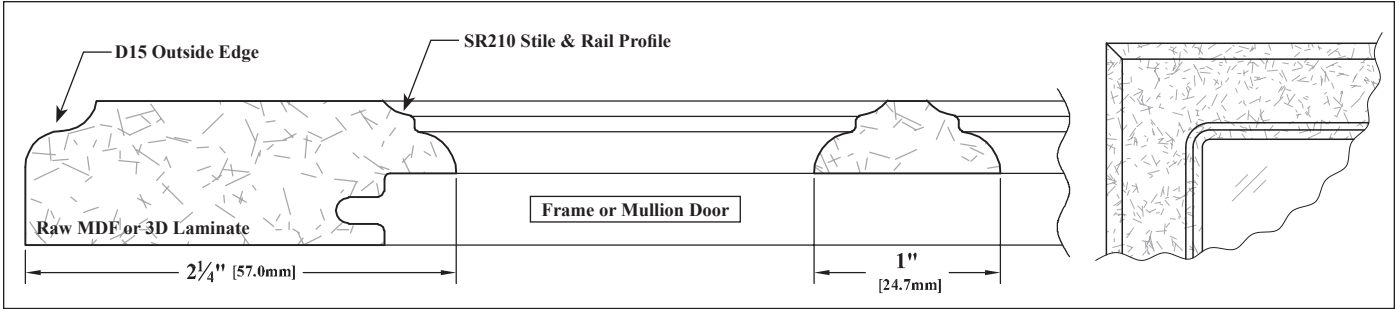

Continued on next page...

► For PRICING ► See Section V.1 in our current Wholesale Pricing Catalog.

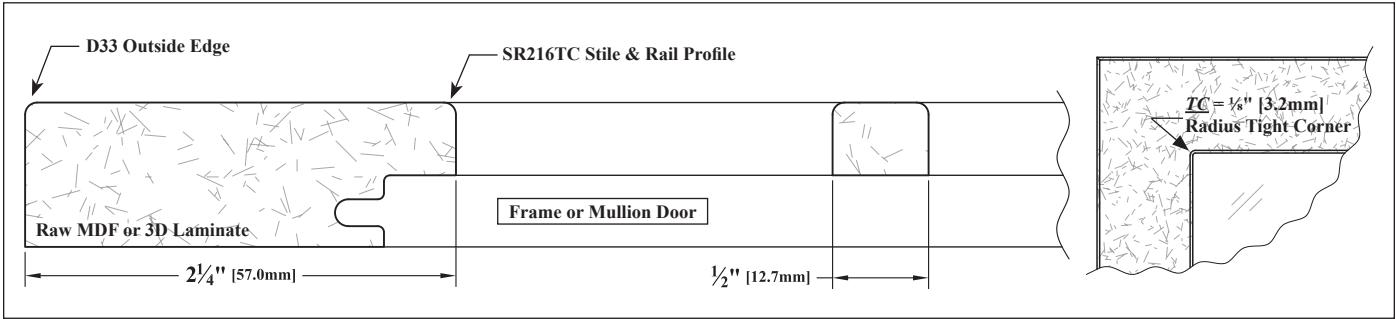
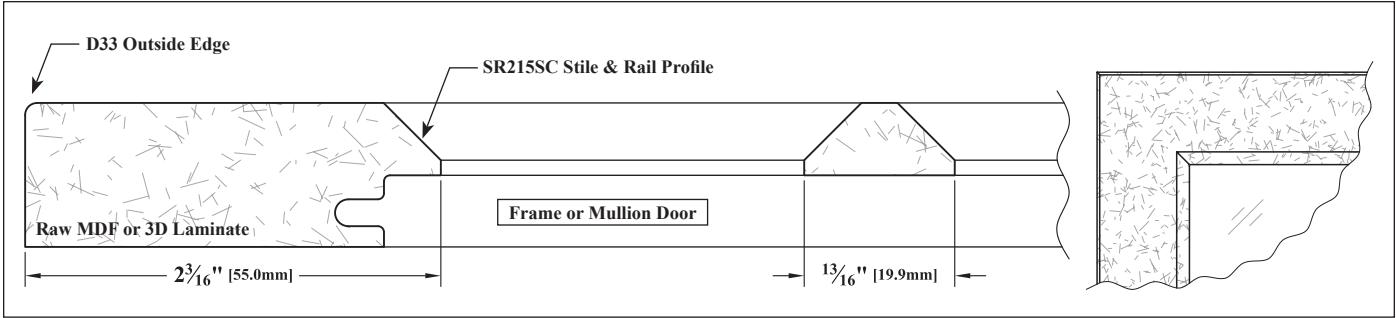

GRF (Glass Retainer Frame) and Rubber Glass Retainer

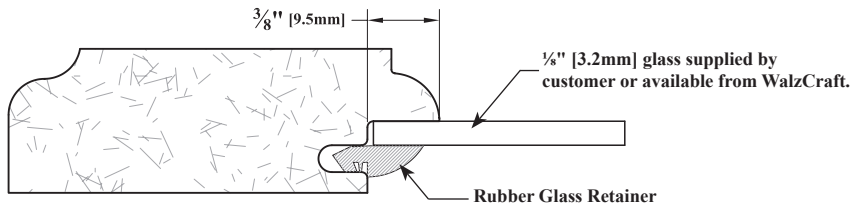

- Glass retainer fits into a slot, as shown above, and can only be used with 1/8" [3.2mm] glass.
- See **Section B.12** for glass sizing formula and more information on rubber glass retainer.
- Glass retainer is available in black, brown, clear & white.
 - You may order glass retainer by the lineal foot, or in full rolls.
 - White is available in 500 foot rolls.
 - Black, brown and clear are available in 1,000 foot rolls.
- Please see **Section B.12** of our current **Wholesale Pricing Catalog** for lineal foot pricing.

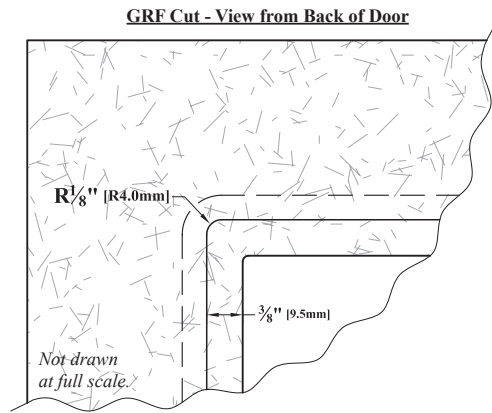

Continued on next page...

► For PRICING ► See Section V.1 in our current Wholesale Pricing Catalog.

3D Laminate (RTF) Compatible Outside Edge Profiles

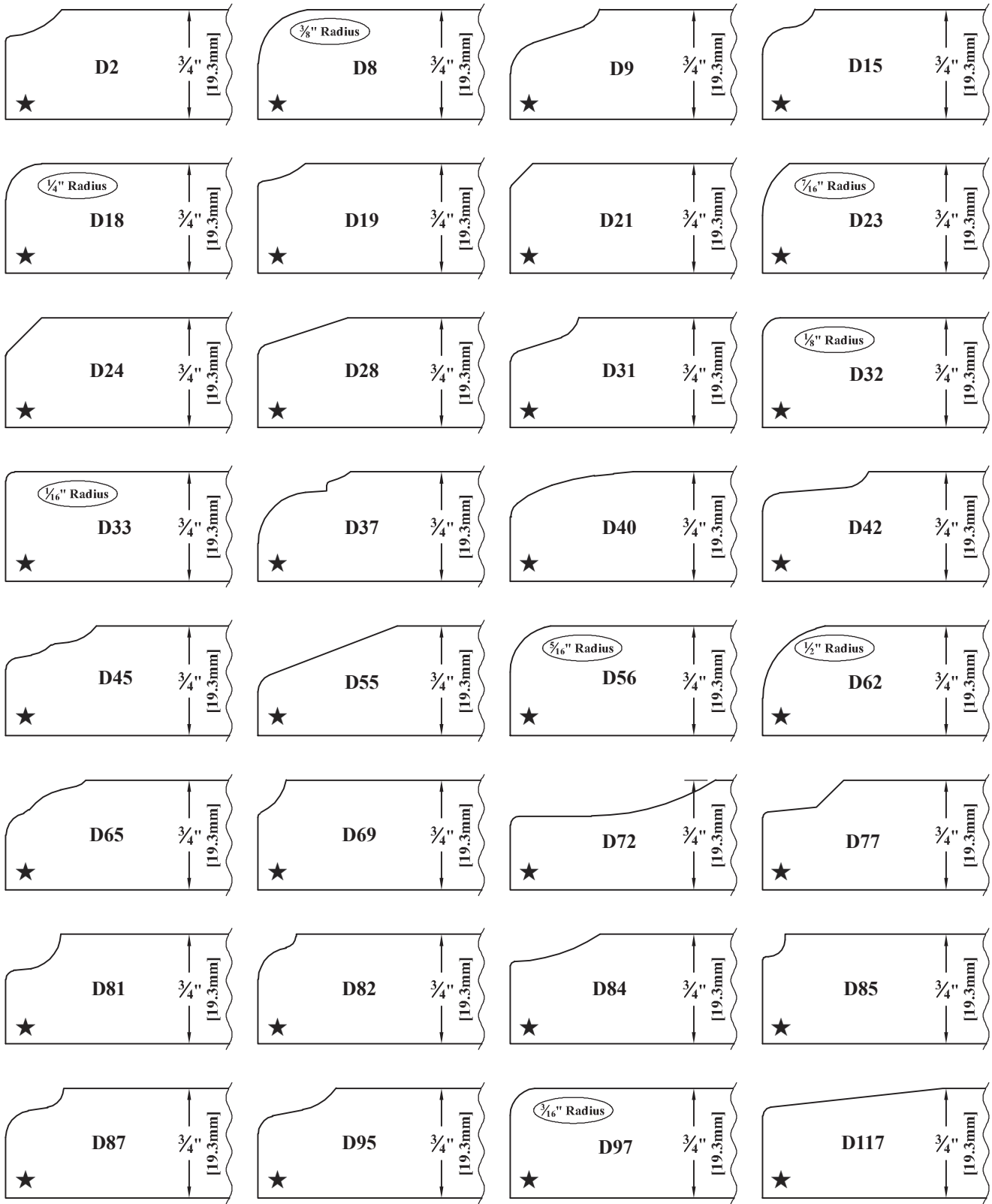

★ = Available on products using 3D Laminate (RTF).

► For PRICING ► See Section V.1 in our current Wholesale Pricing Catalog.

3D Laminate (RTF) Compatible Outside Edge Profiles

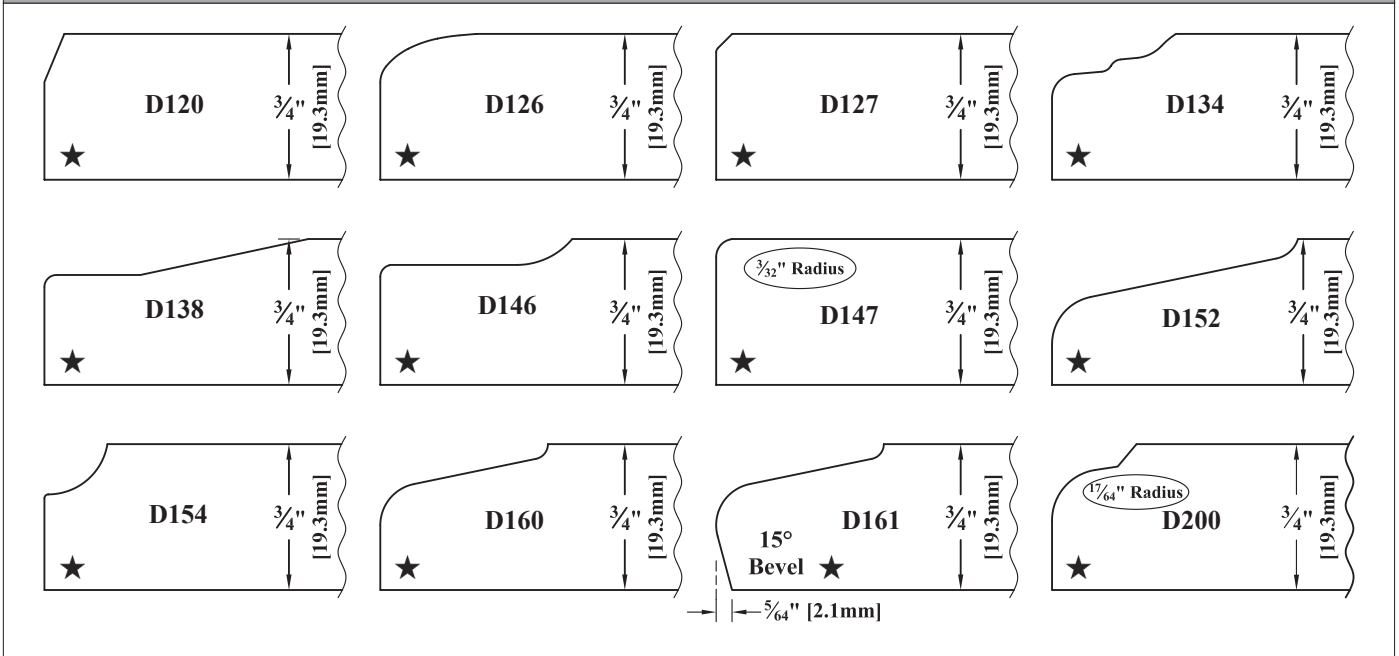

★ = Available on products using 3D Laminate (RTF).

MDF & 3D Laminate (RTF) Raised Panel (RP) Drawer Front Profiles

- Please see *Notes* at the end of this section and *Section B.16* for more information on Raised Panel (RP).
- Style Drawer Front “Looks” and available profiles in raw MDF and with 3D Laminate (RTF).

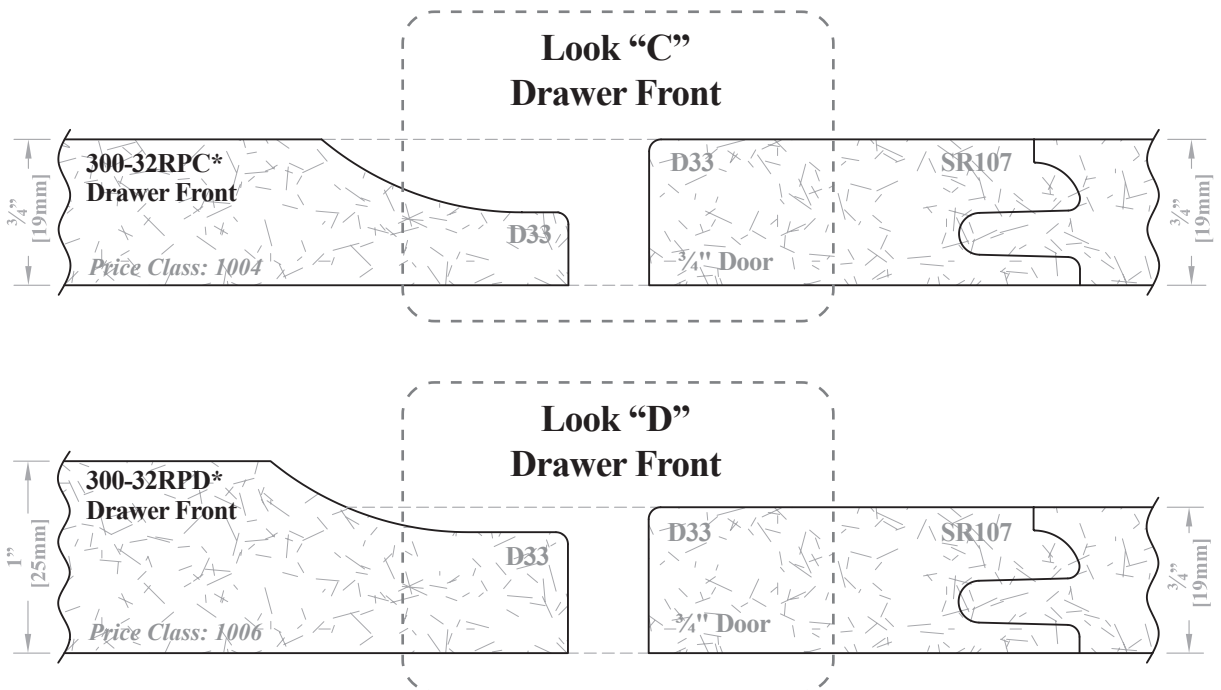

Continued on next page...

► For PRICING ► See Section V.1 in our current Wholesale Pricing Catalog.

Composite Material Options

MDF 1-Piece Doors & DFs/3D Laminate (RTF)

3D Laminate (RTF) Foil Color Options	Foil Thickness	3D Laminate (RTF) Foil Color Options	Foil Thickness	3D Laminate (RTF) Foil Color Options	Foil Thickness
Abiqua Pine* (+)	.014" [0.4mm]	Frosty White	.012" [0.3mm]	White High Gloss	.022" [0.6mm]
Almond Crystal	.012" [0.3mm]	Gauntlet Grey Super Matte	.012" [0.3mm]	White Matte	.012" [0.3mm]
Antique White	.012" [0.3mm]	Italian Macassar*	.012" [0.3mm]	White Super Matte	.012" [0.3mm]
Arctic Ribbon*	.014" [0.4mm]	Italian Wenge*	.016" [0.4mm]	White Woodgrain*	.012" [0.3mm]
Beach Glass Super Matte (+)	.012" [0.3mm]	Light Grey Super Matte	.012" [0.3mm]	Willow Grey Super Matte (+)	.012" [0.3mm]
Black Crystal	.012" [0.3mm]	Linear Ash* (+)	.012" [0.3mm]	Wilson Cherry*	.012" [0.3mm]
Black Super Matte	.012" [0.3mm]	Mysterious Super Matte	.012" [0.3mm]	* = <i>These materials have a grain/pattern direction. Please specify horizontal or vertical grain when ordering.</i>	
Canadian Grey Super Matte	.012" [0.3mm]	Natural Maple*	.014" [0.4mm]		
Celadon Green Super Matte	.012" [0.3mm]	Siena Super Matte	.012" [0.3mm]	(+)= <i>Extended Wait Time when ordered with matching back</i>	
Fashionista* (+)	.014" [0.4mm]	Summer Flame*	.012" [0.3mm]		
First Class* (+)	.014" [0.4mm]	Verde Super Matte (+)	.012" [0.3mm]		
Fjord Green Super Matte (+)	.012" [0.3mm]	Walnut*	.012" [0.3mm]		
Free Spirit* (+)	.014" [0.4mm]	White Crystal	.012" [0.3mm]		

WalzCraft 3D Laminate (RTF) and Approximate Wood Species & Finish Matches

3D Laminate Color	Wood Species & Grade			WalzCraft Stain/Finish Type
Almond Crystal	MAPLE - HARD/SOFT MIXED	Hybrid	Paint Grade	Tan - SolidTone®
Antique White	MAPLE - HARD/SOFT MIXED	Hybrid	Paint Grade	Eggshell - SolidTone®
Arctic Ribbon	NA			NA
Beach Glass Super Matte	NA			NA
Black Crystal	MAPLE - HARD/SOFT MIXED	Hybrid	Paint Grade	Black - SolidTone®
Canadian Grey Super Matte	NA			NA
Celadon Green Super Matte	NA			NA
Fjord Green Super Matte	NA			NA
Frosty White	MAPLE - HARD/SOFT MIXED	Hybrid	Paint Grade	Pearl - SolidTone®
Gauntlet Grey Super Matte	NA			NA
Italian Macassar	NA			NA
Mysterious Super Matte	NA			NA
Natural Maple	NA			NA
Siena Super Matte	NA			NA
Summer Flame	NA			NA
Walnut	WALNUT		Select/Premium Grade	Brown Oak - Wiping
White Crystal	MAPLE - HARD/SOFT MIXED	Hybrid	Paint Grade	Classic White - SolidTone®
White High Gloss	NA			NA
White Matte	MAPLE - HARD/SOFT MIXED	Hybrid	Paint Grade	Classic White - SolidTone®
White Super Matte	MAPLE - HARD/SOFT MIXED	Hybrid	Paint Grade	Classic White - SolidTone®
White Woodgrain	OAK		Budget/Value Grade	Classic White - SolidTone® WoodGrain
Wilson Cherry	NA			NA

Approximate matches determined by WalzCraft.

► For PRICING ► See Section [V.1](#) in our current Wholesale Pricing Catalog.

Ordering & Pricing Notes: MDF & 3D Laminate (RTF) Doors & Drawer Fronts

Ordering Guidelines

1	Order Forms	Please use <i>Door and/or Drawer Front Order Forms (E•Z Forms #2 and #3)</i> .
Pricing		
1	Pricing	Please see <i>Section V.1</i> of our current Wholesale Pricing Catalog.

Technical Notes: MDF & 3D Laminate (RTF) Doors & Drawer Fronts

Cabinet Accessory Options (Chapter M)

1	Appliance Panels	Style "A" and Style "C" are the only options available. See <i>Section M.15</i> .
---	------------------	-----------------------------------------------------------------------------------

Cabinet Door & Drawer Front Options (Chapter B, V)

1	Style 500*	Style 500* drawer fronts are similar to a LOOK "A" drawer front, see <i>Section B.16</i> .
2	Raised Panel (RP) Style Drawer Fronts	Raw MDF Raised Panel (RP) Drawer Fronts are available in all Drawer Front "LOOKS" found in <i>Section B.16</i> .
3	Style 500	Can be paired with the #1803, #1804 and #2211 Finger Pull Moldings and a D7 outside edge on raw MDF, or when using a D33 outside edge with a 3D Laminate (RTF). <ul style="list-style-type: none"> Finger Pull Moldings are shown on <i>page F.8.1</i>. D7 is not an option on products using 3D Laminate (RTF).
		For a raw MDF slab door with maple wood veneer edgbanding, please see <i>Section B.10 - Veneered and Edgbanding Doors</i> .
4	Style 501	Only available with fluted pattern as shown. The depth of the fluted pattern is the same as that of door Style 522, which is (approximately) 1/2" [4.0mm]. (See Flute Pattern Diagram for Style 522 on <i>page V.1.3</i>).
		Only available with a D7 outside edge for raw MDF applications, or D33 for 3D Laminate (RTF) applications.
5	Style 522	Only available with fluted pattern as shown. Hinge bores are available on the fluted side of the Style 522 door as well as the side opposite the flutes. When ordering, indicate which side of the door gets bored.
		Style 522 in raw MDF is available with all outside edge profiles from <i>Section E.15</i> . Style 522 with 3D Laminate (RTF) is only available with a D33 outside edge profile.
6	Style 525	Only available with the SR24/PR24 Profiles. The placement of the routing is as described on <i>page B.9.5</i> for the Style 1025 hardwood door.
7	Style 570 & 570*	Only available with the SR24/PR24 Profiles.
		Standard placement of the routing groove is 2 1/4" [57.2mm] from the top of the door to the center of the SR24/PR24 profile. The placement of the routing groove shown on the 570* on <i>page V.1.3</i> is 1 1/2" [38.1mm] from the top of the drawer front to the center of the SR24/PR24 profile.
8	Style 580 & 580*	Only available with the SR24/PR24 profile. <ul style="list-style-type: none"> For doors 9 1/2" [241.3mm] or higher, the standard placement of the pattern from the top/bottom of the door/drawer front will be 2 1/4" [57.2mm]. The standard radius for the four corners will be 2" [50.8mm]. A 1" [25.4mm] minimum is maintained in the flat area at the center of the pattern. (2 1/4" + 2 1/4" + 2" + 2" + 1" = 9 1/2" and up).
		<ul style="list-style-type: none"> For doors from 7 1/2" [190.5mm] up to 9 1/2" [241.3mm], the standard placement of the pattern from the top/bottom of the door/drawer front will be 2 1/4" [57.2mm]. The standard radius for the four corners will be 1" [25.4mm]. A 1" [25.4mm] minimum is maintained in the flat area at the center of the pattern. (2 1/4" + 2 1/4" + 1" + 1" + 1" = 7 1/2" minimum).
		<ul style="list-style-type: none"> For doors from a 6" [152.4mm] minimum up to 7 1/2" [190.5mm], the standard placement of the pattern from the top / bottom of the door/drawer front will be 1 1/2" [38.1mm]. The standard radius for the four corners will be 1" [25.4mm]. A 1" [25.4mm] minimum is maintained in the flat area at the center of the pattern. (1 1/2" + 1 1/2" + 1" + 1" + 1" = 6" minimum).
		The placement of the routing groove shown on the 580* on <i>page V.1.3</i> is 2 1/4" [57.2mm] from the top of the drawer front to the center of the SR24/PR24 profile.
9	Style 590	Only available with the SR24/PR24 Profiles. The placement of the routing is as described on <i>page B.9.1</i> for the Style 1050 hardwood door.

Continued on next page...

► For PRICING ► See Section V.1 in our current Wholesale Pricing Catalog.

Technical Notes: MDF & 3D Laminate (RTF) Doors & Drawer Fronts...continued

Cabinet Door & Drawer Front Options (Chapter B, V)...continued

10	Frame & Mullion Doors	The routed recessed areas on the back of 3D Laminate/RTF frame and mullion doors are painted to blend with the color / pattern on the back side of the frame or mullion door. The backs can be either White-W300 or Almond Melamine or they can match the face of the 3D Laminate/RTF door.
		Glass openings are routed to follow the contour of the shape for Styles 523, 524L, 524R, 526L, 526R, 527L, 527R, 528 .
		Rubber Glass Retainer is available with MDF/3D Laminate (RTF) Frame & Mullion doors. See <i>page V.1.19</i> .
		The standard method of placement for mullions shall be to equally divide the openings, unless specified otherwise. Custom placements are available, please provide a drawing to quote.
11	True Divided Lites	<i>Not available</i> with MDF and RTF Frame and Mullion doors.

Convex/Concave Options (Chapter D)

1	Curved Products	The ☐ indicates door styles that are available Convex/Concave (curved). See <i>Chapter D</i> for more information.
---	-----------------	--------------------------------------------------------------------------------------------------------------------

Design Options (Chapter G)

1	Radius Corners	See <i>Section G.13</i> .
2	Center Panel Face Routing - CPFR	Raw MDF Style 500/500* are the only One-Piece MDF door styles that can accept all CPFR.
		3D Laminate (RTF) Style 500/500* can accept the following CPFR patterns: CPFR100, CPFR500, CPFR600, CPFR700, CPFR1900 and CPFR2100 .

Finish Options (Chapter R)

1	3D Laminate (RTF)	When ordering MDF Drawer Fronts with 3D Laminate (RTF), the backs are available in White-W300 or Almond Melamine or matching 3D Laminate / RTF.
		The ★ indicates profiles that are available on products using 3D Laminate (RTF).
2	Primed Only for Paint & SolidTone®	See "Finishing Methods" for more information on pre-finishing MDF with "Primed Only for Paint" or "SolidTone® Colors".
3	White High Gloss 3DL (RTF)	Doors using White High Gloss 3D Laminate will have a maximum size of 24" x 42" [609.6mm x 1066.8mm] or 42" x 24" [609.6mm x 1066.8mm].
		Not available with center panel profiles PR40, PR41, PR42, PR44 .

Functional Options (Chapter F)

1	Hinge Boring	Hinge boring is available for MDF 1-Piece / 3D Laminate (RTF) doors and drawer fronts. Please see <i>Section F.1</i> for additional hinge boring requirements, ordering instructions and compatibility.
		The SR213SC and SR217TC families are not available with 35mm hinge boring at 13.5mm deep.
2	Finger Pulls	FP100, FP200, FP300, FP400, FP500 are available on all ¾" [19.1mm] or 1" [25.4mm] Raw MDF doors and drawer fronts.
		FP200 is <i>not</i> an option on ¾" [19.1mm] Raw MDF drawer front styles 300-32RP* , 301-25RP* and 302-32RP* .
		FP500 is the only finger pull rout available with 3D Laminate (RTF) doors & drawer fronts.
3	Lazy Susan Doors	3D Laminate (RTF) mitered lazy susan doors will have the back corners clipped (using MJ5), see drawings on <i>page F.6.2</i> .
		To facilitate the pressing operation, the mitered edges on the doors can not come to a sharp point.
		Lazy susan doors will come to you ¼" [1.6mm] smaller in width than the size you order. When you assemble the pair, the size will be correct because you are matching up the inside corners.

General Information (Chapter A)

1	Warranty - MDF Products	See <i>Section A.8</i> for information regarding size, warping and twisting warranties for MDF products.
---	-------------------------	----------------------------------------------------------------------------------------------------------

Material Options

1	MDF - MR	1-Piece doors and drawer fronts made from raw MDF - MR (Moisture Resistant) are not available with 3D Laminate.
---	----------	-----------------------------------------------------------------------------------------------------------------

Miscellaneous

1	Vertical Grain	<i>Leather White Alligator</i> has a distinct grain / pattern direction. When using this pattern, WalzCraft recommends vertical grain on drawer fronts when used in conjunction with vertical grain on the doors.
---	----------------	-------------------------------------------------------------------------------------------------------------------------------------------------------------------------------------------------------------------

Continued on next page...

► For PRICING ► See *Section V.1* in our current Wholesale Pricing Catalog.

Technical Notes: MDF & 3D Laminate (RTF) Doors & Drawer Fronts...continued

Profile Options (Chapter E)...continued

1	“Passes”	“Passes” refer to the number of CNC Router cycles required to complete a door. Complex doors require more “Passes”.
2	MDF Outside Edge Profiles	<ul style="list-style-type: none"> • Most outside edge profiles shown in <i>Section E.15 & E.16</i> are available on MDF products. • Limitations apply for raised panel drawer fronts, see the compatibility chart on our website. • If ordering an applied molding outside edge on an MDF product, the applied molding will be made from a Maple-Hard/Soft-Mixed Paint Grade Wood Species.
3	Additional Outside Edges	<ul style="list-style-type: none"> • An additional outside edge may be placed on any of the four edges of your door/drawer front. <ul style="list-style-type: none"> ◦ Left, Right, Top and Bottom. • Only two different outside edges may be used at the same time on any given product.
		<p>Raw MDF:</p> <ul style="list-style-type: none"> • When using a D7 or D33 as one of your edges, any outside edge from <i>Section E.15</i> may be used for the other edge(s). • When neither of the outside edge profiles are a D7 or D33, the two profiles must be identical on the front side. <ul style="list-style-type: none"> ◦ Example: D19 is identical to D20, just without the rabbet on the back. ◦ Additional compatible combinations: D15/D58, D45/D46, D31/D3, D31/D27, D31/D90, D17/D110, D17/D144, D97/D180
		<p>3D Laminate:</p> <ul style="list-style-type: none"> • When using a D33 as one of your edges, any outside edge from <i>Section V.1</i> may be used for the other edge(s). • No other profile combinations are compatible with 3D Laminate products.
4	AM Outside Edge Options	For solid wood applied molding outside edge options on raw MDF, please see <i>Section E.16</i> .
5	Raised Panel (RP) Style Drawer Front Profiles	You must choose an RP “ Look ”, a Raised Panel Profile, and an Outside Edge Profile when ordering RP (Raised Panel) Drawer Fronts. The Raised Panel Profile # and the “ Look ” option define the Style # for your RP Drawer Front.
		See <i>Section B.16</i> for RP drawer front profiles. Raw MDF RP drawer fronts are available in all Drawer Front “ LOOKS ”.
6	PR40 Center Panel Profile	<p>Only available with 3D Laminate (RTF) material.</p> <ul style="list-style-type: none"> • See <i>Finish Options</i> notes within this section for 3D Laminate (RTF) restrictions. • If looking for a raw MDF door with a flat panel, please see the PR42 center panel profile within this section or refer to <i>Section B.3</i> for 5-piece raw MDF flat panel doors. <p>Max size for products with a PR40 center panel profile is 18" x 36" [457.2mm x 914.4mm] or 36" x 18" [914.4mm x 457.2mm].</p>
		<p>Only available with 3D Laminate (RTF) material.</p> <ul style="list-style-type: none"> • See <i>Finish Options</i> notes within this section for 3D Laminate (RTF) restrictions. • Available in the following door styles: 518, 520, 521, 531. • If looking for a raw MDF door with a flat panel, please see the PR42 center panel profile within this section or refer to <i>Section B.3</i> for 5-piece raw MDF flat panel doors. <p>Maximum size for products with a PR41 center panel profile is 24" x 42" [609.6mm x 1066.8mm] or 42" x 24" [1066.8mm x 609.6mm].</p> <ul style="list-style-type: none"> • For door styles 518, 520 and 521, when combining PR41 with SR92TC the maximum size may be increased to 24" x 60" [609.6mm x 1524.0mm] or 60" x 24" [1524.0mm x 609.6mm]. • Doors over 48" will require a center rail or stile (ex: door style 520, 521).
8	PR42 Center Panel Profile	<p>When combining the PR42 center panel profile with the SR92TC stile & rail profile, 1-piece MDF doors and drawer fronts are only available in raw MDF (for SolidTone® application).</p> <ul style="list-style-type: none"> • When combining the PR42 center panel profile with the SR211, SR212, SR215 or SR215SC stile & rail profile, 1-piece MDF doors and drawer fronts are available in raw MDF (for SolidTone® application) or with 3D Laminate. • See <i>Finish Options</i> notes within this section for 3D Laminate (RTF) restrictions. • Please also refer to <i>Section B.3</i> for 5-piece raw MDF flat panel doors.
		<p>Maximum size for raw MDF products with a PR42 center panel profile is 24" x 70" [609.6mm x 1778.0mm].</p> <ul style="list-style-type: none"> • Since raw MDF does not have a grain direction, the max dimensions can be 24"W x 70"H or 70"W x 24"H. • When one dimension is greater than 24", the other dimension must be 24" or less. • Doors from 42½" to 70" (high or wide) will carry no warranty.
		<p>Maximum size for 3D Laminate products with a PR42 center panel profile is 24" x 42" [609.6mm x 1066.8mm] or 42" x 24" [1066.8mm x 609.6mm].</p>

Continued on next page...

V

► For PRICING ► See Section [V.1](#) in our current Wholesale Pricing Catalog.

Technical Notes: MDF & 3D Laminate (RTF) Doors & Drawer Fronts...continued

Sizes/Dimensions

1	Maximum Sizes	<ul style="list-style-type: none"> The maximum size of a raw MDF product is 48"W x 96"H [1219.2mm x 2438.4mm]. The maximum size of a 3D Laminate (RTF) product is 40"W x 90"H [1016mm x 2286mm].
		<p>The maximum width for 1-Piece MDF doors /drawer fronts that WalzCraft will warrant is 24". The maximum height for 1-Piece MDF doors /drawer fronts that WalzCraft will warrant is 72".</p> <ul style="list-style-type: none"> Sizes greater than this will carry no warranty against warping or twisting. See Section A.8 for more information on warping and twisting tolerances.
		<p>3D Laminate (RTF) products with a grain /pattern direction that exceed 40" [1016mm] in width, will be manufactured with a "horizontal" pattern due to maximum size limitations.</p>
2	Panel Opening	<ul style="list-style-type: none"> MDF & 3D Laminate (RTF) doors and drawer fronts are a one piece constructed product. If choosing a door style with a flat panel, the minimum panel opening size that can be accommodated would be 1" [25.4mm]. The minimum panel opening size for a door style with a raised panel would be 1" [25.4mm] of flat on the face of the raised panel, plus the panel profile reveals.
3	Stile & Rail	The minimum <i>width</i> at the narrowest, for any top /bottom rail with or without a GRF cut is 1¼" [31.8mm].
		The minimum <i>width</i> at the narrowest, for any outside or center stile or center rail with or without a GRF cut is 1½" [38.1mm].
4	SR213, SR217 Families	These two profile families do not accommodate width flexibility. Only available at the widths shown.
5	Thicknesses	Doors and drawer fronts in raw MDF are available ¾" [19.1mm] and 1" [25.4mm] thick. <ul style="list-style-type: none"> Raw MDF Style 500/500* will also be available ⅝" and ⅜" thick when using one of the compatible Applied Molding Outside Edge profiles for ⅝" or ⅜" thick raw MDF or solid wood slabs from Section E.16.
		Doors and drawer fronts with 3D Laminate (RTF) are available ¾" [19.1mm] thick only.

MDF & 3D Laminate (RTF) Doors & Drawer Fronts - END

► For PRICING ► See Section [V.1](#) in our current Wholesale Pricing Catalog.

3D Laminate (RTF) Sheet Stock



3D Laminate Color /Pattern	Loose Foil Thickness	3D Laminate Color /Pattern	Loose Foil Thickness	3D Laminate Color /Pattern	Loose Foil Thickness
Abiqua Pine	.014" [0.4mm]	Fjord Green Super Matte	.012" [0.3mm]	Summer Flame	.012" [0.3mm]
Almond Crystal	.012" [0.3mm]	Free Spirit	.014" [0.4mm]	Verde Super Matte	.012" [0.3mm]
Antique White	.012" [0.3mm]	Frosty White	.012" [0.3mm]	Walnut	.012" [0.3mm]
Arctic Ribbon	.014" [0.4mm]	Gauntlet Grey Super Matte	.012" [0.3mm]	White Crystal	.012" [0.3mm]
Beach Glass Super Matte	.012" [0.3mm]	Italian Macassar	.012" [0.3mm]	White High Gloss	.022" [0.6mm]
Black Crystal	.012" [0.3mm]	Italian Wenge	.016" [0.4mm]	White Matte	.012" [0.3mm]
Black Super Matte	.012" [0.3mm]	Light Grey Super Matte	.012" [0.3mm]	White Super Matte	.012" [0.3mm]
Canadian Grey Super Matte	.012" [0.3mm]	Linear Ash	.012" [0.3mm]	White Woodgrain	.012" [0.3mm]
Celadon Green Super Matte	.012" [0.3mm]	Mysterious Super Matte	.012" [0.3mm]	Willow Grey Super Matte	.012" [0.3mm]
Fashionista	.014" [0.4mm]	Natural Maple	.014" [0.4mm]	Wilson Cherry	.012" [0.3mm]
First Class	.014" [0.4mm]	Siena Super Matte	.012" [0.3mm]		

Ordering & Pricing Notes: 3D Laminate (RTF) Sheet Stock

Ordering Guidelines

1	Order Forms	Please use <i>Sheet Goods Order Form (E•Z Form #8.2)</i> and use part #89.
----------	--------------------	----------------------------------------------------------------------------

Pricing

1	Pricing	Please see <i>Section V.1</i> of our current Wholesale Pricing Catalog .
----------	----------------	---------------------------------------------------------------------------------

Technical Notes: 3D Laminate (RTF) Sheet Stock

Finish Options (Chapter R)

1	Colors/Patterns	See chart above for available 3D Laminate Colors/Patterns.
----------	------------------------	------------------------------------------------------------

Miscellaneous

1	Cutting 3D Laminates	When cutting 3D Laminate sheet stock, WalzCraft recommends using a laminate slitter, razor knife or table saw.
----------	-----------------------------	----------------------------------------------------------------------------------------------------------------

Material Options

1	Material Availability	<p>3D Laminate (RTF) is available as a non-adhesive loose foil (no backer material), loose foil with a 3M PSA (peel & stick) back, loose foil with a non-adhesive phenolic back and loose foil with a 3M PSA phenolic back.</p> <ul style="list-style-type: none"> • Please note that for the loose foil with a 3M PSA phenolic back, the PSA material on the back of the sheet may have some wrinkling, but this should not telegraph through to the face when applied.
----------	------------------------------	---------------------------------------------------------------------------------------------------------------------------------------------------------------------------------------------------------------------------------------------------------------------------------------------------------------------------------------------------------------------------------------------------------------------------------------------------------------------------------------------

Continued on next page...

► **For PRICING** ► See *Section V.1* in our current **Wholesale Pricing Catalog**.

Technical Notes: 3D Laminate (RTF) Sheet Stock...Continued

Sheet Stock Options (Chapter K)

1	Custom Pressing	3D Laminate (RTF) is available custom pressed on ¼" thick through 1" thick MDF core or Combi-Core sheet stock. See <i>Custom Pressed Section K.3</i> .
----------	------------------------	--------------------------------------------------------------------------------------------------------------------------------------------------------

Sizes/Dimensions...continued

1	Thickness	3D Laminate thickness varies by color/pattern. See color/pattern availability chart. Phenolic material measures approximately .020" thick (does not include foil thickness).
2	4' x 8' Sheet Sizes	4'x8' sheets of 3D Laminate Loose Foil will measure anywhere from 51" to 57" wide x 97" long, depending on the pattern. 4'x8' panels are considered 95% free from defect. All other 3D Laminate sheet stock products will start out as, or will be taken from, a 49" x 97" sheet. Some edges may need to be trimmed.
3	RCSS - Rough Cut Stock Size	A sheet that is only available in the following sizes: 4'x8', 2'x8', 4'x4', 2'x4'. Edges may need to be trimmed. Some sheets may be slightly oversized. Allow ⅛" per saw kerf.
4	RTRW - Ripped to Rough Width	Available in customer specified widths x 8' long only. Edges may need to be trimmed. Specified widths will not be oversized. Some lengths may be slightly oversized. Minimum width for 3D Laminate is ¾". Allow ⅛" per saw kerf.
5	PCTS - Precision Cut to Size	Available in customer specified widths and lengths (any size piece that the sheet will yield). No trimming of edges is needed. Pieces will not be oversized. Minimum width for 3D Laminate is ¾". Allow ⅛" per saw kerf. Precision Cut to Size (PCTS) 3D Laminate is only available in the "3D Laminate Loose Foil with Phenolic Back" option.

3D Laminate (RTF) Sheet Stock - END

► For PRICING ► See Section [V.1](#) in our current Wholesale Pricing Catalog.

Decorative Laminate Veneer (DLV) Doors & Drawer Fronts

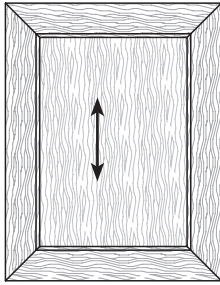

Style: 41M

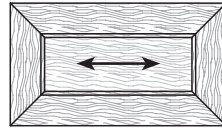

Style: 41M*
Drawer Front

Decorative Laminate Veneer (DLV) Flat Panel Mitered Doors

- Available in 5 Colors
- 2 Stile & Rail Profiles (w/ GRF Options)
- Accessories
 - 4' x 8' Sheets of Matching Melamine
 - 4' x 8' Sheets of Laminate (Non-Adhesive)
 - 4' x 8' Sheets of Laminate (3M PSA)
 - Edgbanding Rolls
 - Stile & Rail Profile Stock (9' Lengths Only)

Decorative Laminate Veneer (DLV) Colors/Textures

Coffee Groovz
(AuthenTICK Texture)

White
(Suede Texture)

Aria
(Medina Texture)

Licorice Groovz
(AuthenTICK Texture)

Arctic Groovz
(AuthenTICK Texture)

Features of Decorative Laminate Veneer (DLV) Doors, Drawer Fronts & Accessories

Materials

Stile and rail profiles are manufactured using a premium grade of MDF. The MDF is profiled to tight tolerances, and then “wrapped” with Decorative Laminate Veneer (DLV) using precision profile wrapping machines. Door center panels are 6mm thick Thermally Fused Melamine (TFM) that perfectly matches the Decorative Laminate Veneer. These are prefinished products that require no additional finishing.

Note: Other matching complimentary products exist within the industry, such as HPL, edgbanding, 3DL and other thicknesses of TFM. These products use the same names and numbers as noted in the chart below.

Decorative Laminate Veneer (DVL) / Prism Laminates Cross Reference

DLV/Prism Color	Coffee Groovz	White	Aria	Licorice Groovz	Arctic Groovz
DLV/Prism Texture	AuthenTICK	Suede	Medina	AuthenTICK	AuthenTICK
Prism Number	WF395	W100	WF340	WF392	WF394

Please note that Prism was formerly Flakeboard.

Construction

Doors and drawer fronts use mitered construction similar to that used for all WalzCraft solid wood doors and drawer fronts that utilize mitered construction. This ensures that the grain direction on all the parts of a 5-piece door are similar to the grain direction on a solid wood door. The combination of precisely wrapped stile and rail stock combined with WalzCraft’s carefully monitored miter machining and assembly process produces joints of exceptional quality.

Quality Features of Decorative Laminate Veneer (DLV) Doors and Drawer Fronts

- **Construction:** Five-piece miter construction. Stiles & rails with perpendicular grain direction provide the overall look of a finished wood door.
- **Dimensional Stability:** Premium MDF means less expansion and contraction and doors stay flatter than wood doors.
- **Heat Resistance:** Great resistance to delamination up to 185° Fahrenheit.
- **Color Consistency:** Color consistency and fade resistance similar to melamine. Better color stability over time than solid wood doors.
- **Environment:** All components meet Carb2 standards for an environmentally friendly product.
- **Bacteria Resistance:** DLV products have an anti-microbial additive that is good for the life of the product.
- **Easy Care:** Clean with a non-abrasive detergent and a damp sponge or cloth.
- **Scratch Resistance:** Decorative Laminate Veneers are extremely scratch resistant.

Continued on next page...

► For PRICING ► See Section [V.2](#) in our current Wholesale Pricing Catalog.

Decorative Laminate Veneer (DLV) Stile & Rail Profiles

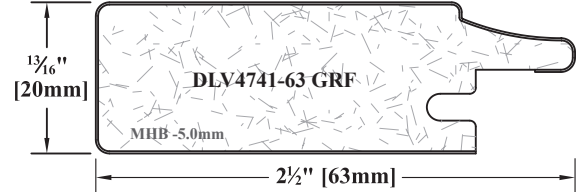
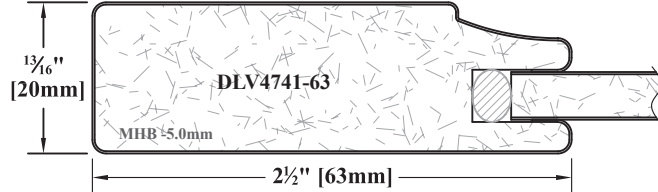
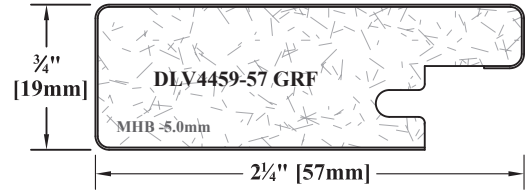
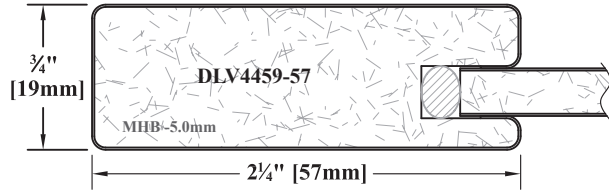

MHB = Minimum hinge bore setback at 12.7mm deep.

Ordering & Pricing Notes: Decorative Laminate Veneer (DLV) Doors & Drawer Fronts

Ordering Guidelines

1	Order Forms	Please use <i>Door and/or Drawer Front Order Forms (E-Z Forms #2 and #3)</i> .
Pricing		
1	Pricing	Please see <i>Section V.2</i> of our current Wholesale Pricing Catalog .

Technical Notes: Decorative Laminate Veneer (DLV) Doors & Drawer Fronts

Cabinet Door & Drawer Front Options (Chapter B)

1	Door Styles	Available as Style 41M Flat Panel Mitered doors and Style 41M* Flat Panel Miter drawer fronts only.
---	-------------	-------------------------------------------------------------------------------------------------------------------

Convex/Concave Options (Chapter D)

1	Convex/Concave	Decorative Laminate Veneer (DLV) doors and drawer fronts are not available convex/concave.
---	----------------	--------------------------------------------------------------------------------------------

Dealer Aid Options (Chapter T)

1	Promotional Items	Stile & Rail Profile Sample Sets are available upon request and include one 6" length of the following profile/color combinations: DLV4300-73/Coffee Groovz , DLV4858-38/White , DLV4546-76/Aria , DLV4459-57/Licorice Groovz and DLV4741-63/Arctic Groovz . See <i>Product Samples - Section T.2</i> for more information. Use part #184580.
---	-------------------	----------------------------------------------------------------------------------------------------------------------------------------------------------------------------------------------------------------------------------------------------------------------------------------------------------------------------------------------------------------------------------

Design Options (Chapter G)

1	Stile & Rail Profile Stock	Stile & Rail Profile Stock is available with or without the GRF cut in 9' [2743.2mm] lengths only. 9' [2743.2mm] lengths can only ship via Spee•Dee or common carrier.
---	----------------------------	------------------------------------------------------------------------------------------------------------------------------------------------------------------------

Finish Options (Chapter R)

1	Colors/Textures	Available in the five colors shown at the beginning of this section. Each color is only available in the texture that it's noted with.
2	Finish Options	All Decorative Laminate Veneer products are prefinished. No additional finishing is needed.
3	3D Laminate Matches	Three of our DLV colors/patterns have approximate matches in 3D Laminate (RTF). <ul style="list-style-type: none"> Using an approximately matching 3D Laminate molding with your DLV products will greatly increase the number of molding options available to you.
		★ = Moldings available with 3D Laminate (RTF). See <i>Chapter N</i> for options and for more information.
		<ul style="list-style-type: none"> White (Suede Texture) DLV is an approximate match to Frosty White 3D Laminate (RTF). Licorice Groovz (AuthenTICK Texture) DLV is an approximate match to Linear Ash 3D Laminate (RTF). Arctic Groovz (AuthenTICK Texture) is an approximate match to Free Spirit 3D Laminate (RTF).
We recommend viewing a sample of each color/pattern before placing an entire order.		

► For PRICING ► See Section **V.2** in our current Wholesale Pricing Catalog.

Technical Notes: Decorative Laminate Veneer (DLV) Doors & Drawer Fronts...continued

Functional Options (Chapter F)

1	Hinge Boring	Decorative Laminate Veneer (DLV) doors and drawer fronts are only available with the 35mm hinge bore options (HBP100 - HBP500). Please see <i>Section F.1</i> for additional hinge boring requirements, ordering instructions and compatibility.
---	--------------	--------------------------------------------------------------------------------------------------------------------------------------------------------------------------------------------------------------------------------------------------

General Information (Chapter A)

1	Grain Direction	Arrows (←→) shown throughout the catalog indicate standard grain direction. Grain direction may be specified at NO additional cost.
2	Ready to Assemble (RTA)	Ready to Assemble (RTA) is available as an option for DLV doors and drawer fronts. Assemble machined joints with wood glue.

Profile Options (Chapter E)

1	Stile & Rail Profiles	Available in two stile & rail profiles along with GRF options.
---	-----------------------	----------------------------------------------------------------

Sizes/Dimensions

1	Thickness	Only available in the thicknesses indicated on the profile drawings.
2	Stile & Rail Widths	Stile & rail widths are fixed at the sizes indicated on the profile drawings.
3	Minimum Door & DF Sizes per Stile & Rail Profile	DLV4459-57: 6" x 6" [152.4mm x 152.4mm] DLV4741-63: 6½" x 6½" [165.1mm x 165.1mm]
4	Maximum Size	The maximum size for Style 41M doors and drawer fronts with <i>vertical grain</i> is 48"W x 80"H [1219.2mm x 2032.0mm]. The maximum size for Style 41M doors and drawer fronts with <i>horizontal grain</i> is 80"W x 48"H [2032.0mm x 1219.2mm]. Doors and drawer fronts ordered over 48" in either width or height will carry <i>no warranty</i> and will have the stiles or rails secured to the panel, on the backside, with headless pins.

DLV Edgebanding Rolls

Color	Texture	Type	Thickness	Width	Roll Length	Backing	EB Part #
Arctic Groovz	AuthenTICK	Unglued	0.018"	1 ⁵ / ₁₆ "	600' +/- 5%	PVC	185223
Aria	Medina	Unglued	0.018"	1 ⁵ / ₁₆ "	600' +/- 5%	PVC	185221
Coffee Groovz	AuthenTICK	Unglued	0.018"	1 ⁵ / ₁₆ "	600' +/- 5%	PVC	185219
Licorice Groovz	AuthenTICK	Unglued	0.018"	1 ⁵ / ₁₆ "	600' +/- 5%	PVC	185222
White	Suede	Unglued	0.018"	7 ⁸ / ₁₆ "	600' +/- 5%	PVC	185220

Ordering & Pricing Notes: Decorative Laminate Veneer Edgebanding

Ordering Guidelines

1	Order Forms	Please use <i>Molding & Miscellaneous Order Form (E-Z Form #5)</i> .
---	-------------	--------------------------------------------------------------------------

Pricing

1	Pricing	Please see <i>Section V.2</i> of our current Wholesale Pricing Catalog .
---	---------	---------------------------------------------------------------------------------

Technical Notes: Decorative Laminate Veneer Edgebanding

Finish Options

1	Finish Options	All Decorative Laminate Veneer products are prefinished. No additional finishing is needed.
---	----------------	---------------------------------------------------------------------------------------------

Material Options

1	Backing	Available unglued with a PVC backing only. Currently we do not offer a pre-glued DLV edgebanding that requires heat activation.
---	---------	------------------------------------------------------------------------------------------------------------------------------------

Sizes/Dimensions

1	Length of Rolls	600' rolls will be 600 feet long +/- 5%.
1	Widths	Widths vary, but all can be trimmed and applied to doors or end panels.

Continued on next page...

► For **PRICING** ► See *Section V.2* in our current Wholesale Pricing Catalog.

Decorative Laminate Veneer (DLV) Sheet Stock

Sheet Stock Availability		Laminate Sheets with Paper Back			
		Non-Adhesive .025" [0.6mm] Thick		3M Pressure Sensitive Adhesive (PSA) .025" [0.6mm] Thick	
		RCSS	RTRW	RCSS	RTRW
Sheet Stock Size		RCSS	RTRW	RCSS	RTRW
Color	Texture				
Arctic Groovz	AuthenTICK	X	X	X	X
Aria	Medina	X	X	X	X
Coffee Groovz	AuthenTICK	X	X	X	X
Licorice Groovz	AuthenTICK	X	X	X	X
White	Suede	X	X	X	X

Sheet Stock Availability		Melamine																				
		1/4" Melamine .236" [6.0mm] Thick +/- .015" (4' x 8')			1/2" Melamine .500" [12.7mm] Thick +/- .015" (4' x 8')			1/2" Melamine .528" [13.4mm] Thick +/- .015" (4' x 8')			5/8" Melamine .626" [15.9mm] Thick +/- .015" (4' x 8')			5/8" Melamine .658" [16.7mm] Thick +/- .015" (4' x 8')			3/4" Melamine .752" [19.1mm] Thick +/- .015" (4' x 8')			3/4" Melamine .752" [19.1mm] Thick +/- .015" (5' x 8')		
		RCSS	RTRW	PCTS	RCSS	RTRW	PCTS	RCSS	RTRW	PCTS	RCSS	RTRW	PCTS	RCSS	RTRW	PCTS	RCSS	RTRW	PCTS	RCSS	RTRW	PCTS
Sheet Stock Size		RCSS	RTRW	PCTS	RCSS	RTRW	PCTS	RCSS	RTRW	PCTS	RCSS	RTRW	PCTS	RCSS	RTRW	PCTS	RCSS	RTRW	PCTS	RCSS	RTRW	PCTS
Color	Texture																					
Arctic Groovz - 2S (Arctic on Two Sides)	MDF Core	X	X	X																		
	Particle Board Core																X	X	X			
Aria - 2S (Aria on Two Sides)	MDF Core	X	X	X																		
	Particle Board Core																X	X	X			
Coffee Groovz - 2S (Coffee on Two Sides)	MDF Core	X	X	X																		
	Particle Board Core																X	X	X			
Licorice Groovz - 2S (Licorice on Two Sides)	MDF Core	X	X	X																		
	Particle Board Core																X	X	X			
White - 2S (White on Two Sides)	MDF Core	X	X	X																		
	Particle Board Core							X	X	X				X	X	X				X	X	X

Ordering & Pricing Notes: Decorative Laminate Veneer (DLV) Sheet Stock

Ordering Guidelines

1 Order Forms Please use *Sheet Goods Order Form (E-Z Form #8.2)* and part #185.

Pricing

1 Pricing Please see *Section V.2* of our current **Wholesale Pricing Catalog**.

Technical Notes: Decorative Laminate Veneer (DLV) Sheet Stock

Finish Options (Chapter R)

- 1 Colors/Textures Available in the five colors shown at the beginning of this section. Each color is only available in the texture that it's noted with.
- 2 Finish Options All Decorative Laminate Veneer products are prefinished. No additional finishing is needed.

Sheet Stock Options (Chapter K)

1	Laminate Sheets with Paper Back, Non-Adhesive	Rough Cut Stock Sizes (RCSS)	Only available in the following sizes: 4'x8', 2'x8', 4'x4', 2'x4'.
		Ripped to Rough Width (RTRW)	Available in customer specified widths x 8' long only.
2	Laminate Sheets with Paper Back, 3M PSA	Rough Cut Stock Sizes (RCSS)	Only available in the following sizes: 4'x8', 2'x8', 4'x4', 2'x4'.
		Ripped to Rough Width (RTRW)	Available in customer specified widths x 8' long only.
3	Matching Melamine (2S)	Rough Cut Stock Sizes (RCSS)	Only available in the following sizes: 4'x8', 2'x8', 4'x4', 2'x4'.
		Ripped to Rough Width (RTRW)	Available in customer specified widths x 8' long only.
		Precision Cut to Size (PCTS)	Available in customer specified widths and lengths (any size piece that the sheet will yield).
4	Custom Pressed	Laminate sheets of DLV are available custom pressed on 1/4" thick through 1" thick MDF sheet stock. See <i>Custom Pressed Section K.3</i> .	

Decorative Laminate Veneer (DLV) - END

► For PRICING ► See Section **V.2** in our current Wholesale Pricing Catalog.

Composite Material Options

High Pressure Laminate (HPL)

High Pressure Laminate (HPL) Doors & Drawer Fronts

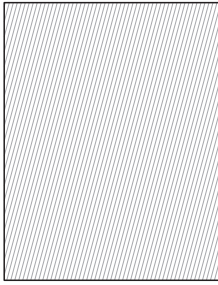

Style: 2224
 5/8" Thick with HPL-2 PC:700
 5/8" Thick with HPL-4 PC:701
 3/4" Thick with HPL-2 PC:710
 3/4" Thick with HPL-4 PC:711
 Frame PC: NA
 Min. Size: 3x3
 [76.2mm x 76.2mm]

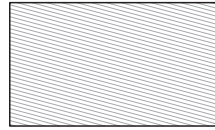

Style: 2224*
Drawer Front
 5/8" Thick with HPL-2 PC:700
 5/8" Thick with HPL-4 PC:701
 3/4" Thick with HPL-2 PC:710
 3/4" Thick with HPL-4 PC:711
 Frame PC: NA
 Min. Size: 3x3
 [76.2mm x 76.2mm]

High Pressure Laminate (HPL) Stock Colors /Finishes

#8843-WR	#8842-WR	#7813-SP	#949-58	#5343-MC	#6212-58
Natural Ash (Woodbrush Finish)	Weathered Ash (Woodbrush Finish)	Cardboard (Sculpted Finish)	White (Matte Finish)	Possum (Micro Dot Finish)	Wheat Strand (Matte Finish)

High Pressure Laminate (HPL) Door Manufacturing Options

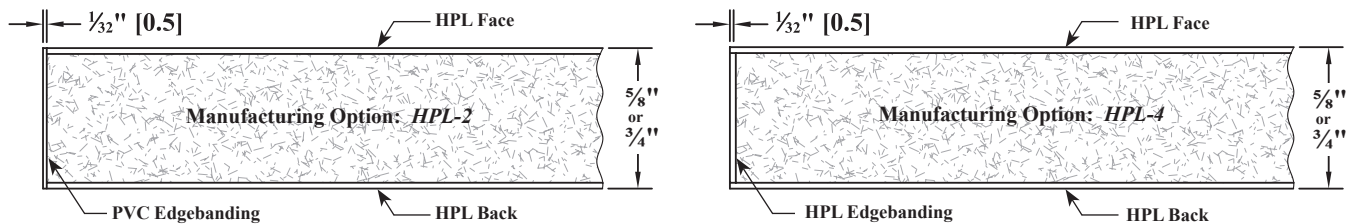

Ordering & Pricing Notes: High Pressure Laminate Doors & Drawer Fronts

Ordering Guidelines

1	Order Forms	Please use Door and/or Drawer Front Order Forms (E•Z Forms #2 and #3) .
2	Ordering Information	Please provide our Customer Support Team with the <u>below</u> material and manufacturing options for your order or quote. <ul style="list-style-type: none"> • Thickness: 5/8" (+/- .015") or 3/4" (+/- .015"). • HPL manufacturer: Formica, Wilsonart, Nevamar, or another manufacturer of your choice. • HPL color name and number along with finish type (ex: Formica #6212-58, Wheat Strand-Matte Finish). <ul style="list-style-type: none"> ◦ If the HPL color has a pattern or grain, you will need to specify grain direction. ◦ Not available with metallic or high gloss laminate. • Manufacturing Option: HPL-2 or HPL-4 (please see detail drawings).

Pricing

1	Pricing	Please see Section V.3 of our current Wholesale Pricing Catalog for the six stock Formica colors shown. <ul style="list-style-type: none"> • For any other manufacturer, color or finish, please submit the Ordering Information referenced above to our Customer Support Team. A quote will be provided and your signature for approval to proceed will be required for all orders being processed.
---	---------	------------------------------------------------------------------------------------------------------------------------------------------------------------------------------------------------------------------------------------------------------------------------------------------------------------------------------------------------------------------------------------------------------------------------------------------

Continued on next page...

► For PRICING ► See Section V.3 in our current Wholesale Pricing Catalog.

Technical Notes: High Pressure Laminate Doors & Drawer Fronts

Dealer Aids (Chapter T)

1	Laminate Sample Chips	A sample set of the six colors is available. See <i>Product Samples - Section T.2</i> for more information. • Use part #186136.
----------	------------------------------	------------------------------------------------------------------------------------------------------------------------------------

Finish Options (Chapter R)

1	Colors/Finishes	Each stock color is only available in the finish that it's noted with.
----------	------------------------	------------------------------------------------------------------------

Functional Options (Chapter F)

1	Hinge Boring	Hinge boring is available for High Pressure Laminate doors & drawer fronts with a 3/4" [19.1mm] finished thickness; please contact Customer Support to inquire about hinge bore options on doors & drawer fronts with a 5/8" [15.9mm] finished thickness. Please see <i>Section F.1</i> for additional hinge boring requirements, ordering instructions and compatibility.
2	Finger Pull Moldings	Wood finger pull moldings are available. See <i>Section F.8</i> . Not all HPL Door Manufacturing options are compatible. Please see the EBT - Fingerpull Molding Compatibility chart on our website: Resources/Technical Information .

Material Options

1	Core Material	High Pressure Laminate (HPL) doors and drawer fronts will have an MDF core.
2	Edgeband Material	Matching PVC (HPL-2) <i>or</i> Laminate (HPL-4) edgebanding.
3	HPL Manufacturer	Formica (six colors kept in stock), Wilsonart, Nevamar, <i>or</i> another manufacturer of your choice.

Miscellaneous

1	Edgeband Grain Direction	Choose from either Lineal grain direction or Front to Back grain direction for each edge. Limited to HPL-4 only. Unless otherwise specified, WalzCraft's "standard" will be to apply the laminate edgebanding in a Lineal direction. Front to Back grain direction is limited to a maximum length of 48". See <i>Section B.10</i> for diagram.
----------	---------------------------------	--------------------------------------------------------------------------------------------------------------------------------------------------------------------------------------------------------------------------------------------------------------------------------------------------------------------------------------------------------------------------------------

Sizes/Dimensions

1	Thickness	Available in finished thicknesses of 5/8" (+/- .015") or 3/4" (+/- .015").
2	Minimum Size	Minimum part size is 3" x 3" [76.2mm x 76.2mm] with machine applied edgebanding. Smaller sizes may be edgebanded by hand, but additional charges may apply.

HPL Doors & Drawer Fronts - END

► For PRICING ► See Section V.3 in our current Wholesale Pricing Catalog.

Composite Material Options

High Pressure Laminate (HPL)

High Pressure Laminate (HPL) Sheet Stock

HPL Name	Brand	Color #	Thickness	Grade	Backing
Natural Ash (Woodbrush Finish)	Formica	8843-WR	.027" [0.7mm]	Vertical	Phenolic
Weathered Ash (Woodbrush Finish)	Formica	8842-WR	.027" [0.7mm]	Vertical	Phenolic
Cardboard (Sculpted Finish**)	Formica	7813-SP	.035" [0.9mm]	Post Forming	Phenolic
Possum (Micro Dot Finish)	Formica	5343-MC	.027" [0.7mm]	Vertical	Phenolic
Wheat Strand (Matte Finish)	Formica	6212-58	.035" [0.9mm]	Post Forming	Phenolic
White (Matte Finish)	Formica	949-58	.027" [0.7mm]	Vertical	Phenolic

** = Standard grain direction for Cardboard with Sculpted Finish is horizontal. 4' x 8' sheets have the grain running with the 4' width.

Ordering & Pricing Notes: High Pressure Laminate Sheet Stock

Ordering Guidelines

1	Order Forms	Please use <i>Sheet Goods Order Form (E•Z Form #8.2)</i> and part #185.
2	Ordering Information	Please provide our Customer Support Team with the below material and manufacturing options for your order or quote. <ul style="list-style-type: none"> • HPL manufacturer: Formica, Wilsonart, Nevamar, or another manufacturer of your choice. • HPL color name and number along with finish type (ex: Formica #6212-58, Wheat Strand-Matte Finish). <ul style="list-style-type: none"> ◦ If the HPL color has a pattern or grain, you will need to specify grain direction. ◦ Not available with metallic or high gloss laminate.
Pricing		
1	Pricing	See <i>Section V.3</i> of our current Wholesale Pricing Catalog for the six stock Formica colors shown. <ul style="list-style-type: none"> • For any other manufacturer, color or finish, please submit the <i>Ordering Information</i> referenced above to our Customer Support Team. A quote will be provided and your signature for approval to proceed will be required for all orders being processed.

Technical Notes: High Pressure Laminate Sheet Stock

Dealer Aids (Chapter T)

1	Laminate Sample Chips	A sample set of the six colors is available. See <i>Product Samples - Section T.2</i> for more information. <ul style="list-style-type: none"> • Use part #186136.
---	-----------------------	-----------------------------------------------------------------------------------------------------------------------------------------------------------------------------------

Finish Options (Chapter R)

1	Colors/Finishes	Each stock color is only available in the finish that it's noted with.
---	-----------------	------------------------------------------------------------------------

Sheet Stock Options (Chapter K)

1	Laminate Sheets	Laminate sheets with a non-adhesive phenolic back are available.	
		Rough Cut Stock Sizes (RCSS)	Only available in the following sizes: 4'x8', 2'x8', 4'x4', 2'x4'.
		Ripped to Rough Width (RTRW)	Available in customer specified widths x 8' long only.
		Precision Cut to Size (PCTS)	Available in customer specified widths and lengths (any size piece that the sheet will yield).
2	Custom Pressed	Custom Pressed sheet stock is available using High Pressure Laminate (HPL). <ul style="list-style-type: none"> • Please see <i>Section K.3</i> for more information. 	

HPL Sheet Stock - END

► For PRICING ► See Section V.3 in our current Wholesale Pricing Catalog.

Melamine Doors & Drawer Fronts

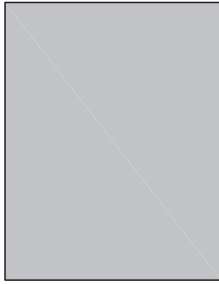

Style: 2223
 5/8" Thick PC: 650
 3/4" Thick PC: 651
 Frame PC: NA
 Min. Size: 3x3
 [76.2mm x 76.2mm]

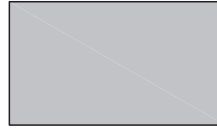

Style: 2223*
 Drawer Front
 5/8" Thick PC: 650
 3/4" Thick PC: 651
 Frame PC: NA
 Min. Size: 3x3
 [76.2mm x 76.2mm]

Melamine Door Manufacturing Option

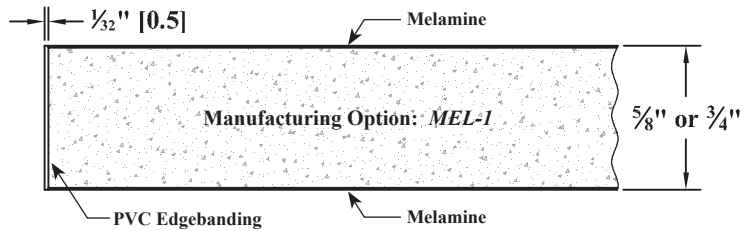

Ordering & Pricing Notes: Melamine Doors & Drawer Fronts

Ordering Guidelines

1 Order Forms Please use *Door and/or Drawer Front Order Forms (E•Z Forms #2 and #3)*.

Pricing

1 Pricing Please see *Section V.4* of our current Wholesale Pricing Catalog.

Technical Notes: Melamine Doors & Drawer Fronts

Functional Options (Chapter F)

1 Hinge Boring	Hinge boring is available for Melamine doors & drawer fronts with either a 5/8" or 3/4" finished thickness. • Please see <i>Section F.1</i> for additional hinge boring requirements, ordering instructions and compatibility.
2 Finger Pull Moldings	Wood finger pull moldings are available. See <i>Section F.8</i> . Please see the EBT - Fingerpull Molding Compatibility chart on our website: Resources/Technical Information .

General Information (Chapter A)

1 Grain Direction See *Section A.1* for standard grain direction when choosing a pattern with grain.

Material Options

1 Core Melamine doors have a particle board core.

Profile Options (Chapter E)

1 Outside Edge Only available with a square outside edge with PVC edgebanding.

Sizes/Dimensions

1 Thickness	Available in 5/8" or 3/4" nominal thicknesses. See grid on following page for exact melamine thicknesses with tolerances.
2 Minimum Size	Minimum part size is 3" x 3" [76.2mm x 76.2mm] with machine applied edgebanding. • Smaller sizes may be edgebanded by hand, but additional charges may apply.

Melamine Doors & Drawer Fronts - END

► For PRICING ► See *Section V.4* in our current Wholesale Pricing Catalog.

Melamine Sheet Stock

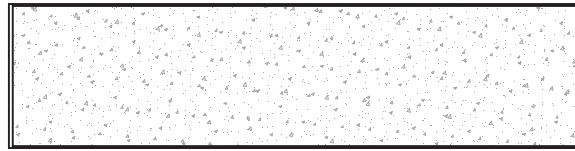

Part #185 - Melamine Availability		1/4" Melamine .236" [6.0mm] Thick +/- .015" (4' x 8')			1/2" Melamine .500" [12.7mm] Thick +/- .015" (4' x 8')			1/2" Melamine .528" [13.4mm] Thick +/- .015" (4' x 8')			5/8" Melamine .626" [15.9mm] Thick +/- .015" (4' x 8')			5/8" Melamine .658" [16.7mm] Thick +/- .015" (4' x 8')			3/4" Melamine .752" [19.1mm] Thick +/- .015" (4' x 8')			3/4" Melamine .752" [19.1mm] Thick +/- .015" (5' x 8')		
		RCSS	RTRW	PCTS	RCSS	RTRW	PCTS	RCSS	RTRW	PCTS	RCSS	RTRW	PCTS	RCSS	RTRW	PCTS	RCSS	RTRW	PCTS			
Sheet Stock Size																						
White Melamine 2S (White on Two Sides)	MDF Core	X	X	X																		
	Particle Board Core							X	X	X				X	X	X			X	X	X	
Almond Melamine 2S (Almond on Two Sides)	MDF Core	X	X	X																		
	MDF Core-NAUF	X	X	X																		
	Particle Board Core				X	X	X				X	X	X			X	X	X				
Maple Melamine 2S (Maple on Two Sides)	MDF Core	X	X	X																		
	Particle Board Core				X	X	X				X	X	X			X	X	X				
	Particle Board Core-NAUF				X	X	X															

Ordering & Pricing Notes: Melamine Sheet Stock

Ordering Guidelines

1	Order Forms	Please use <i>Sheet Goods Order Form (E•Z Form #8.2)</i> .
Pricing		
1	Pricing	Please see <i>Section V.4</i> of our current Wholesale Pricing Catalog.

Technical Notes: Melamine Sheet Stock

General Information (Chapter A)

1	Shipping	PM18 (U-Channel Box) will be WalzCraft's preferred method of packaging sheet stock 1/8" thick or greater, unless otherwise specified.
---	----------	----------------------------------------------------------------------------------------------------------------------------------------------

Material Options

1	NAUF	No Added Urea Formaldehyde.
2	TSCA Title VI	All melamine listed above is compliant with TSCA Title VI standards related to formaldehyde emissions in composite wood products.

Sheet Stock Options (Chapter K)

1	Edgebanding	Please see <i>Section L.1 - Basic Cabinet Box Components</i> for edgebanding sheet stock parts.
---	-------------	-------------------------------------------------------------------------------------------------

Sizes/Dimensions

1	4 x 8 Sheet Sizes	4'x8' panels are considered 95% "free from defect". Actual sheet size is 49" x 97".
2	RCSS - Rough Cut Stock Size	A sheet that is only available in the following sizes: 4'x8', 2'x8', 4'x4', 2'x4'.
		Edges may need to be trimmed. Some sheets may be slightly oversized. Allow 1/8" per saw kerf.
3	RTRW - Ripped to Rough Width	Available in customer specified widths x 8' long only.
		Edges may need to be trimmed. Specified widths will not be oversized. Some lengths may be slightly oversized.
		Minimum width for Melamine sheet stock is 3/4". Allow 1/8" per saw kerf.
4	PCTS - Precision Cut to Size	Available in customer specified widths and lengths (any size piece that the sheet will yield).
		No trimming of edges is needed. Pieces will not be oversized.
		Minimum width for Melamine sheet stock is 3/4". Allow 1/8" per saw kerf.

Melamine Sheet Stock - END

► For PRICING ► See Section V.4 in our current Wholesale Pricing Catalog.

PVC Edgebanding Rolls

Color	Type	Thickness	Width	Roll Length	Backing	EB Part #
White PVC	Unglued	0.5mm	7/8"	250' +/- 5%	PVC	185591
White PVC	Unglued	0.5mm	7/8"	600' +/- 5%	PVC	185220
Almond PVC	Unglued	0.5mm	15/16"	250' +/- 5%	PVC	PVCA2
Almond PVC	Unglued	0.5mm	15/16"	600' +/- 5%	PVC	PVCA6
Maple PVC	Unglued	0.5mm	7/8"	250' +/- 5%	PVC	PVCM2
Maple PVC	Unglued	0.5mm	7/8"	600' +/- 5%	PVC	PVCM6

Ordering & Pricing Notes: PVC Edgebanding

Ordering Guidelines

1	Order Forms	Please use <i>Molding & Miscellaneous Order Form (E-Z Form #5)</i> .
----------	--------------------	--------------------------------------------------------------------------

Pricing

1	Pricing	Please see <i>Section V.4</i> of our current Wholesale Pricing Catalog.
----------	----------------	-------------------------------------------------------------------------

Technical Notes: PVC Edgebanding

Finish Options (Chapter R)

1	Available Colors & Patterns	White, Almond, Maple Wood Grain. Matches our melamine doors and sheet stock.
----------	----------------------------------------	------------------------------------------------------------------------------

Material Options

1	Backing	Available unglued with a PVC backing only.
		Currently we do not offer a pre-glued PVC edgebanding that requires heat activation.

Sizes/Dimensions

1	Widths	Widths vary, but all can be trimmed and applied to doors or end panels.
----------	---------------	-------------------------------------------------------------------------

PVC Edgebanding - END

► **For PRICING** ► See *Section V.4* in our current Wholesale Pricing Catalog.