



### Chapter D Table of Contents

Section #	Section Name /Contents	Page #
D.1	Convex/Concave Products & Glossary of Terms	<a href="#">D.1.2</a>
	◦ Convex	<a href="#">D.1.2</a>
	◦ Concave	<a href="#">D.1.2</a>
	◦ Chord	<a href="#">D.1.2</a>
	◦ Radius & Diameter	<a href="#">D.1.3</a>
	◦ Circumference & Arc	<a href="#">D.1.3</a>
	◦ Rise	<a href="#">D.1.3</a>
D.2	Convex Ordering Information	<a href="#">D.2.1</a>
	◦ Convex Face Frame Only	<a href="#">D.2.1</a>
	◦ Convex Face Frame w/ Overlay Door	<a href="#">D.2.1</a>
	◦ Convex Face Frame w/ Inset Door	<a href="#">D.2.2</a>
	◦ Convex Pair of Doors	<a href="#">D.2.2</a>
	◦ Convex Crown Molding	<a href="#">D.2.2</a>
D.3	Concave Ordering Information	<a href="#">D.3.1</a>
	◦ Concave Face Frame Only	<a href="#">D.3.1</a>
	◦ Concave Face Frame w/ Overlay Door	<a href="#">D.3.1</a>
	◦ Concave Face Frame w/ Inset Door	<a href="#">D.3.2</a>
	◦ Concave Pair of Doors	<a href="#">D.3.2</a>
	◦ Concave Crown Molding	<a href="#">D.3.2</a>
D.4	Convex/Concave Crown Molding Profile Options	<a href="#">D.4.1</a>
D.5	Convex/Concave General Information	<a href="#">D.5.1</a>

**D**

*Curved Products - Convex/Concave*

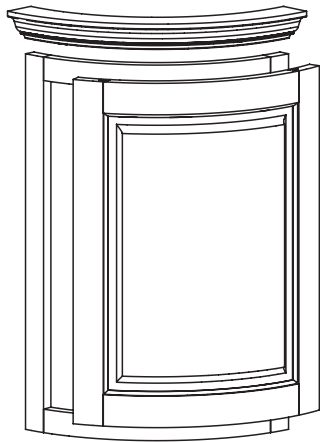

**Convex**  
*Raised Panel Door, Face Frame  
 and Crown Molding Shown*

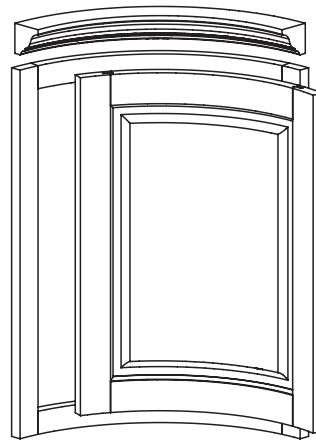

**Concave**  
*Raised Panel Door, Face Frame  
 and Crown Molding Shown*

**C** = This symbol is used throughout the catalog to represent products and profiles that are available Convex/Concave.  
 • See individual chapters and/or sections for more information.

**Glossary of Curved Product Terms**

**Convex**

**Convex:** Curving outwards like the outside of a circle.  
 • The chord length of a Convex product would be measured at the back.



**Face (Convex)**

**Concave**

**Concave:** Curving inwards like the inside of a circle.  
 • The chord length of a Concave product would be measured at the front.



**Face (Concave)**

**Chord**

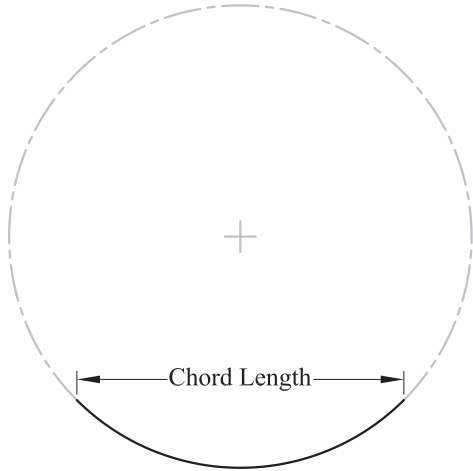

**Chord:** A straight line joining two points on a curve.

- **Convex:** Measured at the back of a product.
- **Concave:** Measured at the face of a product

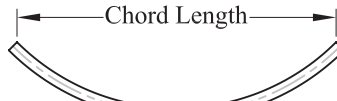

**Face (Convex)**



**Face (Concave)**

*Continued on next page...*

► **For PRICING** ► See Section **D.1** in our current Wholesale Pricing Catalog.



Glossary of Curved Product Terms...continued

Radius & Diameter

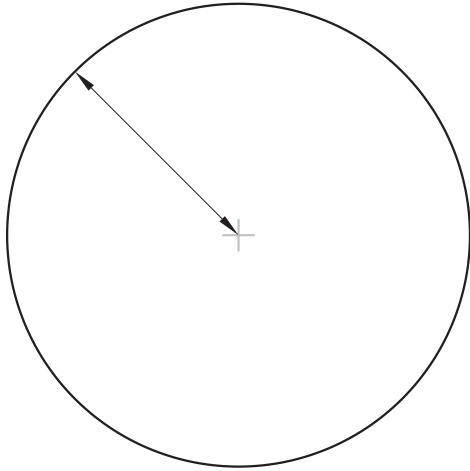

**Radius:** A straight line drawn from the center of a circle to any point on its circumference.

- Standard radii apply, see Section D.4.

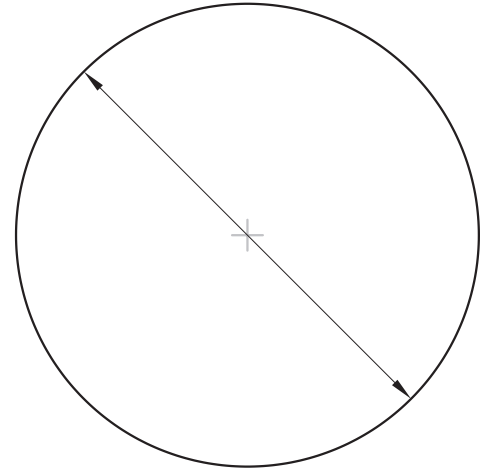

**Diameter:** A straight line passing through the center of a circle, ending at the boundary of the figure.

- The diameter is also the chord length for a half circle.

D

Circumference & Arc

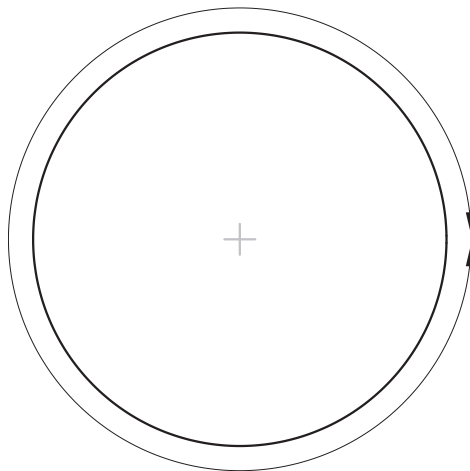

**Circumference:** The line bounding a circle, or its length.

- Curved products are a part of a circle.

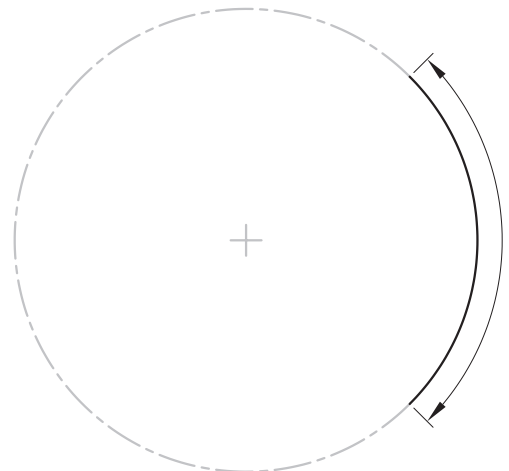

**Arc:** Part of the circumference of a circle or part of any other curve.

- The arc length is used as the width when calculating square footage for Curved products.

Rise

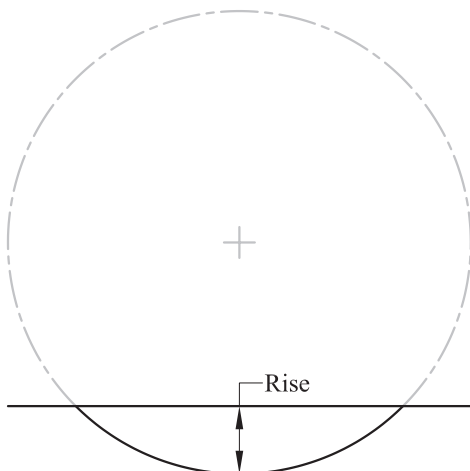

**Rise:** A change in vertical position measured from the center of the chord.

- The rise may be specified. If the rise falls into a custom radius application, a modification may be required to accommodate standard tooling requirements.

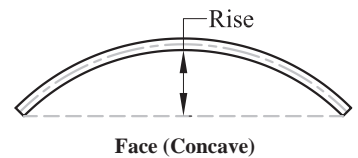
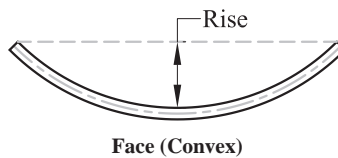

Glossary of Curved Product Terms - END

► For PRICING ► See Section D.1 in our current Wholesale Pricing Catalog.

D

## Convex Face Frame Only

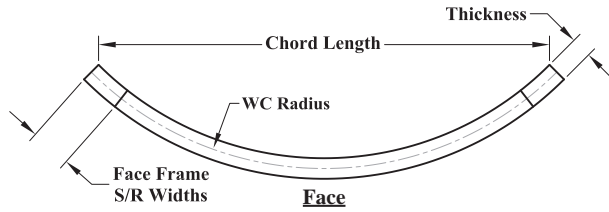

### Required Ordering Information

- Radius
- Chord Length
- Face Frame Thickness
- Overall Face Frame Height
- Opening Height(s)
- Stile and Rail Widths
- Face Frame Configuration (ex: **FF100**, **FF101**)
- Face Frame Stock Profile (ex: **FS100**, **FS101**)

**Note:** All radii are calculated to the center of a 3/4" [19.1mm] thick door (or face frame when ordering a face frame only). Convex products greater than 3/4" [19.1mm] thick will have radii calculated 3/8" [9.5mm] in from the face.

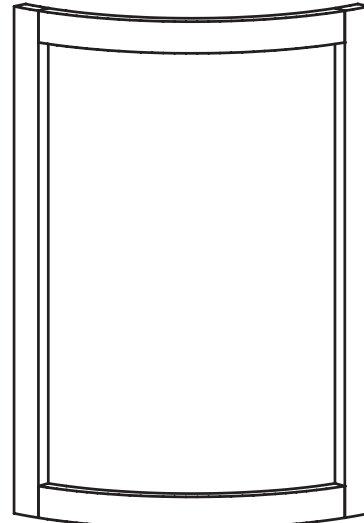

FF100 w/ FS100 Shown

## Convex Face Frame w/ Overlay Door

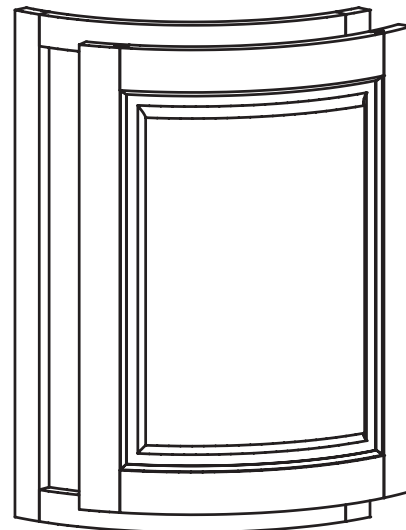
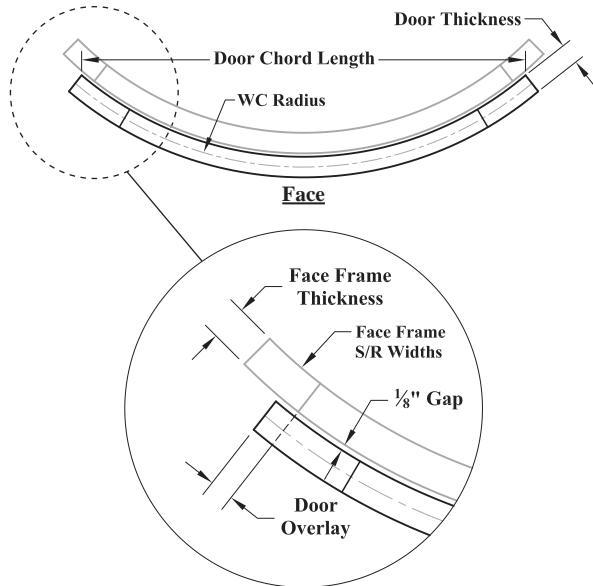

FF100 w/ FS100 & Style 10 Door Shown

### Required Ordering Information

- Door Radius
- Door Chord Length
- Door Thickness
- Door Height
- Door Overlay
- Door Style & Profiles
- Face Frame Thickness
- Face Frame Height
- Face Frame Opening Height(s)
- Face Frame Stile and Rail Widths
- Face Frame Configuration (ex: **FF100**, **FF101**)
- Face Frame Stock Profile (ex: **FS100**, **FS101**)

**Note:** All radii are calculated to the center of a 3/4" [19.1mm] thick door. Convex products greater than 3/4" [19.1mm] thick will have radii calculated 3/8" [9.5mm] in from the face.

Continued on Next Page...

► For PRICING ► See Section D.1 in our current Wholesale Pricing Catalog.

Convex Face Frame w/ Inset Door

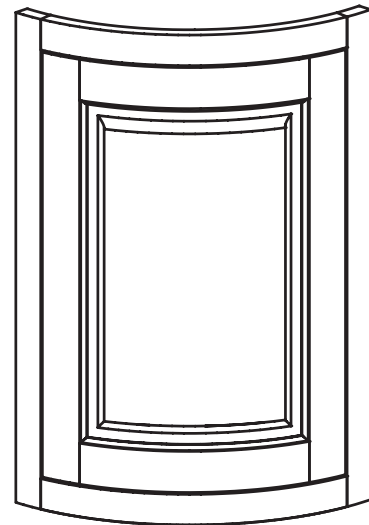
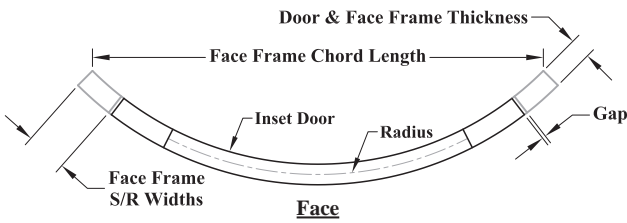

FF100 w/ FS100 & Style 10 Door Shown

**Required Ordering Information**

- Door/Face Frame Radius
- Door/Face Frame Thickness
- Face Frame Opening Height(s)
- Gap Between Face Frame and Door
- Face Frame Configuration (ex: **FF100**, **FF101**)
- Face Frame Stock Profile (ex: **FS100**, **FS101**)
- Face Frame Chord Length
- Overall Face Frame Height
- Face Frame Stile & Rail Widths
- Door Style & Profiles

**Note:** Door will be sized by WalzCraft based on your chosen gap dimension.

**Note:** All radii are calculated to the center of a 3/4" [19.1mm] thick door. Convex products greater than 3/4" [19.1mm] thick will have radii calculated 3/8" [9.5mm] in from the face.

Convex Pair of Doors

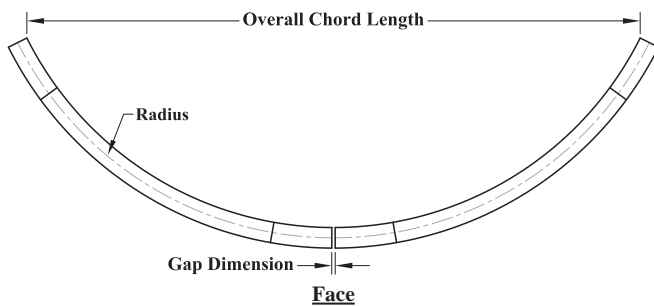

**Required Ordering Information**

- Door Radius
- Door Thickness
- Gap Between Doors
- Overall Chord Length
- Overall Door Height
- Door Style & Profiles

**Note:** All radii are calculated to the center of a 3/4" [19.1mm] thick door. Convex products greater than 3/4" [19.1mm] thick will have radii calculated 3/8" [9.5mm] in from the face.

Convex Crown Molding



Crown Molding #2179 Shown

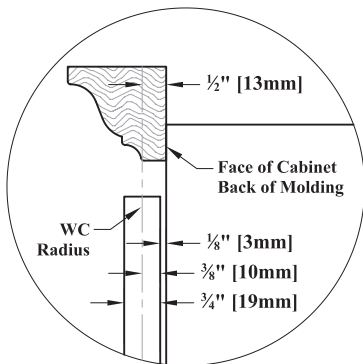
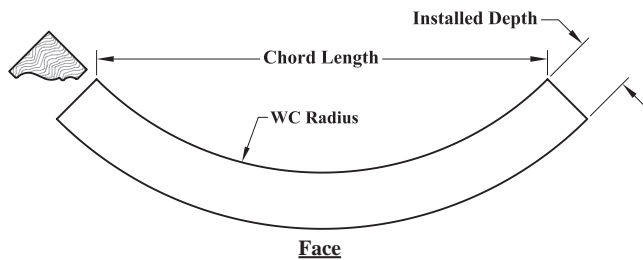

**Required Ordering Information**

**Crown Molding Only:** When ordering convex crown molding only (no door or face frame), please provide the radius at the back of the molding as well as the overall chord length.

**Crown Molding with Door/Face Frame:** When ordering convex crown molding with a door and/or face frame, WalzCraft will calculate the molding's radius based off of the door and/or face frame.

**Note:** This calculation will assume the crown molding will be attached to the face of the face frame and that there will be 1/8" [3.2mm] gap between the door and face frame.

Convex Ordering Information - END

► For PRICING ► See Section D.1 in our current Wholesale Pricing Catalog.

D

**Concave Face Frame Only**

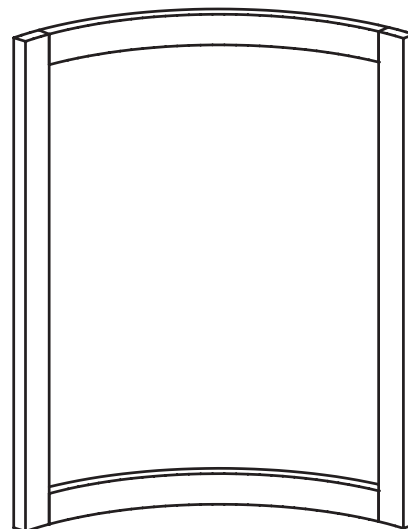
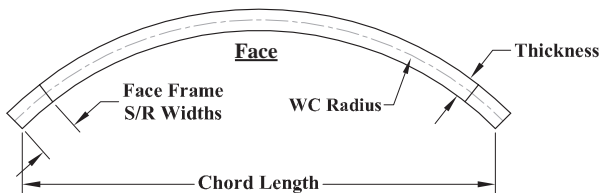

*FF100 w/ FS100 Shown*

**Required Ordering Information**

- Radius
- Chord Length
- Face Frame Thickness
- Overall Face Frame Height
- Opening Height(s)
- Stile and Rail Widths
- Face Frame Configuration (ex: **FF100**, **FF101**)
- Face Frame Stock Profile (ex: **FS100**, **FS101**)

**Note:** All radii are calculated to the center of a 3/4" [19.1mm] thick door (or face frame when ordering a face frame only). Concave products greater than 3/4" [19.1mm] thick will have radii calculated 3/8" [9.5mm] in from the back.

**Concave Face Frame w/ Overlay Door**

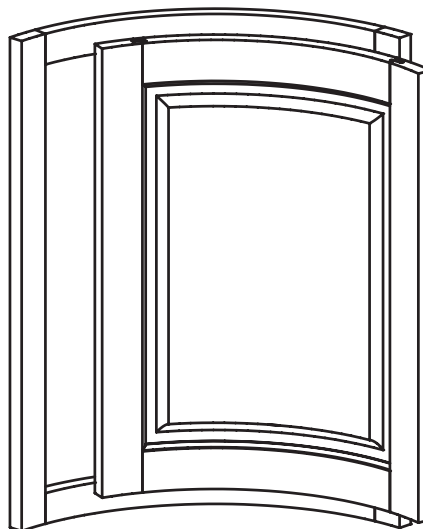
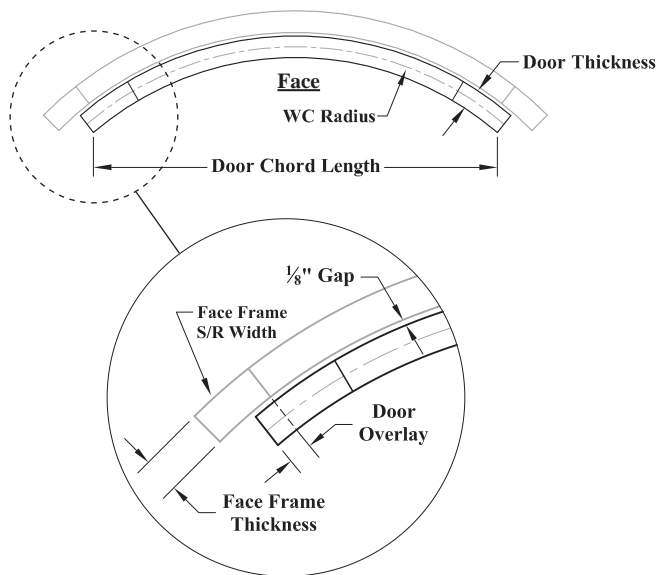

*FF100 w/ FS100 & Style 10 Door Shown*

**Required Ordering Information**

- Door Radius
- Door Chord Length
- Door Thickness
- Door Height
- Door Overlay
- Door Style & Profiles
- Face Frame Thickness
- Face Frame Height
- Face Frame Opening Height(s)
- Face Frame Stile and Rail Widths
- Face Frame Configuration (ex: **FF100**, **FF101**)
- Face Frame Stock Profile (ex: **FS100**, **FS101**)

**Note:** All radii are calculated to the center of a 3/4" [19.1mm] thick door. Concave products greater than 3/4" [19.1mm] thick will have radii calculated 3/8" [9.5mm] in from the back.

*Continued on Next Page...*

► **For PRICING** ► See Section D.1 in our current Wholesale Pricing Catalog.

Concave Face Frame w/ Inset Door

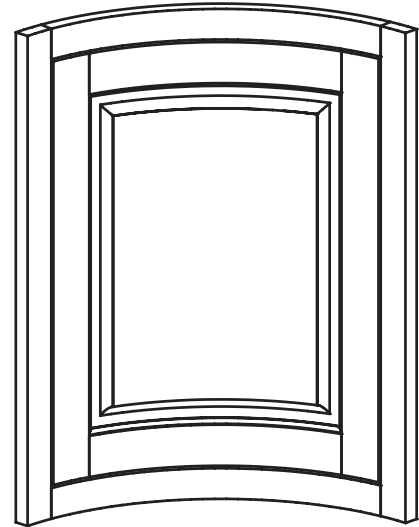
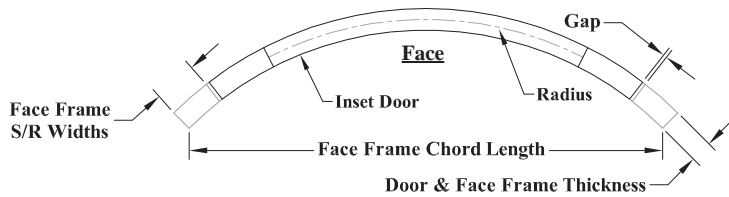

FF100 w/ FS100 & Style 10 Door Shown

**Required Ordering Information**

- Door/Face Frame Radius
- Door/Face Frame Thickness
- Face Frame Opening Height(s)
- Gap Between Face Frame and Door
- Face Frame Configuration (ex: **FF100**, **FF101**)
- Face Frame Stock Profile (ex: **FS100**, **FS101**)
- Face Frame Chord Length
- Overall Face Frame Height
- Face Frame Stile & Rail Widths
- Door Style & Profiles

**Note:** Door will be sized by WalzCraft based on your chosen gap dimension.

**Note:** All radii are calculated to the center of a 3/4" [19.1mm] thick door. Concave products greater than 3/4" [19.1mm] thick will have radii calculated 3/8" [9.5mm] in from the back.

Concave Pair of Doors

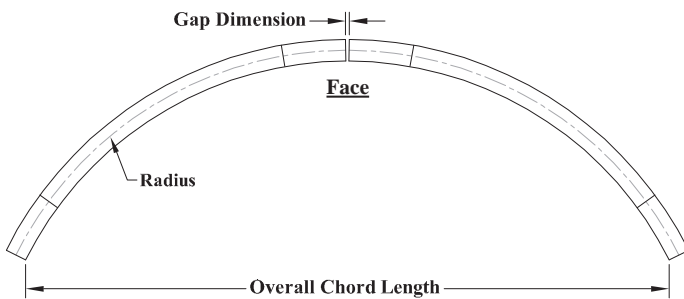

**Required Ordering Information**

- Door Radius
- Door Thickness
- Gap Between Doors
- Overall Chord Length
- Overall Door Height
- Door Style & Profiles

**Note:** All radii are calculated to the center of a 3/4" [19.1mm] thick door. Concave products greater than 3/4" [19.1mm] thick will have radii calculated 3/8" [9.5mm] in from the back.

Concave Crown Molding



Crown Molding #2179 Shown

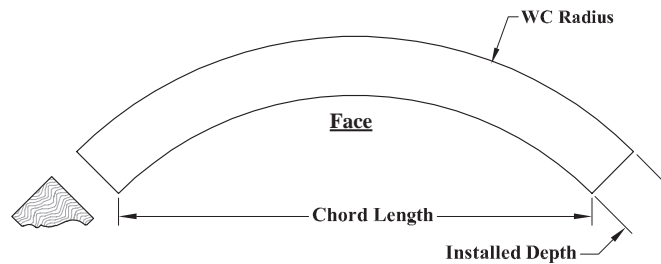
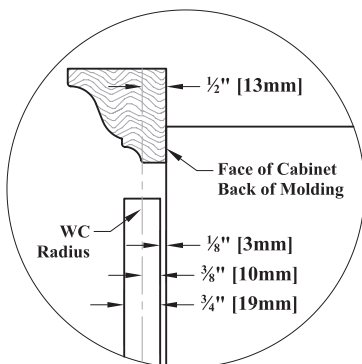

**Required Ordering Information**

**Crown Molding Only:** When ordering concave crown molding only (no door or face frame), please provide the radius at the back of the molding as well as the overall chord length.

**Crown Molding with Door/Face Frame:** When ordering concave crown molding with a door and/or face frame, WalzCraft will calculate the molding's radius based off of the door and/or face frame.

**Note:** this calculation will assume the crown molding will be attached to the face of the face frame and that there will be 1/8" [3.2mm] gap between the door and face frame.

Concave Ordering Information - END

► For PRICING ► See Section D.1 in our current Wholesale Pricing Catalog.

**D**

**Convex Crown Molding Application**

*Not drawn to Full Scale*

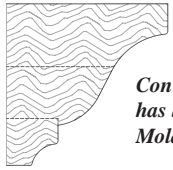
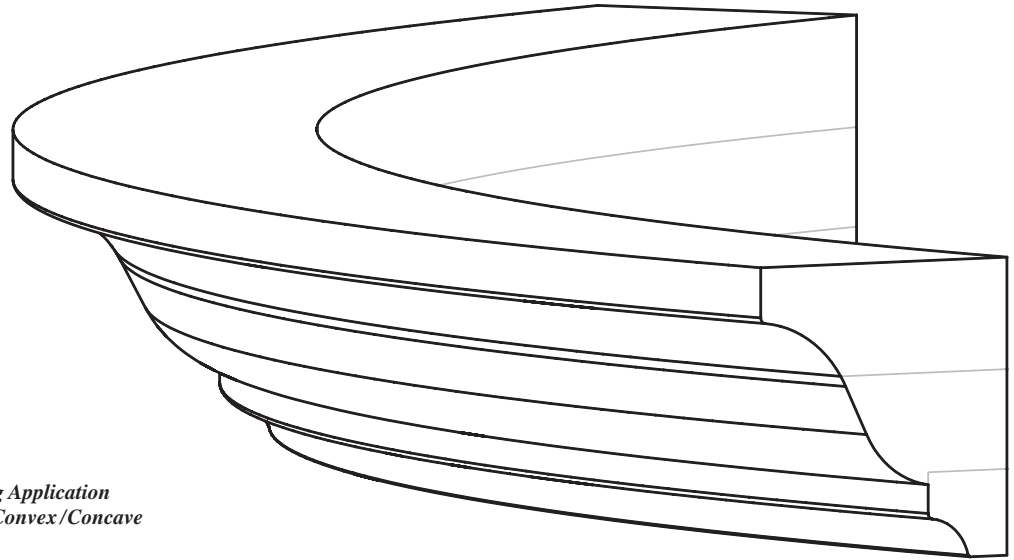

*Convex Crown Molding Application  
has been drawn using Convex/Concave  
Molding #3181.*

**Concave Crown Molding Application**

*Not drawn to Full Scale*

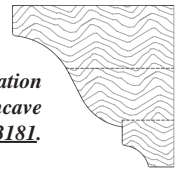
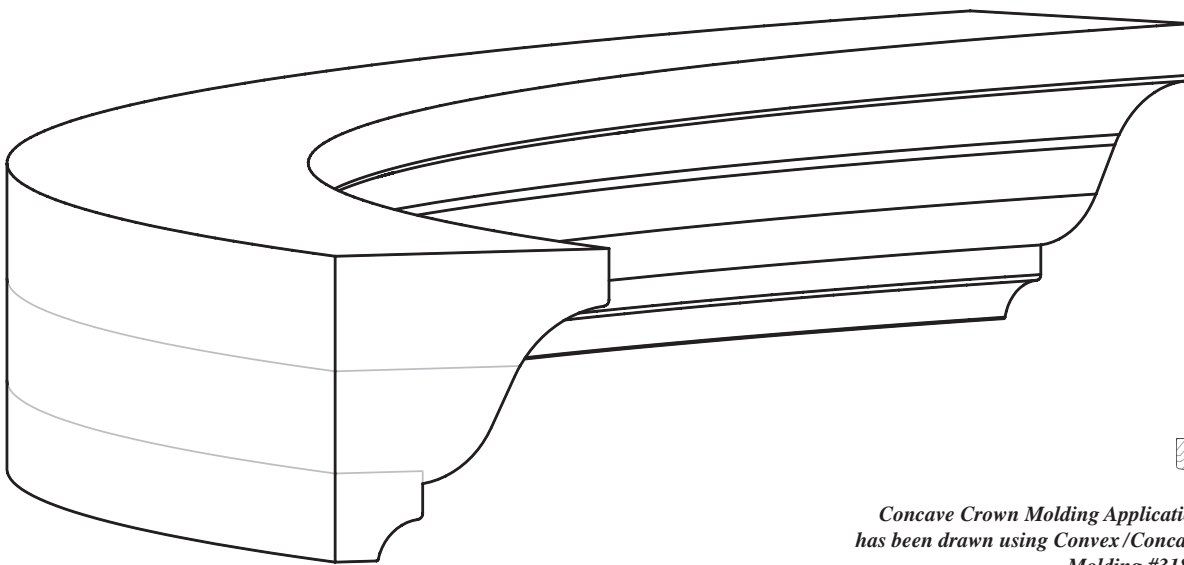

*Concave Crown Molding Application  
has been drawn using Convex/Concave  
Molding #3181.*

**\*\* For Arched Canopy Crown Molding Options, Please see Section N.10 \*\***

**► For PRICING ► See Section D.1** in our current Wholesale Pricing Catalog.



Convex/Concave Molding with Matching Crown Molding (#119)

Crown Molding

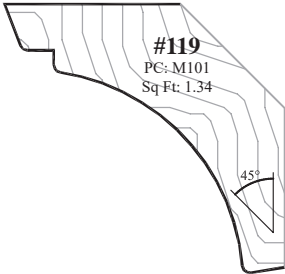

Straight Crown Block Molding

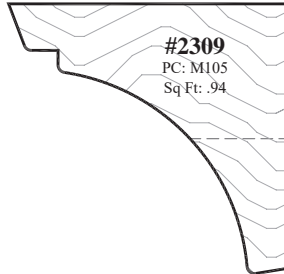

Convex/Concave Molding

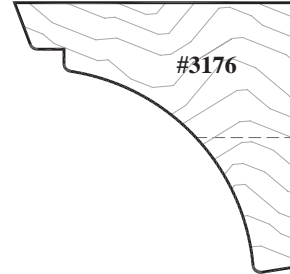

D

Convex/Concave Molding with Matching Crown Molding (#383)

Crown Molding

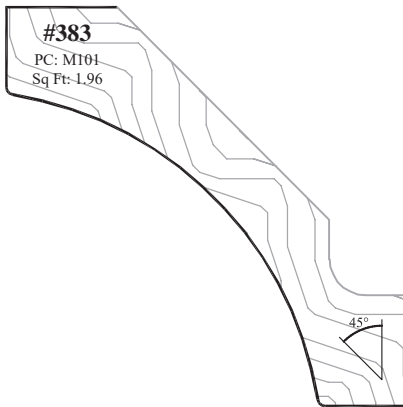

Straight Crown Block Molding

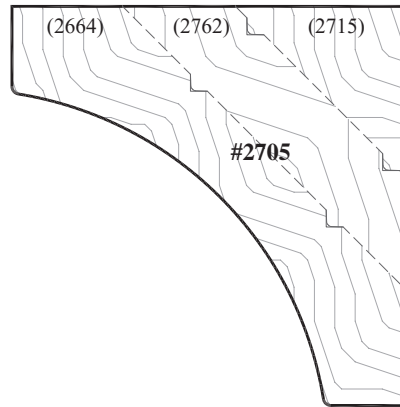

**#2705**  
PC: M101 + 2 Assembly Fees  
+ Post Assembly Machining Charge  
Sq Ft: 4.29  
Price Class applies to  
straight stock molding only  
Three pieces, assembled  
by WalzCraft.

Convex/Concave Molding

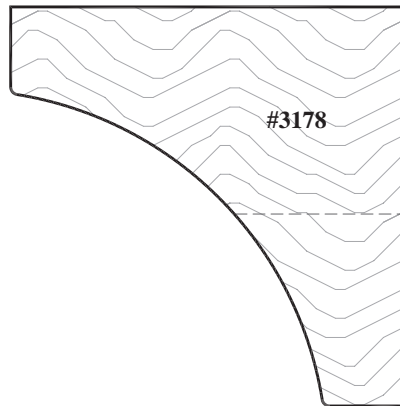

\*\* For Arched Canopy Crown Molding Options, Please see Section N.10 \*\*

► For PRICING ► See Section D.1 in our current Wholesale Pricing Catalog.

**Convex/Concave Molding with Matching Crown Molding (#208)**

**D**

**Crown Molding**

**#208**  
PC: M101  
Sq Ft: 3.33

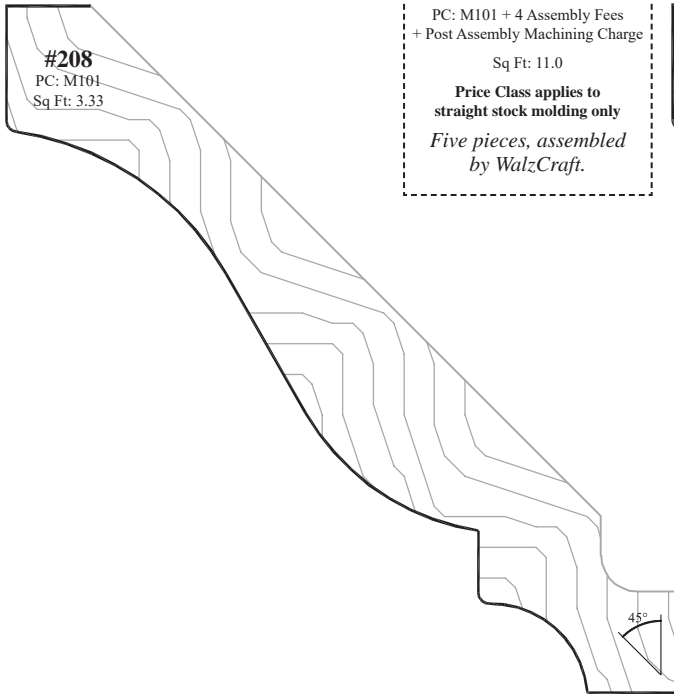

**#2861**  
PC: M101 + 4 Assembly Fees  
+ Post Assembly Machining Charge  
Sq Ft: 11.0  
Price Class applies to  
straight stock molding only  
Five pieces, assembled  
by WalzCraft.

**Straight Crown Block Molding**

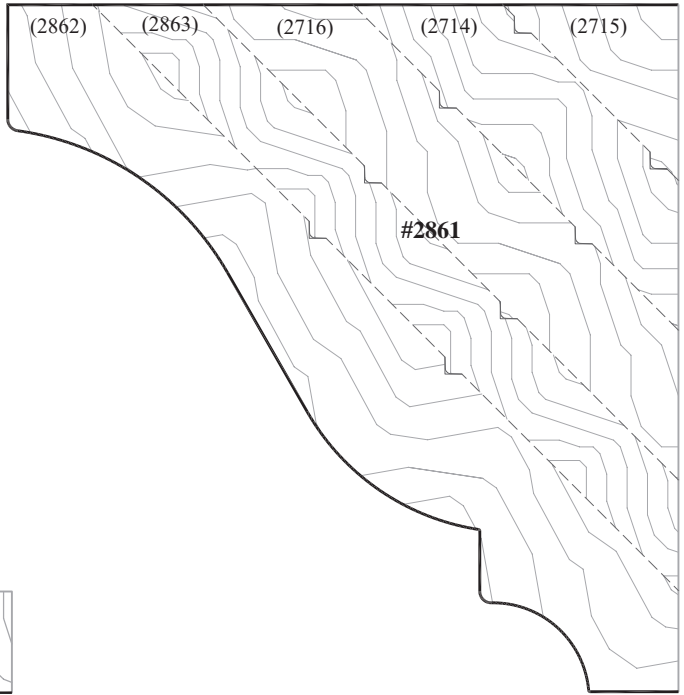

**Convex/Concave Molding**

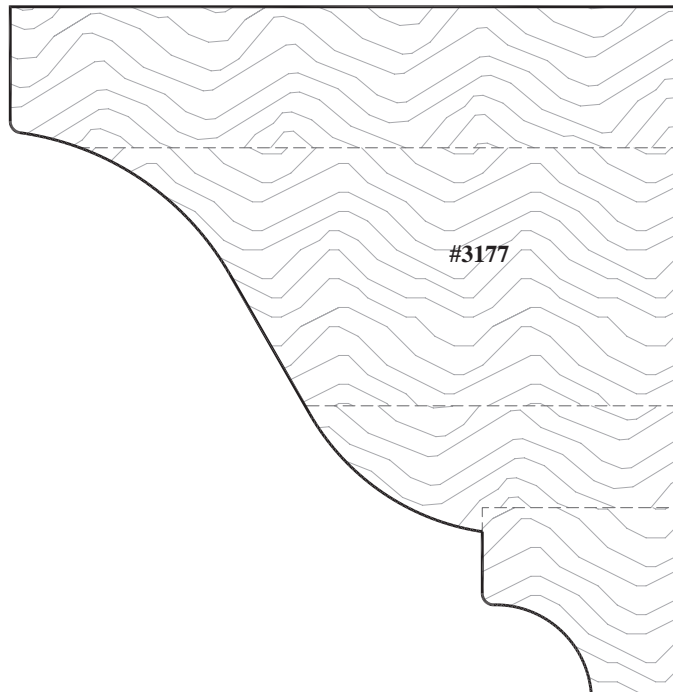

► **For PRICING** ► See Section **D.1** in our current Wholesale Pricing Catalog.



Convex/Concave Molding with Matching Crown Molding (#942)

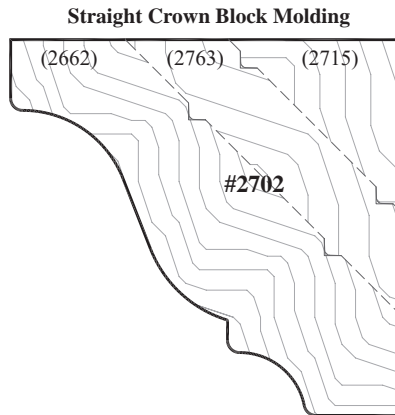
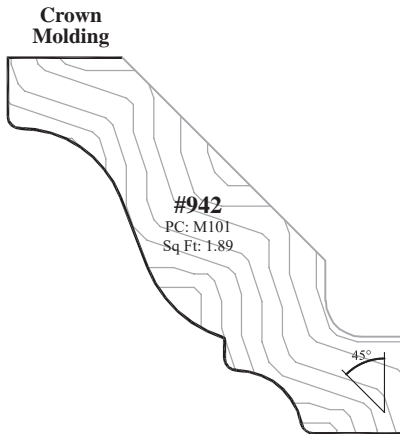

**#2702**  
 PC: M101 + 2 Assembly Fees  
 + Post Assembly Machining Charge  
 Sq Ft: 4.12  
**Price Class applies to  
 straight stock molding only**  
*Three pieces, assembled  
 by WalzCraft.*

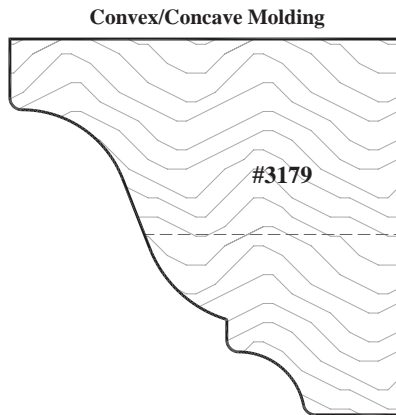

D

► For PRICING ► See Section D.1 in our current Wholesale Pricing Catalog.

**Convex/Concave Molding with Matching Crown Molding (#983)**

**D**

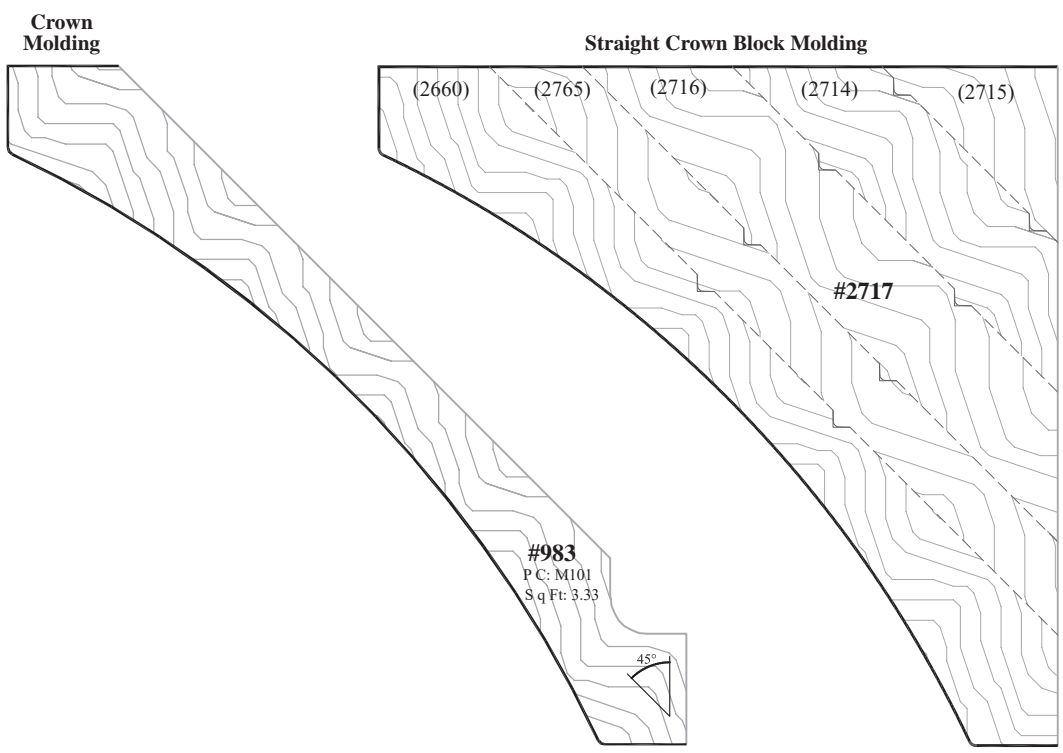

**#2717**  
 PC: M101 + 4 Assembly Fees  
 + Post Assembly Machining Charge  
 Sq Ft: 10.92  
**Price Class applies to  
 straight stock molding only**  
*Five pieces, assembled  
 by WalzCraft.*

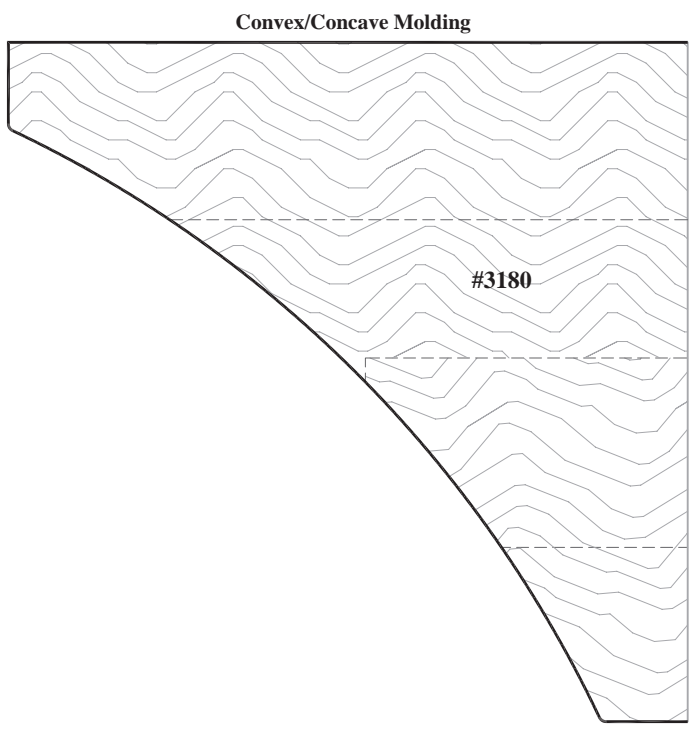

► **For PRICING** ► See Section **D.1** in our current Wholesale Pricing Catalog.

Convex/Concave Molding with Matching Crown Molding (#1160)

Crown Molding

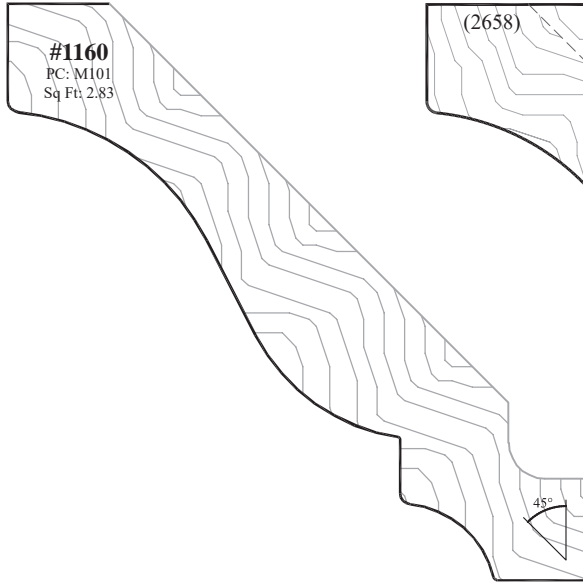

Straight Crown Block Molding

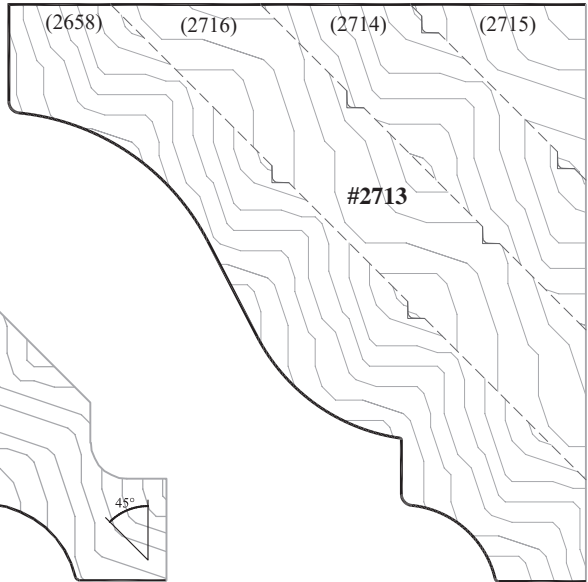

#2713  
PC: M101 + 3 Assembly Fees  
+ Post Assembly Machining Charge  
Sq Ft: 7.63  
Price Class applies to  
straight stock molding only  
Four pieces, assembled  
by WalzCraft.

Convex/Concave Molding

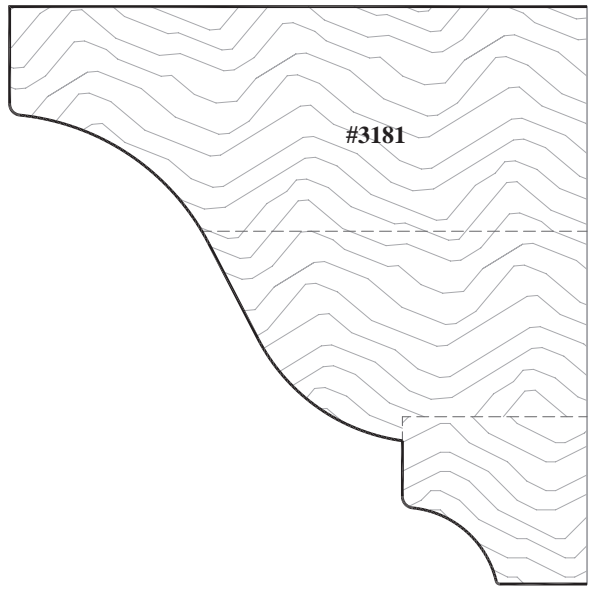

D

► For PRICING ► See Section D.1 in our current Wholesale Pricing Catalog.

Convex/Concave Molding with Matching Crown Molding (#1183)

D

Crown Molding

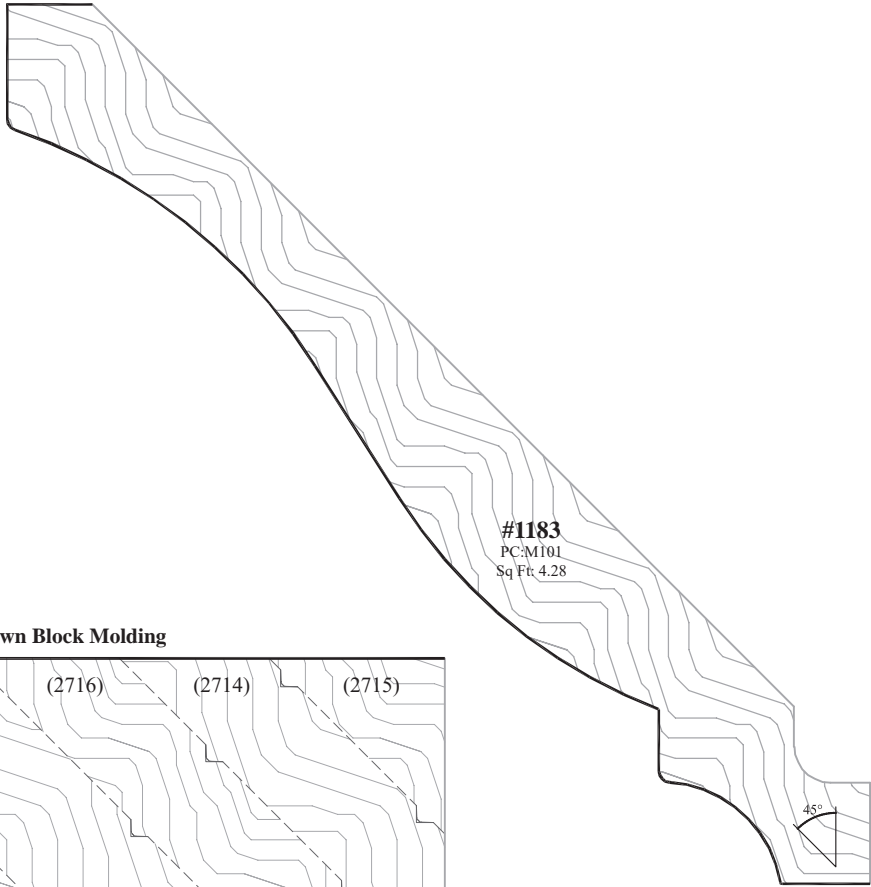

Straight Crown Block Molding



**#3182**  
 PC: M101 + 5 Assembly Fees  
 + Post Assembly Machining Charge  
 Sq Ft: 16.11  
 Price Class applies to  
 straight stock molding only  
 Four pieces, assembled  
 by WalzCraft.

Molding Continued on Next Page

► For PRICING ► See Section D.1 in our current Wholesale Pricing Catalog.



Convex/Concave Molding with Matching Crown Molding (#1183)...continued

Convex/Concave Molding



D

Convex/Concave Molding with Matching Crown Molding (#1358)

Crown Molding

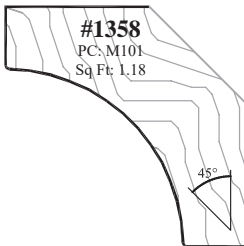

Straight Crown Block Molding

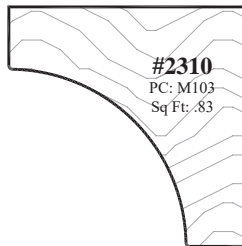

Convex/Concave Molding

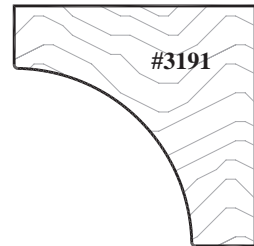

► For PRICING ► See Section D.1 in our current Wholesale Pricing Catalog.

*Convex/Concave Molding with Matching Crown Molding (#1860)*

**D**

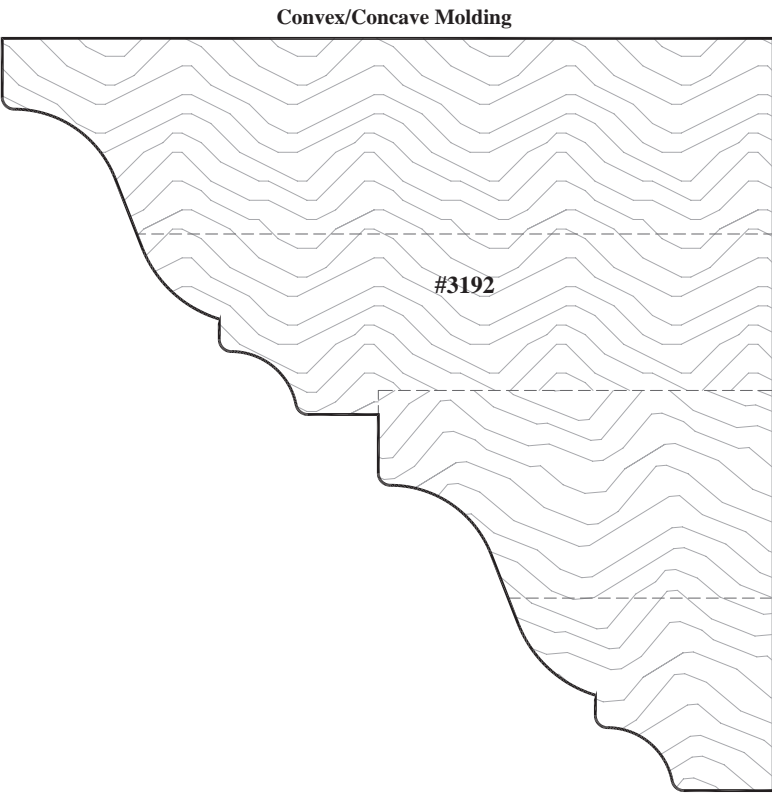
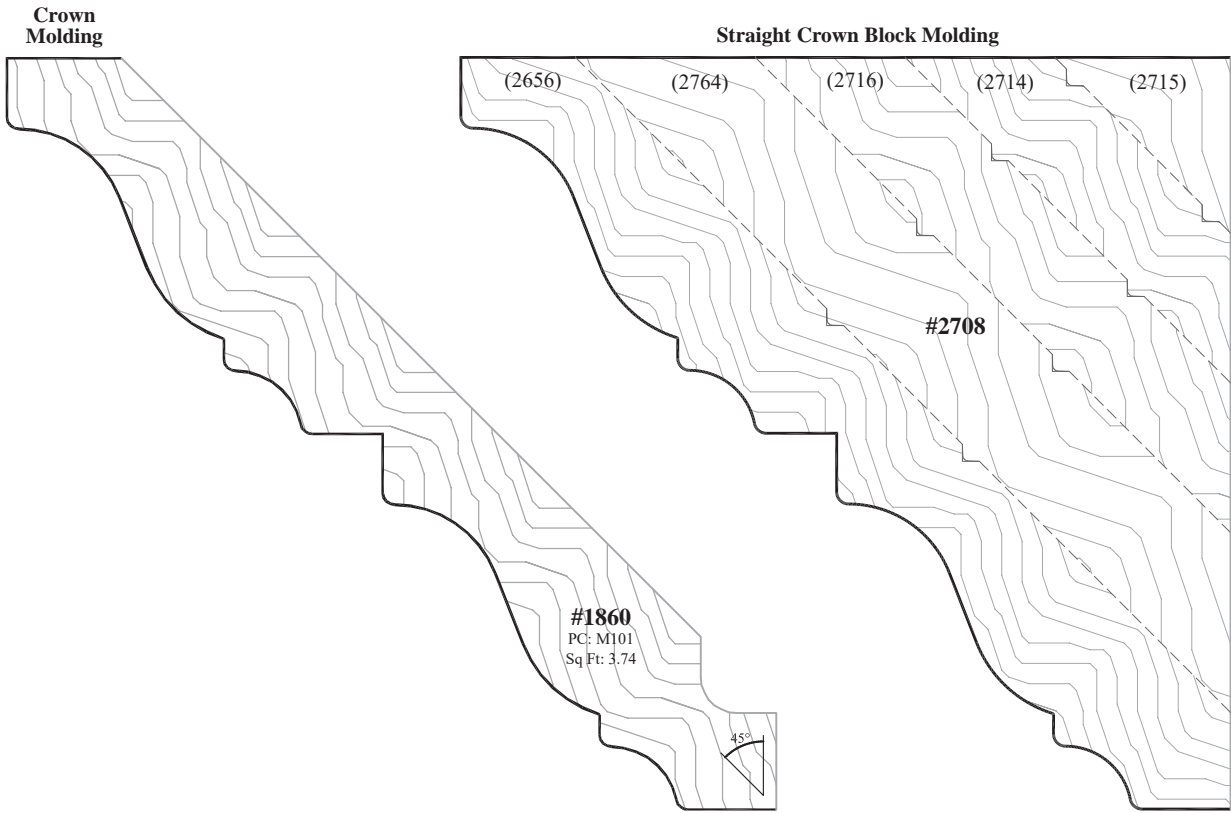

**#2708**  
PC: M101 + 4 Assembly Fees  
+ Post Assembly Machining Charge  
Sq Ft: 11.75  
Price Class applies to  
straight stock molding only  
*Five pieces, assembled  
by WalzCraft.*

► **For PRICING** ► See Section *D.1* in our current Wholesale Pricing Catalog.

Convex/Concave Molding with Matching Crown Molding (#2253)

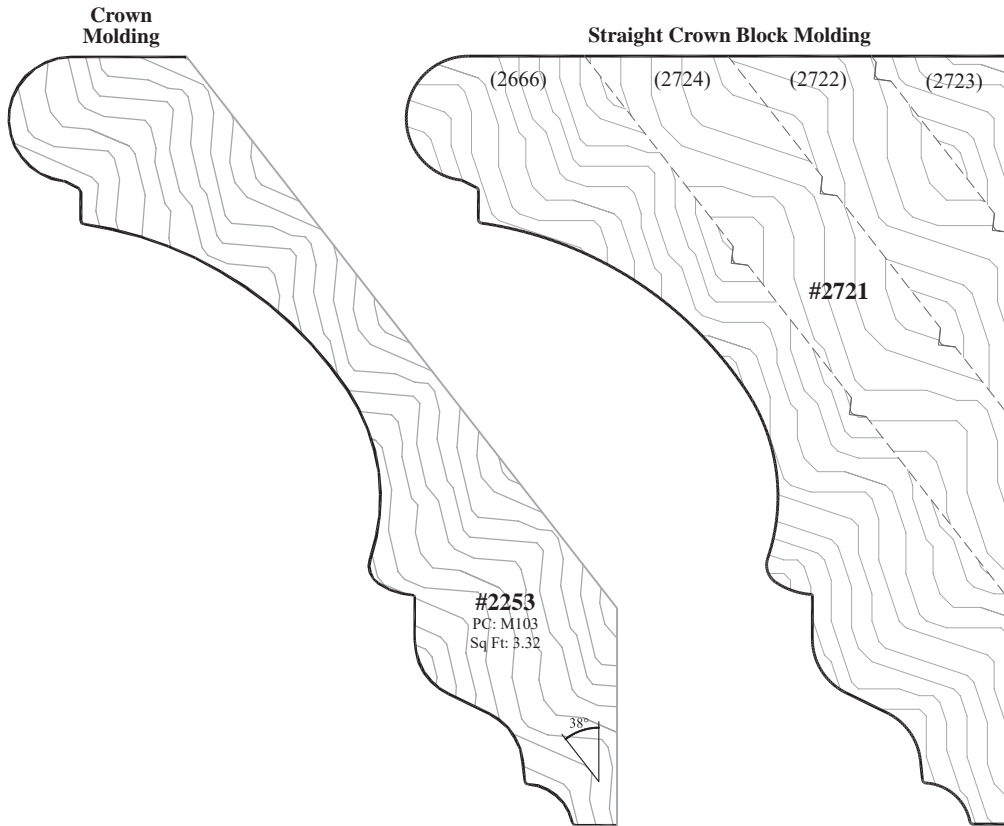

#2253  
PC: M103  
Sq Ft: 3.32

38°

#2721

**#2721**  
PC: M103 + 3 Assembly Fees  
+ Post Assembly Machining Charge  
Sq Ft: 8.17  
Price Class applies to  
straight stock molding only  
*Four pieces, assembled  
by WalzCraft.*

Convex/Concave Molding

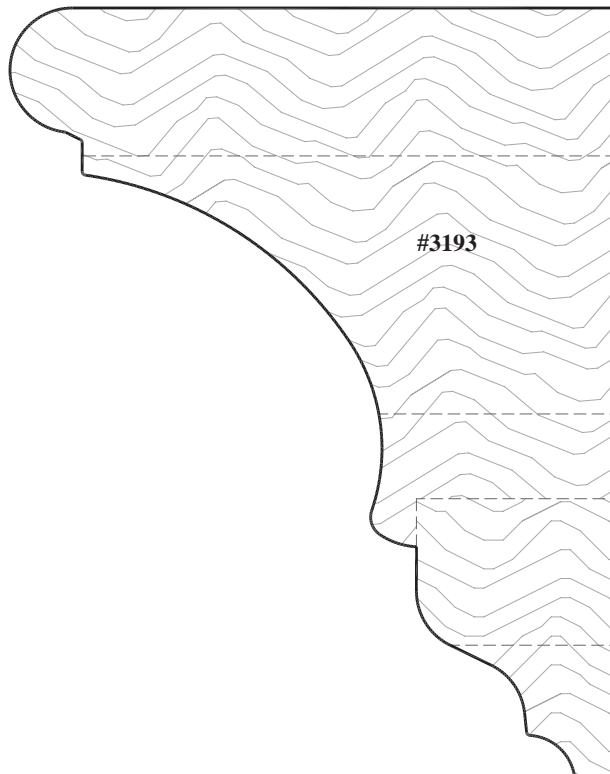

#3193

► For PRICING ► See Section D.1 in our current Wholesale Pricing Catalog.

D

## Convex/Concave Options

## Convex/Concave Crown Molding Profile Options

### Convex/Concave Molding with Matching Crown and Arched Canopy Molding

Crown Molding	Straight Crown Block Molding	Convex/Concave Molding	Arched Canopy Molding
119	2309	3176	3175
208	2861	3177	2864
383	2705	3178	2184
942	2702	3179	2179
983	2717	3180	2182
1160	2713	3181	2292
1183	3182	3189	3188
1358	2310	3191	3190
1860	2708	3192	2175
2253	2721	3193	2262

### Ordering & Pricing Notes: Convex/Concave Molding

#### Ordering Guidelines

1	Order Forms	Please use <i>Curved Molding Order Form (E•Z Form #11.3)</i> .
2	Ordering Information	When ordering, please provide: <ul style="list-style-type: none"> <li>• Molding cord length.</li> <li>• Molding radius.</li> </ul>
<b>Pricing</b>		
1	Pricing	Please see <i>Section D.1</i> of our current <b>Wholesale Pricing Catalog</b> . A quote will be submitted to you for your approval prior to proceeding with your order.

**\*\* For Arched Canopy Crown Molding Options, Please see Section N.10 \*\***

► **For PRICING** ► See *Section D.1* in our current Wholesale Pricing Catalog.





## Convex/Concave Product Radii

WalzCraft offers all of the sizes listed below as standard radii for Traditional, Mitered, Raw MDF Style 500 and Veneered Style 60 Curved Products.

- All Radii are based on 3/4" [19.1mm] thick doors.
- All Radii are calculated to the center of a 3/4" [19.1mm] thick door.
- (\*) indicates the only radius options available for **Door Styles 20, 30, 2000, 2020, 2500, 2525, 3000, 3030, 3500, 3535, 4000, 5000.**
  - These door styles also have a maximum rail width of 23".
- (\*\*) *See Notes - Sizes/Dimensions*
- Please refer to **Sections E.9 - E.II** for Mitered/French Mitered Profile options available on Curved Products.
  - **[C]** = Profile available on Curved doors. **[FM]** = Profile available on French Miter doors.
  - Door styles **10FM** and **10FM\*** are only available in radii 12" and greater.

D

Standard Radii (Inches)	Standard Radii [Millimeters]	Maximum Chord Length	Minimum Chord Length
6 (Slab Only)	152.4 (Slab Only)	<i>Half Circle</i>	<i>Evaluated On Per Order Basis</i>
9	228.6		
11 5/8 (12" to Face)**	295.3		
12 *	304.8		
12 1/2 (12" to Face)**	317.5		
15	381.0		
18 *	457.2		
21	533.4		

Standard Radii (Inches)	Standard Radii [Millimeters]	Maximum Chord Length	Minimum Chord Length
23 5/8 (24" to Face)**	600.0	<i>Quarter Circle</i>	<i>Evaluated On Per Order Basis</i>
24 *	609.6		
24 1/2 (24" to Face)**	622.3		
27	685.8		
30	762.0		
33	838.2		
36	914.4		
39	990.6		
42	1066.8		
45	1143.0		
48	1219.2		
51	1295.4		
54	1371.6		
57	1447.8		
60	1525.0		
63	1600.2		
66	1676.4		
69	1752.6		
72	1828.8		
75	1905.0		
78	1981.2		
81	2057.4		
84	2133.6		
87	2209.8		
90	2286.0		
93	2362.2		
96	2438.4		
108	2743.2		
120	3048.0		

Standard Radii (Inches)	Standard Radii [Millimeters]	Maximum Chord Length	Minimum Chord Length
132	3352.8	<i>14 Feet</i>	<i>Evaluated On Per Order Basis</i>
144	3657.6		
156	3962.4		
168	4267.2		
180	4572.0		
192	4876.8		
204	5181.6		
216	5486.4		
228	5791.2		
252	6400.8		
276	7010.4		
300	7620.0		
324	8229.6		
348	8839.2		
372	9448.8		
396	10058.4		
420	10668.0		
444	11277.6		
468	11887.2		
492	12496.8		
516	13106.4		

Ordering & Pricing Notes: Convex/Concave Products

Ordering Guidelines

1	Order Forms	Please use one of the following order forms where applicable: <ul style="list-style-type: none"> <li>• <i>Curved Door Order Form (E•Z Form #11).</i></li> <li>• <i>Curved Drawer Front Order Form (E•Z Form #11.1)</i></li> <li>• <i>Assembled Curved Face Frame Order Form (E•Z Form #11.2).</i></li> <li>• <i>Curved Molding Order Form (E•Z Form #11.3).</i></li> </ul>
2	Gap Dimension	The following information must be noted when placing an order for curved products: <ul style="list-style-type: none"> <li>• The gap dimension between a pair of doors for Convex or Concave overlay.</li> <li>• The gap dimension between a door and face frame for Convex or Concave inset.</li> </ul>
<b>Pricing</b>		
1	Pricing	Please see <i>Section D.1</i> of our current Wholesale Pricing Catalog.

Technical Notes: Convex/Concave Products...continued

Cabinet Door & Drawer Front Options (Chapter B)...continued

1	Traditional Mortise & Tenon Construction	<p><b>Raised Panel</b></p> <ul style="list-style-type: none"> <li>• Vertical grain only.</li> <li>• Door Styles <b>10, 10*, 1000, 1010, 1010*, 1941, 2271, 2272, 2291L, 2291R, 8000, 8020, 8030, 8045, 8050.</b> <ul style="list-style-type: none"> <li>◦ Available in all standard radii 9" [228.6mm] or greater.</li> <li>◦ Available as a frame only or with a mullion lite pattern.                             <ul style="list-style-type: none"> <li>▪ Available lite patterns: <b>LP001, LP108, LP109, LP110, LP118, LP128, LP131, LP143, LP146, LP147.</b></li> </ul> </li> </ul> </li> <li>• Door Styles <b>20, 2000, 2020, 2500, 2525, 4000.</b> <ul style="list-style-type: none"> <li>◦ Only available with a 12" [304.8mm], 18" [457.2mm] or 24" [609.6mm] radius.</li> <li>◦ Maximum rail width of 23" [584.2mm].</li> </ul> </li> </ul> <p><b>¼" Flat Panel</b></p> <ul style="list-style-type: none"> <li>• Vertical or horizontal grain.</li> <li>• Door Styles <b>40, 40*, 3271, 3272, 3291L, 3291R, 4020, 4030, 4040, 4040*, 4041, 4043, 4044, 4045, 4150.</b> <ul style="list-style-type: none"> <li>◦ Available in all standard radii 12" [304.8mm] or greater.</li> <li>◦ Available as a frame only or with a mullion lite pattern.                             <ul style="list-style-type: none"> <li>▪ Available lite patterns: <b>LP001, LP108, LP109, LP110, LP118, LP128, LP131, LP143, LP146, LP147.</b></li> </ul> </li> </ul> </li> <li>• Door styles <b>30, 3000, 3030, 3500, 3535, 5000.</b> <ul style="list-style-type: none"> <li>◦ Only available with a 12" [304.8mm], 18" [457.2mm] or 24" [609.6mm] radius.</li> <li>◦ Maximum rail width of 23" [584.2mm].</li> <li>◦ Not available with applied molding.</li> </ul> </li> </ul>
2	Mitered Mortise & Tenon Construction	<p><b>Raised Panel</b></p> <ul style="list-style-type: none"> <li>• Vertical grain only.</li> <li>• Door Styles <b>10M, 10M*.</b> <ul style="list-style-type: none"> <li>◦ Available in all standard radii 9" [228.6mm] or greater.</li> <li>◦ Available as a frame only or with a mullion lite pattern.                             <ul style="list-style-type: none"> <li>▪ Available lite patterns: <b>LP001, LP108, LP109, LP110, LP118, LP128, LP131, LP143, LP146, LP147.</b></li> </ul> </li> </ul> </li> </ul> <p><b>¼" Flat Panel</b></p> <ul style="list-style-type: none"> <li>• Vertical or horizontal grain.</li> <li>• Door Styles <b>40M, 40M*.</b> <ul style="list-style-type: none"> <li>◦ Available in all standard radii 12" [304.8mm] or greater.</li> <li>◦ Available as a frame only or with a mullion lite pattern.                             <ul style="list-style-type: none"> <li>▪ Available lite patterns: <b>LP001, LP108, LP109, LP110, LP118, LP128, LP131, LP143, LP146, LP147.</b></li> </ul> </li> </ul> </li> </ul>
3	French Miter Mortise & Tenon Construction	<p><b>Raised Panel</b></p> <ul style="list-style-type: none"> <li>• Vertical grain only.</li> <li>• Door styles <b>10FM, 10FM*.</b> <ul style="list-style-type: none"> <li>◦ Available in all standard radii 12" [304.8mm] or greater.</li> <li>◦ Available as a frame only or with a mullion lite pattern.                             <ul style="list-style-type: none"> <li>▪ Available lite patterns: <b>LP001, LP108, LP109, LP110, LP118, LP128, LP131, LP143, LP146, LP147.</b></li> </ul> </li> </ul> </li> <li>• Will be constructed with haunch and domino tenon joinery.             <ul style="list-style-type: none"> <li>◦ Results in a visibly similar appearance to standard French Miter construction.</li> </ul> </li> <li>• Please see <i>Sizes/Dimensions</i> notes in <i>Section B.7</i> for important information regarding stile &amp; rail widths when using French Miter construction.</li> </ul>

Continued on next page...

► For PRICING ► See Section D.1 in our current Wholesale Pricing Catalog.

Technical Notes: Convex/Concave Products...continued

Cabinet Door & Drawer Front Options (Chapter B)...continued

<b>D</b>	<b>3</b>	<b>French Miter Mortise &amp; Tenon Construction</b>	<p><b>¼" Flat Panel</b></p> <ul style="list-style-type: none"> <li>• Vertical or horizontal grain.</li> <li>• Door styles <b>40FM, 40FM*</b>.                             <ul style="list-style-type: none"> <li>◦ Available in all standard radii 12" [304.8mm] or greater.</li> <li>◦ Available as a frame only or with a mullion lite pattern.                                     <ul style="list-style-type: none"> <li>▪ Available lite patterns: <b>LP001, LP108, LP109, LP110, LP118, LP128, LP131, LP143, LP146, LP147.</b></li> </ul> </li> </ul> </li> <li>• Will be constructed with haunch and domino tenon joinery.                             <ul style="list-style-type: none"> <li>◦ Results in a visibly similar appearance to standard French Miter construction.</li> </ul> </li> <li>• Please see <i>Sizes/Dimensions</i> notes in <i>Section B.7</i> for important information regarding stile &amp; rail widths when using French Miter construction.</li> </ul>
	<b>4</b>	<b>Solid Wood Slab Styles</b>	<p>Only available with styles <b>1270, 1270*, 34SQA*</b> and <b>100SQE*</b>.</p> <ul style="list-style-type: none"> <li>• Vertical grain only.</li> <li>• Available in all standard radii.                             <ul style="list-style-type: none"> <li>◦ The radius may be affected by expansion, contraction and moisture issues.</li> </ul> </li> <li>• <b>Style 1270</b> doors are constructed with <b>NO battens</b>.</li> <li>• Convex/Concave solid wood slab styles will carry no warranty against warpage.</li> </ul> <p>A convex/concave solid wood slab in a 6", 9" or 12" radius, will need its individual staves machined from thicker material. Thicker material is not always available in all species. In these cases, the only way we can achieve this thickness is to laminate two layers together. This may result in the lamination line being visible on the outside edges of the final product.</p> <ul style="list-style-type: none"> <li>• See <i>Section S.3</i> for possible thickness restrictions based on wood species.</li> </ul>
	<b>5</b>	<b>Veneered MDF Slab Styles</b>	<p>Only available with styles <b>60</b> and <b>60*</b>.</p> <ul style="list-style-type: none"> <li>• Vertical or horizontal grain.</li> <li>• Available in all standard radii.</li> <li>• Only available with Edgeband Treatment options <b>EBT201, EBT201-R, EBT401</b> and <b>EBT401-R</b>.</li> </ul>
	<b>6</b>	<b>Raw MDF 1-Piece Slab Styles</b>	<p>Only available with styles <b>500</b> and <b>500*</b>.</p> <ul style="list-style-type: none"> <li>• Available in all standard radii.</li> </ul>

Convex/Concave Options (Chapter D)

<b>1</b>	<b>Identifying Curved Products</b>	This symbol  is used throughout the catalog to represent profiles and options that are available when ordering Convex/Concave products.
----------	------------------------------------	--

Design Options (Chapter G)

<b>1</b>	<b>Center Panel Face Routing</b>	<p>All center panel face rout options (excluding <b>CPFR3700</b>) from <i>Section G.7</i> are available, but limited to convex products only.</p> <p>Center panel face rout patterns from <i>Section G.8</i> are not an available option for convex/concave products.</p>
<b>2</b>	<b>Decorative Inserts</b>	<p>The following decorative peg inserts are available convex/concave: <b>DP100, DP200, DP400, DP500, DP700, DP800, DP900, DP1000, DP1100, DP1200, DP1300, DP1400, DP1500, DP1600, DP2000, DP2100.</b></p> <p>The butterfly insert (<b>BI100</b>) is <i>not an option</i> for convex/concave products.</p>

Face Frame Options (Chapter J)

<b>1</b>	<b>Face Frame Construction</b>	<p>Assembled Convex/Concave face frames are available with all face frame stock profiles (<b>FS100 - FS108</b>).</p> <ul style="list-style-type: none"> <li>• Please see <i>Section J.1</i> for additional profile information.</li> <li>• <b>FS100</b> is available with all standard radii.</li> <li>• <b>FS101</b> through <b>FS108</b> are available with radii 12" [304.8mm] or greater.</li> <li>• Face frames with a radius of 24" [609.6mm] or greater will be constructed with pocket screw joinery.</li> <li>• Face frames with a radius under 24" [609.6mm] will be constructed with Domino Tenon Joinery where all rails meet the stiles.                             <ul style="list-style-type: none"> <li>◦ Pocket Screw joinery will be used where center stiles meet the rails.</li> </ul> </li> </ul> <p>Convex/Concave face frames are not available Ready to Assemble (RTA).</p> <p>WalzCraft does not offer individual face frame components (ie: top and/or bottom rail only) for use with Convex/Concave configurations.</p> <ul style="list-style-type: none"> <li>• WalzCraft must assemble all Convex/Concave face frames, rather than the customer, as there is a high risk of individual components warping if left unassembled for any length of time.</li> </ul>
<b>2</b>	<b>Inset/Pre-Fit</b>	If choosing the inset/pre-fit option ( <i>Section J.6</i> ) for your convex/concave doors, the minimum allowable gap will be 3.0mm.

Continued on next page...

► For PRICING ► See *Section D.1* in our current Wholesale Pricing Catalog.

Technical Notes: Convex/Concave Products...continued

Finish Options (Chapter R)

1	3D Laminate (RTF)	3D Laminate (RTF) is not an option for curved products.
---	-------------------	---

Functional Options (Chapter F)

1	Hinge Boring	Convex/Concave doors and drawer fronts are only available with <b>HBP100</b> . Please see <i>Section E.1</i> for additional hinge boring requirements, ordering instructions and compatibility.
---	--------------	---

General Information (Chapter A)

1	Ready to Assemble (RTA)	RTA is <i>not</i> available as an option.
2	Warranty	Please see <i>Section A.8 - Warranties</i> for more information on Glued Up Panel expansion/contraction, warping, bowing and twisting.

Material Options

1	Maple - Hard vs. Soft	For quality reasons, product requiring CNC machining will not be available in any Maple-Hard/Soft-Mixed species or Maple-Soft species. These items should instead be ordered in any of our Maple-Hard species.
---	-----------------------	--

Molding Options (Chapter N)

1	Convex/Concave Crown Molding Profile Options	These Convex/Concave moldings and their matching crown moldings are also available in straight 8' [2438.4mm] lengths to use throughout your project.
2	Drawing Scale	Convex/Concave moldings and matching crown moldings in <i>Section D.4</i> are drawn at full scale.

Profile Options

1	Center Panel Grain Direction Options	WalzCraft prefers that <b>ALL convex/concave solid wood slabs and solid wood center panels</b> have a <b>vertical grain</b> direction, <b>including paint grades</b> , to help ensure quality and avoid any warping, cupping or twisting that may occur.
		<p>¾" [19.1mm] thick convex/concave raised panel doors use a ⅝" [15.9mm] thick solid wood profiled center panel that will be flush with the stiles and rails on the <b>face only</b>.</p> <ul style="list-style-type: none"> <li>The center panel will be recessed below the stiles and rails on the back side of the door.</li> </ul>
		<p>Center panels with <b>vertical grain</b> are available in:</p> <ul style="list-style-type: none"> <li>¼" [6.4mm] flat panel wood veneers, raw MDF or raw MDF-MR.</li> <li>⅝" [15.9mm] solid wood raised panels</li> <li>⅜" [9.5mm] solid wood, raw MDF, raw MDF-MR <b>RVSCP-PR324</b> (<i>Reversed Solid Center Panel</i>) profile</li> </ul> <p>Center panels with <b>horizontal grain</b> are available in:</p> <ul style="list-style-type: none"> <li>¼" [6.4mm] Flat Panel wood veneer doors and drawer fronts.                             <ul style="list-style-type: none"> <li>Only available for radii 12" [304.8mm] or greater.</li> <li>Only available for arc lengths 31½" [800mm] or less.</li> <li>Maximum interior visual opening height is 47½" [1197mm].</li> </ul> </li> <li><b>Style 60</b> Slab veneer doors</li> </ul>
2	RAM Routs	RAM Routs ( <i>Section E.6</i> ) are available on convex products only. Not available concave. Additional charges will apply. <ul style="list-style-type: none"> <li>See <i>Section E.9</i> and <i>Section E.10</i> for convex/concave compatible miter profiles.</li> <li>See <i>Section N.5</i> and <i>Section N.13</i> for convex/concave compatible applied molding.</li> </ul>
3	Pre-Finishing Options	Finishing Options for convex/concave doors or drawer fronts with <b>Vertical</b> grain on the center panel: <ul style="list-style-type: none"> <li><b>Stain Pre-finishing</b></li> <li><b>Priming for Paint</b> <i>only</i></li> <li><b>SolidTone®</b> finish</li> <li><b>SolidTone® WoodGrain</b></li> </ul>
		Finishing Options for convex/concave doors or drawer fronts with <b>Horizontal</b> grain on the center panel: <ul style="list-style-type: none"> <li><b>Stain Pre-finishing</b></li> <li><b>SolidTone® WoodGrain</b></li> </ul>

Continued on next page...

► For PRICING ► See Section **D.1** in our current Wholesale Pricing Catalog.

## Technical Notes: Convex/Concave Products...continued

### Sizes/Dimensions...continued

<b>D</b>	<b>4</b>	<b>Standard &amp; Non-Standard Part Sizes</b>	<p>Stiles and rails for traditional doors, drawer fronts and face frames can be ordered from 1½" [38.1mm] wide to 4½" [114.3mm] wide, in ¼" [6.4mm] increments and will not be subject to additional charges. Stiles and rails ordered in widths outside of these dimensions will incur a Non-Standard Part Size charge. See <b>Section A.5</b> for more information.</p> <p>Stiles and rails for mitered doors using any of the convex/concave compatible profiles from <b>Sections E.9</b> and <b>E.10</b> of the <b>Product Specification Catalog</b> are only available at the widths shown. Requests for widths other than those shown will be reviewed and may incur an upcharge.</p>
	<b>5</b>	<b>Door/Face Frame Max Height</b>	Maximum height for doors and face frames is 96" [2438.4mm].
	<b>6</b>	<b>(**) Convex Product Radii 11⅝", 12½", 23⅝", 24½"</b>	<p>All radii are based on ¾" [19.1mm] thick doors (or face frame when ordering a face frame only).</p> <p>All radii are calculated to the center of a ¾" [19.1mm] thick door (or face frame when ordering a face frame only).</p> <p>11⅝" [295.3mm], 12½" [317.5mm], 23⅝" [600.1mm], 24½" [622.3mm] radii only available convex.</p> <ul style="list-style-type: none"> <li>• These radii are not available on doors with shaped rails (ex: Door Style 20).</li> </ul> <p><b>11⅝" [295.3mm] Radius:</b> When ordering a face frame only or an inset/prefit door and face frame, a 11⅝" [295.3mm] radius will give you a 12" [304.8mm] radius at the face of the face frame when the face frame is ¾" [19.1mm] thick.</p> <p><b>12½" [317.5mm] Radius:</b> When ordering a door only or a door and face frame, a 12½" [317.5mm] radius will give you a 12" [304.8mm] radius at the face of the face frame when the door and face frame are ¾" [19.1mm] thick and the gap between the door and face frame is ⅝" [3.8mm].</p> <p><b>23⅝" [600.1mm] Radius:</b> When ordering a face frame only or an inset/prefit door and face frame, a 23⅝" [600.1mm] radius will give you a 24" [609.6mm] radius at the face of the face frame when the face frame is ¾" [19.1mm] thick.</p> <p><b>24½" [622.3mm] Radius:</b> When ordering a door only or a door and face frame, a 24½" [622.3mm] radius will give you a 24" [609.6mm] radius at the face of the face frame when the door and face frame are ¾" thick and the gap between the door and face frame is ⅝" [3.8mm].</p> <p>See <b>Section D.2</b> for more information on convex products.</p>
	<b>7</b>	<b>Maximum Rail Size</b>	The maximum rail height for Convex/Concave doors and drawer fronts is 8" [203.2mm].

### Convex/Concave - General Information - END

► For PRICING ► See **Section D.1** in our current Wholesale Pricing Catalog.