

Slab Drawer / Traditional Mortise & Tenon Door  
(S100) Unity



Slab Drawer / Mitered Mortise & Tenon Door  
(S382) Piedmont



Traditional Mortise & Tenon Mullion Door  
(S733) LP114 - 12 Lites



Traditional Mortise & Tenon Louvered Door  
(S363) Lakeshore



## Chapter B Table of Contents

Section #	Section Name/Contents	Page #
B.1	Traditional Mortise & Tenon - Raised Panel	<a href="#">B.1.2</a>
B.2	Quarter, Half Circle & Gothic - Raised Panel (Traditional M/T)	<a href="#">B.2.1</a>
B.3	Traditional Mortise & Tenon - 1/4" Flat Panel	<a href="#">B.3.1</a>
B.4	Quarter, Half Circle & Gothic - 1/4" Flat Panel (Traditional M/T)	<a href="#">B.4.1</a>
B.5	Mitered ( <i>Mitre</i> ) Mortise & Tenon - Raised Panel	<a href="#">B.5.1</a>
B.6	Mitered ( <i>Mitre</i> ) Mortise & Tenon - 1/4" Flat Panel	<a href="#">B.6.1</a>
B.7	French Miter & Adventure Series	<a href="#">B.7.1</a>
	◦ French Miter Mortise & Tenon - Raised & 1/4" Flat Panel	<a href="#">B.7.1</a>
	◦ Adventure Series - Raised & 1/4" Flat Panel	<a href="#">B.7.5</a>
B.8	No-Panel Cut (NPC) Frame Only Doors	<a href="#">B.8.1</a>
	◦ No-Panel Cut (NPC) Frame Only Doors - Applied Moldings	<a href="#">B.8.1</a>
B.9	Contemporary	<a href="#">B.9.1</a>
	◦ Contemporary Slab & Batten Doors	<a href="#">B.9.1</a>
	◦ Contemporary Mortise & Tenon Doors	<a href="#">B.9.4</a>
B.10	Veneered & Edgebanded - Standard Veneer	<a href="#">B.10.1</a>
	◦ Applied Molding Outside Edge Profiles	<a href="#">B.10.13</a>
B.11	Veneered & Edgebanded - Reconstituted Veneer	<a href="#">B.11.1</a>
B.12	Frame Only & Mullion Lite Patterns	<a href="#">B.12.1</a>
	◦ Frame & Mullion Lite Pattern Options	<a href="#">B.12.1</a>
	◦ Formula for Glass Size Calculation	<a href="#">B.12.7</a>
	◦ Half Lap Mullion Construction	<a href="#">B.12.7</a>
	◦ Rubber Glass Retainer	<a href="#">B.12.7</a>
	◦ Lite Types - Standard, True/Divider Molding, True/Retainer Groove	<a href="#">B.12.8</a>
B.13	◦ Wood Retainer Molding	<a href="#">B.12.9</a>
	Combination Frame & Panel	<a href="#">B.13.1</a>
B.14	Louvered/Wood Shutters - Open ( <i>Allows Air Flow and Light Penetration</i> )	<a href="#">B.14.1</a>
	◦ Operable/Adjustable Louvers	<a href="#">B.14.1</a>
	◦ Non-Operable (Fixed) Louvers	<a href="#">B.14.2</a>
B.15	Louvered/Wood Shutters - Closed ( <i>No Air Flow or Light Penetration</i> )	<a href="#">B.15.1</a>
	◦ Slat Applied Molding Options	<a href="#">B.15.2</a>
	◦ Beaded/Reeded Applied Molding Options	<a href="#">B.15.2</a>
B.16	Drawer Fronts - Slab and RP (Raised Panel)	<a href="#">B.16.1</a>
B.17	Drawer Fronts - Molded	<a href="#">B.17.1</a>
B.18	Onlay Frames	<a href="#">B.18.1</a>
B.19	Pyramid Panel Doors & Drawer Fronts	<a href="#">B.19.1</a>
B.20	Nexus Doors & Drawer Fronts	<a href="#">B.20.1</a>

**Cabinet Door & Drawer Front Options**

**Traditional Mortise & Tenon - Raised Panel**

**B**

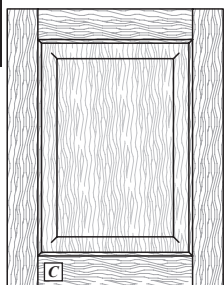

**Style: 10**

**PC: 101**  
**Frame: PC101 x 0.6**  
**Min. Size: 8x8**  
 [203.2mm x 203.2mm]

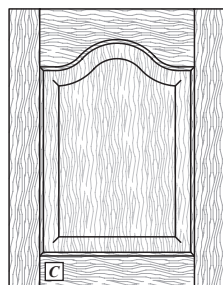

**Style: 20**

**PC: 102**  
**Frame: PC102 x 0.6**  
**Min. Size: 8x9<sup>3</sup>/<sub>4</sub>**  
 [263.5mm x 247.7mm]

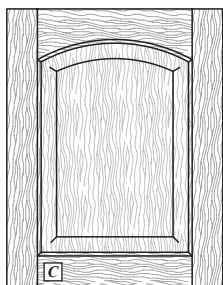

**Style: 2000**

**PC: 102**  
**Frame: PC102 x 0.6**  
**Min. Size: 8x9<sup>3</sup>/<sub>4</sub>**  
 [203.2mm x 247.7mm]

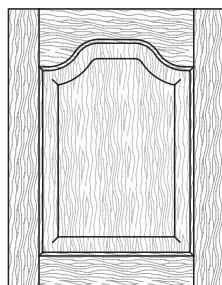

**Style: 2200**

**PC: 102**  
**Frame: PC102 x 0.6**  
**Min. Size: 8x9<sup>3</sup>/<sub>4</sub>**  
 [294.5mm x 247.7mm]

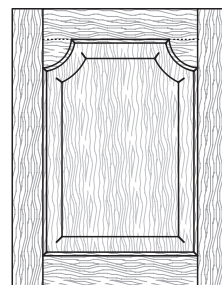

**Style: 1090**

**PC: 107**  
**Frame: PC107 x 0.6**  
**Min. Size: 11<sup>5</sup>/<sub>8</sub>x9<sup>13</sup>/<sub>16</sub>**  
 [295.3mm x 249.2mm]

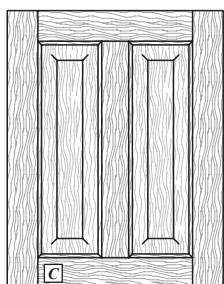

**Style: 1010**

**PC: 103**  
**Frame: PC103 x 0.6**  
**Min. Size: 13<sup>3</sup>/<sub>8</sub>x8**  
 [349.3mm x 203.2mm]

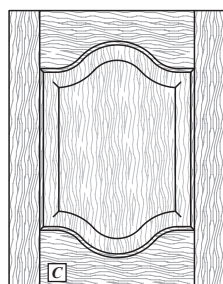

**Style: 2020**

**PC: 106**  
**Frame: PC106 x 0.6**  
**Min. Size: 8x11<sup>1</sup>/<sub>2</sub>**  
 [263.5mm x 292.1mm]

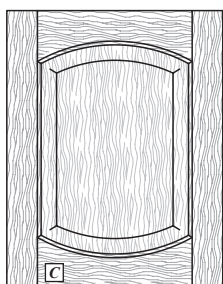

**Style: 4000**

**PC: 106**  
**Frame: PC106 x 0.6**  
**Min. Size: 8x11<sup>1</sup>/<sub>2</sub>**  
 [203.2mm x 292.1mm]

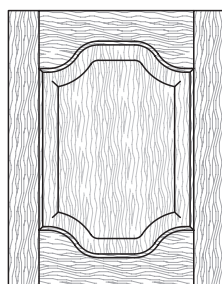

**Style: 2222**

**PC: 106**  
**Frame: PC106 x 0.6**  
**Min. Size: 8x11<sup>1</sup>/<sub>2</sub>**  
 [203.2mm x 292.1mm]

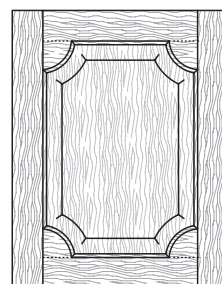

**Style: 1080**

**PC: 111**  
**Frame: PC111 x 0.6**  
**Min. Size: 11<sup>5</sup>/<sub>8</sub>x11<sup>5</sup>/<sub>8</sub>**  
 [295.3mm x 295.3mm]

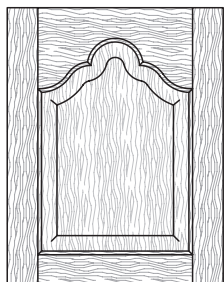

**Style: 7000**

**PC: 104**  
**Frame: PC104 x 0.6**  
**Min. Size: 12x11<sup>1</sup>/<sub>4</sub>**  
 [304.8mm x 285.8mm]

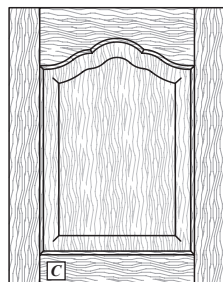

**Style: 2500**

**PC: 102**  
**Frame: PC102 x 0.6**  
**Min. Size: 8x9<sup>3</sup>/<sub>4</sub>**  
 [203.2mm x 247.7mm]

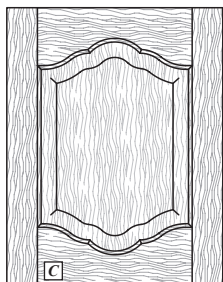

**Style: 2525**

**PC: 106**  
**Frame: PC106 x 0.6**  
**Min. Size: 8x11<sup>1</sup>/<sub>2</sub>**  
 [203.2mm x 292.1mm]

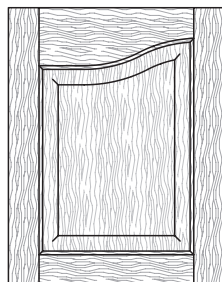

**Style: 2070L**

**PC: 102**  
**Frame: PC102 x 0.6**  
**Min. Size: 8x9<sup>3</sup>/<sub>4</sub>**  
 [203.2mm x 247.7mm]

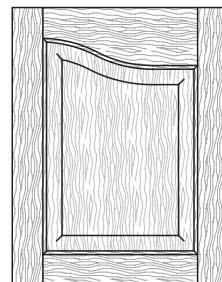

**Style: 2070R**

**PC: 102**  
**Frame: PC102 x 0.6**  
**Min. Size: 8x9<sup>3</sup>/<sub>4</sub>**  
 [203.2 mm x 247.7mm]

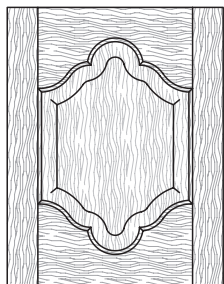

**Style: 7070**

**PC: 109**  
**Frame: PC109 x 0.6**  
**Min. Size: 12x14<sup>1</sup>/<sub>2</sub>**  
 [304.8mm x 368.3mm]

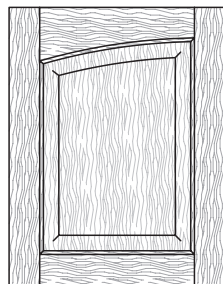

**Style: 2001L**

**PC: 102**  
**Frame: PC102 x 0.6**  
**Min. Size: 8x9<sup>3</sup>/<sub>4</sub>**  
 [203.2mm x 247.7mm]

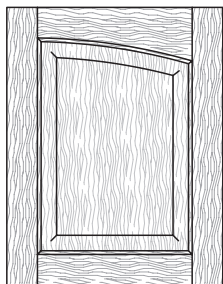

**Style: 2001R**

**PC: 102**  
**Frame: PC102 x 0.6**  
**Min. Size: 8x9<sup>3</sup>/<sub>4</sub>**  
 [203.2mm x 247.7mm]

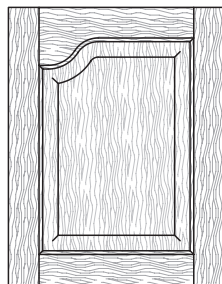

**Style: 2201L**

**PC: 102**  
**Frame: PC102 x 0.6**  
**Min. Size: 8x9<sup>3</sup>/<sub>4</sub>**  
 [203.2mm x 247.7mm]

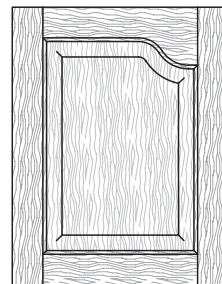

**Style: 2201R**

**PC: 102**  
**Frame: PC102 x 0.6**  
**Min. Size: 8x9<sup>3</sup>/<sub>4</sub>**  
 [203.2mm x 247.7mm]

► **For PRICING** ► See Section **B.1** in our current Wholesale Pricing Catalog.



**Traditional Mortise & Tenon - Raised Panel**

**Cabinet Door & Drawer Front Options**

**B**

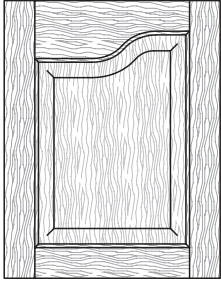

**Style: 2800L**

PC: 102  
Frame: PC102 x 0.6  
Min. Size: 12x9¼  
[304.8mm x 247.7mm]

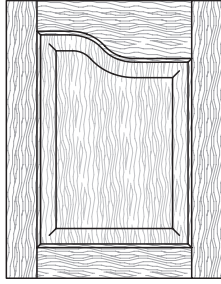

**Style: 2800R**

PC: 102  
Frame: PC102 x 0.6  
Min. Size: 12x9¼  
[304.8mm x 247.7mm]

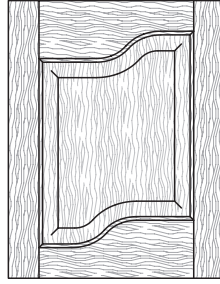

**Style: 2828L**

PC: 106  
Frame: PC106 x 0.6  
Min. Size: 12x11½  
[304.8mm x 292.1mm]

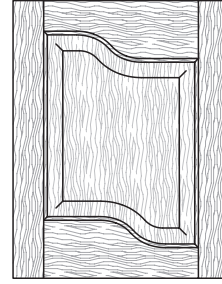

**Style: 2828R**

PC: 106  
Frame: PC106 x 0.6  
Min. Size: 12x11½  
[304.8mm x 292.1mm]

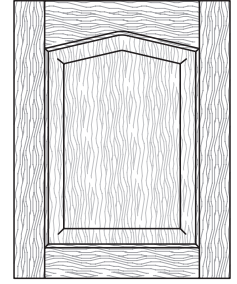

**Style: 25**

PC: 102  
Frame: PC102 x 0.6  
Min. Size: 8x9¼  
[203.2mm x 247.7mm]

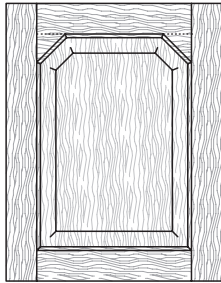

**Style: 1060**

PC: 107  
Frame: PC107 x 0.6  
Min. Size: 9x10¼  
[228.6mm x 273.1mm]

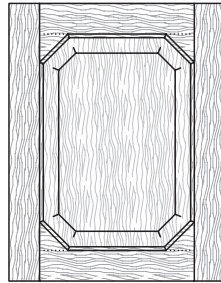

**Style: 1070**

PC: 111  
Frame: PC111 x 0.6  
Min. Size: 9x12½  
[228.6mm x 317.5mm]

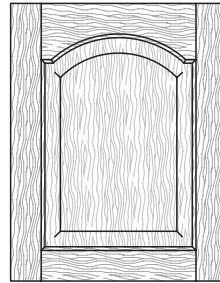

**Style: 2005**

PC: 102  
Frame: PC102 x 0.6  
Min. Size: 8x9¼  
[203.2mm x 247.7mm]

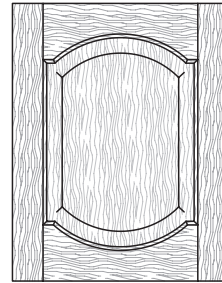

**Style: 2055**

PC: 106  
Frame: PC106 x 0.6  
Min. Size: 8x11½  
[203.2mm x 292.1mm]

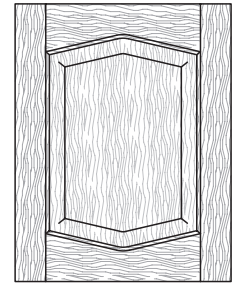

**Style: 2727**

PC: 106  
Frame: PC106 x 0.6  
Min. Size: 8x11½  
[203.2mm x 292.1mm]

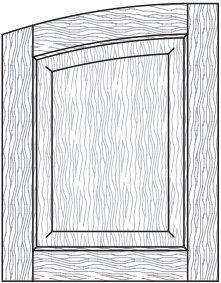

**Style: 2011L**

PC: 123  
Frame: PC123 x 0.6  
Min. Size: 8x9¼  
[203.2mm x 247.7mm]

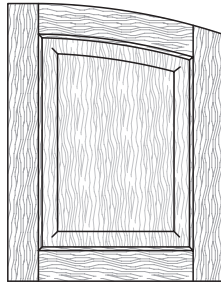

**Style: 2011R**

PC: 123  
Frame: PC123 x 0.6  
Min. Size: 8x9¼  
[203.2mm x 247.7mm]

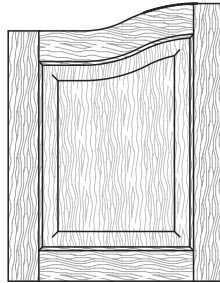

**Style: 2077L**

PC: 123  
Frame: PC123 x 0.6  
Min. Size: 8x9¼  
[203.2mm x 247.7mm]

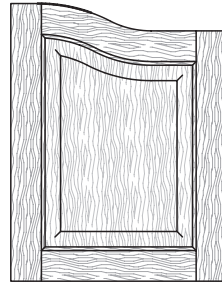

**Style: 2077R**

PC: 123  
Frame: PC123 x 0.6  
Min. Size: 8x9¼  
[203.2mm x 247.7mm]

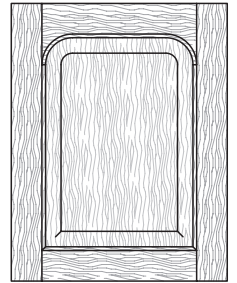

**Style: 1055**

PC: 119  
Frame: PC119 x 0.6  
Min. Size: 9x9¼  
[228.6mm x 247.7mm]

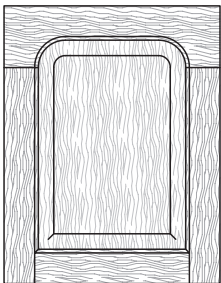

**Style: 1065**

PC: 130  
Frame: PC130 x 0.6  
Min. Size: 9x9¼  
[228.6mm x 247.7mm]

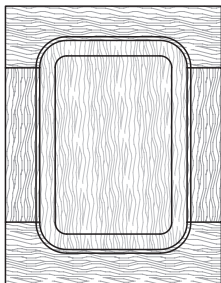

**Style: 1075**

PC: 120  
Frame: PC120 x 0.6  
Min. Size: 9x11½  
[228.6mm x 292.1mm]

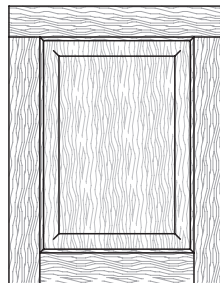

**Style: 1800**

PC: 118  
Frame: PC118 x 0.6  
Min. Size: 8x8  
[203.2mm x 203.2mm]

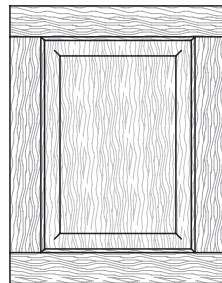

**Style: 1801**

PC: 101  
Frame: PC101 x 0.6  
Min. Size: 8x8  
[203.2mm x 203.2mm]

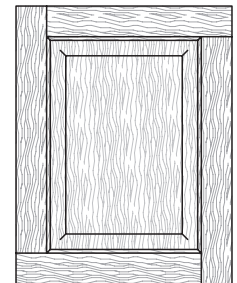

**Style: 2433**

PC: 118  
Frame: PC118 x 0.6  
Min. Size: 8x8  
[203.2mm x 203.2mm]

► **For PRICING** ► See Section *B.1* in our current Wholesale Pricing Catalog.

**Cabinet Door & Drawer Front Options**

**Traditional Mortise & Tenon - Raised Panel**

**B**

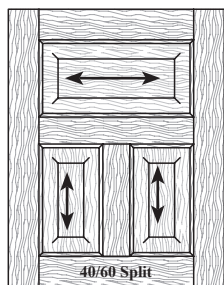

**Style: 8010**

PC: 131  
 Frame: PC131 x 0.6  
 Min. Size: 13<sup>3</sup>/<sub>4</sub>x15<sup>1</sup>/<sub>2</sub>  
 [349.3mm x 393.7mm]

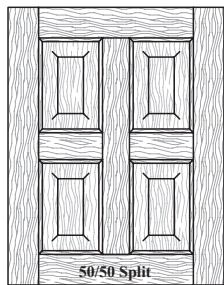

**Style: 8160**

PC: 115  
 Frame: PC115 x 0.6  
 Min. Size: 13<sup>3</sup>/<sub>4</sub>x13<sup>3</sup>/<sub>4</sub>  
 [349.3mm x 349.3mm]

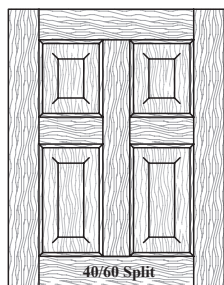

**Style: 8170**

PC: 115  
 Frame: PC115 x 0.6  
 Min. Size: 13<sup>3</sup>/<sub>4</sub>x15<sup>1</sup>/<sub>2</sub>  
 [349.3mm x 393.7mm]

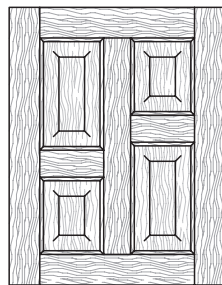

**Style: 8060L**

PC: 132  
 Frame: PC132 x 0.6  
 Min. Size: 13<sup>3</sup>/<sub>4</sub>x15<sup>1</sup>/<sub>2</sub>  
 [349.3mm x 393.7mm]

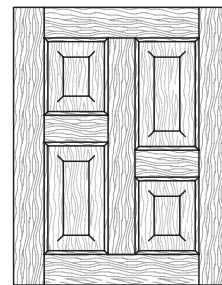

**Style: 8060R**

PC: 132  
 Frame: PC132 x 0.6  
 Min. Size: 13<sup>3</sup>/<sub>4</sub>x15<sup>1</sup>/<sub>2</sub>  
 [349.3mm x 393.7mm]

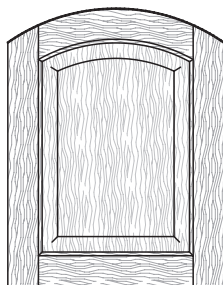

**Style: 2187**

PC: 123  
 Frame: PC123 x 0.6  
 Min. Size: 8x9<sup>3</sup>/<sub>4</sub>  
 [203.2mm x 247.7mm]

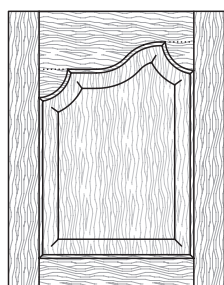

**Style: 2100L**

PC: 121  
 Frame: PC121 x 0.6  
 Fixed Min: 12x11<sup>3</sup>/<sub>4</sub>  
 [304.8mm x 284.2mm]

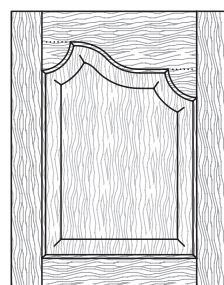

**Style: 2100R**

PC: 121  
 Frame: PC121 x 0.6  
 Fixed Min: 12x11<sup>3</sup>/<sub>4</sub>  
 [304.8mm x 284.2mm]

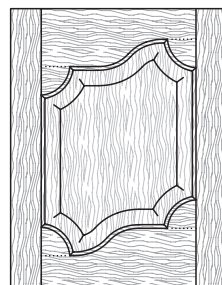

**Style: 2121L**

PC: 124  
 Frame: PC124 x 0.6  
 Fixed Min: 12x12<sup>5</sup>/<sub>8</sub>  
 [304.8mm x 320.7mm]

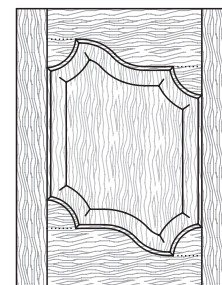

**Style: 2121R**

PC: 124  
 Frame: PC124 x 0.6  
 Fixed Min: 12x12<sup>5</sup>/<sub>8</sub>  
 [304.8mm x 320.7mm]

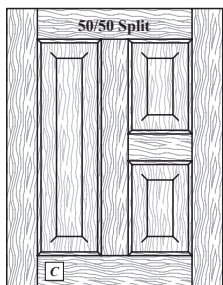

**Style: 2291L**

PC: 131  
 Frame: PC131 x 0.6  
 Min. Size: 13<sup>3</sup>/<sub>4</sub>x13<sup>3</sup>/<sub>4</sub>  
 [349.3mm x 349.3mm]

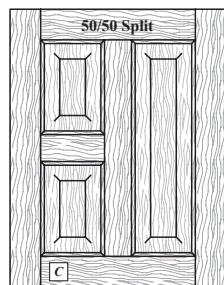

**Style: 2291R**

PC: 131  
 Frame: PC131 x 0.6  
 Min. Size: 13<sup>3</sup>/<sub>4</sub>x13<sup>3</sup>/<sub>4</sub>  
 [349.3mm x 349.3mm]



**Style: 2524**

PC: 105  
 Frame: PC105 x 0.6  
 Min. Size: 8x15<sup>1</sup>/<sub>2</sub>  
 [203.2mm x 393.7mm]

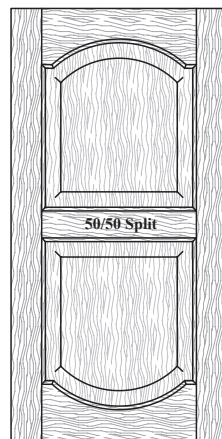

**Style: 2755**

PC: 112  
 Frame: PC112 x 0.6  
 Min. Size: 8x17<sup>1</sup>/<sub>8</sub>  
 [203.2mm x 435mm]

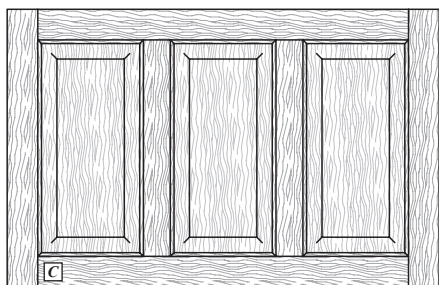

**Style: 8020**

PC: 108  
 Frame: PC108 x 0.6  
 Min. Size: 19<sup>1</sup>/<sub>2</sub>x8  
 [495.3mm x 203.2mm]

► **For PRICING** ► See Section **B.1** in our current Wholesale Pricing Catalog.



**Traditional Mortise & Tenon - Raised Panel**

**Cabinet Door & Drawer Front Options**

**B**

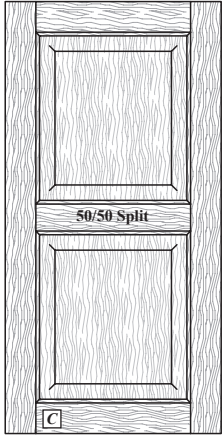

**Style: 8000**

PC: 103  
 Frame: PC103 x 0.6  
 Min. Size: 8x13<sup>3</sup>/<sub>4</sub>  
 [203.2mm x 349.3mm]



**Style: 1000**

PC: 103  
 Frame: PC103 x 0.6  
 Min. Size: 8x15<sup>1</sup>/<sub>2</sub>  
 [203.2mm x 393.7mm]



**Style: 1941**

PC: 103  
 Frame: PC103 x 0.6  
 Min. Size: 8x16<sup>3</sup>/<sub>8</sub>  
 [203.2mm x 415.9mm]



**Style: 8045**

PC: 103  
 Frame: PC103 x 0.6  
 Min. Size: 8x16<sup>3</sup>/<sub>8</sub>  
 [203.2mm x 415.9mm]

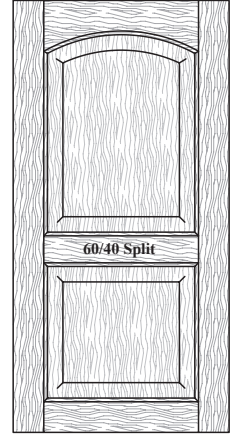

**Style: 2050**

PC: 105  
 Frame: PC105 x 0.6  
 Min. Size: 8x15<sup>1</sup>/<sub>2</sub>  
 [203.2mm x 393.7mm]

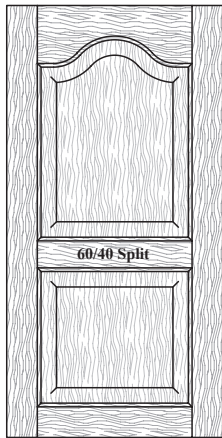

**Style: 2010**

PC: 105  
 Frame: PC105 x 0.6  
 Min. Size: 8x15<sup>1</sup>/<sub>2</sub>  
 [203.2mm x 393.7mm]



**Style: 2210**

PC: 105  
 Frame: PC105 x 0.6  
 Min. Size: 8x15<sup>1</sup>/<sub>2</sub>  
 [203.2mm x 393.7mm]



**Style: 2105**

PC: 105  
 Frame: PC105 x 0.6  
 Min. Size: 8x15<sup>1</sup>/<sub>2</sub>  
 [203.2mm x 393.7mm]



**Style: 2505**

PC: 105  
 Frame: PC105 x 0.6  
 Min. Size: 8x15<sup>1</sup>/<sub>2</sub>  
 [203.2mm x 393.7mm]

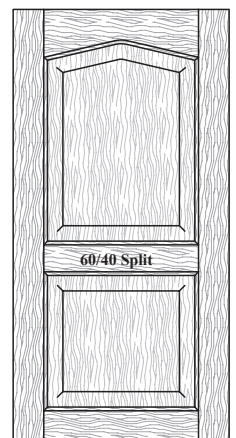

**Style: 2550**

PC: 105  
 Frame: PC105 x 0.6  
 Min. Size: 8x15<sup>1</sup>/<sub>2</sub>  
 [203.2mm x 393.7mm]

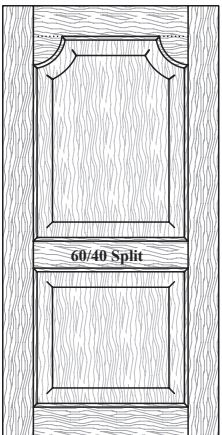

**Style: 1020**

PC: 114  
 Frame: PC114 x 0.6  
 Min. Size: 11<sup>5</sup>/<sub>8</sub>x15<sup>1</sup>/<sub>2</sub><sup>3</sup>/<sub>2</sub>  
 [295.3mm x 396.1mm]



**Style: 7010**

PC: 113  
 Frame: PC113 x 0.6  
 Min. Size: 12x17  
 [304.8mm x 431.8mm]



**Style: 2323**

PC: 112  
 Frame: PC112 x 0.6  
 Min. Size: 8x17<sup>1</sup>/<sub>4</sub>  
 [203.2mm x 438.2mm]

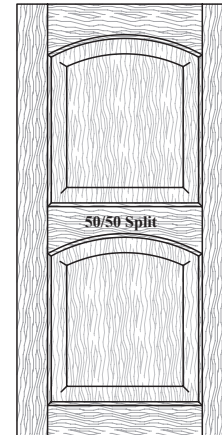

**Style: 2025**

PC: 112  
 Frame: PC112 x 0.62  
 Min. Size: 8x17<sup>1</sup>/<sub>4</sub>  
 [203.2mm x 438.2mm]

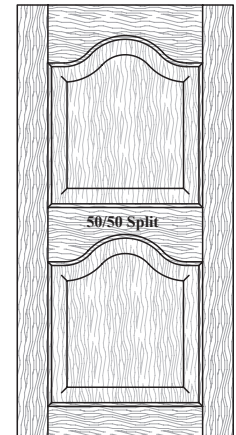

**Style: 2035**

PC: 112  
 Frame: PC112 x 0.6  
 Min. Size: 8x17<sup>1</sup>/<sub>4</sub>  
 [203.2mm x 438.2mm]

► **For PRICING** ► See Section **B.1** in our current Wholesale Pricing Catalog.

B



Style: 8050

PC: 132  
 Frame: PC132 x 0.6  
 Min. Size: 13<sup>3</sup>/<sub>4</sub>x23  
 [349.3mm x 584.2mm]

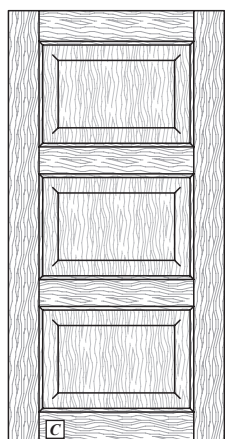

Style: 8030

PC: 108  
 Frame: PC108 x 0.6  
 Min. Size: 8x19<sup>1</sup>/<sub>2</sub>  
 [203.2mm x 495.3mm]

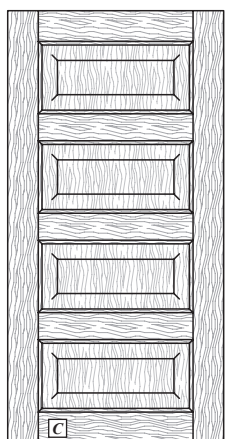

Style: 2271

PC: 115  
 Frame: PC115 x 0.6  
 Min. Size: 8x25<sup>1</sup>/<sub>4</sub>  
 [203.2mm x 641.4mm]

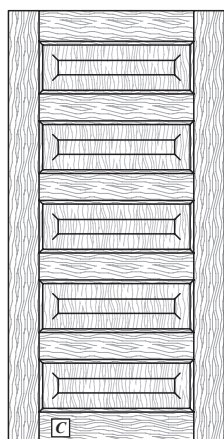

Style: 2272

PC: 117  
 Frame: PC117 x 0.6  
 Min. Size: 8x31  
 [203.2mm x 787.4mm]



Style: 2427

PC: 131  
 Frame: PC131 x 0.6  
 Min. Size: 13<sup>3</sup>/<sub>4</sub>x16<sup>3</sup>/<sub>8</sub>  
 [349.3mm x 415.9mm]

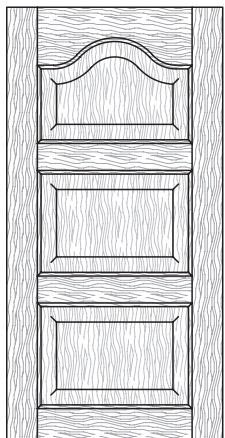

Style: 2185

PC: 110  
 Frame: PC110 x 0.6  
 Min. Size: 8x21<sup>1</sup>/<sub>4</sub>  
 [203.2mm x 539.8mm]

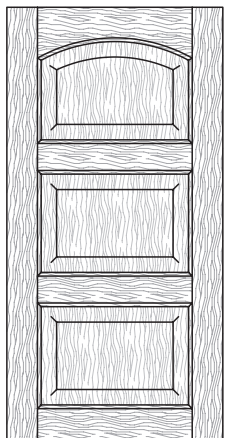

Style: 2186

PC: 110  
 Frame: PC110 x 0.6  
 Min. Size: 8x21<sup>1</sup>/<sub>4</sub>  
 [203.2mm x 539.8mm]

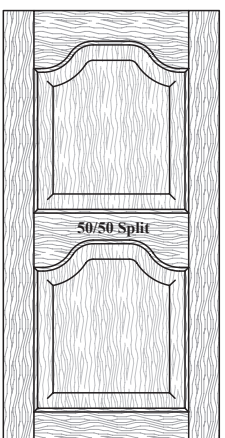

Style: 2036

PC: 112  
 Frame: PC112 x 0.6  
 Min. Size: 8x17<sup>1</sup>/<sub>4</sub>  
 [203.2mm x 438.2mm]



Style: 2422L

PC: 105  
 Frame: PC105 x 0.6  
 Min. Size: 8x15<sup>1</sup>/<sub>2</sub>  
 [203.2mm x 393.7mm]



Style: 2422R

PC: 105  
 Frame: PC105 x 0.6  
 Min. Size: 8x15<sup>1</sup>/<sub>2</sub>  
 [203.2mm x 393.7mm]

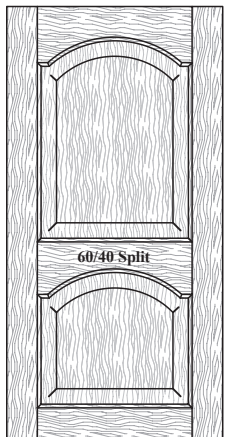

Style: 2288

PC: 112  
 Frame: PC112 x 0.6  
 Min. Size: 8x16<sup>3</sup>/<sub>8</sub>  
 [203.2mm x 422.3mm]



Style: 2418

PC: 128  
 Frame: PC128 x 0.6  
 Min. Size: 11<sup>5</sup>/<sub>8</sub>x17<sup>3</sup>/<sub>8</sub>  
 [295.3mm x 441.3mm]



Style: 2420L

PC: 105  
 Frame: PC105 x 0.6  
 Min. Size: 8x15<sup>1</sup>/<sub>2</sub>  
 [203.2mm x 393.7mm]



Style: 2420R

PC: 105  
 Frame: PC105 x 0.6  
 Min. Size: 8x15<sup>1</sup>/<sub>2</sub>  
 [203.2mm x 393.7mm]

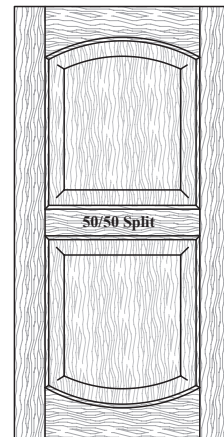

Style: 2425

PC: 112  
 Frame: PC112 x 0.6  
 Min. Size: 8x17<sup>1</sup>/<sub>4</sub>  
 [203.2mm x 438.2mm]

► For PRICING ► See Section B.1 in our current Wholesale Pricing Catalog.

**Traditional Mortise & Tenon - Raised Panel**

**Cabinet Door & Drawer Front Options**

**B**

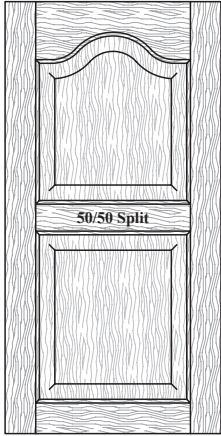

**Style: 2818**

PC: 105  
 Frame: PC105 x 0.6  
 Min. Size: 8x17¼  
 [203.2mm x 438.2mm]

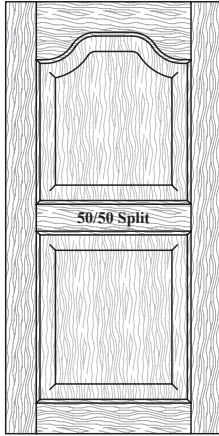

**Style: 2820**

PC: 105  
 Frame: PC105 x 0.6  
 Min. Size: 8x17¼  
 [203.2mm x 438.2mm]



**Style: 2822**

PC: 105  
 Frame: PC105 x 0.6  
 Min. Size: 8x15½  
 [203.2mm x 393.7mm]



**Style: 2824**

PC: 105  
 Frame: PC105 x 0.6  
 Min. Size: 8x15½  
 [203.2mm x 393.7mm]

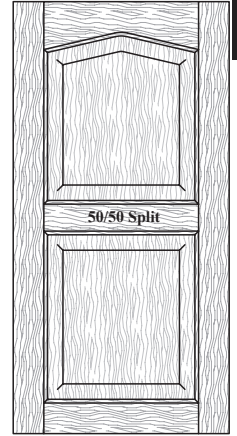

**Style: 2826**

PC: 105  
 Frame: PC105 x 0.6  
 Min. Size: 8x15½  
 [203.2mm x 393.7mm]

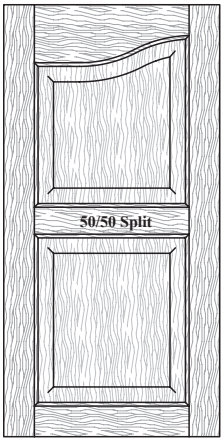

**Style: 2836L**

PC: 105  
 Frame: PC105 x 0.6  
 Min. Size: 8x16<sup>11</sup>/<sub>16</sub>  
 [203.2mm x 423.9mm]

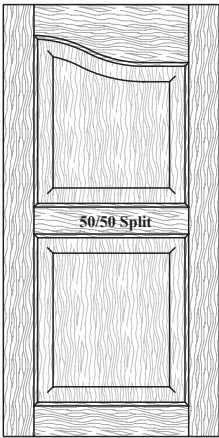

**Style: 2836R**

PC: 105  
 Frame: PC105 x 0.6  
 Min. Size: 8x16<sup>11</sup>/<sub>16</sub>  
 [203.2mm x 423.9mm]



**Style: 2846L**

PC: 105  
 Frame: PC105 x 0.6  
 Min. Size: 8x15½  
 [203.2mm x 393.7mm]



**Style: 2846R**

PC: 105  
 Frame: PC105 x 0.6  
 Min. Size: 8x15½  
 [203.2mm x 393.7mm]

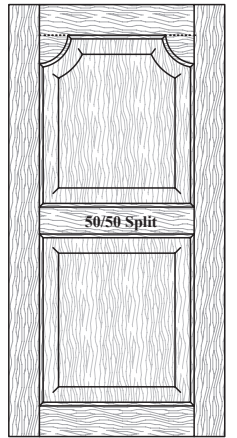

**Style: 2834**

PC: 114  
 Frame: PC114 x 0.6  
 Min. Size: 11<sup>5</sup>/<sub>8</sub>x17<sup>3</sup>/<sub>8</sub>  
 [295.3mm x 441.3mm]

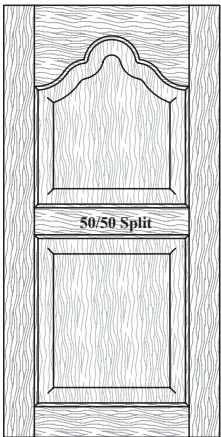

**Style: 2830**

PC: 113  
 Frame: PC113 x 0.6  
 Min. Size: 12x17  
 [304.8mm x 431.8mm]

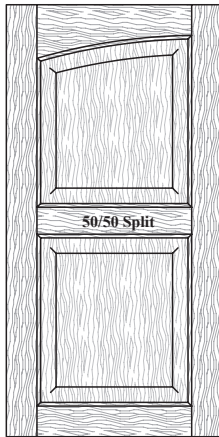

**Style: 2832L**

PC: 105  
 Frame: PC105 x 0.6  
 Min. Size: 8x14<sup>5</sup>/<sub>8</sub>  
 [203.2mm x 371.5mm]

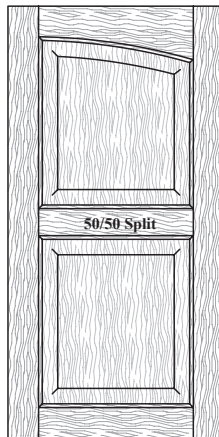

**Style: 2832R**

PC: 105  
 Frame: PC105 x 0.6  
 Min. Size: 8x14<sup>5</sup>/<sub>8</sub>  
 [203.2mm x 371.5mm]

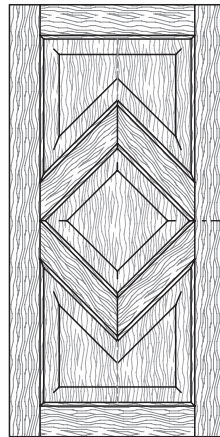

**Style: 2928**

PC: 127  
 Frame: PC127 x 0.6  
 Min. Size: 12x26  
 [304.8mm x 660.4mm]

CL = Center Line of Center Rail

CRP = Center Rail Placement.

B

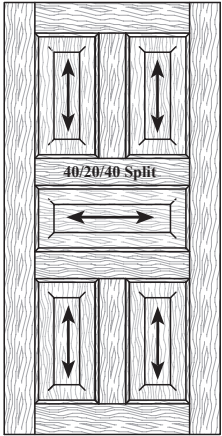

Style: 2465

PC: 136  
Frame: PC136 x 0.6  
Min. Size: 13<sup>3</sup>/<sub>4</sub>x25  
[349.3mm x 635mm]



Style: 2498L

PC: 137  
Frame: PC137 x 0.6  
Min. Size: 8x15<sup>1</sup>/<sub>2</sub>  
[203.2mm x 393.7mm]



Style: 2498R

PC: 137  
Frame: PC137 x 0.6  
Min. Size: 8x15<sup>1</sup>/<sub>2</sub>  
[203.2mm x 393.7mm]



Style: 2501L

PC: 137  
Frame: PC137 x 0.6  
Min. Size: 8x17<sup>1</sup>/<sub>4</sub>  
[203.2mm x 438.2mm]



Style: 2501R

PC: 137  
Frame: PC137 x 0.6  
Min. Size: 8x17<sup>1</sup>/<sub>4</sub>  
[203.2mm x 438.2mm]

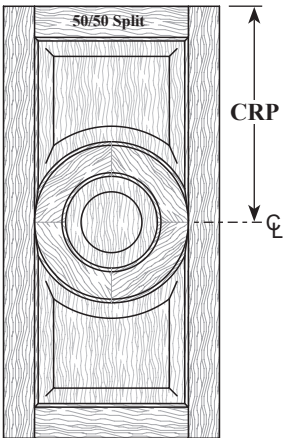

Style: 2156

PC: 127  
Frame: PC127 x 0.6  
Min. Size: 11<sup>3</sup>/<sub>4</sub>x22  
[298.5mm x 558.8mm]

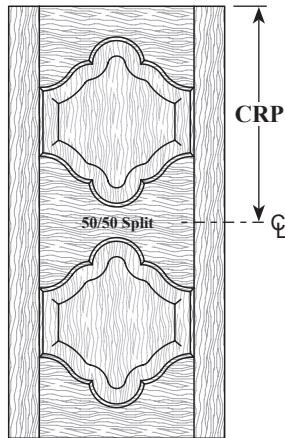

Style: 2456

PC: 135  
Frame: PC135 x 0.6  
Min. Size: 12x26<sup>3</sup>/<sub>4</sub>  
[304.8mm x 679.5mm]

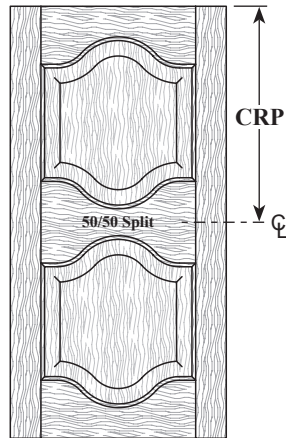

Style: 2424

PC: 116  
Frame: PC116 x 0.6  
Min. Size: 8x20<sup>3</sup>/<sub>4</sub>  
[203.2mm x 527.1mm]

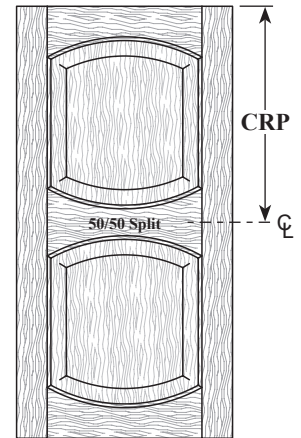

Style: 2171

PC: 116  
Frame: PC116 x 0.6  
Min. Size: 8x20<sup>3</sup>/<sub>4</sub>  
[203.2mm x 527.1mm]

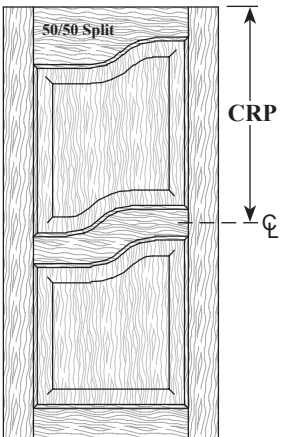

Style: 2563L

PC: 138  
Frame: PC138 x 0.6  
Min. Size: 12x17  
[304.8mm x 431.8mm]

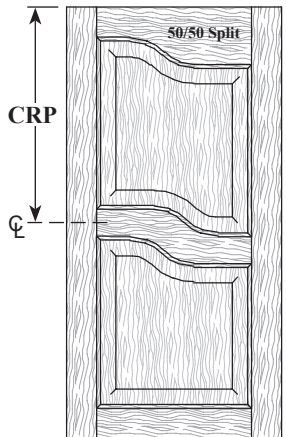

Style: 2563R

PC: 138  
Frame: PC138 x 0.6  
Min. Size: 12x17  
[304.8mm x 431.8mm]

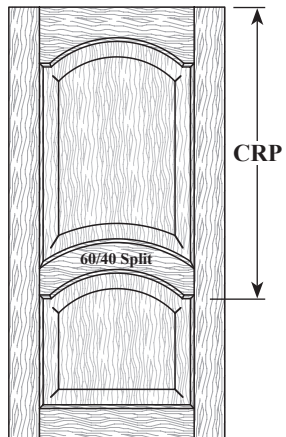

Style: 2287

PC: 138  
Frame: PC138 x 0.6  
Min. Size: 8x15<sup>1</sup>/<sub>2</sub>  
[203.2mm x 403.2mm]

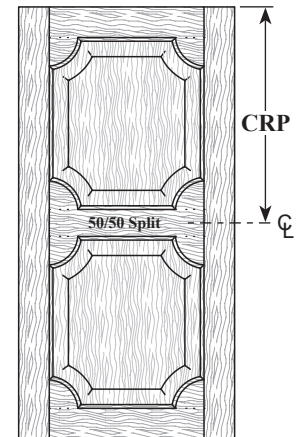

Style: 2416

PC: 129  
Frame: PC129 x 0.6  
Min. Size: 11<sup>5</sup>/<sub>8</sub>x21  
[295.3mm x 533.4mm]

CL = Center Line of Center Rail

CRP = Center Rail Placement.

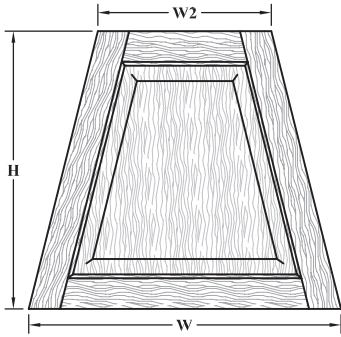

Style: 2234

PC: 122  
 Frame: PC122 x 0.6  
 Min. Size: 8x8  
 [203.2mm x 203.2mm]  
 See Notes for Ordering Information

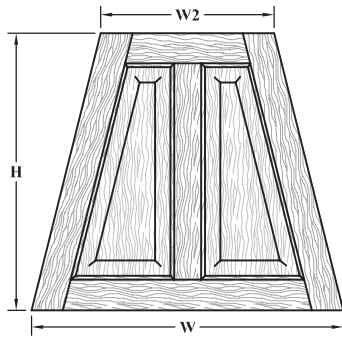

Style: 2235

PC: 126  
 Frame: PC126 x 0.6  
 Min. Size: 13 3/4 x 8  
 [349.3mm x 203.2mm]  
 See Notes for Ordering Information

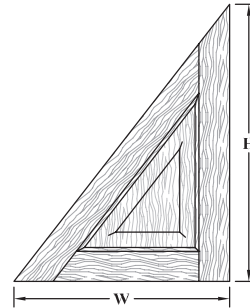

Style: 2231L

PC: 122  
 Frame: PC122 x 0.6  
 Min. Size: 8x8  
 [203.2mm x 203.2mm]  
 See Notes for Ordering Information

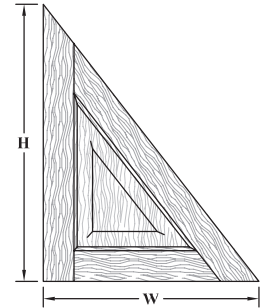

Style: 2231R

PC: 122  
 Frame: PC122 x 0.6  
 Min. Size: 8x8  
 [203.2mm x 203.2mm]  
 See Notes for Ordering Information

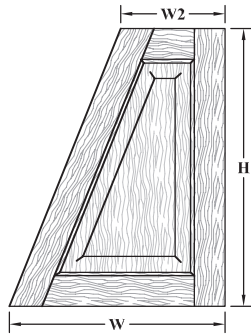

Style: 2232L

PC: 122  
 Frame: PC122 x 0.6  
 Min. Size: 8x8  
 [203.2mm x 203.2mm]  
 See Notes for Ordering Information

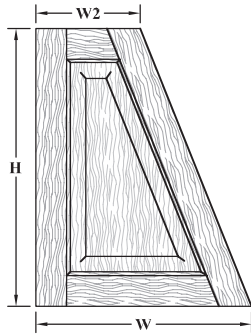

Style: 2232R

PC: 122  
 Frame: PC122 x 0.6  
 Min. Size: 8x8  
 [203.2mm x 203.2mm]  
 See Notes for Ordering Information

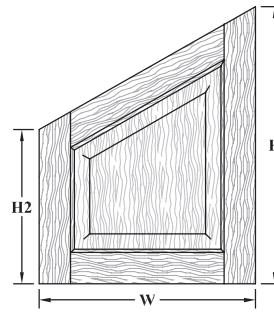

Style: 2284L

PC: 122  
 Frame: PC122 x 0.6  
 Min. Size: 8x8  
 [203.2mm x 203.2mm]  
 See Notes for Ordering Information

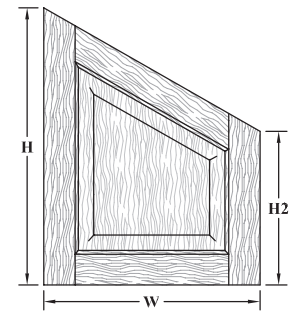

Style: 2284R

PC: 122  
 Frame: PC122 x 0.6  
 Min. Size: 8x8  
 [203.2mm x 203.2mm]  
 See Notes for Ordering Information

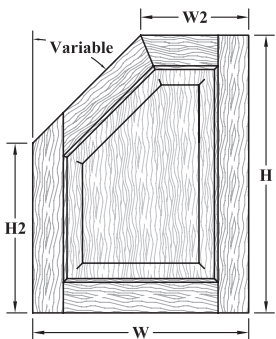

Style: 2631L

PC: 139  
 Frame: PC139 x 0.6  
 Min. Size: 9 3/4 x 9 3/4  
 [247.7mm x 247.7mm]  
 See Notes for Ordering Information

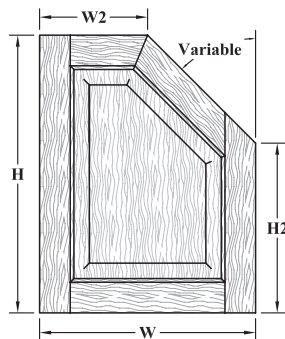

Style: 2631R

PC: 139  
 Frame: PC139 x 0.6  
 Min. Size: 9 3/4 x 9 3/4  
 [247.7mm x 247.7mm]  
 See Notes for Ordering Information

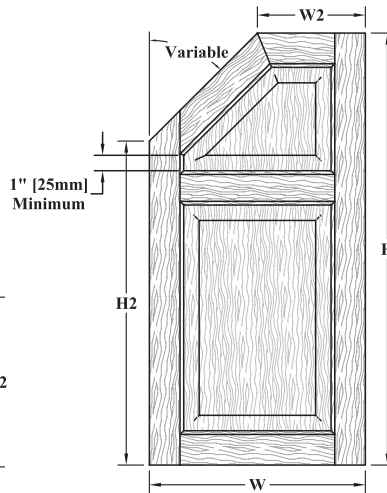

Style: 2289L

PC: 140  
 Frame: PC140 x 0.6  
 Min. Size: 9 3/4 x 13 3/4  
 [247.7mm x 349.3mm]  
 See Notes for Ordering Information

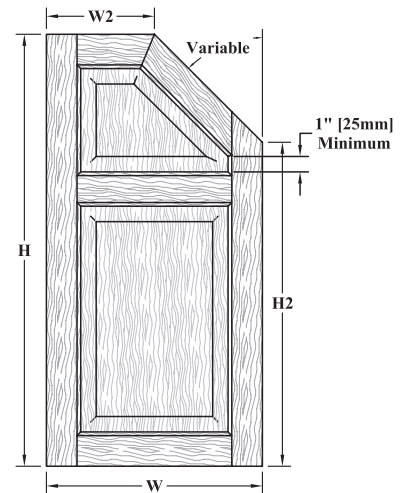

Style: 2289R

PC: 140  
 Frame: PC140 x 0.6  
 Min. Size: 9 3/4 x 13 3/4  
 [247.7mm x 349.3mm]  
 See Notes for Ordering Information

► For PRICING ► See Section B.1 in our current Wholesale Pricing Catalog.

## Cabinet Door & Drawer Front Options

## Traditional Mortise & Tenon - Raised Panel

B



**Style: 2021L**

PC: 125

Frame: PC125 x 0.6

Min. Size: 10x12 $\frac{1}{4}$

[254mm x 311.2mm]

See Notes for Ordering Information

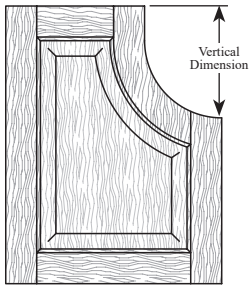

**Style: 2021R**

PC: 125

Frame: PC125 x 0.6

Min. Size: 10x12 $\frac{1}{4}$

[254mm x 311.2mm]

See Notes for Ordering Information

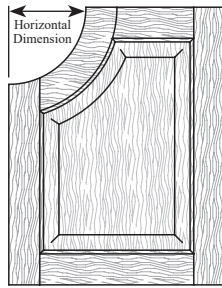

**Style: 3056L**

PC: 125

Frame: PC125 x 0.6

Min. Size: 12x12

[304.8mm x 304.8mm]

See Notes for Ordering Information

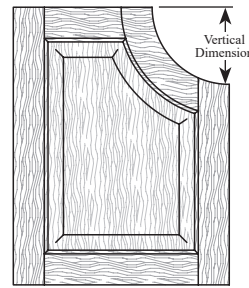

**Style: 3056R**

PC: 125

Frame: PC125 x 0.6

Min. Size: 12x12

[304.8mm x 304.8mm]

See Notes for Ordering Information

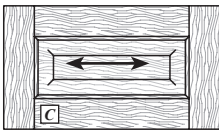

**Style: 10\***  
Drawer Front

PC: 101

Frame: PC101 x 0.6

Min. Size: 8x8

[203.2mm x 203.2mm]

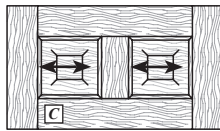

**Style: 1010\***  
Drawer Front

PC: 103

Frame: PC103 x 0.6

Min. Size: 13 $\frac{1}{4}$ x8

[349.3mm x 203.2mm]

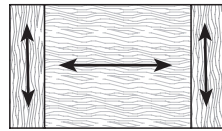

**Style: 1026\***  
Drawer Front

PC: 118

Frame: NA

Min. Size: 6 $\frac{5}{8}$ x3

[168.3mm x 76.2mm]

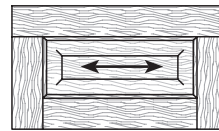

**Style: 1800\***  
Drawer Front

PC: 118

Frame: PC118 x 0.6

Min. Size: 8x8

[203.2mm x 203.2mm]

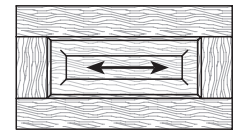

**Style: 1801\***  
Drawer Front

PC: 101

Frame: PC101 x 0.6

Min. Size: 8x8

[203.2mm x 203.2mm]

► For PRICING ► See Section [B.1](#) in our current Wholesale Pricing Catalog.

Ordering & Pricing Notes: Traditional Mortise & Tenon Raised Panel Door and Drawer Fronts

Ordering Guidelines

1	Order Forms	Please use <i>Door and/or Drawer Front Order Forms (E•Z Forms #2 and #3)</i> .
<b>Pricing</b>		
1	Pricing	Please see <i>Section B.1</i> of our current Wholesale Pricing Catalog.

Technical Notes: Traditional Mortise & Tenon Raised Panel Door and Drawer Fronts

Cabinet Door & Drawer Front Options (Chapter B)

1	Frame & Mullion Doors	Glass openings are routed to follow the contour of the shape for Styles <b>1020, 1055, 1060, 1065, 1070, 1075, 1080, 1090, 2011L, 2011R, 2021L, 2021R, 2077L, 2077R, 2100L, 2100R, 2121L, 2121R, 2156, 2187, 2231L, 2231R, 2232L, 2232R, 2234, 2235, 2284L, 2284R, 2287 (Center rail only), 2289L, 2289R, 2416, 2418, 2498L, 2498R, 2501L, 2501R, 2563L, 2563R, 2631L, 2631R, 2834, 2928, 3056L, 3056R</b> . For pricing, please see <i>Section B.12</i> of our current Wholesale Pricing Catalog.
2	Style 1026*	Only available as a drawer front. Only available in solid wood and raw MDF (not available in a hybrid species). Maximum height is 12" [304.8mm]. Heights up to 6" [152.4mm] will be constructed without glue-ups whenever possible. Available with the <b>SR100</b> stile & rail profile from <i>Section E.1</i> or any Mirror Joint stile & rail profile from <i>Section E.2</i> . • When paired with any stile & rail door (ex: Style 10, Style 40, etc.), the door must utilize the same stile & rail profile and have the same width stiles as the <b>1026*</b> drawer front.
3	Style 1055, 1065, 1075	The width of the stiles and rails is fixed at 2¼" [57.2mm] (at the narrowest point). Radius is fixed at 1¾" [44.5mm]. Please submit requests for all other dimensions to our Customer Support Team. • Additional charges will apply.
4	Style 2021L, 2021R	Minimum radius = 2" [50.8mm]. The radius will equal 90 degrees of an arc on the outside edge. The horizontal dimension of the curved stile (as shown in the illustration) equals the radius. <i>These door style illustrations depict a 14" x 18" [355.6mm x 457.2mm] door with a curved stile radius of 5" [127mm].</i> The vertical dimension of the curved stile (as shown in the illustration) equals the radius plus the width of the top rail. <i>Based on the 14" x 18" [355.6mm x 457.2mm] door size illustrated along with the 5" [127mm] radius, this dimension would be 7¼" [184.2mm].</i> When ordering, please provide the overall width and height of the door and note the horizontal dimension (radius) in the <b>Special Instructions</b> column on the order form. <b>A CAD drawing must be approved prior to manufacturing the product.</b>
5	Style 2156	Width cannot be greater than the height. • Minimum visual opening width for center circle is 7¼" [184.2mm]. Minimum height must be 2 times the width minus 4" [101.6mm]. Available with all "Traditional" and Old World "Traditional" stile and rail profiles. The center panel is ¾" [15.9mm] thick and is flush to the stiles & rails on the face and recessed ¼" [3.2mm] from the back. When ordered in a rustic grade, the center rail/circle will not have large knots. It may contain small knots or possibly, no knots at all. WalzCraft will try to maintain a rustic grade look utilizing other characteristics. See <i>Section S.1</i> for more information on rustic grades. <b>A CAD drawing must be approved prior to manufacturing the product.</b>
6	Style 2231L, 2231R	Please provide overall width (W) and height (H). Angles will vary as dimensions vary. <b>A CAD drawing must be approved prior to manufacturing the product.</b>
7	Style 2232L, 2232R, 2234	Please provide overall width (W) and height (H), as well as the secondary width (W2) at the top of door. Angles will vary as dimensions vary. <b>A CAD drawing must be approved prior to manufacturing the product.</b>
8	Style 2235	Please provide overall width (W) and height (H), as well as the secondary width (W2) at the top of door. Angles will vary as dimensions vary. Center stile will be centered on width (50/50 split), unless otherwise noted. <b>A CAD drawing must be approved prior to manufacturing the product.</b>

Continued on next page...

► For PRICING ► See Section **B.1** in our current Wholesale Pricing Catalog.

**Technical Notes: "Traditional" Mortise & Tenon Raised Panel Door and Drawer Fronts...continued**

**Cabinet Door & Drawer Front Options (Chapter B)...continued**

9	Style 2284L, 2284R	Please provide overall width (W) and height (H), as well as the secondary height (H2) along the side of door.
		Angles will vary as dimensions vary.
		<b>A CAD drawing must be approved prior to manufacturing the product.</b>
10	Style 2289L, 2289R	Please provide overall width (W) and height (H), as well as the secondary width (W2) at the top of door and the secondary height (H2) at the side of the door.
		Angle will vary as dimensions vary.
		Center rail is shown at its highest point, which is also its standard placement, unless otherwise noted. <b>A CAD drawing must be approved prior to manufacturing the product.</b>
11	Style 2631L, 2631R	Please provide overall width (W) and height (H), as well as the secondary width (W2) at the top of door and the secondary height (H2) at the side of the door.
		Angle will vary as dimensions vary.
		<b>A CAD drawing must be approved prior to manufacturing the product.</b>
12	Style 2928	Overall width of door and stile & rail width will determine size of interior diamond.
		Sides of interior diamond will remain equal in length to one another.
		Angles are fixed at 45°. <b>A CAD drawing must be approved prior to manufacturing the product.</b>
13	Style 3056L & 3056R	Minimum radius = 2" [50.8mm]. The radius will equal 90 degrees of an arc on the outside edge.
		The horizontal dimension of the curved rail (as shown in the illustration) equals the radius. <i>These door style illustrations depict a 14" x 18" [355.6mm x 457.2mm] door with a curved stile radius of 5" [127mm].</i>
		The vertical dimension of the curved rail (as shown in the illustration) equals the radius. <i>These door style illustrations depict a 14" x 18" [355.6mm x 457.2mm] door with a curved stile radius of 5" [127mm].</i>
		When ordering, please provide the overall width and height of the door and note the horizontal dimension (radius) in the <b>Special Instructions</b> column on the order form. <b>A CAD drawing must be approved prior to manufacturing the product.</b>
14	Style 8060	Style 8060 is constructed with alternating 40/60 splits.
15	Style 8160	Style 8160 is constructed with a 50/50 split in both the width and height.

**Convex/Concave Options (Chapter D)**

1	Available Products	The <input type="checkbox"/> indicates door styles that are available convex/concave (curved). See <b>Chapter D</b> for more information.
2	Raw MDF	Traditional mortise & tenon doors and drawer fronts made from <b>MDF</b> or <b>MDF-MR</b> are not available convex/concave.

**Finish Options (Chapter R)**

1	Raw MDF	See Finishing Methods ( <b>Section R.2</b> ) for information on <b>MDF</b> or <b>MDF-MR</b> with Primed Only for Paint or SolidTone® colors.
		Traditional mortise & tenon doors and drawer fronts made from <b>MDF</b> or <b>MDF-MR</b> are not available with 3D Laminate.

*Continued on next page...*

► For PRICING ► See Section **B.1** in our current Wholesale Pricing Catalog.

Technical Notes: "Traditional" Mortise & Tenon Raised Panel Door and Drawer Fronts...continued

Functional Options (Chapter F)

1	Finger Pulls	Available with FP100, FP200, FP400 and FP500 from <i>Section F.7</i> .
		Please see the <b>Outside Edge Profile Compatibility</b> chart on our website: <b>Resources/Technical Information</b> .
2	Hinge Boring	Hinge boring is available for all "Traditional" Mortise & Tenon - Raised Panel doors and drawer fronts. Please see <i>Section F.1</i> for additional hinge boring requirements, ordering instructions and compatibility.

General Information (Chapter A)

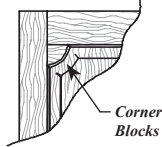
1	Grain Direction	Arrows (←→) shown indicate standard grain direction. Grain direction may be specified at <b>NO</b> additional cost.
		<p><i>Corner blocks</i> on all applicable door styles (ex: <b>Style 1080</b>) will have a standard <i>horizontal</i> grain direction.</p> 
2	Ready to Assemble	Traditional mortise & tenon raised panel doors and drawer fronts are available Ready to Assemble (RTA).
3	Center Rail Placement	Custom center rail placement may be specified and refers to the distance from the top of the top rail to the top of the center rail for most door styles ( <i>see below for exceptions</i> ).
		<b>Styles 2156, 2424, 2171, 2416, 2456, 2928:</b> For custom rail placement, measure from the top of the door to the center of the center rail.
		<b>Styles 2563L, 2563R:</b> For custom rail placement, measure from the top of the door to the center of the center rail at its highest point.
		<b>Style 2287:</b> For custom rail placement, measure from the top of the door to the bottom of the center rail at its lowest point.
See <b>Center Rail Placement</b> in <i>Section A.4</i> for more information.		
4	Stile & Rail Dimensions	Standard stile and rail dimensions are 2¼" [57.2mm] wide. Non-standard part sizes may be ordered, however, additional up-charges may apply. See <i>Section A.5</i> for more information.

Material Options

1	Materials Available	Available in all of the species/grades noted in <i>Section B.1</i> of our current <b>Wholesale Pricing Catalog</b> . • See individual door style notes for exceptions.
2	Door Style 2156 Hybrid/MDF	When ordering door style <b>2156</b> in <b>Hybrid/MDF</b> (solid wood stiles & rails with raw <b>MDF</b> center panel), the center rail/circle will be made from raw <b>MDF</b> for SolidTone® or Primed Only for Paint applications.

Molding Options (Chapter N)

1	Applied Moldings on MDF	When an applied molding is added to an <b>MDF</b> product, the molding will be made from Maple - Hard/Soft Mixed Value/Budget/Paint Grade.
---	-------------------------	--

Profile Options (Chapter E)

1	Door Styles 25, 2550, 2727, 2826	When adding an applied molding to the stiles and rails of these door styles, the molding for the arched rails will be made from two pieces, so as to have a miter joint at the peak of the arch.
---	----------------------------------	--

Continued on next page...

► For PRICING ► See Section B.1 in our current Wholesale Pricing Catalog.

*Technical Notes: "Traditional" Mortise & Tenon Raised Panel Door and Drawer Fronts...continued*

**Sizes/Dimensions**

<b>1</b>	<b>Minimum W x H</b>	Use the dimensions noted below the image of your chosen door style on the preceding pages.
<b>2</b>	<b>Thicknesses</b>	When using Traditional stile and rail profiles, Traditional Mortise & Tenon raised panel doors and DFs made from solid wood are available ¾" [19.3mm] and 1" [25.4mm] thick.
		When using Old World stile and rail profiles, Traditional Mortise & Tenon raised panel doors and DFs made from solid wood are available 1" [25.4mm], 1⅝" [28.6mm] and 1¼" [31.8mm] thick.
		See <b>Section S.3</b> for possible thickness restrictions based on wood species.
		Traditional mortise & tenon raised panel doors and DFs made from raw <b>MDF</b> are available ¾" [19.1mm] and 1" [25.4mm] thick.
<b>3</b>	<b>MDF Maximum Size</b>	Traditional mortise & tenon raised panel doors and DFs made from raw <b>MDF-MR</b> are only available ¾" [19.1mm] thick.
		Old World mortise & tenon raised panel doors and DFs made from raw <b>MDF</b> are only available 1" [25.4mm] thick.
<b>4</b>	<b>Maximum Width for Doors with Shaped Rails</b>	<p>The maximum size for a Traditional mortise &amp; tenon door made from raw <b>MDF</b> or <b>MDF-MR</b> will be 48" x 96" [1219.2mm x 2438.4mm] or 96" x 48" [2438.4mm x 1219.2mm].</p> <p>The maximum width for a WalzCraft standard door with a shaped rail or rails is 30" [762.0mm] - (based on 2¼" [57.2mm] wide stiles).</p> <ul style="list-style-type: none"> <li>• Please submit requests for doors with shaped rails over 30" wide to our Customer Support Team, as additional charges may apply.</li> <li>• This does not include doors made with corner blocks (Price Classes 107, 111, 114, 121, 124, 128, 129).</li> </ul>

**Traditional Mortise & Tenon Raised Panel Doors and Drawer Fronts - END**

► For PRICING ► See Section **B.1** in our current Wholesale Pricing Catalog.

Quarter Circle Doors - Raised Panel

B

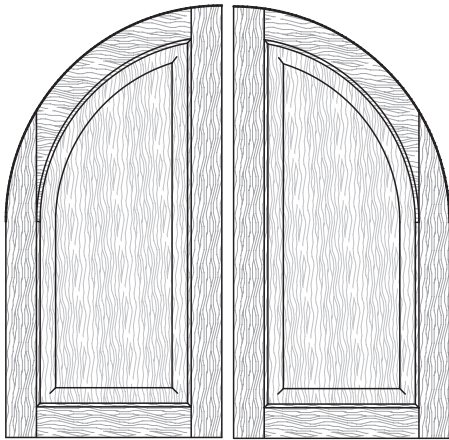

Style: 995L

PC: 906  
 Frame: PC906 x 0.6  
 Min. Size: 8x11½  
 [203.2mm x 292.1mm]  
 Outside Radius

Style: 995R

PC: 906  
 Frame: PC906 x 0.6  
 Min. Size: 8x11½  
 [203.2mm x 292.1mm]  
 Outside Radius

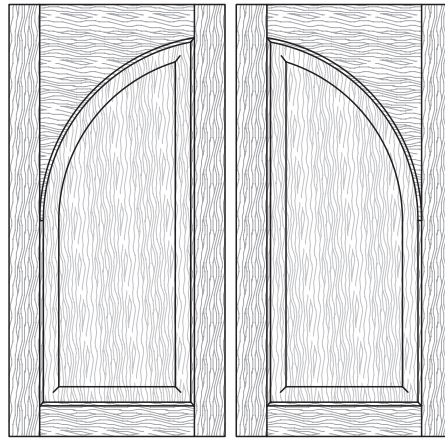

Style: 996L

PC: 905  
 Frame: PC905 x 0.6  
 Min. Size: 8x11½  
 [203.2mm x 292.1mm]  
 Outside Radius

Style: 996R

PC: 905  
 Frame: PC905 x 0.6  
 Min. Size: 8x11½  
 [203.2mm x 292.1mm]  
 Outside Radius



Style: 2431L

PC: 907  
 Frame: PC907 x 0.6  
 Min. Size: 8x16¼  
 [203.2mm x 412.8mm]  
 Outside Radius

Style: 2431R

PC: 907  
 Frame: PC907 x 0.6  
 Min. Size: 8x16¼  
 [203.2mm x 412.8mm]  
 Outside Radius

Quarter Circle Radius Explanation

The difference between Outside & Inside Radius

All *Outside Radius* doors feature a radius that is measured from the *outside edge* of the door stile.

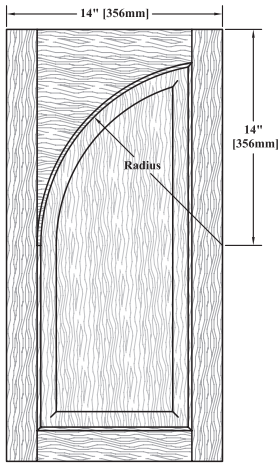

To Calculate Radius Center Point:

**From door width,**  
 Measure down from the top of the door and mark the radius center point on the outside edge of the stile.

All *Inside Radius* doors feature a radius that is measured from the *inside edge* of the door stile.

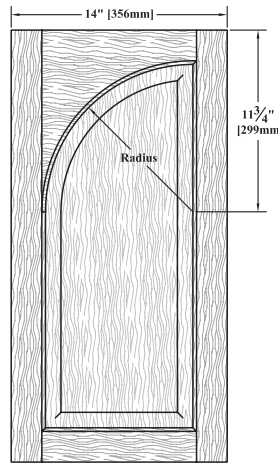

To Calculate Radius Center Point:

**Door width minus the Stile Width: 2¼" [57.2mm],**  
 Measure down from the top of the door and mark the radius center point on the inside edge of the stile.

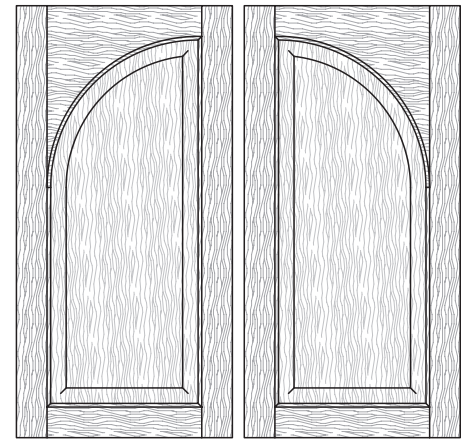

Style: 997L

PC: 905  
 Frame: PC905 x 0.6  
 Min. Size: 8x9¼  
 [203.2mm x 235mm]  
 Inside Radius

Style: 997R

PC: 905  
 Frame: PC905 x 0.6  
 Min. Size: 8x9¼  
 [203.2mm x 235mm]  
 Inside Radius

► For PRICING ► See Section B.2 in our current Wholesale Pricing Catalog.



Half Circle Doors - Raised Panel

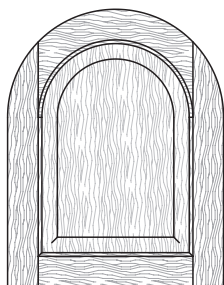

Style: 1990

PC: 906  
 Frame: PC906 x 0.6  
 Min. Size: 9x8  
 [228.6mm x 203.2mm]

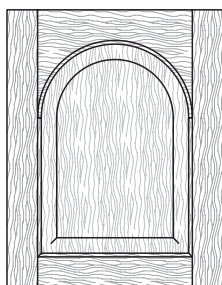

Style: 1996

PC: 905  
 Frame: PC905 x 0.6  
 Min. Size: 9x8  
 [228.6mm x 203.2mm]

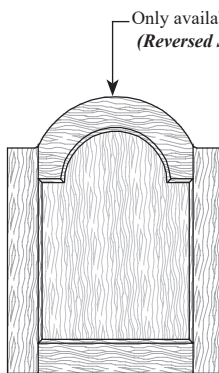

Style: 2903

PC: 906  
 Frame: PC906 x 0.6  
 Min. Size: 12x12  
 [304.8mm x 304.8mm]

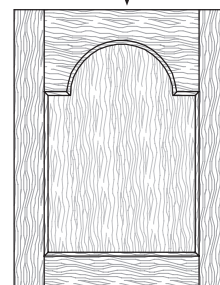

Style: 2902

PC: 905  
 Frame: PC905 x 0.6  
 Min. Size: 12x12  
 [304.8mm x 304.8mm]

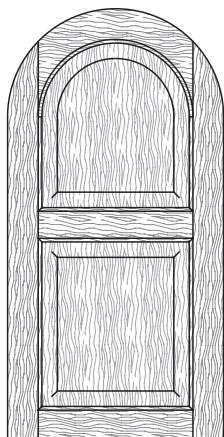

Style: 2960

PC: 909  
 Frame: PC909 x 0.6  
 Min. Size: 9x13  
 [228.6mm x 330.2mm]

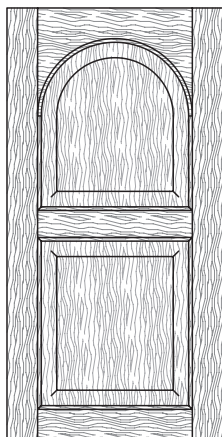

Style: 2962

PC: 908  
 Frame: PC908 x 0.6  
 Min. Size: 9x13  
 [228.6mm x 330.2mm]

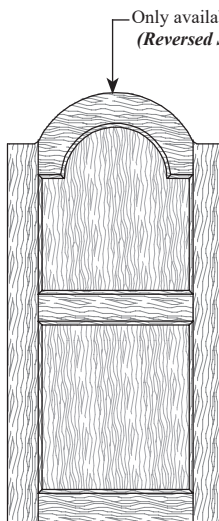

Style: 2964

PC: 909  
 Frame: PC909 x 0.6  
 Min. Size: 12x17  
 [304.8mm x 431.8mm]

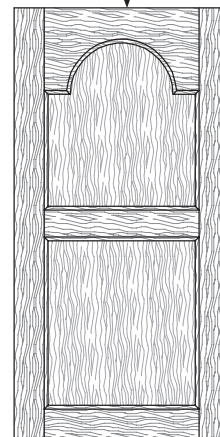

Style: 2966

PC: 908  
 Frame: PC908 x 0.6  
 Min. Size: 12x17  
 [304.8mm x 431.8mm]

Ordering & Pricing Notes: Quarter & Half Circle Doors - Raised Panel

Ordering Guidelines

1	Order Forms	Please use <i>Door Order Form (E•Z Form #2)</i> .
<b>Pricing</b>		
1	Pricing	Please see <i>Section B.2</i> of our current Wholesale Pricing Catalog.

Continued on next page...

► For PRICING ► See Section B.2 in our current Wholesale Pricing Catalog.

**Technical Notes: Quarter & Half Circle Doors - Raised Panel**

**Cabinet Door & Drawer Front Options (Chapter B)**

1	Frame & Mullion Doors	Glass openings are routed to follow the contour of the shape for Styles 995L, 995R, 996L, 996R, 997L, 997R, 1990, 1996, 2431L, 2431R, 2902, 2903, 2960, 2962, 2964, 2966. For pricing, please see <i>Section B.12</i> of our current Wholesale Pricing Catalog.
2	Radius Explanation	See beginning of this section (B.2) for an explanation of <b>Inside</b> and <b>Outside</b> radius door measurements.
3	Styles 2902, 2966	Available with all "Traditional" and Old World "Traditional" Stile and Rail profiles.
		Available with all Outside Edge Profiles. <b>A CAD drawing must be approved prior to manufacturing the product.</b>
4	Style 2903, 2964	Available with all "Traditional" and Old World "Traditional" Stile and Rail profiles.
		Only available with the following Outside Edge Profiles: D7, D12, D15, D17, D18, D21, D24, D32, D41, D52, D67, D93, D101, D102, D115, D118, D120.
		<b>A CAD drawing must be approved prior to manufacturing the product.</b>
5	Center Rail Placement	Center rail placement must be specified and refers to the distance from the top of the top rail to the top of the center rail for most door styles. See Center Rail Placement in <i>Section A.4</i> for more information.

**Functional Options (Chapter F)**

1	Hinge Boring	Hinge boring is available for all Quarter & Half Circle - Raised Panel doors. Please see <i>Section F.1</i> for additional hinge boring requirements, ordering instructions and compatibility.
---	--------------	--

**General Information (Chapter A)**

1	Ready to Assemble (RTA)	RTA is <i>not</i> available as an option.
---	-------------------------	---

**Profile Options (Chapter E)**

1	Stile & Rail Profile Options	Compatible with all "Traditional" and "Old World" stile and rail profiles (excluding Mirror Joints).
2	Style 2902, 2903, 2964, 2966	Only available with the RVSCP-PR324 reverse solid center panel profile ( <i>Section E.13</i> ).

**Sizes/Dimensions**

1	Door Widths	Styles 995L/R, 996L/R, 997L/R, 1990, 1996, 2431L/R, 2960 and 2962 widths can only be ordered in ¼" [6.4mm] increments.
		Styles 2902, 2903, 2964 and 2966 are available from 12" [304.8mm] to 24" [609.6mm] wide in 1" [25.4mm] increments only.
2	Outside Radius	Style 995L, 995R, 996L, 996R: The height must be at least 2¼" [57.2mm] greater than the width.
		Style 2431L, 2431R: The height must be at least two times the width of the door.
3	Inside Radius	Height must be equal to or greater than the width.
4	Half Circle Doors	Width must be less than or equal to the door height, less the width of the (bottom rail x 2).
		Height must be greater than or equal to ½ of the door width, plus the width of the bottom rail and center rail (if applicable).
5	Stile & Rail Widths	<ul style="list-style-type: none"> <li>Traditional Quarter and Half Circle doors will have stile/rail width fixed at 2¼" [57.2mm] wide.</li> <li>Old World Quarter and Half Circle doors will have stile/rail width fixed at 3" [76.2mm] wide.</li> <li>Please submit requests for other widths to our Customer Support Team as additional charges may apply.</li> </ul>
6	Thicknesses	When using Traditional stile and rail profiles, Quarter Circle and Half Circle raised panel doors made from solid wood are available ¾" [19.3mm] and 1" [25.4mm] thick.
		When using Old World stile and rail profiles, Quarter Circle and Half Circle raised panel doors made from solid wood are available 1" [25.4mm], 1½" [28.6mm] and 1¾" [31.8mm] thick.
		See <i>Section S.3</i> for possible thickness restrictions based on wood species.

**Quarter & Half Circle Raised Panel Doors - END**

► For PRICING ► See Section B.2 in our current Wholesale Pricing Catalog.

Gothic Doors - Raised Panel

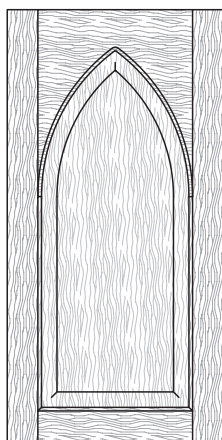

**Style: 9100**  
 PC: 905  
 Frame: PC905 x 0.6  
 Min. Size: 10x11  
 [254mm x 279.4mm]

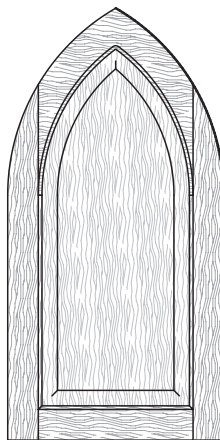

**Style: 9200**  
 PC: 906  
 Frame: PC906 x 0.6  
 Min. Size: 10x11  
 [254mm x 279.4mm]

**Ordering & Pricing Notes: Gothic Doors - Raised Panel**

**Ordering Guidelines**

1	Order Forms	Please use <i>Door Order Form (E•Z Form #2)</i> .
---	-------------	---

**Pricing**

1	Pricing	Please see <i>Section B.2</i> of our current <b>Wholesale Pricing Catalog</b> .
---	---------	---

**Technical Notes: Gothic Doors - Raised Panel**

**Cabinet Door & Drawer Front Options (Chapter B)**

1	Frame & Mullion Doors	Glass openings will be routed to follow the contour of the shape for Styles <b>9100</b> and <b>9200</b> . For pricing, please see <i>Section B.12</i> of our current <b>Wholesale Pricing Catalog</b> .
---	-----------------------	---

**Functional Options (Chapter F)**

1	Hinge Boring	Hinge boring is available for all Gothic - Raised Panel doors. Please see <i>Section F.1</i> for additional hinge boring requirements, ordering instructions and compatibility.
---	--------------	---

**Profile Options (Chapter E)**

1	Stile & Rail Profile Options	Compatible with all “Traditional” and “Old World” stile and rail profiles (excluding Mirror Joints). Mitered Stile and Rail profiles are <u>not</u> an option for Gothic doors.
---	------------------------------	--

**Sizes/Dimensions**

1	Minimum Height	Minimum height equals door width plus 1" [25.4mm].
2	Absolute Minimum Width	The absolute minimum width for a raised panel Gothic door is 10" [254.0mm].
3	Top Rail Width	In order to maintain the “look” and shape of the Gothic arch, the width of the top rail at the peak of the arch will vary slightly from the width of the remaining stiles and rail. This dimension will also fluctuate based on the overall width of the door. If needing to specify this dimension, please submit your request to our Customer Support Team.
4	Thicknesses	When using Traditional stile and rail profiles, Gothic raised panel doors made from solid wood are available ¾" [19.3mm] and 1" [25.4mm] thick. When using Old World stile and rail profiles, Gothic raised panel doors made from solid wood are available 1" [25.4mm], 1¼" [28.6mm] and 1½" [31.8mm] thick. See <i>Section S.3</i> for possible thickness restrictions based on wood species.

**Gothic Raised Panel Doors - END**

► For PRICING ► See *Section B.2* in our current Wholesale Pricing Catalog.





**Cabinet Door & Drawer Front Options**

**Traditional Mortise & Tenon - 1/4" Flat Panel**

**B**

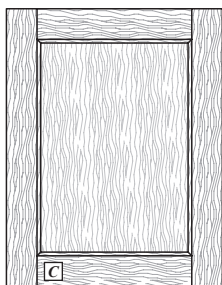

**Style: 40**

PC: 201  
 Frame: PC101 x 0.6  
 Min. Size: 6"x6"  
 [168.3mm x 152.4mm]

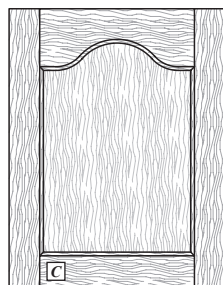

**Style: 30**

PC: 202  
 Frame: PC102 x 0.6  
 Min. Size: 6"x7 1/4"  
 [168.3mm x 196.9mm]

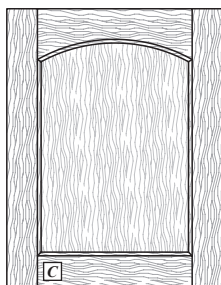

**Style: 3000**

PC: 202  
 Frame: PC102 x 0.6  
 Min. Size: 6"x7 1/4"  
 [168.3mm x 196.9mm]

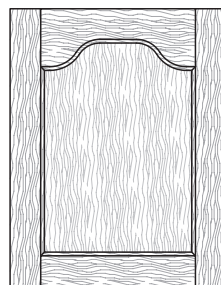

**Style: 2220**

PC: 202  
 Frame: PC102 x 0.6  
 Min. Size: 6"x7 1/4"  
 [168.3mm x 196.9mm]

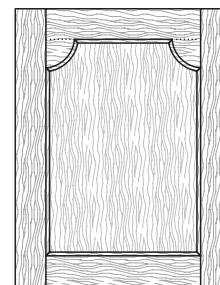

**Style: 4090**

PC: 207  
 Frame: PC107 x 0.6  
 Min. Size: 9"x7 13/16"  
 [244.5mm x 198.4mm]

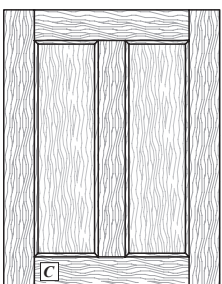

**Style: 4040**

PC: 203  
 Frame: PC103 x 0.6  
 Min. Size: 9"x6"  
 [247.7mm x 168.3mm]

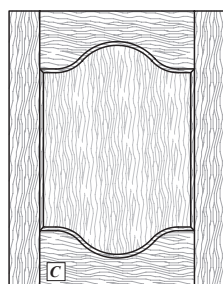

**Style: 3030**

PC: 206  
 Frame: PC106 x 0.6  
 Min. Size: 6"x9 1/2"  
 [263.5mm x 241.3mm]

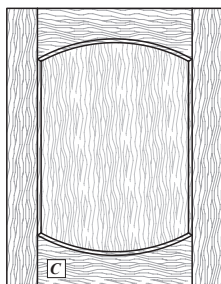

**Style: 5000**

PC: 206  
 Frame: PC106 x 0.6  
 Min. Size: 6"x9 1/2"  
 [168.3mm x 241.3mm]

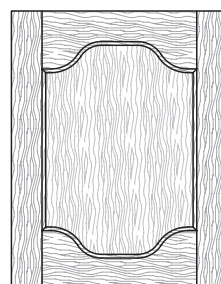

**Style: 2230**

PC: 206  
 Frame: PC106 x 0.6  
 Min. Size: 6"x9 1/2"  
 [294.5mm x 241.3mm]

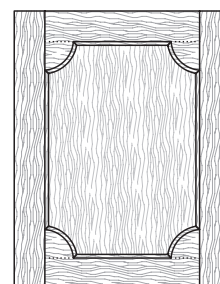

**Style: 4080**

PC: 211  
 Frame: PC111 x 0.6  
 Min. Size: 9"x9 5/8"  
 [244.5mm x 244.5mm]

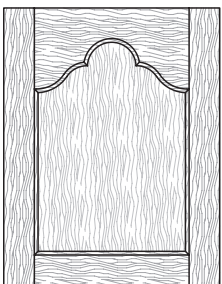

**Style: 7020**

PC: 204  
 Frame: PC104 x 0.6  
 Min. Size: 12x11  
 [304.8mm x 279.4mm]

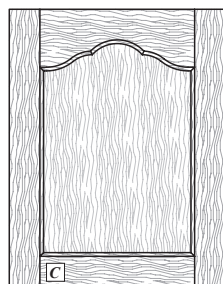

**Style: 3500**

PC: 202  
 Frame: PC102 x 0.6  
 Min. Size: 6"x6 1/4"  
 [168.3mm x 158.8mm]

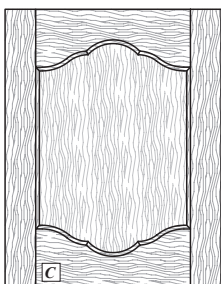

**Style: 3535**

PC: 206  
 Frame: PC106 x 0.6  
 Min. Size: 6"x9 1/2"  
 [168.3mm x 241.3mm]

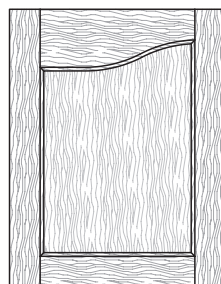

**Style: 2071L**

PC: 202  
 Frame: PC102 x 0.6  
 Min. Size: 6"x7 1/4"  
 [168.3mm x 196.9mm]

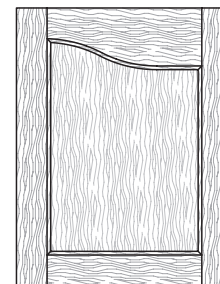

**Style: 2071R**

PC: 202  
 Frame: PC102 x 0.6  
 Min. Size: 6"x7 1/4"  
 [168.3mm x 196.9mm]

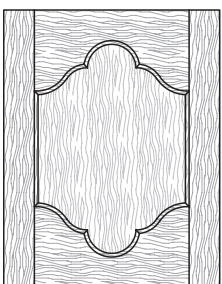

**Style: 7030**

PC: 209  
 Frame: PC109 x 0.6  
 Min. Size: 12x12 1/2  
 [304.8mm x 317.5mm]

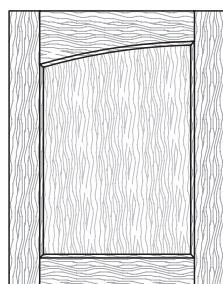

**Style: 2002L**

PC: 202  
 Frame: PC102 x 0.6  
 Min. Size: 6"x7 1/4"  
 [168.3mm x 196.9mm]

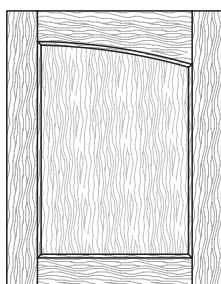

**Style: 2002R**

PC: 202  
 Frame: PC102 x 0.6  
 Min. Size: 6"x7 1/4"  
 [168.3mm x 196.9mm]

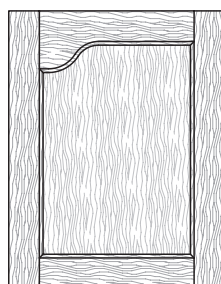

**Style: 2202L**

PC: 202  
 Frame: PC102 x 0.6  
 Min. Size: 6"x7 1/4"  
 [168.3mm x 196.9mm]

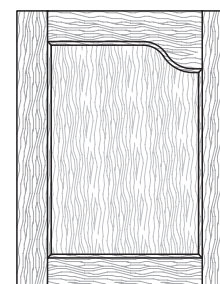

**Style: 2202R**

PC: 202  
 Frame: PC102 x 0.6  
 Min. Size: 6"x7 1/4"  
 [168.3mm x 196.9mm]

► **For PRICING** ► See Section **B.3** in our current Wholesale Pricing Catalog.



**Traditional Mortise & Tenon - 1/4" Flat Panel**

**Cabinet Door & Drawer Front Options**

**B**

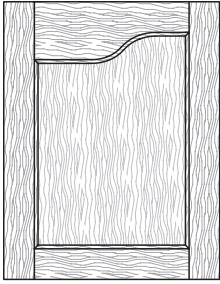

**Style: 3800L**

PC: 202  
 Frame: PC102 x 0.6  
 Min. Size: 12x7 1/4  
 [304.8mm x 196.9mm]

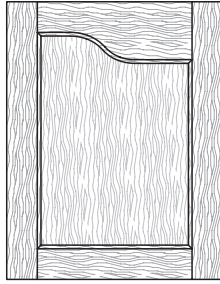

**Style: 3800R**

PC: 202  
 Frame: PC102 x 0.6  
 Min. Size: 12x7 1/4  
 [304.8mm x 196.9mm]

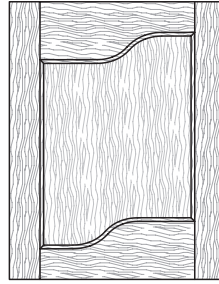

**Style: 3838L**

PC: 206  
 Frame: PC106 x 0.6  
 Min. Size: 12x9 5/8  
 [304.8mm x 244.5mm]

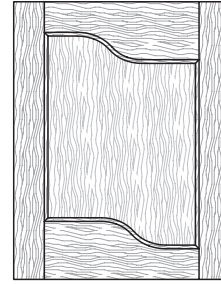

**Style: 3838R**

PC: 206  
 Frame: PC106 x 0.6  
 Min. Size: 12x9 5/8  
 [304.8mm x 244.5mm]

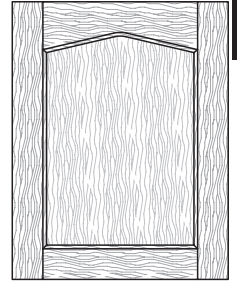

**Style: 31**

PC: 202  
 Frame: PC102 x 0.6  
 Min. Size: 6 5/8 x 6 3/16  
 [168.3mm x 157.2mm]

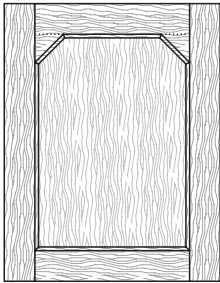

**Style: 4060**

PC: 207  
 Frame: PC107 x 0.6  
 Min. Size: 9 5/8 x 7 13/16  
 [244.5mm x 198.4mm]

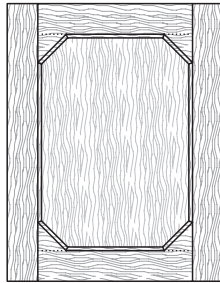

**Style: 4070**

PC: 211  
 Frame: PC111 x 0.6  
 Min. Size: 9 5/8 x 9 5/8  
 [244.5mm x 244.5mm]

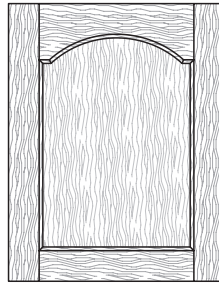

**Style: 3005**

PC: 202  
 Frame: PC102 x 0.6  
 Min. Size: 6 5/8 x 6 5/16  
 [168.3mm x 160.3mm]

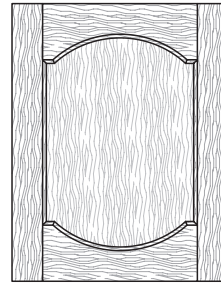

**Style: 3055**

PC: 206  
 Frame: PC106 x 0.6  
 Min. Size: 6 5/8 x 9 1/2  
 [168.3mm x 241.3mm]

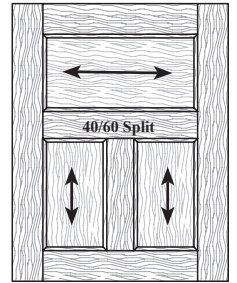

**Style: 3010**

PC: 231  
 Frame: PC131 x 0.6  
 Min. Size: 9 5/8 x 11 1/4  
 [247.7mm x 285.8mm]

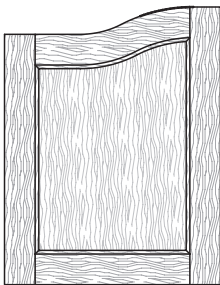

**Style: 2072L**

PC: 223  
 Frame: PC123 x 0.6  
 Min. Size: 6 5/8 x 7 3/4  
 [168.3mm x 196.9mm]

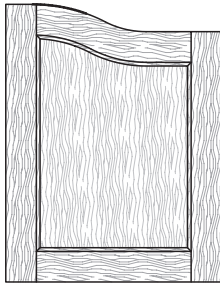

**Style: 2072R**

PC: 223  
 Frame: PC123 x 0.6  
 Min. Size: 6 5/8 x 7 3/4  
 [168.3mm x 196.9mm]

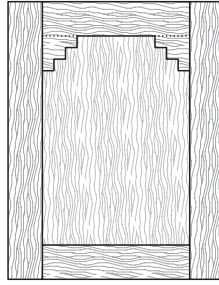

**Style: 4050**

PC: 207  
 Frame: PC107 x 0.6  
 Min. Size: 10 1/2 x 8 3/4  
 [266.7mm x 209.6mm]

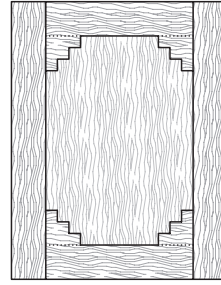

**Style: 4055**

PC: 211  
 Frame: PC111 x 0.6  
 Min. Size: 10 1/2 x 10 1/2  
 [266.7mm x 266.7mm]

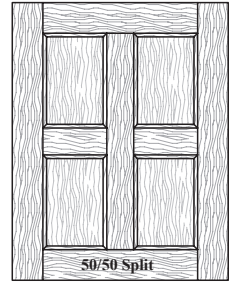

**Style: 3160**

PC: 215  
 Frame: PC115 x 0.6  
 Min. Size: 11 x 9 3/4  
 [279.4mm x 247.7mm]

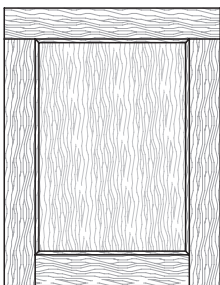

**Style: 1400**

PC: 218  
 Frame: PC118 x 0.6  
 Min. Size: 6 5/8 x 6  
 [168.3mm x 152.4mm]

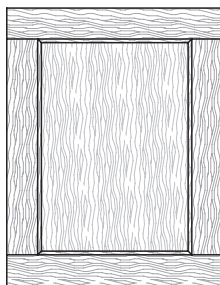

**Style: 1401**

PC: 201  
 Frame: PC101 x 0.6  
 Min. Size: 6 x 6 5/8  
 [152.4mm x 168.3mm]

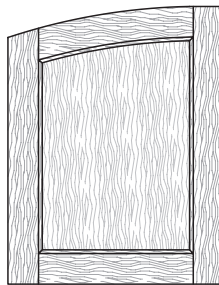

**Style: 2012L**

PC: 223  
 Frame: PC123 x 0.6  
 Min. Size: 6 5/8 x 7 3/4  
 [168.3mm x 196.9mm]

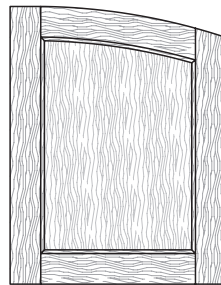

**Style: 2012R**

PC: 223  
 Frame: PC123 x 0.6  
 Min. Size: 6 5/8 x 7 3/4  
 [168.3mm x 196.9mm]

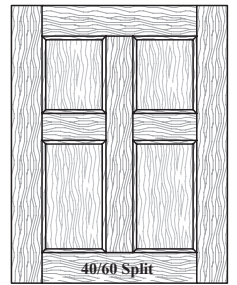

**Style: 3170**

PC: 215  
 Frame: PC115 x 0.6  
 Min. Size: 11 x 11 1/2  
 [279.4mm x 292.1mm]

► **For PRICING** ► See Section **B.3** in our current Wholesale Pricing Catalog.

**Cabinet Door & Drawer Front Options**

**Traditional Mortise & Tenon - 1/4" Flat Panel**

**B**

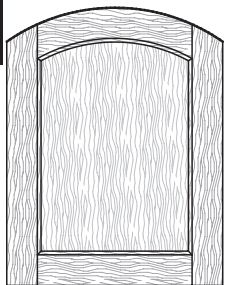

**Style: 3187**

PC: 223  
 Frame: PC123 x 0.6  
 Min. Size: 6<sup>5</sup>/<sub>8</sub>x7<sup>3</sup>/<sub>4</sub>  
 [168.3mm x 196.9mm]

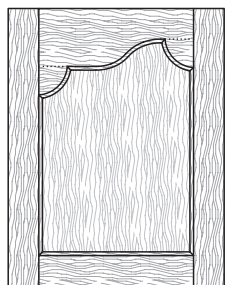

**Style: 3100L**

PC: 221  
 Frame: PC121 x 0.6  
 Fixed Min: 12x9<sup>3</sup>/<sub>8</sub>  
 [304.8mm x 231.8mm]

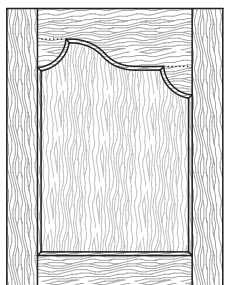

**Style: 3100R**

PC: 221  
 Frame: PC121 x 0.6  
 Fixed Min: 12x9<sup>3</sup>/<sub>8</sub>  
 [304.8mm x 231.8mm]

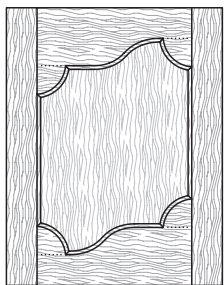

**Style: 3131L**

PC: 224  
 Frame: PC124 x 0.6  
 Fixed Min: 12x10<sup>7</sup>/<sub>8</sub>  
 [304.8mm x 276.2mm]

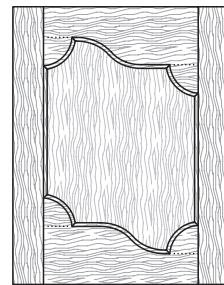

**Style: 3131R**

PC: 224  
 Frame: PC124 x 0.6  
 Fixed Min: 12x10<sup>7</sup>/<sub>8</sub>  
 [304.8mm x 276.2mm]

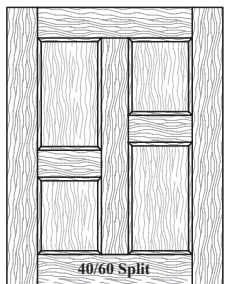

**Style: 3060L**

PC: 232  
 Frame: PC132 x 0.6  
 Min. Size: 11x11<sup>1</sup>/<sub>4</sub>  
 [279.4mm x 285.8mm]

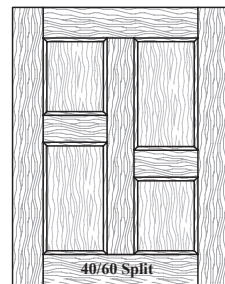

**Style: 3060R**

PC: 232  
 Frame: PC132 x 0.6  
 Min. Size: 11x11<sup>1</sup>/<sub>4</sub>  
 [279.4mm x 285.8mm]

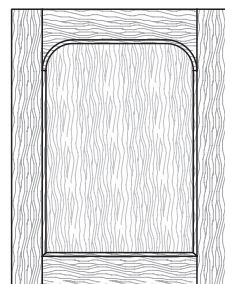

**Style: 2413**

PC: 219  
 Frame: PC119 x 0.6  
 Min. Size: 9x7<sup>3</sup>/<sub>4</sub>  
 [228.6mm x 196.9mm]

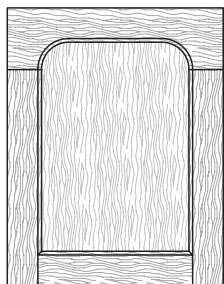

**Style: 2414**

PC: 230  
 Frame: PC130 x 0.6  
 Min. Size: 9x7<sup>3</sup>/<sub>4</sub>  
 [228.6mm x 196.9mm]

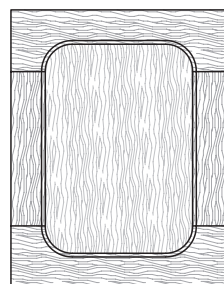

**Style: 2415**

PC: 220  
 Frame: PC120 x 0.6  
 Min. Size: 9x10<sup>1</sup>/<sub>8</sub>  
 [228.6mm x 257.2mm]

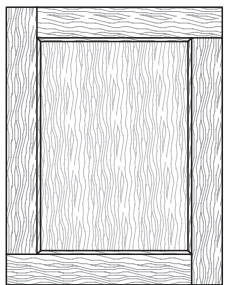

**Style: 2434**

PC: 218  
 Frame: PC118 x 0.6  
 Min. Size: 6x6  
 [152.4mm x 152.4mm]

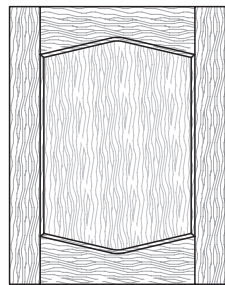

**Style: 2435**

PC: 206  
 Frame: PC106 x 0.6  
 Min. Size: 6<sup>5</sup>/<sub>8</sub>x6  
 [168.3mm x 152.4mm]

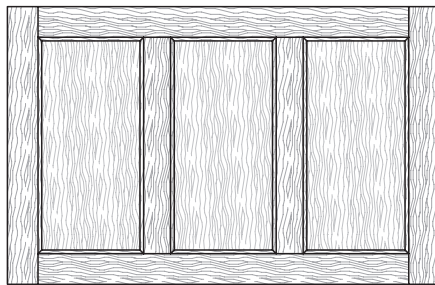

**Style: 4020**

PC: 208  
 Frame: PC108 x 0.6  
 Min. Size: 15<sup>3</sup>/<sub>8</sub>x6<sup>5</sup>/<sub>8</sub>  
 [390.5mm x 168.3mm]

*See Notes for  
 Ordering Information*

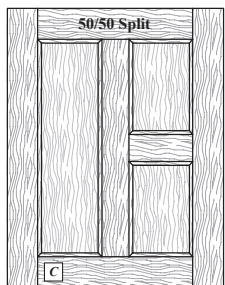

**Style: 3291L**

PC: 231  
 Frame: PC131 x 0.6  
 Min. Size: 11x9<sup>3</sup>/<sub>4</sub>  
 [279.4mm x 247.7mm]

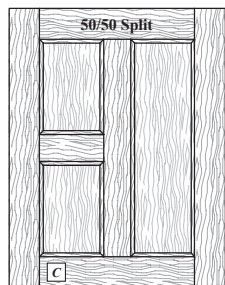

**Style: 3291R**

PC: 231  
 Frame: PC131 x 0.6  
 Min. Size: 11x9<sup>3</sup>/<sub>4</sub>  
 [279.4mm x 247.7mm]

► **For PRICING** ► See Section **B.3** in our current Wholesale Pricing Catalog.

**Traditional Mortise & Tenon - 1/4" Flat Panel**

**Cabinet Door & Drawer Front Options**

**B**

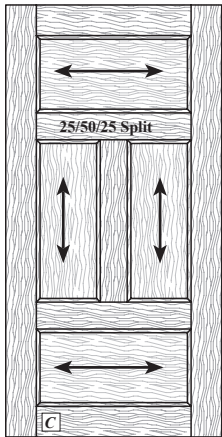

**Style: 4150**

PC: 232  
 Frame: PC132 x 0.6  
 Min. Size: 9"x15"  
 [247.7mm x 381mm]

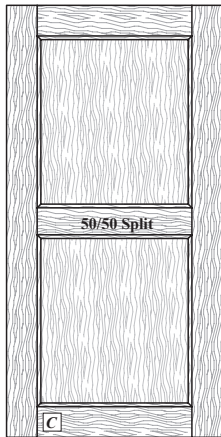

**Style: 4044**

PC: 203  
 Frame: PC103 x 0.6  
 Min. Size: 6"x9 3/4"  
 [168.3mm x 247.7mm]



**Style: 4043**

PC: 203  
 Frame: PC103 x 0.6  
 Min. Size: 6"x11 1/4"  
 [168.3mm x 285.8mm]



**Style: 4041**

PC: 203  
 Frame: PC103 x 0.6  
 Min. Size: 6"x12 3/4"  
 [168.3mm x 323.9mm]

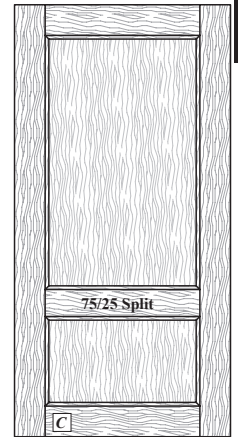

**Style: 4045**

PC: 203  
 Frame: PC103 x 0.6  
 Min. Size: 6"x12 3/4"  
 [168.3mm x 323.9mm]

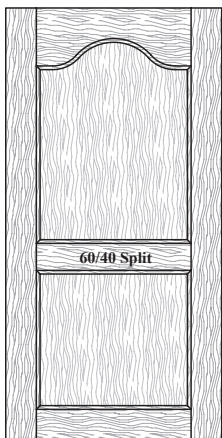

**Style: 2040**

PC: 205  
 Frame: PC105 x 0.6  
 Min. Size: 6"x12 5/32"  
 [168.3mm x 308.8mm]

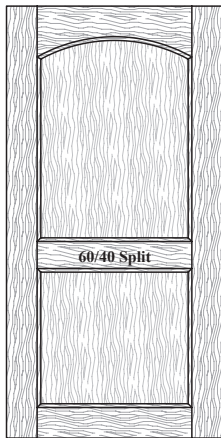

**Style: 3040**

PC: 205  
 Frame: PC105 x 0.6  
 Min. Size: 6"x13"  
 [168.3mm x 330.2mm]

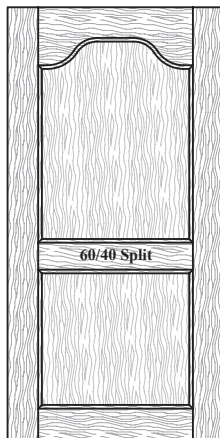

**Style: 2240**

PC: 205  
 Frame: PC105 x 0.6  
 Min. Size: 6"x12 5/32"  
 [168.3mm x 308.8mm]



**Style: 3105**

PC: 205  
 Frame: PC105 x 0.6  
 Min. Size: 6"x10 1/2"  
 [168.3mm x 266.7mm]

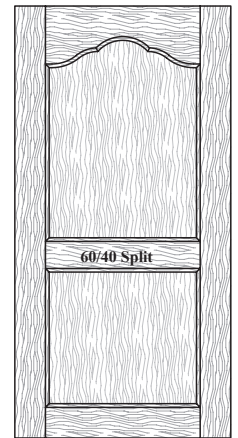

**Style: 3505**

PC: 205  
 Frame: PC105 x 0.6  
 Min. Size: 6"x10 1/2"  
 [168.3mm x 266.7mm]

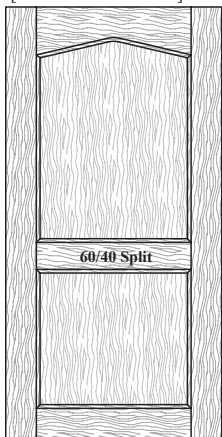

**Style: 3550**

PC: 205  
 Frame: PC105 x 0.6  
 Min. Size: 6"x10 1/2"  
 [168.3mm x 266.7mm]



**Style: 4010**

PC: 214  
 Frame: PC114 x 0.6  
 Min. Size: 9"x12 5/16"  
 [244.5mm x 312.7mm]

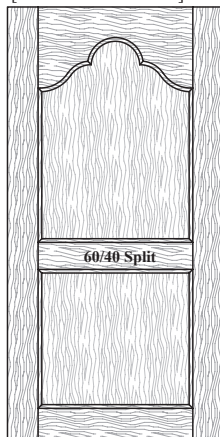

**Style: 7040**

PC: 213  
 Frame: PC113 x 0.6  
 Min. Size: 12"x14 1/4"  
 [304.8mm x 362mm]



**Style: 3333**

PC: 212  
 Frame: PC112 x 0.6  
 Min. Size: 6"x13 3/4"  
 [168.3mm x 336.6mm]

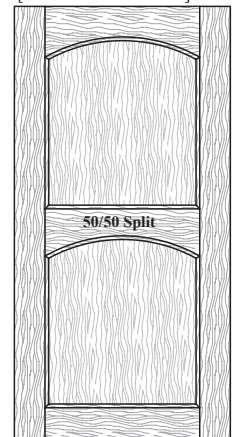

**Style: 3025**

PC: 212  
 Frame: PC112 x 0.6  
 Min. Size: 6"x13"  
 [168.3mm x 330.2mm]

► **For PRICING** ► See Section **B.3** in our current Wholesale Pricing Catalog.

**Cabinet Door & Drawer Front Options**

**Traditional Mortise & Tenon - 1/4" Flat Panel**

**B**

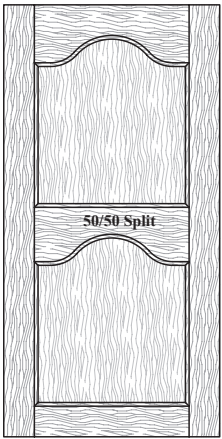

**Style: 3035**

PC: 212  
 Frame: PC112 x 0.6  
 Min. Size: 6 5/8 x 13 1/4  
 [168.3mm x 336.6mm]

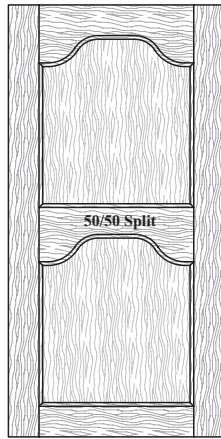

**Style: 3036**

PC: 212  
 Frame: PC112 x 0.6  
 Min. Size: 6 5/8 x 13 1/4  
 [168.3mm x 336.6mm]

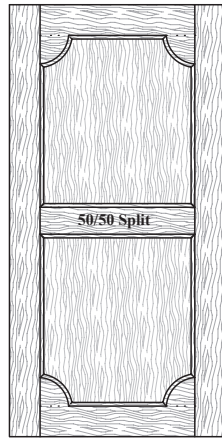

**Style: 2419**

PC: 228  
 Frame: PC128 x 0.6  
 Min. Size: 9 5/8 x 13 3/8  
 [244.5mm x 339.7mm]

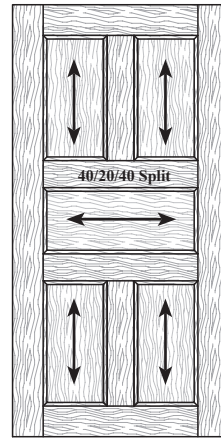

**Style: 3465**

PC: 236  
 Frame: PC136 x 0.6  
 Min. Size: 9 3/4 x 16 1/2  
 [247.7mm x 419.1mm]

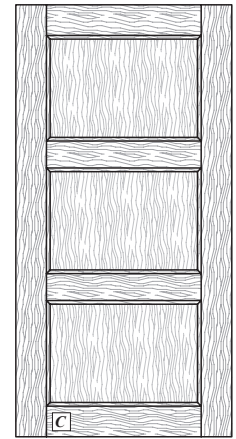

**Style: 4030**

PC: 208  
 Frame: PC108 x 0.6  
 Min. Size: 6 5/8 x 15 5/8  
 [168.3mm x 390.5mm]

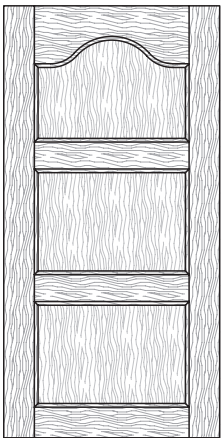

**Style: 3185**

PC: 210  
 Frame: PC110 x 0.6  
 Min. Size: 6 5/8 x 18 3/4  
 [168.3mm x 476.3mm]

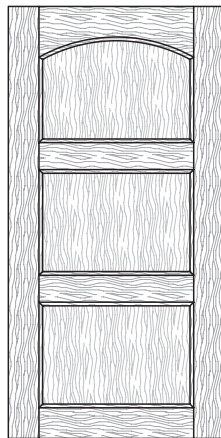

**Style: 3186**

PC: 210  
 Frame: PC110 x 0.6  
 Min. Size: 6 5/8 x 16 1/2  
 [168.3mm x 419.1mm]

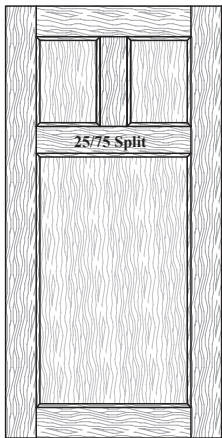

**Style: 2428**

PC: 231  
 Frame: PC131 x 0.6  
 Min. Size: 9 3/4 x 12 3/4  
 [247.7mm x 323.9mm]

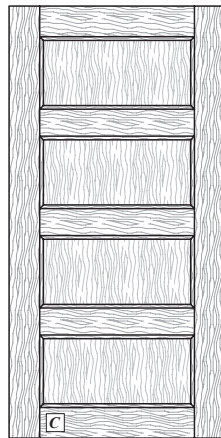

**Style: 3271**

PC: 215  
 Frame: PC115 x 0.6  
 Min. Size: 6 5/8 x 19 3/4  
 [168.3mm x 501.7mm]

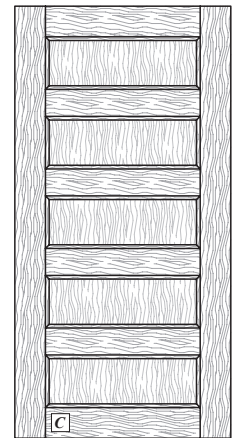

**Style: 3272**

PC: 217  
 Frame: PC117 x 0.6  
 Min. Size: 6 5/8 x 24 5/8  
 [168.3mm x 612.8mm]

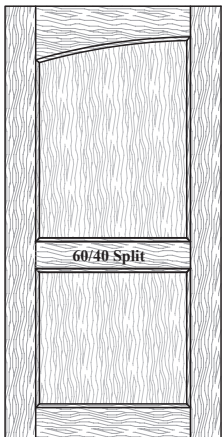

**Style: 2421L**

PC: 205  
 Frame: PC105 x 0.6  
 Min. Size: 6 5/8 x 13  
 [168.3mm x 330.2mm]



**Style: 2421R**

PC: 205  
 Frame: PC105 x 0.6  
 Min. Size: 6 5/8 x 13  
 [168.3mm x 330.2mm]

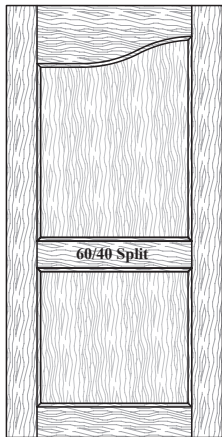

**Style: 2423L**

PC: 205  
 Frame: PC105 x 0.6  
 Min. Size: 6 5/8 x 13  
 [168.3mm x 330.2mm]

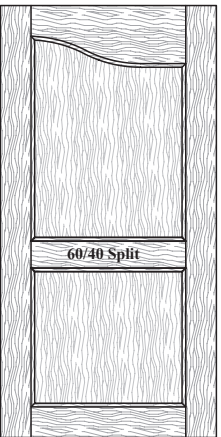

**Style: 2423R**

PC: 205  
 Frame: PC105 x 0.6  
 Min. Size: 6 5/8 x 13  
 [168.3mm x 330.2mm]

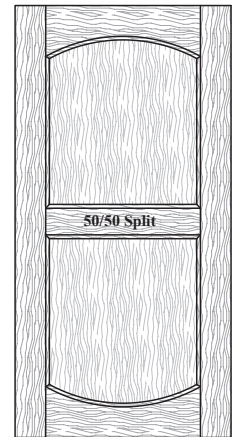

**Style: 2426**

PC: 212  
 Frame: PC112 x 0.6  
 Min. Size: 6 5/8 x 13 1/4  
 [168.3mm x 336.6mm]

► **For PRICING** ► See Section **B.3** in our current Wholesale Pricing Catalog.

**Traditional Mortise & Tenon - 1/4" Flat Panel**

**Cabinet Door & Drawer Front Options**

**B**

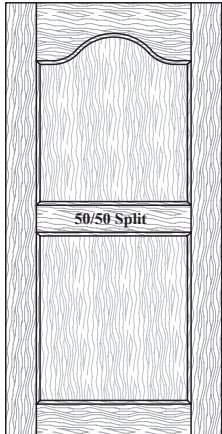

**Style: 2819**

PC: 205  
 Frame: PC105 x 0.6  
 Min. Size: 6 5/8 x 13 1/4  
 [168.3mm x 336.6mm]

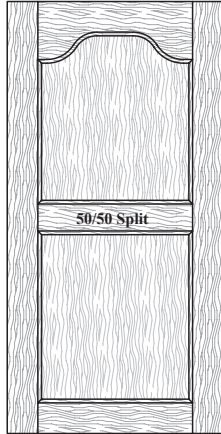

**Style: 2821**

PC: 205  
 Frame: PC105 x 0.6  
 Min. Size: 6 5/8 x 13 1/4  
 [168.3mm x 336.6mm]

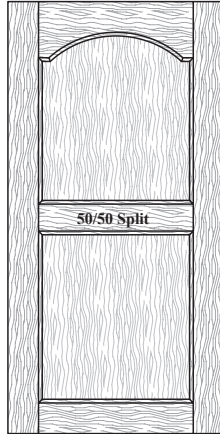

**Style: 2823**

PC: 205  
 Frame: PC105 x 0.6  
 Min. Size: 6 5/8 x 10 3/8  
 [168.3mm x 263.5mm]

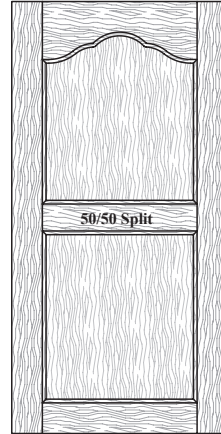

**Style: 2825**

PC: 205  
 Frame: PC105 x 0.6  
 Min. Size: 6 5/8 x 10 5/16  
 [168.3mm x 261.9mm]

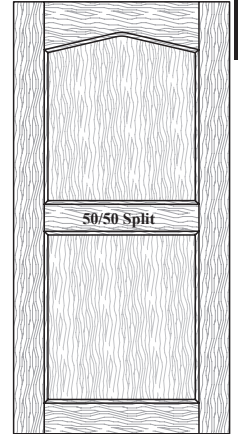

**Style: 2827**

PC: 205  
 Frame: PC105 x 0.6  
 Min. Size: 6 5/8 x 10 3/16  
 [168.3mm x 258.8mm]

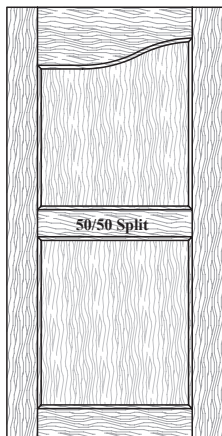

**Style: 2837L**

PC: 205  
 Frame: PC105 x 0.6  
 Min. Size: 6 5/8 x 13  
 [168.3mm x 330.2mm]

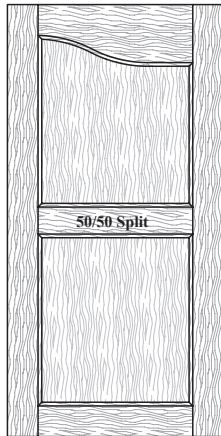

**Style: 2837R**

PC: 205  
 Frame: PC105 x 0.6  
 Min. Size: 6 5/8 x 13  
 [168.3mm x 330.2mm]

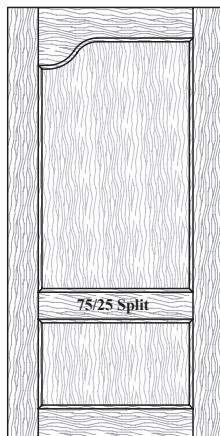

**Style: 2847L**

PC: 205  
 Frame: PC105 x 0.6  
 Min. Size: 6 5/8 x 13  
 [168.3mm x 330.2mm]

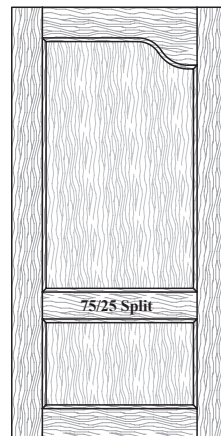

**Style: 2847R**

PC: 205  
 Frame: PC105 x 0.6  
 Min. Size: 6 5/8 x 13  
 [168.3mm x 330.2mm]

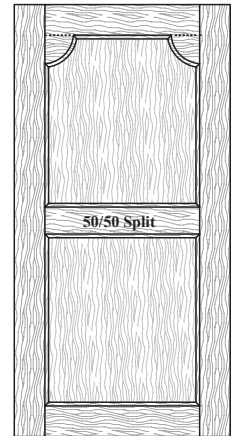

**Style: 2829**

PC: 214  
 Frame: PC114 x 0.6  
 Min. Size: 9 5/8 x 13 3/4  
 [244.5mm x 339.7mm]

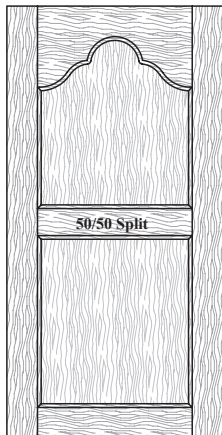

**Style: 2831**

PC: 213  
 Frame: PC113 x 0.6  
 Min. Size: 12 x 17  
 [304.8mm x 431.8mm]

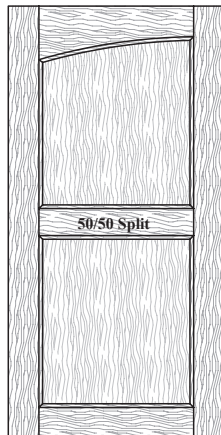

**Style: 2833L**

PC: 205  
 Frame: PC105 x 0.6  
 Min. Size: 6 5/8 x 13  
 [168.3mm x 330.2mm]

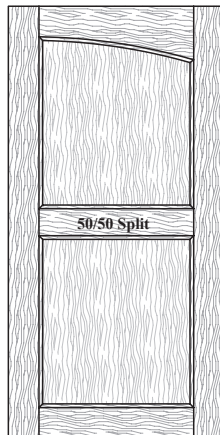

**Style: 2833R**

PC: 205  
 Frame: PC105 x 0.6  
 Min. Size: 6 5/8 x 13  
 [168.3mm x 330.2mm]

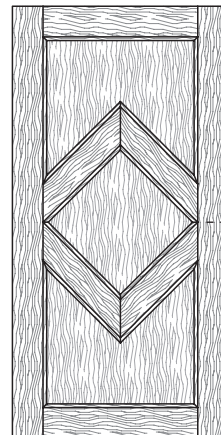

**Style: 2929**

PC: 227  
 Frame: PC127 x 0.6  
 Min. Size: 8 x 18  
 [203.2mm x 457.2mm]

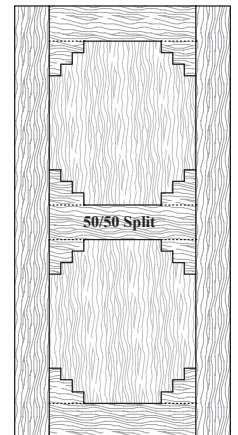

**Style: 3139**

PC: 229  
 Frame: PC129 x 0.6  
 Min. Size: 10 1/2 x 18 3/4  
 [266.7mm x 476.3mm]

C = Center Line of Center Rail

CRP = Center Rail Placement.

B

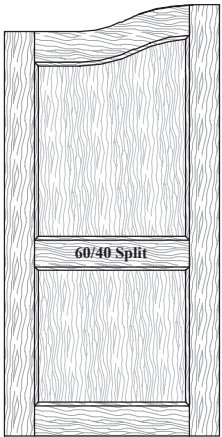

Style: 2499L

PC: 237  
 Frame: PC137 x 0.6  
 Min. Size: 6 5/8 x 11 1/4  
 [168.3mm x 298.5mm]



Style: 2499R

PC: 237  
 Frame: PC137 x 0.6  
 Min. Size: 6 5/8 x 11 1/4  
 [168.3mm x 298.5mm]



Style: 2502L

PC: 237  
 Frame: PC137 x 0.6  
 Min. Size: 6 5/8 x 12 5/8  
 [168.3mm x 320.7mm]

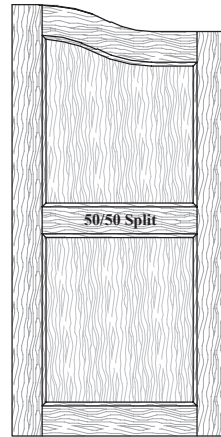

Style: 2502R

PC: 237  
 Frame: PC137 x 0.6  
 Min. Size: 6 5/8 x 12 5/8  
 [168.3mm x 320.7mm]

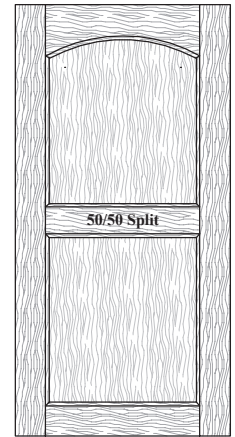

Style: 2526

PC: 205  
 Frame: PC105 x 0.6  
 Min. Size: 6 5/8 x 13  
 [168.3mm x 330.2mm]

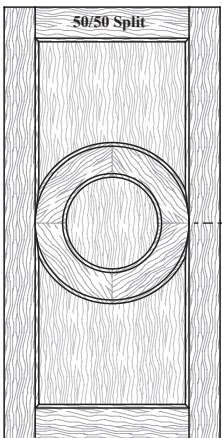

Style: 3156

PC: 227  
 Frame: PC127 x 0.6  
 Min. Size: 11 3/4 x 18  
 [298.5mm x 457.2mm]

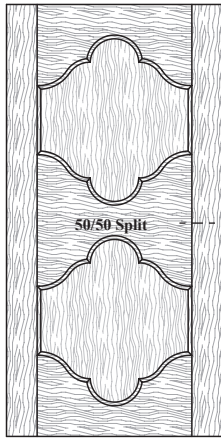

Style: 3456

PC: 235  
 Frame: PC135 x 0.6  
 Min. Size: 12 x 22 3/4  
 [304.8mm x 577.9mm]

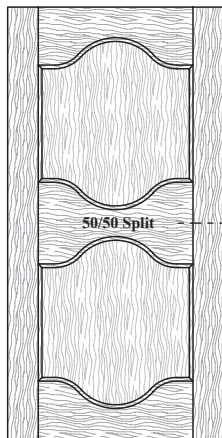

Style: 3434

PC: 216  
 Frame: PC116 x 0.6  
 Min. Size: 6 5/8 x 16 3/4  
 [168.3mm x 425.5mm]

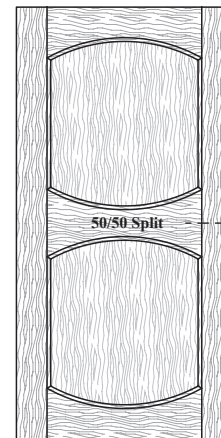

Style: 3171

PC: 216  
 Frame: PC116 x 0.6  
 Min. Size: 6 5/8 x 16 3/4  
 [168.3mm x 425.5mm]

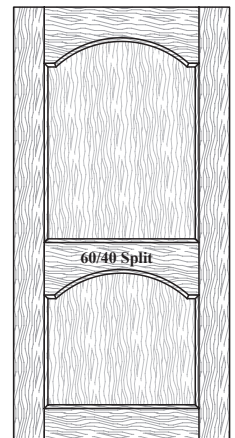

Style: 3288

PC: 212  
 Frame: PC112 x 0.6  
 Min. Size: 6 5/8 x 12  
 [168.3mm x 304.8mm]

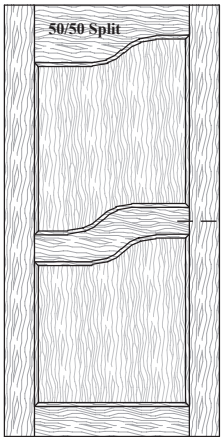

Style: 2562L

PC: 238  
 Frame: PC138 x 0.6  
 Min. Size: 12 x 12  
 [304.8mm x 304.8mm]

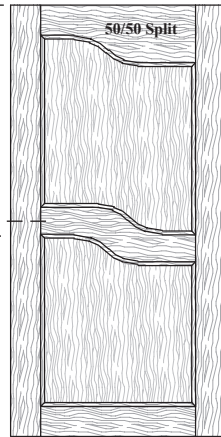

Style: 2562R

PC: 238  
 Frame: PC138 x 0.6  
 Min. Size: 12 x 12  
 [304.8mm x 304.8mm]

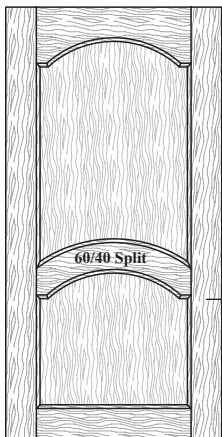

Style: 3287

PC: 238  
 Frame: PC138 x 0.6  
 Min. Size: 6 5/8 x 11 5/8  
 [168.3mm x 295.3mm]

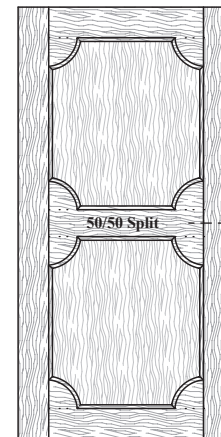

Style: 2417

PC: 229  
 Frame: PC129 x 0.6  
 Min. Size: 9 5/8 x 17  
 [244.5mm x 431.8mm]



Style: 2756

PC: 212  
 Frame: PC112 x 0.6  
 Min. Size: 6 5/8 x 13  
 [168.3mm x 330.2mm]

CL = Center Line of Center Rail

CRP = Center Rail Placement.

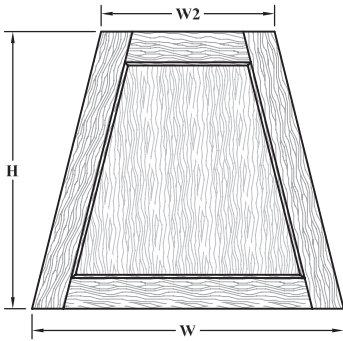

**Style: 3234**

PC: 222  
 Frame: PC122 x 0.6  
 Min. Size: 8x8  
 [203.2mm x 203.2mm]  
 See Notes for  
 Ordering Information

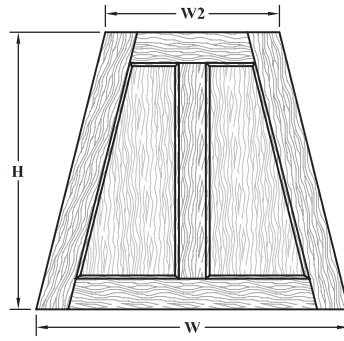

**Style: 3235**

PC: 226  
 Frame: PC126 x 0.6  
 Min. Size: 9 1/4 x 8  
 [247.7mm x 203.2mm]  
 See Notes for  
 Ordering Information

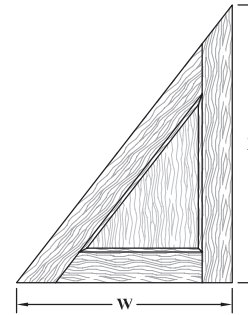

**Style: 3231L**

PC: 222  
 Frame: PC122 x 0.6  
 Min. Size: 8x8  
 [203.2mm x 203.2mm]  
 See Notes for  
 Ordering Information

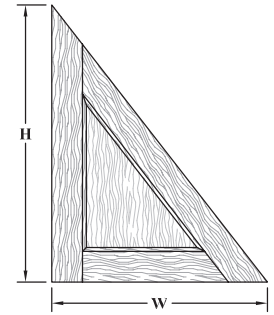

**Style: 3231R**

PC: 222  
 Frame: PC122 x 0.6  
 Min. Size: 8x8  
 [203.2mm x 203.2mm]  
 See Notes for  
 Ordering Information

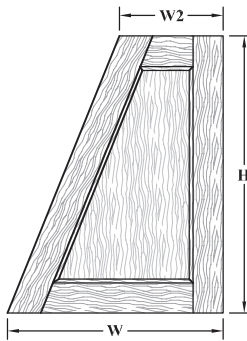

**Style: 3232L**

PC: 222  
 Frame: PC122 x 0.6  
 Min. Size: 8x8  
 [203.2mm x 203.2mm]  
 See Notes for  
 Ordering Information

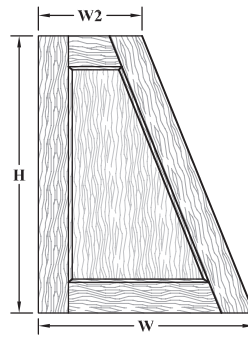

**Style: 3232R**

PC: 222  
 Frame: PC122 x 0.6  
 Min. Size: 8x8  
 [203.2mm x 203.2mm]  
 See Notes for  
 Ordering Information

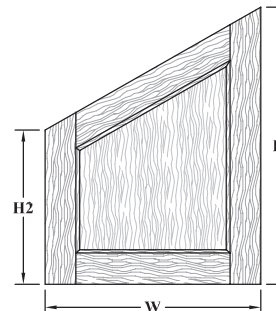

**Style: 3284L**

PC: 222  
 Frame: PC122 x 0.6  
 Min. Size: 8x8  
 [203.2mm x 203.2mm]  
 See Notes for  
 Ordering Information

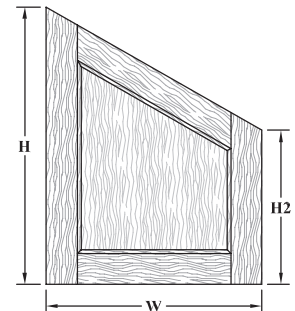

**Style: 3284R**

PC: 222  
 Frame: PC122 x 0.6  
 Min. Size: 8x8  
 [203.2mm x 203.2mm]  
 See Notes for  
 Ordering Information

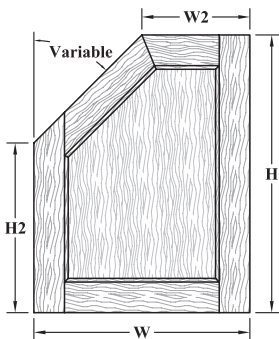

**Style: 2632L**

PC: 239  
 Frame: PC139 x 0.6  
 Min. Size: 9 1/4 x 9 1/4  
 [247.7mm x 247.7mm]  
 See Notes for  
 Ordering Information

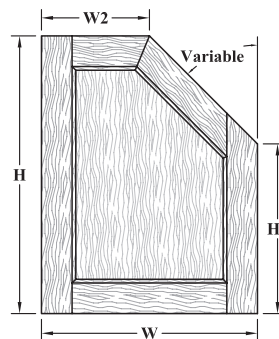

**Style: 2632R**

PC: 239  
 Frame: PC139 x 0.6  
 Min. Size: 9 1/4 x 9 1/4  
 [247.7mm x 247.7mm]  
 See Notes for  
 Ordering Information

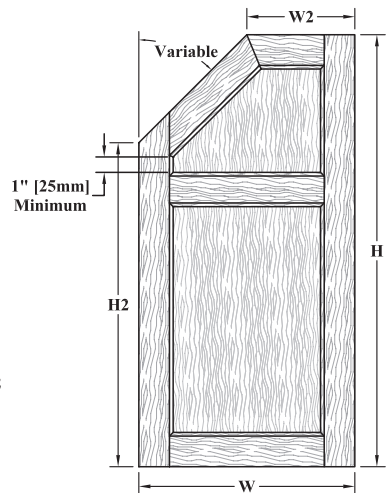

**Style: 3289L**

PC: 240  
 Frame: PC140 x 0.6  
 Min. Size: 9 1/4 x 13 1/4  
 [247.7mm x 349.3mm]  
 See Notes for  
 Ordering Information

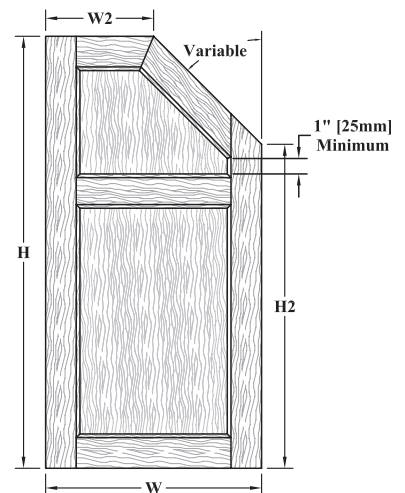

**Style: 3289R**

PC: 240  
 Frame: PC140 x 0.6  
 Min. Size: 9 1/4 x 13 1/4  
 [247.7mm x 349.3mm]  
 See Notes for  
 Ordering Information

► For PRICING ► See Section B.3 in our current Wholesale Pricing Catalog.

## Cabinet Door & Drawer Front Options

## Traditional Mortise & Tenon - 1/4" Flat Panel

B

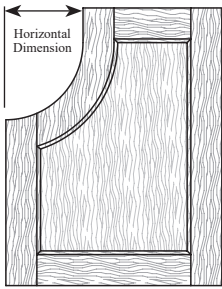

**Style: 3021L**

PC: 225

Frame: PC125 x 0.6

Min. Size: 7x9 3/4

[177.8mm x 247.7mm]

See Notes for Ordering Information

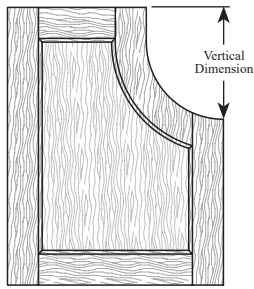

**Style: 3021R**

PC: 225

Frame: PC125 x 0.6

Min. Size: 7x9 3/4

[177.8mm x 247.7mm]

See Notes for Ordering Information

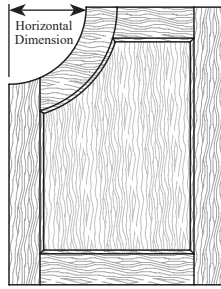

**Style: 3057L**

PC: 225

Frame: PC125 x 0.6

Min. Size: 10 1/2 x 10 1/2

[266.7mm x 266.7mm]

See Notes for Ordering Information

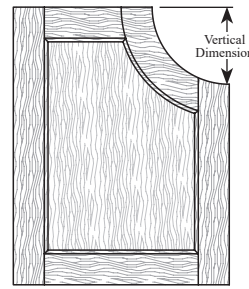

**Style: 3057R**

PC: 225

Frame: PC125 x 0.6

Min. Size: 10 1/2 x 10 1/2

[266.7mm x 266.7mm]

See Notes for Ordering Information

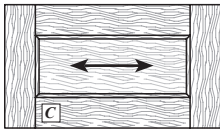

**Style: 40\***  
Drawer Front

PC: 201

Frame: PC101 x 0.6

Min. Size: 6 5/8 x 6

[168.3mm x 152.4mm]

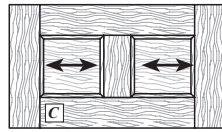

**Style: 4040\***  
Drawer Front

PC: 203

Frame: PC103 x 0.6

Min. Size: 9 3/4 x 6 5/8

[247.7mm x 168.3mm]

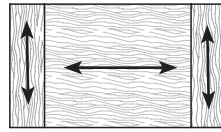

**Style: 1026\***  
Drawer Front

PC: 118

Frame: NA

Min. Size: 6 5/8 x 3

[168.3mm x 76.2mm]

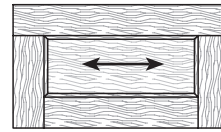

**Style: 1400\***  
Drawer Front

PC: 218

Frame: PC118 x 0.6

Min. Size: 6 5/8 x 6

[168.3mm x 152.4mm]

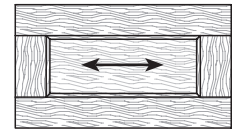

**Style: 1401\***  
Drawer Front

PC: 201

Frame: PC101 x 0.6

Min. Size: 6 x 6 5/8

[152.4mm x 168.3mm]

► For PRICING ► See Section [B.3](#) in our current Wholesale Pricing Catalog.

**B.3.9**  
V19.1



WalzCraft.com



(Phone) 1-800-237-1326

6:00AM - 5:30PM CST

(24 Hour Fax) 1-608-781-3667

Ordering & Pricing Notes: "Traditional" Mortise & Tenon - 1/4" Flat Panel Doors and Drawer Fronts

Ordering Guidelines

1	Order Forms	Please use <i>Door and/or Drawer Front Order Forms (E•Z Forms #2 and #3)</i> .
		When placing an order for a 1/4" Flat Panel door, please indicate the word "Flat" in the space provided for the panel profile on the order form.

Profile Info	
Stile & Rail or Miter Profile	SR107
Panel Profile	Flat
Outside Edge Profile	D17

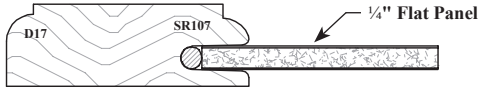

Pricing

1	Pricing	Please see <i>Section B.3</i> of our current Wholesale Pricing Catalog.
---	---------	---

Technical Notes: "Traditional" Mortise & Tenon - 1/4" Flat Panel Doors and Drawer Fronts

Cabinet Door & Drawer Front Options (Chapter B)

1	1/4" Flat Panel Doors and Drawers Fronts	1/4" Flat Panel doors are available with 1/4" veneered or raw MDF center panels.
		To simulate the "look" of a "Flat Panel" door or drawer front, in a solid wood species, <b>please order using a solid wood raised panel door style</b> with the RVSCP-PR324 center panel profile. See <i>Section B.1</i> for Raised Panel Door & Drawer Front Styles and <i>Section E.13</i> for the RVSCP-PR324 center panel profile. For pricing, please see <i>Section B.1</i> of our current Wholesale Pricing Catalog.
2	Frame and Mullion Doors	Glass openings are routed to follow the contour of the shape for Styles 2012L, 2012R, 2072L, 2072R, 2413, 2414, 2415, 2417, 2419, 2499L, 2499R, 2502L, 2502R, 2562L, 2562R, 2632L, 2632R, 2829, 2929, 3021L, 3021R, 3057L, 3057R, 3100L, 3100R, 3131L, 3131R, 3156, 3187, 3231L, 3231R, 3232L, 3232R, 3234, 3235, 3284L, 3284R, 3287 (Center rail only), 3289L, 3289R, 4010, 4060, 4070, 4080, 4090. For pricing, please see <i>Section B.12</i> of our current Wholesale Pricing Catalog.
3	Style 1026*	Only available as a drawer front.
		Only available in solid wood and raw MDF (not available in a hybrid species).
		Maximum height is 12" [304.8mm]. Heights up to 6" [152.4mm] will be constructed without glue-ups whenever possible.
4	Style 2413, 2414, 2415	The width of the stiles and rails is fixed at 2 1/4" [57.2mm] (at the narrowest point).
		Radius is fixed at 1 3/4" [44.5mm].
		Please submit requests for all other dimensions to our Customer Support Team. <ul style="list-style-type: none"> <li>• Additional charges will apply.</li> </ul>
5	Style 2632L, 2632R	Please provide overall width (W) and height (H), as well as the secondary width (W2) at the top of door and the secondary height (H2) at the side of the door.
		Angle will vary as dimensions vary. <b>A CAD drawing must be approved prior to manufacturing the product.</b>
6	Style 2929	Overall width of door and stile & rail width will determine size of interior diamond.
		Sides of interior diamond will remain equal in length to one another.
		Angles are fixed at 45°. <b>A CAD drawing must be approved prior to manufacturing the product.</b>
7	Style 3021L & 3021R	Minimum radius = 2" [50.8mm]. The radius will equal 90 degrees of an arc on the outside edge.
		The horizontal dimension of the curved stile (as shown in the illustration) equals the radius. <i>These door style illustrations depict a 14" x 18" [355.6mm x 457.2mm] door with a curved stile radius of 5" [127mm].</i>
		The vertical dimension of the curved stile (as shown in the illustration) equals the radius plus the width of the top rail. <i>Based on the 14" x 18" [355.6mm x 457.2mm] door size illustrated along with the 5" [127mm] radius, this dimension would be 7 1/4" [184.2mm].</i>
		When ordering, please provide the overall width and height of the door and note the horizontal dimension (radius) in the <b>Special Instructions</b> column on the order form. <b>A CAD drawing must be approved prior to manufacturing the product.</b>

Continued on next page...

► For PRICING ► See Section B.3 in our current Wholesale Pricing Catalog.

**Technical Notes: "Traditional" Mortise & Tenon - ¼" Flat Panel Doors and Drawer Fronts ...continued**

**Cabinet Door & Drawer Front Options (Chapter B)...continued**

8	Style 3057L & 3057R	Minimum radius = 2" [50.8mm]. The radius will equal 90 degrees of an arc on the outside edge.
		The horizontal dimension of the curved rail (as shown in the illustration) equals the radius. <i>These door style illustrations depict a 14" x 18" [355.6mm x 457.2mm] door with a curved stile radius of 5" [127mm].</i>
		The vertical dimension of the curved rail (as shown in the illustration) equals the radius. <i>These door style illustrations depict a 14" x 18" [355.6mm x 457.2mm] door with a curved stile radius of 5" [127mm].</i>
		When ordering, please provide us with the overall width and height of the door and note the horizontal dimension (radius) in the <b>Special Instructions</b> column on the order form. <b>A CAD drawing must be approved prior to manufacturing the product.</b>
9	Style 3156	Width cannot be greater than the height. • Minimum visual opening width for center circle is 7¼" [184.2mm].
		Minimum height must be 2 times the width minus 4" [101.6mm].
		Available with all "Traditional" and Old World "Traditional" Stile and Rail profiles.
		When ordered in a rustic grade, the center rail/circle will not have large knots. It may contain small knots or possibly, no knots at all. WalzCraft will try to maintain a rustic grade look utilizing other characteristics. See <b>Section S.1</b> for more information on rustic grades. <b>A CAD drawing must be approved prior to manufacturing the product.</b>
10	Style 3231L, 3231R	Please provide overall width (W) and height (H).
		Angles will vary as dimensions vary.
		<b>A CAD drawing must be approved prior to manufacturing the product.</b>
11	Style 3232L, 3232R, & 3234	Please provide overall width (W) and height (H), as well as the secondary width (W2) at the top of door.
		Angles will vary as dimensions vary.
		<b>A CAD drawing must be approved prior to manufacturing the product.</b>
12	Style 3235	Please provide overall width (W) and height (H), as well as the secondary width (W2) at the top of door.
		Angles will vary as dimensions vary.
		Center stile will be centered on width (50/50 split), unless otherwise noted.
		<b>A CAD drawing must be approved prior to manufacturing the product.</b>
13	Style 3284L, 3284R	Please provide overall width (W) and height (H), as well as the secondary height (H2) along the side of door.
		Angles will vary as dimensions vary.
		<b>A CAD drawing must be approved prior to manufacturing the product.</b>
14	Style 3289L, 3289R	Please provide overall width (W) and height (H), as well as the secondary width (W2) at the top of door and the secondary height (H2) at the side of the door.
		Angle will vary as dimensions vary.
		Center rail is shown at its highest point, which is also its standard placement, unless otherwise noted.
		<b>A CAD drawing must be approved prior to manufacturing the product.</b>
15	Style 3139, 4050 & 4055	If ordered below 10½ [266.7mm] wide, the corner blocks will be reduced to accommodate the width, based on 2¼" [57.2mm] stiles & rails.
		Can <i>only</i> be ordered with the <b>SR100</b> stile and rail profile.
		Not available with the <b>RVSCP-PR324</b> reverse solid center panel profile.

**Convex/Concave Options (Chapter D)**

1	Available Products	The ☐ indicates door styles that are available Convex/Concave (curved). See <b>Chapter D</b> for more information.
2	Raw MDF	Traditional mortise & tenon doors and drawer fronts made from <b>MDF</b> or <b>MDF-MR</b> are not available convex/concave.

Continued on next page...

► For PRICING ► See Section **B.3** in our current Wholesale Pricing Catalog.

Technical Notes: "Traditional" Mortise & Tenon - 1/4" Flat Panel Doors and Drawer Fronts ...continued

Finish Options (Chapter R)

1	Raw MDF	See Finishing Methods ( <i>Section R.2</i> ) for information on <b>MDF</b> or <b>MDF-MR</b> with Primed Only for Paint or SolidTone® Colors. Traditional mortise & tenon doors and drawer fronts made from <b>MDF</b> or <b>MDF-MR</b> are not available with 3D Laminate.
---	---------	---

Functional Options (Chapter F)

1	Hinge Boring	Hinge boring is available for all "Traditional" Mortise & Tenon - 1/4" Flat Panel doors and drawer fronts. Please see <i>Section F.1</i> for additional hinge boring requirements, ordering instructions and compatibility.
---	--------------	---

General Information (Chapter A)

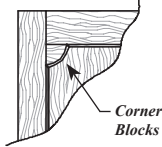
1	Grain Direction	Arrows (←→) shown throughout the catalog indicate standard grain direction. Grain direction may be specified at <b>NO</b> additional cost.  <i>Corner blocks</i> on all applicable door styles (ex: <b>Style 4080</b> ) will have a standard <i>horizontal</i> grain direction.
		
2	Ready to Assemble (RTA)	RTA is available as an option.
3	Center Rail Placement	Custom center rail placement may be specified and refers to the distance from the top of the top rail to the top of the center rail for most door styles ( <i>see below for exceptions</i> ). <b>Styles 2417, 2929, 3156, 3171, 3434, 3456:</b> For custom rail placement, measure from the top of the door to the center of the center rail. <b>Styles 2562L, 2562R:</b> For custom rail placement, measure from the top of the door to the center of the center rail at its highest point. <b>Style 3287:</b> For custom rail placement, measure from the top of the door to the bottom of the center rail at its lowest point. See <b>Center Rail Placement</b> in <i>Section A.4</i> for more information.
4	Stile & Rail Dimensions	Standard stile and rail dimensions are 2 1/4" [57.2mm] wide. Non-standard part sizes may be ordered, however, additional up-charges may apply. See <i>Section A.5</i> for more information.

Material Options

1	Core Material	Veneered flat panel doors are constructed using a 1/4" [6.4mm] "A" face grade veneer with an <b>MDF</b> core.
2	Materials Available	Available in all of the species/grades noted in <i>Section B.3</i> of our current <b>Wholesale Pricing Catalog</b> . • See individual door style notes for exceptions.
3	Door Style 3156 Hybrid/MDF	When ordering door style <b>3156</b> in <b>Hybrid/MDF</b> (solid wood stiles & rails with raw <b>MDF</b> center panel), the center rail / circle will be made from raw <b>MDF</b> for SolidTone® or Primed Only for Paint applications.

Molding Options (Chapter N)

1	Applied Moldings on MDF	When an applied molding is added to an <b>MDF</b> product, the molding will be made from Maple-Hard/Soft Mixed-Value / Budget/Paint Grade.
---	-------------------------	--

Continued on next page...

► For PRICING ► See *Section B.3* in our current Wholesale Pricing Catalog.

Technical Notes: "Traditional" Mortise & Tenon - 1/4" Flat Panel Doors and Drawer Fronts ...continued

Profile Options (Chapter E)

1	Door Styles 31, 2435, 2827	When adding an applied molding to the stiles and rails of these door styles, the molding for the arched rails will be made from two pieces, so as to have a miter joint at the peak of the arch.
---	----------------------------	--

Sizes/Dimensions

1	Minimum W x H	Use the dimensions noted below the image of your chosen door style on the preceding pages.
2	Thicknesses	<p>When using Traditional stile and rail profiles, Traditional Mortise &amp; Tenon 1/4" flat panel doors and DFs made from solid wood are available 3/4" [19.3mm] and 1" [25.4mm] thick.</p> <p>When using Old World stile and rail profiles, Traditional Mortise &amp; Tenon 1/4" flat panel doors and DFs made from solid wood are available 1" [25.4mm], 1 1/8" [28.6mm] and 1 1/4" [31.8mm] thick.</p> <p>See <b>Section S.3</b> for possible thickness restrictions based on wood species.</p> <p>Traditional mortise &amp; tenon raised panel doors and DFs made from raw <b>MDF</b> are available 3/4" [19.1mm] and 1" [25.4mm] thick.</p> <p>Traditional mortise &amp; tenon raised panel doors and DFs made from raw <b>MDF-MR</b> are only available 3/4" [19.1mm] thick.</p> <p>Old World mortise &amp; tenon raised panel doors and DFs made from raw <b>MDF</b> are only available 1" [25.4mm] thick.</p>
3	MDF Maximum Size	The maximum size for a Traditional mortise & tenon door made from raw <b>MDF</b> or <b>MDF-MR</b> will be 48" x 96" [1219.2mm x 2438.4mm] or 96" x 48" [2438.4mm x 1219.2mm].
4	Maximum Center Panel Size Limitation	Given the 1/4" [6.4mm] veneered flat panel material used for center panels is 48"W x 96"H [1219.2mm x 2438.4mm], the maximum visible center panel width in a door with vertical grain and no center stile is 47 1/8" [1197mm]; the maximum visible center panel height with no center rail is 95 1/8" [2416.2mm].
5	Maximum Width for Doors with Shaped Rails	<p>The maximum width for a WalzCraft standard door with a shaped rail or rails is 30" [762.0mm] - (based on 2 1/4" [57.2mm] wide stiles).</p> <ul style="list-style-type: none"> <li>• Please submit requests for doors with shaped rails over 30" wide to our Customer Support Team, as additional charges may apply.</li> <li>• This does not include doors made with corner blocks (Price Classes 207, 211, 214, 221, 224, 228, 229).</li> </ul>

Traditional Mortise & Tenon 1/4" Flat Panel Doors and Drawer Fronts - END

► For PRICING ► See Section B.3 in our current Wholesale Pricing Catalog.

Quarter Circle Doors - 1/4" Flat Panel

B

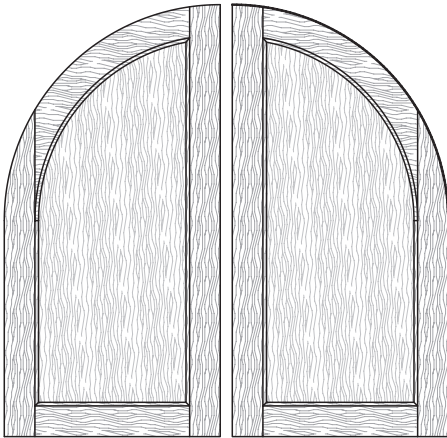

Style: 895L

PC: 952  
 Frame: PC906 x 0.6  
 Min. Size: 8x10 1/4  
 [203.2mm x 260.4mm]  
 Outside Radius

Style: 895R

PC: 952  
 Frame: PC906 x 0.6  
 Min. Size: 8x10 1/4  
 [203.2mm x 260.4mm]  
 Outside Radius

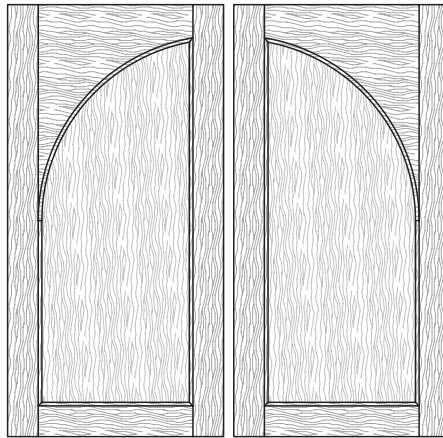

Style: 896L

PC: 951  
 Frame: PC905 x 0.6  
 Min. Size: 8x10 1/4  
 [203.2mm x 260.4mm]  
 Outside Radius

Style: 896R

PC: 951  
 Frame: PC905 x 0.6  
 Min. Size: 8x10 1/4  
 [203.2mm x 260.4mm]  
 Outside Radius

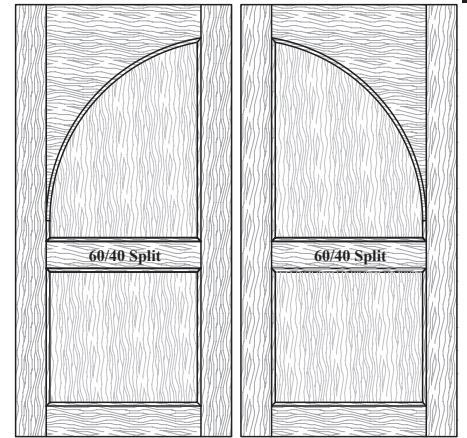

Style: 2432L

PC: 953  
 Frame: PC907 x 0.6  
 Min. Size: 8x16 1/4  
 [203.2mm x 412.8mm]  
 Outside Radius

Style: 2432R

PC: 953  
 Frame: PC907 x 0.6  
 Min. Size: 8x16 1/4  
 [230.2mm x 412.8mm]  
 Outside Radius

**Quarter Circle Radius Explanation**  
 The difference between Outside & Inside Radius

All **Outside Radius** doors feature a radius that is measured from the **outside edge** of the door stile.

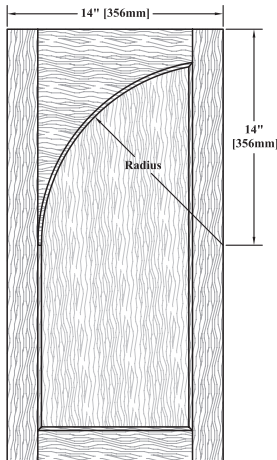

To Calculate Radius Center Point:

**From door width,**  
 Measure down from the top of the door and mark the radius center point on the outside edge of the stile.

All **Inside Radius** doors feature a radius that is measured from the **inside edge** of the door stile.

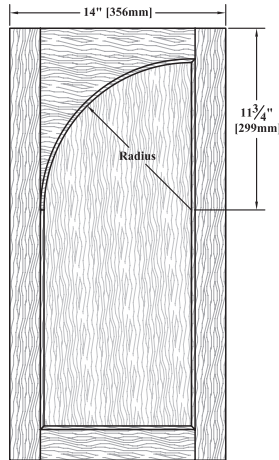

To Calculate Radius Center Point:

**Door width minus the Stile Width: 2 1/4" [57.2mm],**  
 Measure down from the top of the door and mark the radius center point on the inside edge of the stile.

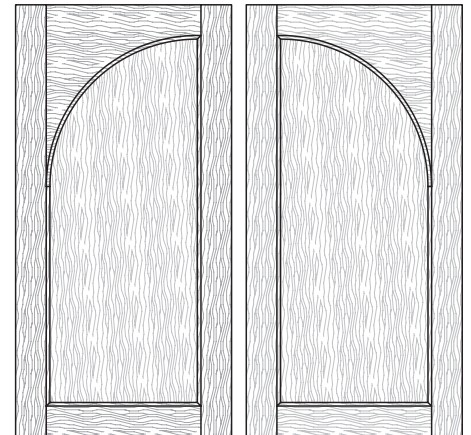

Style: 897L

PC: 951  
 Frame: PC905 x 0.6  
 Min. Size: 8x8  
 [203.2mm x 203.2mm]  
 Inside Radius

Style: 897R

PC: 951  
 Frame: PC905 x 0.6  
 Min. Size: 8x8  
 [203.2mm x 203.2mm]  
 Inside Radius

► For PRICING ► See Section B.4 in our current Wholesale Pricing Catalog.

Half Circle Doors - 1/4" Flat Panel

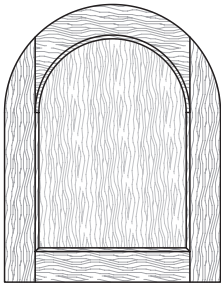

Style: 1890

PC: 952  
 Frame: PC906 x 0.6  
 Min. Size: 9x6 1/4  
 [228.6mm x 171.5mm]

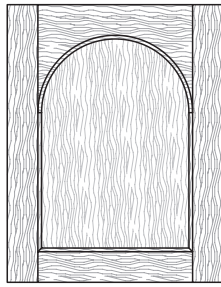

Style: 1896

PC: 951  
 Frame: PC905 x 0.6  
 Min. Size: 9x6 1/4  
 [228.6mm x 171.5mm]

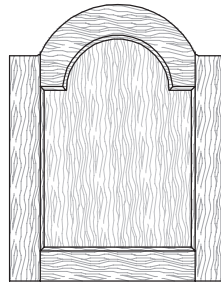

Style: 3020

PC: 952  
 Frame: PC906 x 0.6  
 Min. Size: 12x12  
 [304.8mm x 304.8mm]

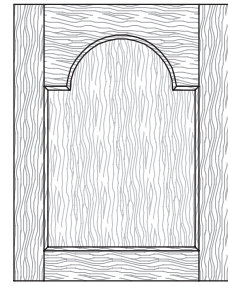

Style: 3022

PC: 951  
 Frame: PC905 x 0.6  
 Min. Size: 12x12  
 [304.8mm x 304.8mm]

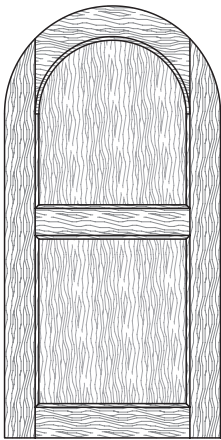

Style: 2961

PC: 955  
 Frame: PC909 x 0.6  
 Min. Size: 9x13  
 [228.6mm x 330.2mm]

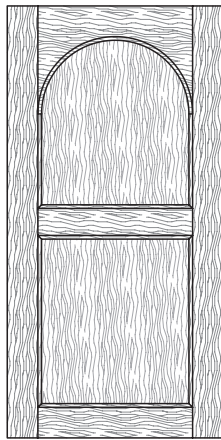

Style: 2963

PC: 954  
 Frame: PC908 x 0.6  
 Min. Size: 9x13  
 [228.6mm x 330.2mm]

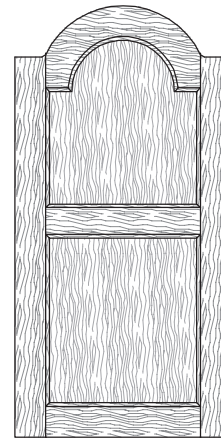

Style: 2965

PC: 955  
 Frame: PC909 x 0.6  
 Min. Size: 12x17  
 [304.8mm x 431.8mm]

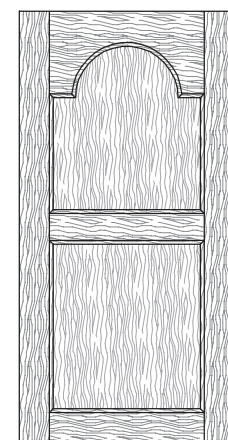

Style: 2967

PC: 954  
 Frame: PC908 x 0.6  
 Min. Size: 12x17  
 [304.8mm x 431.8mm]

Ordering & Pricing Notes: Quarter Circle & Half Circle Doors - 1/4" Flat Panel

Ordering Guidelines

1 Order Forms

Please use *Door Order Form (E-Z Form #2)*.

When placing an order for a 1/4" Flat Panel door, please indicate the word "Flat" in the space provided for the panel profile on the order form.

Profile Info

Stile & Rail or Miter Profile	SR107
Panel Profile	Flat
Outside Edge Profile	D17



Pricing

1 Pricing

Please see *Section B.4* of our current Wholesale Pricing Catalog.

Continued on next page...

► For PRICING ► See Section B.4 in our current Wholesale Pricing Catalog.

**Technical Notes: Quarter Circle & Half Circle Doors - 1/4" Flat Panel**

**Cabinet Door & Drawer Front Options (Chapter B)**

1	Frame & Mullion Doors	Glass openings are routed to follow the contour of the shape for Styles <b>895L, 895R, 896L, 896R, 897L, 897R, 1890, 1896, 2432L, 2432R, 2961, 2963, 2965, 2967, 3020, 3022</b> . For pricing, please see <b>Section B.12</b> of our current <b>Wholesale Pricing Catalog</b> .
2	Radius Explanation	See beginning of this section ( <b>B.4</b> ) for an explanation of <b>Inside</b> and <b>Outside</b> radius door measurements.
3	Styles 3022, 2967	Available with all "Traditional" and Old World "Traditional" Stile and Rail profiles.
		Available with all Outside Edge Profiles. <b>A CAD drawing must be approved prior to manufacturing the product.</b>
4	Style 3020, 2965	Available with all "Traditional" and Old World "Traditional" Stile and Rail profiles.
		Only available with the following Outside Edge Profiles: <b>D7, D12, D15, D17, D18, D21, D24, D32, D41, D52, D67, D93, D101, D102, D115, D118, D120</b> .
		<b>A CAD drawing must be approved prior to manufacturing the product.</b>
5	Center Rail Placement	Center rail placement must be specified and refers to the distance from the top of the top rail to the top of the center rail for most door styles. See Center Rail Placement in <b>Section A.4</b> for more information.

**Functional Options (Chapter F)**

1	Hinge Boring	Hinge boring is available for all Quarter & Half Circle - 1/4" Flat Panel doors. Please see <b>Section F.1</b> for additional hinge boring requirements, ordering instructions and compatibility.
---	--------------	---

**General Information (Chapter A)**

1	Ready to Assemble (RTA)	RTA is <i>not</i> available as an option.
---	-------------------------	---

**Material Options**

1	Core Material	Veneered flat panel doors are constructed using a 1/4" [6.4mm] "A" face grade veneer with an <b>MDF</b> core.
---	---------------	---

**Profile Options (Chapter E)**

1	Stile & Rail Profile Options	Compatible with all "Traditional" and "Old World" stile and rail profiles (excluding Mirror Joints).
2	1/4" Flat Panel Doors and Drawers Fronts	To simulate the "look" of a "Flat Panel" door or drawer front, in a solid wood species, <b>please order using a solid wood raised panel door style</b> with the <b>RVSCP-PR324</b> center panel profile. See <b>Section B.2</b> for Raised Panel Door & Drawer Front Styles and <b>Section E.13</b> for the <b>RVSCP-PR324</b> center panel profile. For pricing, please see <b>Section B.2</b> of our current <b>Wholesale Pricing Catalog</b> .

**Sizes/Dimensions**

1	Door Widths	Styles <b>895L/R, 896L/R, 897L/R, 1890, 1896, 2432L/R, 2961</b> and <b>2963</b> widths can only be ordered in 1/4" [6.4mm] increments.
		Styles <b>3020, 3022, 2965</b> and <b>2967</b> are available from 12" [304.8mm] to 24" [609.6mm] wide in 1" [25.4mm] increments only.
2	Outside Radius	Style <b>895L, 895R, 896L, 896R</b> : The height must be at least 2 1/4" [57.2mm] greater than the width.
		Style <b>2432L, 2432R</b> : The height must be at least two times the width of the door.
3	Inside Radius	Height must be equal to or greater than the width.
4	Half Circle Doors	Width must be less than or equal to the door height, less the width of the (bottom rail x 2).
		Height must be greater than or equal to 1/2 of the door width, plus the width of the bottom rail and center rail (if applicable).
5	Stile & Rail Sizes	<ul style="list-style-type: none"> <li>Traditional Quarter and Half Circle doors will have stile/rail width fixed at 2 1/4" [57.2mm] wide.</li> <li>Old World Quarter and Half Circle doors will have stile/rail width fixed at 3" [76.2mm] wide.</li> <li>Please submit requests for other widths to our Customer Support Team as additional charges may apply.</li> </ul>
6	Thicknesses	When using Traditional stile and rail profiles, Quarter Circle and Half Circle 1/4" flat panel doors made from solid wood are available 3/4" [19.3mm] and 1" [25.4mm] thick.
		When using Old World stile and rail profiles, Quarter Circle and Half Circle 1/4" flat panel doors made from solid wood are available 1" [25.4mm], 1 1/8" [28.6mm] and 1 1/4" [31.8mm] thick.
		See <b>Section S.3</b> for possible thickness restrictions based on wood species.

**Quarter & Half Circle 1/4" Flat Panel Doors - END**

► For PRICING ► See Section B.4 in our current Wholesale Pricing Catalog.

Gothic Doors - 1/4" Flat Panel

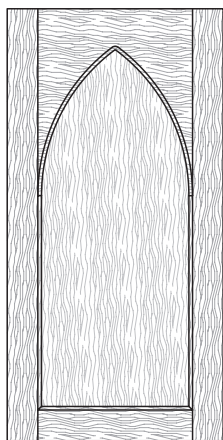

**Style: 4100**  
 PC: 951  
 Frame: PC905 x 0.6  
 Min. Size: 10x11  
 [254mm x 279.4mm]

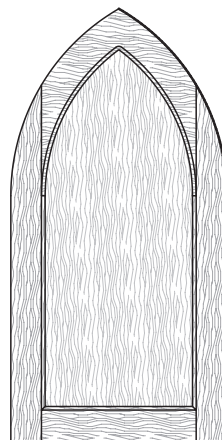

**Style: 4200**  
 PC: 952  
 Frame: PC906 x 0.6  
 Min. Size: 10x11  
 [254mm x 279.4mm]

Ordering & Pricing Notes: Gothic Doors - 1/4" Flat Panel

Ordering Guidelines

1	Order Forms	Please use <i>Door Order Form (E•Z Form #2)</i> .
<b>Pricing</b>		
1	Pricing	Please see <i>Section B.4</i> of our current Wholesale Pricing Catalog.

Technical Notes: Gothic Doors - 1/4" Flat Panel

Cabinet Door & Drawer Front Options (Chapter B)

1	Frame & Mullion Doors	Glass openings will be routed to follow the contour of the shape for Styles <b>4100</b> and <b>4200</b> . For pricing, please see <i>Section B.12</i> of our current Wholesale Pricing Catalog.
---	-----------------------	---

Functional Options (Chapter F)

1	Hinge Boring	Hinge boring is available for all Gothic - 1/4" Flat Panel doors. Please see <i>Section F.1</i> for additional hinge boring requirements, ordering instructions and compatibility.
---	--------------	--

Profile Options (Chapter E)

1	Stile & Rail Profile Options	Compatible with all "Traditional" and "Old World" stile and rail profiles (excluding Mirror Joints). Mitered stile and rail profiles are <i>not</i> an option for Gothic doors.
2	1/4" Flat Panel Doors and Drawers Fronts	To simulate the "look" of a "Flat Panel" door or drawer front, in a solid wood species, <b>please order using a solid wood raised panel door style</b> with the RVSCP-PR324 center panel profile. See <i>Section B1</i> for Raised Panel Door & Drawer Front Styles and <i>Section E.13</i> for the RVSCP-PR324 center panel profile. For pricing, please see <i>Section B.1</i> of our current Wholesale Pricing Catalog.

Sizes/Dimensions

1	Minimum Height	Minimum height equals door width plus 1" [25.4mm].
2	Absolute Minimum Width	The absolute minimum width for a flat panel Gothic door is 10" [254mm].
3	Top Rail Width	In order to maintain the "look" and shape of the Gothic arch, the width of the top rail at the peak of the arch will vary slightly from the width of the remaining stiles and rail. This dimension will also fluctuate based on the overall width of the door. If needing to specify this dimension, please submit your request to our Customer Support Team.
4	Thicknesses	When using Traditional stile and rail profiles, Gothic 1/4" flat panel doors made from solid wood are available 3/4" [19.3mm] and 1" [25.4mm] thick.
		When using Old World stile and rail profiles, Gothic 1/4" flat panel doors made from solid wood are available 1" [25.4mm], 1 1/8" [28.6mm] and 1 1/4" [31.8mm] thick. See <i>Section S.3</i> for possible thickness restrictions based on wood species.

Gothic 1/4" Flat Panel Doors - END

► For PRICING ► See *Section B.4* in our current Wholesale Pricing Catalog.





B

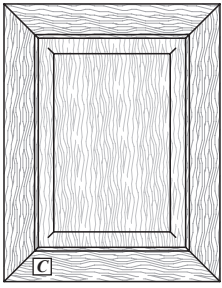

**Style: 10M**

PC: 301  
 Frame: PC301 x 0.6  
 Min. Size: 8x8  
 [203.2mm x 203.2mm]

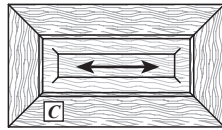

**Style: 10M\***  
 Drawer Front

PC: 301  
 Frame: PC301 x 0.6  
 Min. Size: 8x8  
 [203.2mm x 203.2mm]  
*Shown with 2 1/4" [57.2mm] stiles & rails*

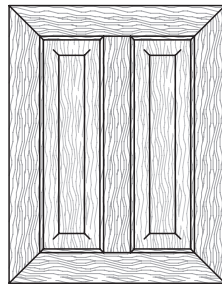

**Style: 1010M**

PC: 303  
 Frame: PC303 x 0.6  
 Min. Size: 13 3/4 x 8  
 [349.3mm x 203.2mm]

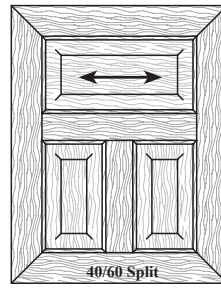

**Style: 8010M**

PC: 331  
 Frame: PC331 x 0.6  
 Min. Size: 13 3/4 x 15  
 [349.3mm x 381mm]

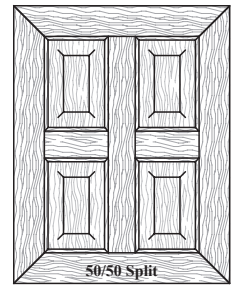

**Style: 8160M**

PC: 315  
 Frame: PC315 x 0.6  
 Min. Size: 13 3/4 x 13 3/4  
 [349.3mm x 349.3mm]



**Style: 8000M**

PC: 303  
 Frame: PC303 x 0.6  
 Min. Size: 8x13 3/4  
 [203.2mm x 349.3mm]



**Style: 1000M**

PC: 303  
 Frame: PC303 x 0.6  
 Min. Size: 8x15 1/2  
 [203.2mm x 393.7mm]



**Style: 1941M**

PC: 303  
 Frame: PC303 x 0.6  
 Min. Size: 8x16 3/4  
 [203.2mm x 415.9mm]



**Style: 8045M**

PC: 303  
 Frame: PC303 x 0.6  
 Min. Size: 8x16 3/4  
 [203.2mm x 415.9mm]

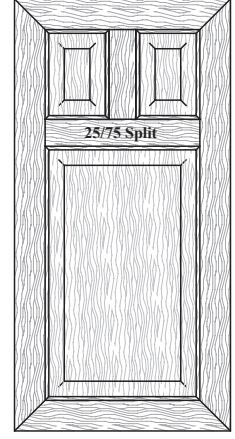

**Style: 2427M**

PC: 331  
 Frame: PC331 x 0.6  
 Min. Size: 13 3/4 x 16 3/4  
 [349.3mm x 415.9mm]

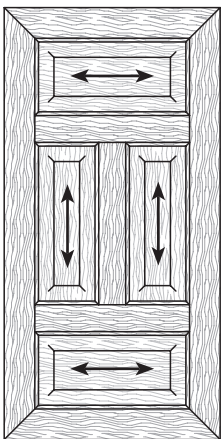

**Style: 8050M**

PC: 332  
 Frame: PC332 x 0.6  
 Min. Size: 13 3/4 x 23  
 [349.3mm x 584.2mm]

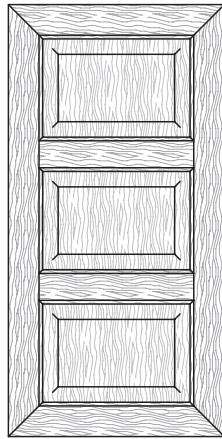

**Style: 8030M**

PC: 308  
 Frame: PC308 x 0.6  
 Min. Size: 8x19 1/2  
 [203.2mm x 495.3mm]

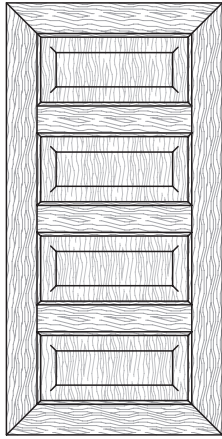

**Style: 2271M**

PC: 315  
 Frame: PC315 x 0.6  
 Min. Size: 8x25 1/4  
 [203.2mm x 641.4mm]

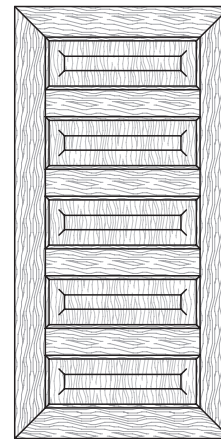

**Style: 2272M**

PC: 317  
 Frame: PC317 x 0.6  
 Min. Size: 8x31  
 [203.2mm x 787.4mm]

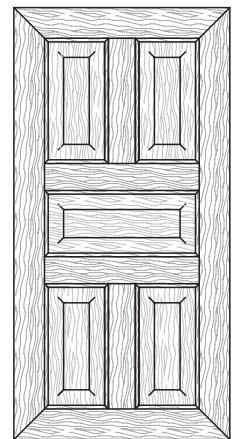

**Style: 2465M**

PC: 336  
 Frame: PC136 x 0.6  
 Min. Size: 13 3/4 x 25  
 [349.3mm x 635mm]

► For PRICING ► See Section B.5 in our current Wholesale Pricing Catalog.

Mitered (Mitre) Mortise & Tenon - Raised Panel

Cabinet Door & Drawer Front Options

B

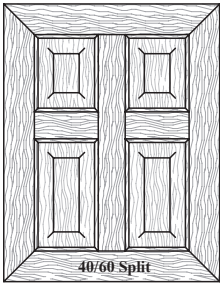

40/60 Split

**Style: 8170M**

PC: 315  
 Frame: PC315 x 0.6  
 Min. Size: 13<sup>3</sup>/<sub>4</sub>x15<sup>1</sup>/<sub>2</sub>  
 [349.3mm x 393.7mm]

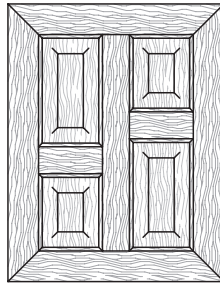

**Style: 8060LM**

PC: 332  
 Frame: PC332 x 0.6  
 Min. Size: 13<sup>3</sup>/<sub>4</sub>x15<sup>1</sup>/<sub>2</sub>  
 [349.3mm x 393.7mm]

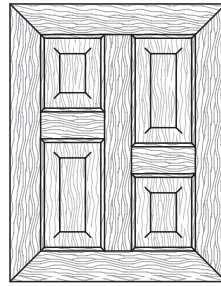

**Style: 8060RM**

PC: 332  
 Frame: PC332 x 0.6  
 Min. Size: 13<sup>3</sup>/<sub>4</sub>x15<sup>1</sup>/<sub>2</sub>  
 [349.3mm x 393.7mm]

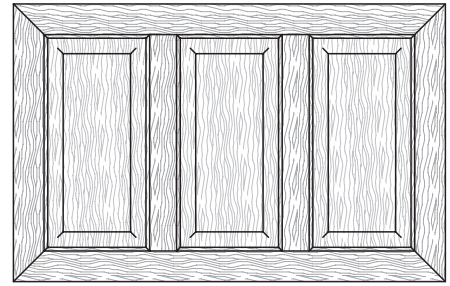

**Style: 8020M**

PC: 308  
 Frame: PC308 x 0.6  
 Min. Size: 19<sup>1</sup>/<sub>2</sub>x8  
 [495.3mm x 203.2mm]

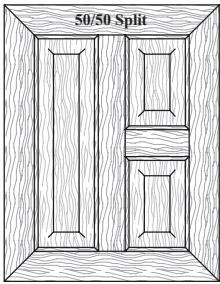

50/50 Split

**Style: 2291LM**

PC: 331  
 Frame: PC331 x 0.6  
 Min. Size: 13<sup>3</sup>/<sub>4</sub>x13<sup>3</sup>/<sub>4</sub>  
 [349.3mm x 349.3mm]

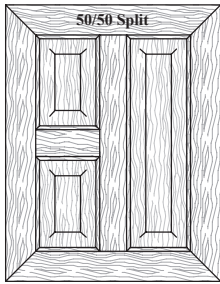

50/50 Split

**Style: 2291RM**

PC: 331  
 Frame: PC331 x 0.6  
 Min. Size: 13<sup>3</sup>/<sub>4</sub>x13<sup>3</sup>/<sub>4</sub>  
 [349.3mm x 349.3mm]

► For PRICING ► See Section B.5 in our current Wholesale Pricing Catalog.

## Ordering &amp; Pricing Notes: Mitered Mortise &amp; Tenon - Raised Panel

## Ordering Guidelines

1	Order Forms	Please use <i>Door and/or Drawer Front Order Forms (E•Z Forms #2 and #3)</i> .
2	Compatibility Charts	For more information regarding the compatibility of miter stile & rail profiles with other WalzCraft products and services, please reference our website under: <b>Resources &gt; Technical Information</b> .
<b>Pricing</b>		
1	Pricing	Please see <i>Section B.5</i> of our current <b>Wholesale Pricing Catalog</b> .

## Technical Notes: Mitered Mortise &amp; Tenon - Raised Panel

## Cabinet Door &amp; Drawer Front Options (Chapter B)

1	Mitered Frame or Mullion Doors	All of the mitered profiles shown in this catalog are also available with the <b>GRF</b> profile. When ordering, please indicate whether the door is a frame or mullion. If a mullion, please indicate the lite pattern and number of lites. <b>Not all mitered profiles are available with mullions.</b>
---	--------------------------------	---

## Convex/Concave Options (Chapter D)

1	Curved Products	The ☐ indicates door styles are available for Curved Products. For ordering guidelines, see <i>Chapter D</i> .
---	-----------------	--

## Design Options (Chapter G)

1	Radius Corners	Mitered profiles in the <b>MP600/MP6000 Series</b> , which accept an additional outside edge, may also accept radius outside corners.
		1½" [38.1mm] wide Mitered Profiles can accept up to a ¾" [19.1mm] radius.
		2¼" [57.2mm] to 4½" [114.3mm] wide Mitered Profiles can accept up to a 1" [25.4mm] radius.
		For more information, please refer to <i>Section G.13</i> .
2	Mitered Stile & Rail Stock (Part #SRP100)	Mitered stile & rail stock is produced and priced the same as Traditional stile & rail stock. To order, use part # <b>SRP100</b> . Available in 8', Random Length and Cut to Length sizes. See <i>Section G.16</i> for additional information.

## Functional Options (Chapter F)

1	Hinge Boring	Hinge boring is available for Mitered Mortise & Tenon - Raised Panel doors and drawer fronts. Please see <i>Section F.1</i> for additional hinge boring requirements, ordering instructions and compatibility.
		Hinge boring is <b>not available</b> on any of the 1½" [38.1mm] wide miter profiles.

## General Information (Chapter A)

1	Grain Direction	Arrows (←→) indicate standard grain direction. Grain direction may be specified at <b>NO extra cost</b> .
2	Ready to Assemble	<b>RTA (Ready to Assemble)</b> is available as an option for mitered doors.
3	Warranty	Please see <i>Section A.8 - Warranties</i> for more information on warping, bowing (i.e.: barrel effect) and twisting.

## Miscellaneous

1	Center Stile and Rail Construction	Most center stiles & rails will be haunched into the outside stiles & rails creating a mitered joint where they are conjoined. Exceptions will apply where the haunch distance is too small to miter. In these cases, a butt joint will be used (eg.: <b>MP612/MP1468</b> ).
---	------------------------------------	--

## Profile Options (Chapter E)

1	D7 Edges	A D7 Edge can be used along with any <b>MP600/MP6000 Series</b> mitered profile that accepts an additional outside edge.
2	Lipped Outside Edge Profiles	<b>D5, D16, D20, D22, D36, D44, D58, D123, D144, D180 outside edges profiles</b> are not available with any mitered construction. These edge treatments will leave a void in the tenon joint on profiles.
3	MP660 Family	Designed to accept applied molding # <b>3149</b> . Molding must be ordered separately.
4	MP744, MP763 Families	Designed to accept applied molding # <b>3253</b> . Molding must be ordered separately.

Continued on next page...

► For **PRICING** ► See *Section B.5* in our current Wholesale Pricing Catalog.

*Technical Notes: Mitered Mortise & Tenon - Raised Panel...continued*

*Sizes/Dimensions*

1	Thicknesses	When using Traditional mitered stile and rail profiles, mitered mortise & tenon raised panel doors and DFs made from solid wood are available ¾" [19.1mm] and 1" [25.4mm] thick.
		When using Old World mitered stile and rail profiles, mitered mortise & tenon raised panel doors and DFs made from solid wood are available 1" [25.4mm], 1⅝" [28.6mm] and 1¼" [31.8mm] thick.
		See <i>Section S.3</i> for possible thickness restrictions based on wood species.
2	Non-Standard Parts	Some mitered profiles accommodate width flexibility, see the <b>MP600/MP6000</b> series of mitered profiles in <i>Section E.9</i> . The top rail, bottom rail, left stile and right stile must all be the same profile and the same width.
		Stiles/Rails can be ordered in widths from 1½" [38.1mm] to 3" [76.2mm] in ¼" [6.4mm] increments without incurring a non-standard part size charge. See <i>Section A.5</i> for more information.
		Please submit requests for widths that range from over 3" [76.2mm] to a maximum 4½" [114.3mm] to our Customer Support Team; these may be subject to up-charges.
3	Minimum Sizes	All mitered door and drawer front minimum sizes are calculated based on 2¼" [57.2mm] wide profiles.
		If using a 3" [76.2mm] wide profile, please add 1½" [38.1mm] to the published minimum door size.
		If using a 1½" [38.1mm] wide profile, deduct 1½" [38.1mm] from the published minimum size.

*Mitered Mortise & Tenon - Raised Panel - END*

► For PRICING ► See Section **B.5** in our current Wholesale Pricing Catalog.

B

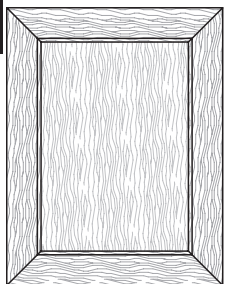

**Style: 40M**

PC: 401  
 Frame: PC301 x 0.6  
 Min. Size: 6x6  
 [152.4mm x 152.4mm]

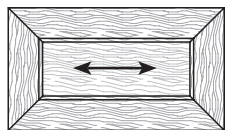

**Style: 40M\***  
**Drawer Front**

PC: 401  
 Frame: PC301 x 0.6  
 Min. Size: 6x6  
 [152.4mm x 152.4mm]  
 Shown with 2 1/4" [57.2mm]  
 stiles & rails

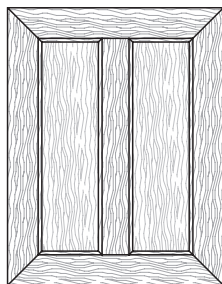

**Style: 4040M**

PC: 403  
 Frame: PC303 x 0.6  
 Min. Size: 9 3/4 x 6 5/8  
 [247.7mm x 168.3mm]

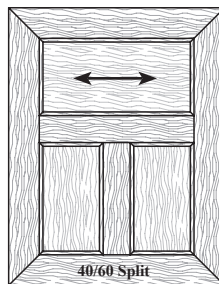

**Style: 3010M**

PC: 431  
 Frame: PC331 x 0.6  
 Min. Size: 9 3/4 x 12  
 [247.7mm x 304.8mm]

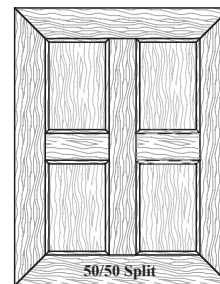

**Style: 3160M**

PC: 415  
 Frame: PC315 x 0.6  
 Min. Size: 9 3/4 x 11  
 [247.7mm x 279.4mm]

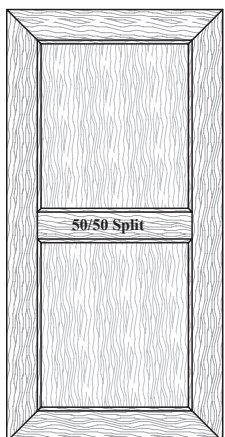

**Style: 4044M**

PC: 403  
 Frame: PC303 x 0.6  
 Min. Size: 6x11  
 [152.4mm x 279.4mm]

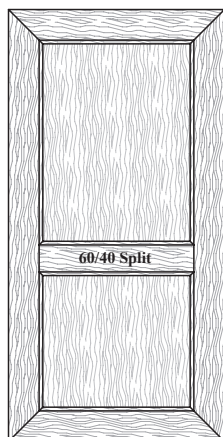

**Style: 4043M**

PC: 403  
 Frame: PC303 x 0.6  
 Min. Size: 6x12  
 [152.4mm x 304.8mm]

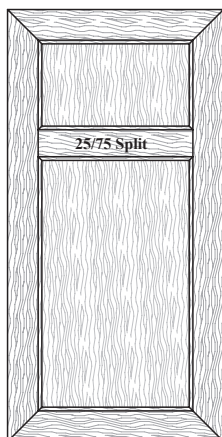

**Style: 4041M**

PC: 403  
 Frame: PC303 x 0.6  
 Min. Size: 6 5/8 x 12 3/4  
 [168.3mm x 323.9mm]



**Style: 4045M**

PC: 403  
 Frame: PC303 x 0.6  
 Min. Size: 6 5/8 x 12 3/4  
 [168.3mm x 323.9mm]



**Style: 2428M**

PC: 431  
 Frame: PC331 x 0.6  
 Min. Size: 9 3/4 x 12 3/4  
 [247.7mm x 323.9mm]

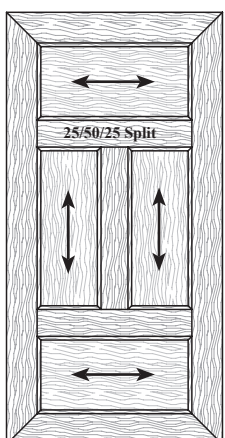

**Style: 4150M**

PC: 432  
 Frame: PC332 x 0.6  
 Min. Size: 9 3/4 x 15  
 [247.7mm x 381mm]

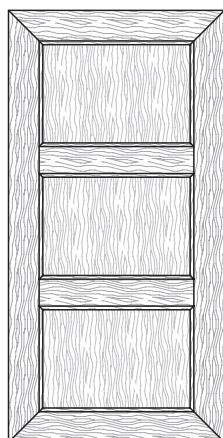

**Style: 4030M**

PC: 408  
 Frame: PC308 x 0.6  
 Min. Size: 6 5/8 x 15 3/4  
 [168.3mm x 390.5mm]

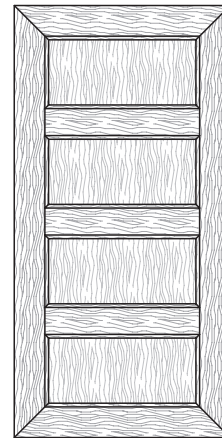

**Style: 3271M**

PC: 415  
 Frame: PC315 x 0.6  
 Min. Size: 6 5/8 x 19 3/4  
 [168.3mm x 501.7mm]

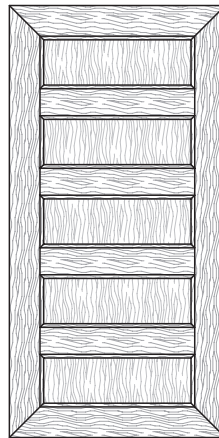

**Style: 3272M**

PC: 417  
 Frame: PC317 x 0.6  
 Min. Size: 6 5/8 x 24 3/4  
 [168.3mm x 612.8mm]

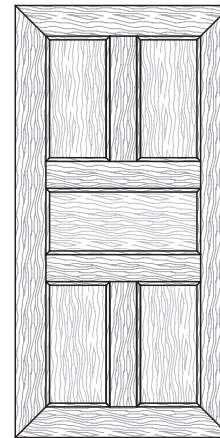

**Style: 3465M**

PC: 436  
 Frame: PC336 x 0.6  
 Min. Size: 9 3/4 x 16 1/2  
 [247.7mm x 419.1mm]

► For PRICING ► See Section B.6 in our current Wholesale Pricing Catalog.

Mitered (*Mitre*) Mortise & Tenon - 1/4" Flat Panel

Cabinet Door & Drawer Front Options

B

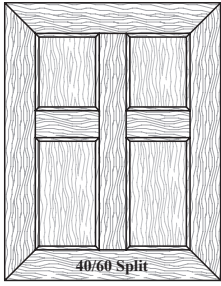

40/60 Split

**Style: 3170M**

**PC: 415**

**Frame: PC315 x 0.6**

**Min. Size: 11x11½**

[279.4mm x 292.1mm]

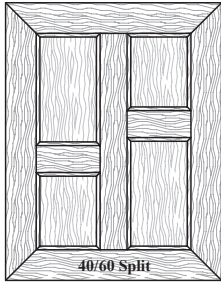

40/60 Split

**Style: 3060LM**

**PC: 432**

**Frame: PC332 x 0.6**

**Min. Size: 11x11¼**

[279.4mm x 285.8mm]

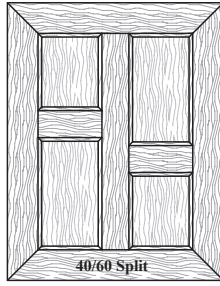

40/60 Split

**Style: 3060RM**

**PC: 432**

**Frame: PC332 x 0.6**

**Min. Size: 11x11¼**

[279.4mm x 285.8mm]

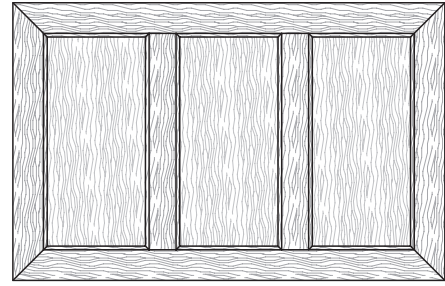

**Style: 4020M**

**PC: 408**

**Frame: PC308 x 0.6**

**Min. Size: 15½x6¾**

[390.5mm x 168.3mm]

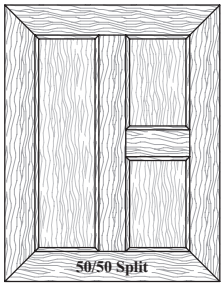

50/50 Split

**Style: 3291LM**

**PC: 431**

**Frame: PC331 x 0.6**

**Min. Size: 11x9¼**

[279.4mm x 247.7mm]

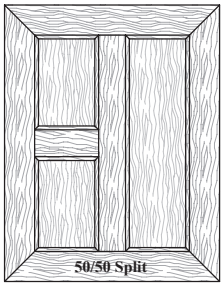

50/50 Split

**Style: 3291RM**

**PC: 431**

**Frame: PC331 x 0.6**

**Min. Size: 11x9¼**

[279.4mm x 247.7mm]

► For PRICING ► See Section B.6 in our current Wholesale Pricing Catalog.

**Ordering & Pricing Notes: Mitered Mortise & Tenon - 1/4" Flat Panel**

**Ordering Guidelines**

1	Order Forms	Please use <b>Door and/or Drawer Front Order Forms (E•Z Forms #2 and #3)</b> .
		When placing an order for a 1/4" Flat Panel door, please indicate the word "Flat" in the space provided for the panel profile on the order form.

<b>Profile Info</b>	
Stile & Rail or Miter Profile	<b>MP609-57</b>
Panel Profile	<b>Flat</b>
Outside Edge Profile	<b>D17</b>

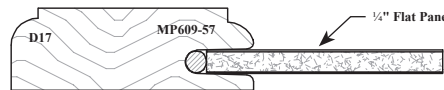

**Pricing**

1	Pricing	Please see <b>Section B.3</b> of the current Wholesale Pricing Catalog.
---	---------	---

**Technical Notes: Mitered Mortise & Tenon - 1/4" Flat Panel**

**Cabinet Door & Drawer Front Options (Chapter B)**

1	Mitered Frame or Mullion Doors	<p>All of the mitered profiles shown in this catalog are also available with the GRF profile.</p> <ul style="list-style-type: none"> <li>• When ordering, please indicate whether the door is a frame or mullion.</li> <li>• If a mullion, please indicate the lite pattern and number of lites.</li> <li>• Not all mitered profiles are available with mullions.</li> </ul>
---	--------------------------------	--

**Convex/Concave Options (Chapter D)**

1	Curved Products	The ☐ indicates door styles are available for Curved Products. For ordering guidelines, see <b>Chapter D</b> .
---	-----------------	--

**Design Options (Chapter G)**

1	Radius Corners	<p>Mitered profiles in the MP600/MP6000 series, which accept an additional outside edge, may also accept radius outside corners.</p> <ul style="list-style-type: none"> <li>• 1 1/2" [38.1mm] wide mitered profiles can accept up to a 3/4" [19.1mm] radius.</li> <li>• 2 1/4" [57.2mm] to 4 1/2" [114.3mm] wide mitered profiles can accept up to a 1" [25.4mm] radius.</li> <li>• For more information, please refer to <b>Section G.13</b>.</li> </ul>
2	Mitered Stile & Rail Stock (Part #SRP100)	<p>Mitered stile &amp; rail stock is produced and priced the same as Traditional stile &amp; rail stock with an outside edge. To order use part #SRP100.</p> <p>Available in 8' [2438.4mm], Random Length and Cut to Length sizes. See <b>Section G.16</b> for additional information.</p>

**Functional Options (Chapter F)**

1	Hinge Boring	<p>Hinge boring is available for Mitered Mortise &amp; Tenon - 1/4" Flat Panel doors and drawer fronts. Please see <b>Section F.1</b> for additional hinge boring requirements, ordering instructions and compatibility.</p> <p>Hinge boring is <b>not available</b> on any of the 1 1/2" [38.1mm] wide miter profiles.</p>
---	--------------	---

**General Information (Chapter A)**

1	Grain Direction	Arrows (←→) indicate standard grain direction. Grain direction may be specified at no additional cost.
2	Ready to Assemble	RTA is available as an option for mitered doors.
3	Warranty	Please see <b>Section A.8 - Warranties</b> for more information on warping, bowing (i.e.: barrel effect) and twisting.

**Material Options**

1	Core Material	Veneered flat panel doors are constructed using a 1/4" [6.4mm] "A" face grade veneer with MDF core.
---	---------------	---

**Miscellaneous**

1	Compatibility Charts	Please reference our website: <b>Resources/Technical Information</b> .
2	Center Stile and Rail Construction	<p>Most center stiles &amp; rails will be haunched into the outside stiles &amp; rails creating a mitered joint where they are conjoined.</p> <ul style="list-style-type: none"> <li>• Exceptions will apply where the haunch distance is too small to miter. In these cases, a butt joint will be used (eg.: MP612/MP1468).</li> </ul>

Continued on next page...

► For PRICING ► See Section B.6 in our current Wholesale Pricing Catalog.

Technical Notes: Mitered Mortise & Tenon - 1/4" Flat Panel...continued

Profile Options (Chapter E)...continued

1	1/4" Flat Panel Doors and Drawers Fronts	1/4" Flat Panel doors are available with 1/4" veneered MDF core plywood or 1/4" raw MDF center panels. If wanting the look of a flat panel door, but with a solid wood center panel, choose your door style from <i>Section B.1</i> and select the <b>RVSCP-PR324</b> reversed center panel profile from <i>Section E.13</i> . • For pricing, please see <i>Section B.1</i> of our current <i>Wholesale Pricing Catalog</i> .
2	D7 Edges	A D7 Edge can be used along with any <b>MP600/MP6000</b> series mitered profile that accepts additional outside edges.
3	Lipped Outside Edge Profiles	<b>D5, D16, D20, D22, D36, D44, D58, D123, D144, D180</b> outside edge profiles are not available with any mitered construction. • These edge treatments will leave a void in the tenon joint on profiles.
4	MP623-76, MP623-57, MP623-38	Only available in 3/4" [19.1mm] thickness. To obtain a center panel that is flush with the face of the stiles and rails, use one of these Solid Wood Center Panel Profiles: <b>PR318-25, PR319-10, PR320-25, PR320-32, PR320-44, PR321-32, PR328-32</b> or <b>PR329-19</b> .
5	MP624-76, MP624-57 and MP624-38	Available in 3/4" [19.1mm] or 1" [25.4mm] thicknesses with a 1/4" [6.4mm] Veneered Flat Panel or these Solid Wood Profiles: <b>PR318-25, PR320-25, PR320-32, PR320-44, PR321-32, PR328-32, PR329-19</b> or the <b>RVSCP-PR324 (Reversed Solid Center Panel)</b> .
6	MP660 Family	Designed to accept applied molding <b>#1169</b> and <b>#3149</b> . Molding must be ordered separately.
7	MP744, MP763 Families	Designed to accept applied molding <b>#3253</b> . Molding must be ordered separately.

Sizes/Dimensions

1	Thicknesses	When using Traditional mitered stile and rail profiles, mitered mortise & tenon 1/4" flat panel doors and DFs made from solid wood are available 3/4" [19.1mm] and 1" [25.4mm] thick. When using Old World mitered stile and rail profiles, mitered mortise & tenon 1/4" flat panel doors and DFs made from solid wood are available 1" [25.4mm], 1 1/8" [28.6mm] and 1 1/4" [31.8mm] thick. See <i>Section S.3</i> for possible thickness restrictions based on wood species.
2	Non-Standard Parts	Some mitered profiles accommodate width flexibility, see the <b>MP600/MP6000</b> series of mitered profiles in <i>Section E.9</i> . The top rail, bottom rail, left stile and right stile must all be the same profile and the same width. Stiles/Rails can be ordered in widths from 1 1/2" [38.1mm] to 3" [76.2mm] in 1/4" [6.4mm] increments without incurring a non-standard part size charge. See <i>Section A.5</i> for more information. Please submit requests for widths that range from over 3" [76.2mm] to a maximum 4 1/2" [114.3mm] to our Customer Support Team; these may be subject to up-charges.
3	Minimum Sizes	All mitered door and drawer front minimum sizes are calculated based on 2 1/4" [57.2mm] wide profiles. If using a 3" [76.2mm] wide profile, please add 1 1/2" [38.1mm] to the published minimum door size. If using a 1 1/2" [38.1mm] wide profile, deduct 1 1/2" [38.1mm] from the published minimum size.
4	Maximum Center Panel Size Limitation	Given the 1/4" [6.4mm] veneered flat panel material used for center panels is 48"W x 96"H [1219.2mm x 2438.4mm], the maximum visible center panel width in a door with vertical grain and no center stile is 47 7/8" [1197mm]; the maximum visible center panel height with no center rail is 95 1/8" [2416.2mm].

Mitered Mortise & Tenon - 1/4" Flat Panel - END

► For PRICING ► See Section **B.6** in our current Wholesale Pricing Catalog.

French Miter Joinery Benefits

Our *French Miter* door construction was introduced in an effort to be a more cost effective alternative to an applied molding door. However, the *French Miter* door has other advantages as well. It provides more structural integrity than an applied molding door because the molding detail is an integral part of the stiles and rails instead of a separate piece. It provides a more traditional look than a formal mitered door while still having the applied molding look. If in extremely dry or humid regions, WalzCraft recommends the use of French Miter doors & drawer fronts. The door will be less likely to “barrel” than a traditional miter door (see **Warranty on Bowing** in *Section A.8* for more information on the “barrel effect”). There are more outside edge profile options available than with a mitered door, and you have the flexibility to vary your stile and rail widths.

**Drawer Front Style 40FM\***  
 Shown with: MP604-76, 3" [76mm] Wide Stiles;  
 MP604-57, 2 1/4" [57mm] Wide Rails  
 Flat Center Panel and D79 Outside Edge

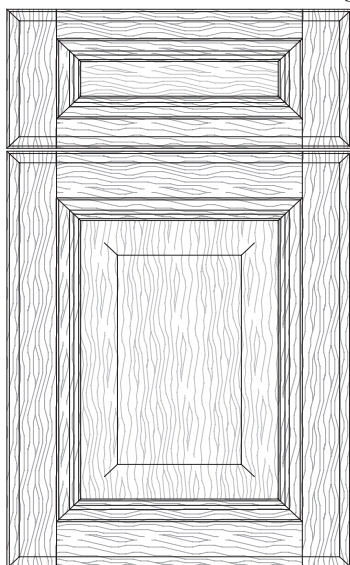

**Door Style 10FM**  
 Shown with: MP604-76,  
 3" [76.2mm] Wide Stiles & Rails  
 PR302-38 and D79 Outside Edge

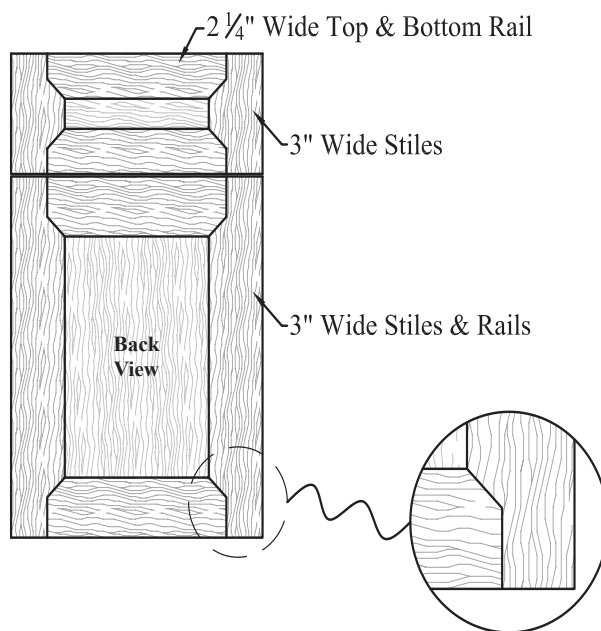

Not drawn to scale.

Ordering & Pricing Notes: French Miter Doors and Drawer Fronts

Ordering Guidelines

1	Order Forms	Please use <i>Door and/or Drawer Front Order Forms (E•Z Forms #2 and #3)</i> .
<b>Pricing</b>		
1	Pricing	Please see <i>Section B.7</i> of our current <b>Wholesale Pricing Catalog</b> .

Continued on next page...

► For PRICING ► See Section B.7 in our current Wholesale Pricing Catalog.

**Technical Notes: French Miter Doors and Drawer Fronts**

**Cabinet Door & Drawer Front Options (Chapter B)**

1	Door Styles	Available in all of the same door styles as the raised and flat panel mitered doors. Simply add an "FM" to the style number (ie: <b>Style 10FM</b> ). See <b>Sections B.5 and B.6</b> .
		Convex/Concave door styles <b>10FM</b> and <b>10FM*</b> are only available in radii 12" [304.8mm] and greater.
		French Miter construction is only available on door styles with a square frame (Ex: Style 10). Not available on doors styles with shaped rails (Ex: Style 2000).
2	Frames & Mullions	<p>Please reference Frame &amp; Mullion notes &amp; glass size calculation in <b>Section B.12</b> when calculating the visual opening size and/or glass size for doors with French Miter construction.</p> <ul style="list-style-type: none"> <li>See <b>Sizes/Dimensions</b> notes on the following page when determining finished stile and rail widths for French Miter doors need for the above calculations.</li> </ul>

**Functional Options (Chapter F)**

1	Hinge Boring	Hinge boring is available for French Miter Mortise & Tenon - Raised & 1/4" Flat Panel doors and drawer fronts. Please see the <b>Outside Edge Profile Compatibility</b> chart on our website: <b>Resources/Technical Information</b> for compatible profile options.
		The minimum width, at the narrowest point, for any stile or rail with 35mm hinge boring, without a "GRF" cut is 1 1/4" [44.5mm]. French Mitered doors ordered with this part size minimum will be limited to a Cup Drilling Distance of 3.0mm or less.

**General Information (Chapter A)**

1	Ready to Assemble (RTA)	RTA ( <i>Ready to Assemble</i> ) is available as an option.
---	-------------------------	---

**Profile Options (Chapter E)**

1	Stile & Rail Profiles	French Mitered doors are available with many of our <b>MP600/MP6000</b> Series Mitered Profiles. Please see <b>Section E.9</b> . Any <b>MP600/MP6000</b> series profile number that has a corresponding <b>[FM]</b> symbol is available for a French Miter door.
		French Miter doors are also available with some of our "Traditional" Mortise & Tenon Stile & Rail profiles. Please see <b>Section E.1</b> . Any profile number that has a corresponding <b>[R-FM]</b> symbol is recommended for French Miter construction. If choosing to order these <b>R-FM</b> profiles with French Miter construction, please use the matching French Miter door style along with the matching miter profile. For example, if you want a Style 10 door with stile & rail profile <b>SR119</b> , but made with French Miter construction, please order door Style <b>10FM</b> with mitered stile & rail profile <b>MP603-57, Page E.9.2</b> .
		<b>SR108</b> matches <b>MP618-57</b> , <b>SR119</b> matches <b>MP603-57</b> , <b>SR121</b> matches <b>MP626-57</b> , <b>SR127</b> matches <b>MP637-57</b> , <b>SR160</b> matches <b>MP690-57</b> .
2	Outside Edge Profiles	Available with most outside edge profiles found in <b>Section E.15 &amp; E.16</b> .
		<ul style="list-style-type: none"> <li>Exceptions will apply where thicknesses are not compatible.</li> </ul> Not compatible with Molder Edge profiles.
3	1/4" Flat Panel Doors and Drawers Fronts	1/4" Flat Panel doors are available with 1/4" veneered or <b>MDF</b> center panels.
		To simulate the look of a 1/4" Flat Panel door or drawer front in a solid wood species, <b>please order using a solid wood raised panel door style</b> with the <b>RVSCP-PR324</b> center panel profile. <ul style="list-style-type: none"> <li>See <b>Section B.5</b> for mitered raised panel door and drawer front styles.</li> <li>See <b>Section E.13</b> for the <b>RVSCP-PR324</b> center panel profile.</li> <li>For pricing, please see <b>Section B.7/B.5</b> of our current <b>Wholesale Pricing Catalog</b>.</li> </ul>

Continued on next page...

► For PRICING ► See Section B.7 in our current Wholesale Pricing Catalog.

Technical Notes: French Miter Doors and Drawer Fronts...continued

Sizes/Dimensions

1	Thicknesses	When using French Mitered stile and rail profiles, French Mitered Mortise & Tenon raised panel and 1/4" flat panel doors and DFs made from solid wood are available 3/4" [19.1mm] and 1" [25.4mm] thick.
		See <b>Section S.3</b> for possible thickness restrictions based on wood species.
2	Minimum & Maximum Sizes	The minimum width for your French Miter door varies and is based on the stile and rail profile guidelines you've chosen. Please contact our Customer Support Team for more information.
		The minimum height for your French Miter door will be the same minimum height as the Mitered Door Style you've chosen.
		The maximum height for a door using French Mitered construction is 96" [2438.4mm].
		The minimum visual rail length for doors with French Miter construction is 5 1/2" [139.7mm].
		The minimum width for any stile and/or rail on a French Miter door is 1 1/2" [38.1mm].
		The maximum width for any stile and/or rail on a French Miter door is 9 5/16" [230.0mm], which will finish at 9" [228.5mm] as noted in the <i>Miter Profile Sizing</i> notes below.
		French Miter doors with any of the following would require non-standard construction:
		<ul style="list-style-type: none"> <li>• Doors greater than 96" [2438.4mm] high.</li> <li>• Rails less than 5 1/2" [139.7mm] long.</li> <li>• Stiles and/or rails greater than 9 5/16" [230.0mm] wide.</li> </ul>
		Please submit these requests to our Customer Support Team. A quote will be provided, as additional charges may apply.
3	Standard & Non-Standard Stile & Rail Widths	Standard stile & rail widths for French Miter doors utilizing Traditional ( <b>E.1</b> ) profiles will be 2 1/4" [57mm] unless otherwise specified.
		Standard stile & rail widths for French Miter doors utilizing Miter ( <b>E.9</b> ) profiles will be either 3" [76mm], 2 1/4" [57mm] or 1 1/2" [38mm] unless otherwise specified. Standard widths are determined by the profile number. If ordering stile & rail widths at their standard sizes, please note the full MP profile number on the order form.
		<ul style="list-style-type: none"> <li>• Example: <b>MP604-76 Stiles</b></li> <li>• Example: <b>MP604-57 Rails</b></li> </ul>
		If you choose to deviate from the standard profile width, please include the first set of numbers of the MP profile ( <b>MP604</b> ) with the width dimension you prefer formatted after the hyphen (-).
		<ul style="list-style-type: none"> <li>• Example: <b>MP604 - 2 3/4"</b></li> <li>• Example: <b>MP604 - 70mm</b></li> </ul>
		Indicate any non-standard part sizes in the <b>Special Instructions</b> column on your order forms.
		All standard and non-standard part size rules apply. See <b>Section A.5</b> for more information.
4	Miter Profile Sizing	Due to the manufacturing process, outside stiles and rails for French Miter doors utilizing miter profiles will finish at 1/16" [1.5mm] less in width than what is denoted by the stile and rail profile number.
		<ul style="list-style-type: none"> <li>• For example, a French Miter door that is ordered with stile &amp; rail profile <b>MP604-76</b>, will have outside stiles and rails that finish at 2 5/16" [74.5mm] wide rather than 3" [76mm].</li> </ul>
		<ul style="list-style-type: none"> <li>◦ To result in a "true" 3" [76mm] wide stile &amp; rail width, the outside stile and rail sizes must be ordered at 3 1/16" [77.50mm], rather than 3" [76mm].</li> </ul>
		The same would apply for outside stile and rail widths specified that deviate from the widths denoted by the profile number.
		<ul style="list-style-type: none"> <li>• For example, if ordering a French Miter door with stile &amp; rail profile <b>MP604</b>, and you specify the outside stiles and rails to be 2 3/4" [70mm] wide, they will finish at 2 1/16" [68.5mm] wide rather than 2 3/4" [70mm].</li> </ul>
		<ul style="list-style-type: none"> <li>◦ To result in a "true" 2 3/4" [70mm] wide stile &amp; rail width, the outside stile and rail sizes must be ordered at 2 13/16" [71.50mm], rather than 2 3/4" [70mm].</li> </ul>
		Center stiles and center rails for French Miter construction will finish at specified dimensions.
5	Flat Panel Door Maximum Sizes	The 1/4" [6.4mm] veneered flat panel material used for center panels is 48"W x 96"H [1219.2mm x 2438.4mm]. Due to this, the maximum visible center panel <u>width</u> in a door with vertical grain and no center stile is 47 7/8" [1197mm]. The maximum visible center panel <u>height</u> with no center rail is 95 5/8" [2416.2mm].

French Miter Mortise & Tenon Raised & 1/4" Flat Panel Doors and Drawer Fronts - END

► For PRICING ► See Section **B.7** in our current Wholesale Pricing Catalog.



Adventure Series Construction

The *Adventure Series* door style was introduced to give you more design flexibility to create a truly unique look. This series of doors allows you to pair a square edged stile or rail profile with any of the profiles from *Sections E.1, E.3, E.5* or *E.9* designated with an **AS**. See *Profile* notes on following pages for more information.

With **Styles 10ASTP, 1801ASTP, 40ASTP and 1401ASTP** you can either apply a detailed profile to the rails while keeping the stiles square, or reverse the construction and apply a detailed profile to the stiles while keeping the rails square.

- For **Styles 8000ASTP, 1000ASTP, 3098ASTP, 3101ASTP, 4044ASTP, 4043ASTP, 3097ASTP, 3099ASTP, 10ASMP, 8000ASMP, 1000ASMP, 40ASMP, 4044ASMP and 4043ASMP** you can apply a detailed profile to the rails while keeping the stiles square.
- For **Styles 1010ASTP, 3096ASTP, 4040ASTP, 3095ASTP, 1801ASMP, 3096ASMP, 1401ASMP and 3095ASMP** you can apply a detailed profile to the stiles while keeping the rails square.

The mortise & tenon construction even allows you to vary the stile & rail widths for more flexibility.

**Step 1)** Choose your door style. This will define the center panel type (raised or flat), how your stiles and rails will intersect, and what type of profile (traditional vs. miter) can be used.

**Step 2)** Choose the profile that you want applied to the detailed stiles or detailed rails.

- **Example: Style 10ASMP** will give you a square raised panel. The stiles will run the full height of the door with the rails running between the stiles. The detailed profile on the rails can be chosen from any of the mitered profiles in *Section E.9* that have a corresponding **AS** on the profile drawing.
- The example below shows a **Style 10ASMP** with the **MP643-57** profile applied to the *rails*.

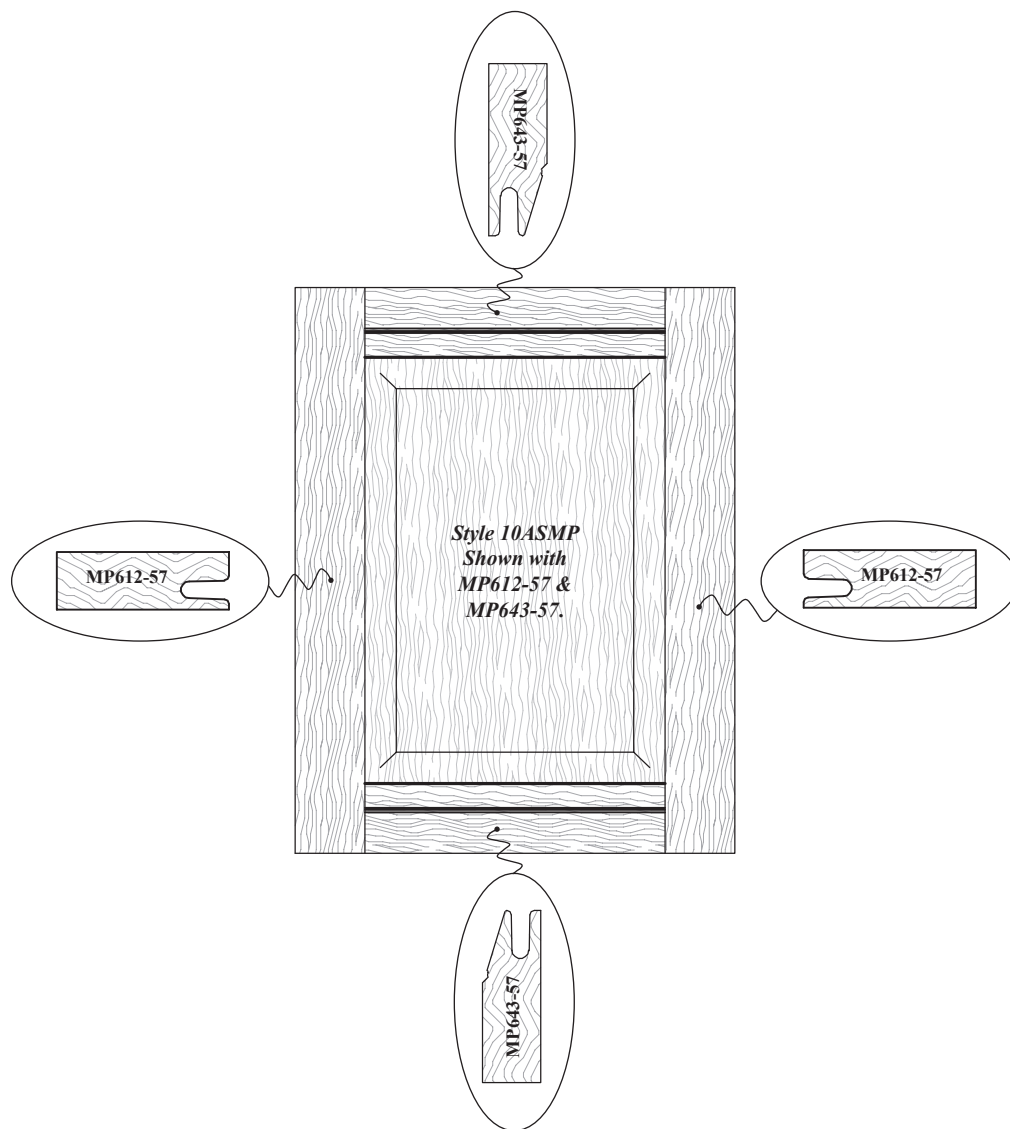

Not drawn to scale.

► For PRICING ► See Section [B.7](#) in our current Wholesale Pricing Catalog.

Adventure Series Door Styles - Raised Panel - Traditional Profiles (ASTP)

\*\* Available with many profiles from Sections E.1, E.3 and E.5. See notes on the following pages for more information. \*\*

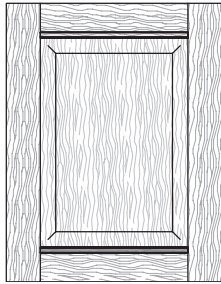

**Style: 10ASTP**  
 PC: 101  
 Frame: PC101 x 0.6  
 Min. Size: 8x8  
 [203.2mm x 203.2mm]

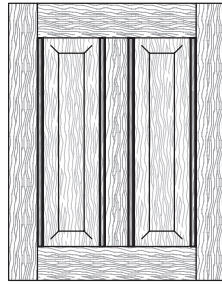
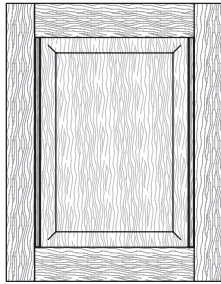

**Style: 1010ASTP**  
 PC: 103  
 Frame: PC103 x 0.6  
 Min. Size: 13 3/4 x 8  
 [349.3mm x 203.2mm]



**Style: 8000ASTP**  
 PC: 103  
 Frame: PC103 x 0.6  
 Min. Size: 8x13 3/4  
 [203.2mm x 349.3mm]

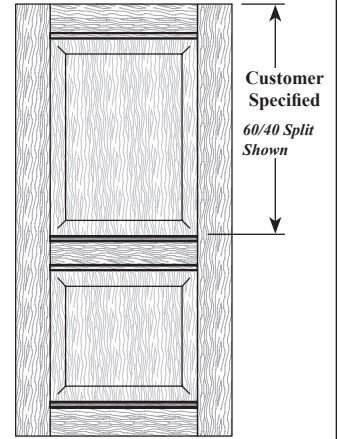

**Style: 1000ASTP**  
 PC: 103  
 Frame: PC103 x 0.6  
 Min. Size: 8x13 3/4  
 [203.2mm x 349.3mm]

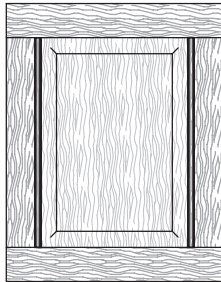

**Style: 1801ASTP**  
 PC: 101  
 Frame: PC101 x 0.6  
 Min. Size: 8x8  
 [203.2mm x 203.2mm]

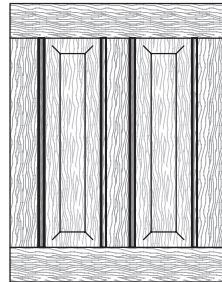
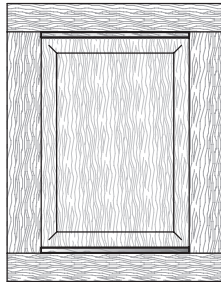

**Style: 3096ASTP**  
 PC: 103  
 Frame: PC103 x 0.6  
 Min. Size: 13 3/4 x 8  
 [349.3mm x 203.2mm]



**Style: 3098ASTP**  
 PC: 103  
 Frame: PC103 x 0.6  
 Min. Size: 8x13 3/4  
 [203.2mm x 349.3mm]

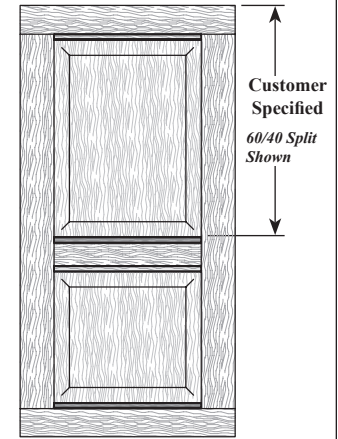

**Style: 3101ASTP**  
 PC: 103  
 Frame: PC103 x 0.6  
 Min. Size: 8x13 3/4  
 [203.2mm x 349.3mm]



Profiled edges shown using SR153  
 (Profile not drawn to full scale)

► For PRICING ► See Section **B.7** in our current Wholesale Pricing Catalog.

Adventure Series Door Styles - 1/4" Flat Panel - Traditional Profiles (ASTP)

\*\* Available with many profiles from Sections E.1, E.3 and E.5. See notes on the following pages for more information. \*\*

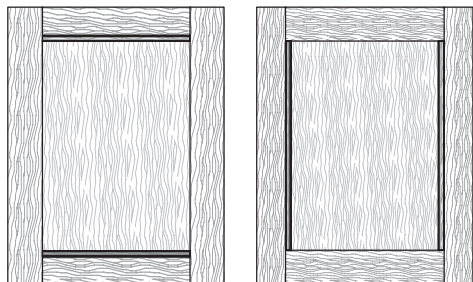

**Style: 40ASTP**  
 PC: 201  
 Frame: PC101 x 0.6  
 Min. Size: 6"x6"  
 [168.3mm x 152.4mm]

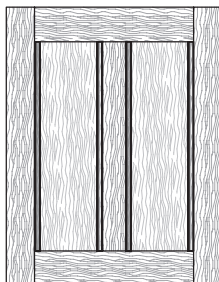

**Style: 4040ASTP**  
 PC: 203  
 Frame: PC103 x 0.6  
 Min. Size: 9"x6"  
 [247.7mm x 168.3mm]

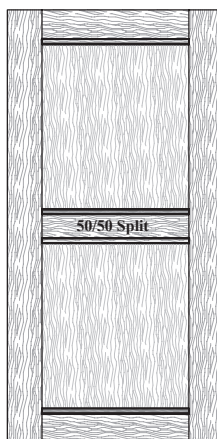

**Style: 4044ASTP**  
 PC: 203  
 Frame: PC103 x 0.6  
 Min. Size: 6"x9 3/4"  
 [168.3mm x 247.7mm]

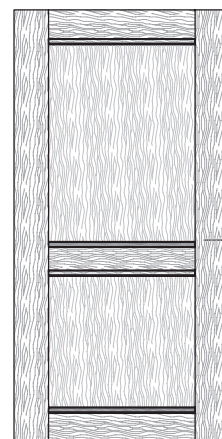

**Style: 4043ASTP**  
 PC: 203  
 Frame: PC103 x 0.6  
 Min. Size: 6"x9 3/4"  
 [168.3mm x 247.7mm]

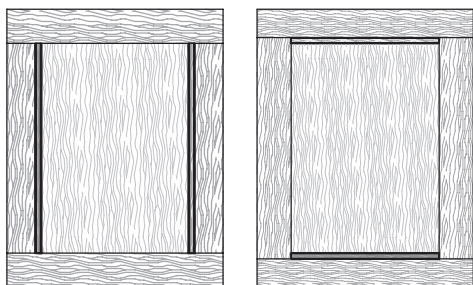

**Style: 1401ASTP**  
 PC: 201  
 Frame: PC101 x 0.6  
 Min. Size: 6"x6"  
 [168.3mm x 152.4mm]

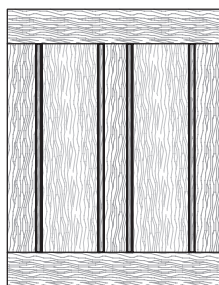

**Style: 3095ASTP**  
 PC: 203  
 Frame: PC103 x 0.6  
 Min. Size: 9"x6"  
 [247.7mm x 168.3mm]



**Style: 3097ASTP**  
 PC: 203  
 Frame: PC103 x 0.6  
 Min. Size: 6"x9 3/4"  
 [168.3mm x 247.7mm]

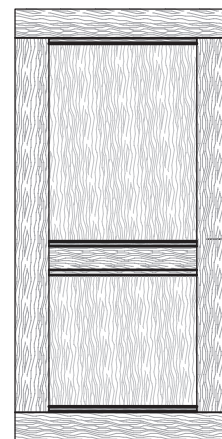

**Style: 3099ASTP**  
 PC: 203  
 Frame: PC103 x 0.6  
 Min. Size: 6"x9 3/4"  
 [168.3mm x 247.7mm]



Profiled edges shown using SR153  
 (Profile not drawn to full scale)

► For PRICING ► See Section B.7 in our current Wholesale Pricing Catalog.

Adventure Series Door Styles - Raised Panel - Miter Profiles (ASMP)

\*\* Available with many profiles from Section E.9. See notes on the following pages for more information. \*\*

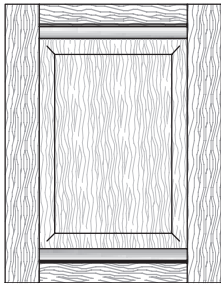

**Style: 10ASMP**  
 PC: 301  
 Frame: PC301 x 0.6  
 Min. Size: 8x8  
 [203.2mm x 203.2mm]

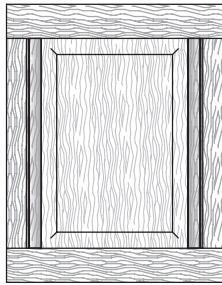

**Style: 1801ASMP**  
 PC: 301  
 Frame: PC301 x 0.6  
 Min. Size: 8x8  
 [203.2mm x 203.2mm]

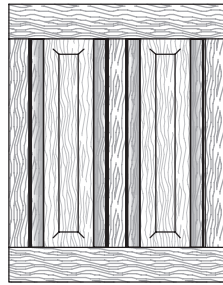

**Style: 3096ASMP**  
 PC: 303  
 Frame: PC303 x 0.6  
 Min. Size: 13 3/4 x 8  
 [349.3mm x 203.2mm]



**Style: 8000ASMP**  
 PC: 303  
 Frame: PC303 x 0.6  
 Min. Size: 8x13 3/4  
 [203.2mm x 349.3mm]

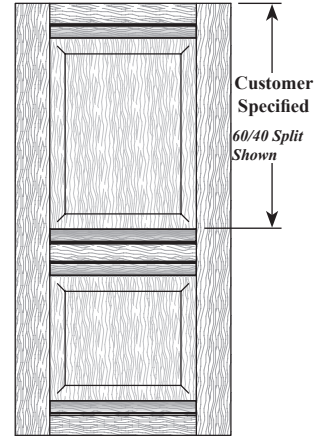

**Style: 1000ASMP**  
 PC: 303  
 Frame: PC103 x 0.6  
 Min. Size: 8x15 1/2  
 [203.2mm x 393.7mm]



Profiled edges shown using MP643-57  
 (Profile not drawn to full scale)

Adventure Series Door Styles - 1/4" Flat Panel - Miter Profiles (ASMP)

\*\* Available with many profiles from Section E.9. See notes on the following pages for more information. \*\*

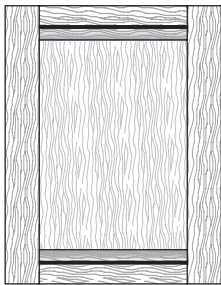

**Style: 40ASMP**  
 PC: 401  
 Frame: PC301 x 0.6  
 Min. Size: 6 5/8 x 6  
 [168.3mm x 152.4mm]

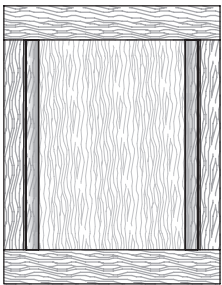

**Style: 1401ASMP**  
 PC: 401  
 Frame: PC301 x 0.6  
 Min. Size: 6 5/8 x 6  
 [168.3mm x 152.4mm]

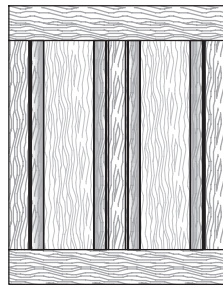

**Style: 3095ASMP**  
 PC: 403  
 Frame: PC303 x 0.6  
 Min. Size: 9 3/4 x 6 5/8  
 [247.7mm x 168.3mm]

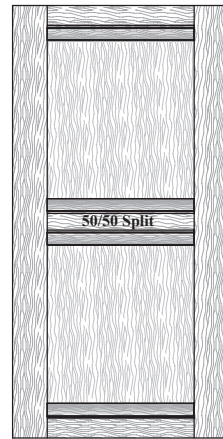

**Style: 4044ASMP**  
 PC: 403  
 Frame: PC303 x 0.6  
 Min. Size: 6 5/8 x 9 3/4  
 [168.3mm x 247.7mm]

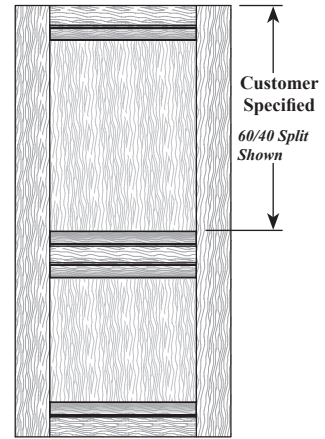

**Style: 4043ASMP**  
 PC: 403  
 Frame: PC303 x 0.6  
 Min. Size: 6 5/8 x 11 1/4  
 [168.3mm x 285.8mm]

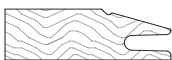

Profiled edges shown using MP643-57  
 (Profile not drawn to full scale)

► For PRICING ► See Section B.7 in our current Wholesale Pricing Catalog.

**Ordering & Pricing Notes: Adventure Series - Raised & 1/4" Flat Panel**

**Ordering Guidelines**

<b>1</b>	<b>Order Forms</b>	Please use <i>Adventure Series Order Form (E-Z Form #2.7)</i> .
<b>Pricing</b>		
<b>1</b>	<b>Pricing</b>	Please see <i>Section B.7</i> of our current <b>Wholesale Pricing Catalog</b> .

**Technical Notes: Adventure Series - Raised & 1/4" Flat Panel**

**Cabinet Door & Drawer Front Options (Chapter B)**

<b>1</b>	<b>Available Door Styles</b>	Available with traditional profiles and raised panel door <b>Styles 10, 1000, 1010, 1801, 8000</b> . Simply add an <b>ASTP</b> to the style number (ex: <b>Style 10ASTP</b> ). <ul style="list-style-type: none"> <li>• Also available as <b>Style 3096ASTP, 3098ASTP, 3101ASTP</b> for Adventure Series doors only.</li> </ul>
		Available with miter profiles and raised panel door <b>Styles 10, 1000, 1801, 8000</b> . Simply add an <b>ASMP</b> to the style number (ex: <b>Style 10ASMP</b> ). <ul style="list-style-type: none"> <li>• Also available as <b>Style 3096ASMP</b> for Adventure series doors only.</li> </ul>
		Available with traditional profiles and flat panel door <b>Styles 40, 1401, 4040, 4043, 4044</b> . Simply add an <b>ASTP</b> to the style number (ex: <b>Style 40ASTP</b> ). <ul style="list-style-type: none"> <li>• Also available as <b>Style 3095ASTP, 3097ASTP, 3099ASTP</b> for Adventure series doors only.</li> </ul>
		Available with miter profiles and flat panel door <b>Styles 40, 1401, 4043, 4044</b> . Simply add an <b>ASMP</b> to the style number (ex: <b>Style 40ASMP</b> ). <ul style="list-style-type: none"> <li>• Also available as <b>Style 3095ASMP</b> for Adventure series doors only.</li> </ul>

**Functional Options (Chapter F)**

<b>1</b>	<b>Hinge Boring</b>	Hinge boring is available for Adventure Series - Raised & 1/4" Flat Panel doors and drawer fronts. Please see <i>Section F.1</i> for additional hinge boring requirements, ordering instructions and compatibility.
----------	---------------------	---

**General Information (Chapter A)**

<b>1</b>	<b>Center Rail Placement</b>	For styles <b>8000ASTP, 3098ASTP, 4044ASTP, 3097ASTP, 8000ASMP</b> and <b>4044ASMP</b> , center rail placement will be standard at a 50/50 split.
		For a center rail placement other than a 50/50 split, please order as <b>Style 1000ASTP, 3101ASTP, 4043ASTP, 3099ASTP, 1000ASMP</b> or <b>4043ASMP</b> . These styles require center rail placement to be specified and refers to the distance from the top of the top rail to the top of the center rail. Please indicate this dimension in the special instructions area on the order form.
<b>2</b>	<b>Ready to Assemble (RTA)</b>	RTA is available as an option.

**Profile Options (Chapter E)**

<b>1</b>	<b>Traditional Profile (ASTP)</b>	This style is available with many of our stile & rail profiles from the following sections: <ul style="list-style-type: none"> <li>• <b>Section E.1:</b> Traditional mortise &amp; tenon stile &amp; rail profiles.</li> <li>• <b>Section E.3:</b> Old World - Traditional mortise &amp; tenon stile &amp; rail profiles.</li> <li>• <b>Section E.5:</b> Shelf applied molding stile &amp; rail profiles.</li> </ul> Any profile number that has a corresponding <b>[AS]</b> symbol is available for an <b>Adventure Series</b> door. Additional approved profile combinations not marked in catalog: <ul style="list-style-type: none"> <li>• Door styles <b>10ASTP &amp; 40ASTP:</b> <b>SR108</b> stiles with <b>SR152</b> rails.</li> <li>• Door styles <b>1801ASTP &amp; 1401ASTP:</b> <b>SR152</b> stiles with <b>SR108</b> rails.</li> </ul>
		This style is available with many of our stile & rail profiles from the following section: <ul style="list-style-type: none"> <li>• <b>Section E.9:</b> <b>MP600 / MP6000</b> series mitered stile &amp; rail profiles.</li> </ul> Any profile number that has a corresponding <b>[AS]</b> symbol is available for an <b>Adventure Series</b> door. Additional approved profile combinations not marked in catalog: <ul style="list-style-type: none"> <li>• Door styles <b>10ASMP &amp; 40ASMP:</b> <b>MP618</b> stiles with <b>MP672</b> rails.</li> <li>• Door styles <b>1801ASMP &amp; 1401ASMP:</b> <b>MP672</b> stiles with <b>MP618</b> rails.</li> </ul>
<b>3</b>	<b>Square Stiles &amp; Rails</b>	Your chosen stile or rail profile can only be used in conjunction with an adjacent square stile or rail, unless noted otherwise. <ul style="list-style-type: none"> <li>• If your rails are profiled, your stiles will be square.</li> <li>• If your stiles are profiled, your rails will be square.</li> </ul>
		<b>SR100</b> is the square profile used with the majority of compatible traditional mortise & tenon ( <b>Section E.1</b> ) and shelf applied molding ( <b>Section E.5</b> ) profiles. <ul style="list-style-type: none"> <li>• Due to the Panel Plow Groove Cut (PPGC) location, <b>SR118</b> will use the <b>SR104</b> square profile.</li> <li>• <b>SR145, SR146, SR157, SR160, SR163, SR167, SR169</b> will use the <b>SR123</b> square profile.</li> </ul>
		<b>SR195</b> is the square profile used with the compatible Old World mortise & tenon profiles ( <b>Section E.3</b> ).
		<b>MP612</b> is the square profile family used with the majority of compatible <b>MP600/MP6000</b> series mitered mortise & tenon stile & rail profiles ( <b>Section E.9</b> ). <ul style="list-style-type: none"> <li>• Due to the Panel Plow Groove Cut (PPGC) location, <b>MP690, MP6112, MP6114</b> will use the <b>MP628</b> square profile.</li> </ul>

Continued on next page...

► For **PRICING** ► See *Section B.7* in our current Wholesale Pricing Catalog.

Technical Notes: Adventure Series - Raised & 1/4" Flat Panel...continued

Profile Options (Chapter E)...continued

4	1/4" Flat Panel Doors and Drawers Fronts	<p>1/4" Flat Panel doors are available with 1/4" veneered or MDF center panels.</p> <p>To simulate the "look" of a "Flat Panel" door or drawer front in a solid wood species, <b>please order using a solid wood raised panel door style</b> with the RVSCP-PR324 center panel profile. See <b>Section B.1</b> for Raised Panel Door &amp; Drawer Front Styles and <b>Section E.13</b> for the RVSCP-PR324 center panel profile. For pricing, please see <b>Section B.1</b> of our current <i>Wholesale Pricing Catalog</i>.</p>
5	Outside Edge Profiles	<p>Available with most Outside Edge Profiles from <b>Sections E.15 &amp; E.16</b>. Please see "Outside Edge Profile Compatibility" chart and/or "Profile-Reveal Widths" chart on our website for more information.</p>

Sizes/Dimensions

1	Thicknesses	<p>When using Traditional stile and rail profiles, Adventure Series raised and 1/4" flat panel doors made from solid wood are available 3/4" [19.3mm] and 1" [25.4mm] thick.</p> <p>When using Mitered stile and rail profiles, Adventure Series raised and 1/4" flat panel doors made from solid wood are available 3/4" [19.1mm] and 1" [25.4mm] thick.</p> <p>When using Old World stile and rail profiles, Adventure Series raised and 1/4" flat panel doors made from solid wood are available 1" [25.4mm], 1 1/8" [28.6mm] and 1 1/4" [31.8mm] thick.</p> <p>See <b>Section S.3</b> for possible thickness restrictions based on wood species.</p>
2	Standard & Non-Standard Stile & Rail Widths	<p>Modification of stile and rail widths is allowed. <b>Adventure Series</b> construction also gives you the flexibility to vary your stile widths from your rail widths.</p> <p>Standard stile &amp; rail widths for <b>Adventure Series</b> doors utilizing Traditional (<b>E.1</b>) or Shelf Applied (<b>E.5</b>) profiles will be 2 1/4" [57mm] unless otherwise specified.</p> <p>Standard stile &amp; rail widths for <b>Adventure Series</b> doors utilizing Old World (<b>E.3</b>) profiles will be 3" [76mm] unless otherwise specified.</p> <p>Standard stile &amp; rail widths for <b>Adventure Series</b> doors utilizing Miter (<b>E.9</b>) profiles will be either 3" [76mm], 2 1/4" [57mm] or 1 1/2" [38mm] unless otherwise specified. Standard widths are determined by the profile number. If ordering stile &amp; rail widths at their standard sizes, please note the full <b>MP</b> profile number on the order form.</p> <ul style="list-style-type: none"> <li>• Example: <b>MP612-57 Stiles</b></li> <li>• Example: <b>MP643-76 Rails</b></li> </ul> <p>If you choose to deviate from the standard profile width, please include the first set of numbers of the <b>MP</b> profile (<b>MP643</b>) with the width dimension you prefer formatted after the hyphen (-).</p> <ul style="list-style-type: none"> <li>• Example: <b>MP643 - 2 3/4"</b></li> <li>• Example: <b>MP643 - 70mm</b></li> </ul> <p>Indicate any non-standard part sizes in the "Special Instructions" column on your order forms.</p> <p>All standard and non-standard part size rules apply. See <b>Section A.5</b> for more information.</p>
3	Adventure Series - Miter Profile Sizing	<p>Due to the manufacturing process, outside stiles and rails for <b>Adventure Series</b> doors utilizing miter profiles will finish at 1/16" [1.5mm] less in width than what is denoted by the stile and rail profile number.</p> <ul style="list-style-type: none"> <li>• For example, an <b>Adventure Series</b> door that is ordered with stile &amp; rail profile <b>MP643-76</b>, will have outside stiles and rails that finish at 2 1/16" [74.5mm] wide rather than 3" [76.0mm].             <ul style="list-style-type: none"> <li>◦ To result in a "true" 76mm wide stile &amp; rail width, the outside stile and rail sizes must be ordered at <b>77.50mm</b>, rather than 76mm.</li> </ul> </li> </ul> <p>The same would apply for outside stile and rail widths specified that deviate from the widths denoted by the profile number.</p> <ul style="list-style-type: none"> <li>• For example, if ordering an <b>Adventure Series</b> door with stile &amp; rail profile <b>MP643</b>, and you specify the outside stiles and rails to be 2 3/4" [70mm] wide, they will finish at 2 1/16" [68.5mm] wide rather than 2 3/4" [70.0mm].             <ul style="list-style-type: none"> <li>◦ To result in a "true" 70mm wide stile &amp; rail width, the outside stiles and rail sizes must be ordered at <b>71.50mm</b>, rather than 70.0mm.</li> </ul> </li> </ul> <p>Center stiles and center rails for <b>Adventure Series</b> construction will finish at specified dimensions.</p> <p>The maximum width for any stile or rail on an Adventure Series door using a miter profile is 9 1/16" [230.0mm], which will finish at 9" [228.5mm] as noted above.</p>

Adventure Series Raised & 1/4" Flat Panel Doors - END

► For PRICING ► See Section **B.7** in our current Wholesale Pricing Catalog.

No-Panel Cut (NPC) Frame Only Doors

WalzCraft offers the option to order a frame only door without the center panel cut. Sometimes used as a *wine cooler door*, this versatile product can be used anywhere that you need a frame door but don't need any type of center panel.

This is a cross-section of a Style 10 - "Frame Only" door with the SR107-NPC profile.

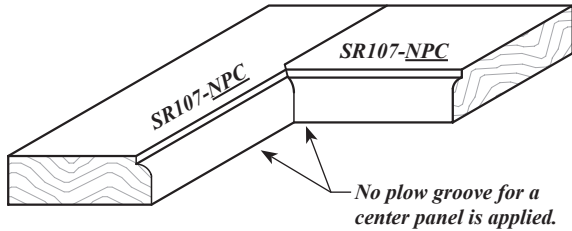

This is a cross-section of a Style 10 - "Frame Only" door with the SR100-NPC profile.

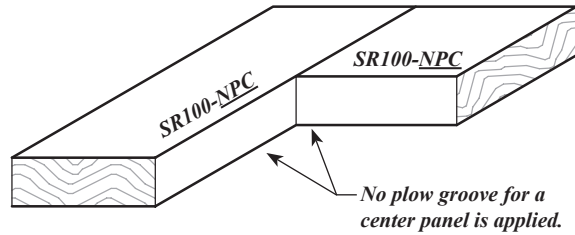

Style 10  
Frame Only Door

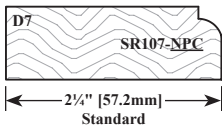
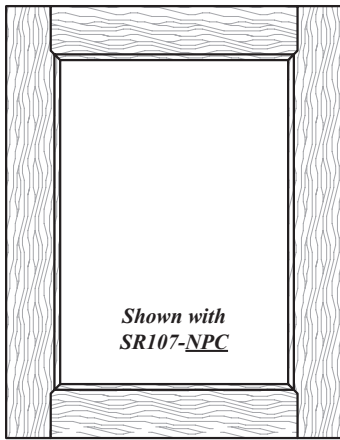

Style 10M  
Frame Only Door

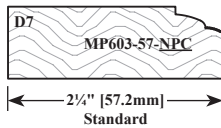
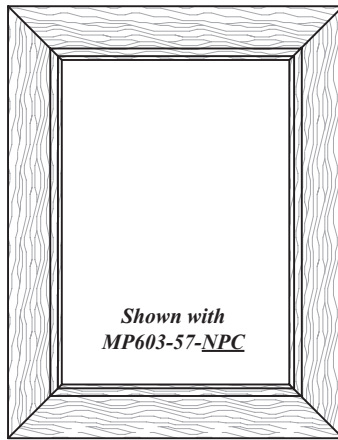

Style 10FM  
Frame Only Door

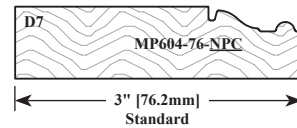
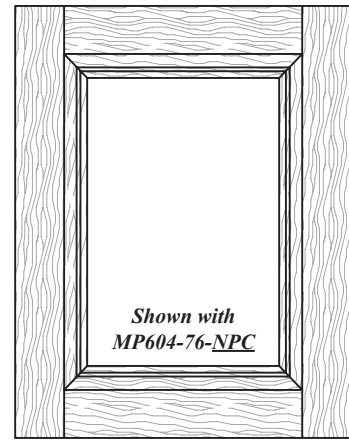

Not drawn at full scale.

No-Panel Cut (NPC) Frame Only Doors - Applied Moldings

WalzCraft offers alternative inside edge applied moldings for No-Panel Cut (NPC) Frame Only applications. The moldings are modified such that the bottom of the molding will be flush with the bottom of the stile or rail.

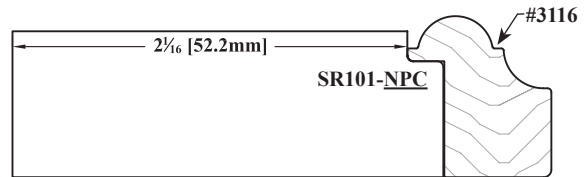
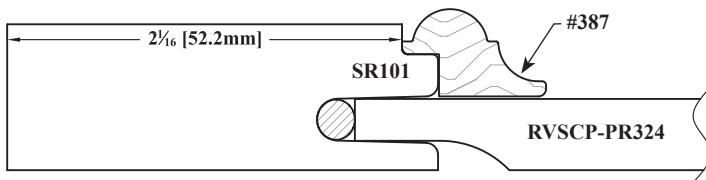

For a list of available No-Panel Cut (NPC) Inside Edge Applied Moldings, please see *Section N.5*.

Continued on next page...

► For PRICING ► See Section B.8 in our current Wholesale Pricing Catalog.

**Ordering & Pricing Notes: No-Panel Cut (NPC) Frame Only Doors**

**Ordering Guidelines**

1	Order Forms	Please use <i>Door Order Form (E•Z Form #2)</i> .
2	Required Information	Note “NPC” at the end when indicating your chosen Stile & Rail profile (ex: MP609-57-NPC) and check the “Frame Only” box when entering your quantities, door style and sizes.
<b>Pricing</b>		
1	Pricing	Please see <i>Section B.8</i> of our current <b>Wholesale Pricing Catalog</b> .

**Technical Notes: No-Panel Cut (NPC) Frame Only Doors**

**Cabinet Door & Drawer Front Options (Chapter B)**

1	Door Styles	Available as a Style 10 Frame Only, Style 10M Frame Only and Style 10FM Frame Only door.
---	-------------	--

**Functional Options (Chapter F)**

1	Hinge Boring	Hinge boring is available for No-Panel Cut Frame Only doors. Please see <i>Section F.1</i> for additional hinge boring requirements, ordering instructions and compatibility.
---	--------------	---

**General Information (Chapter A)**

1	Ready to Assemble (RTA)	RTA is available as an option.
---	-------------------------	--------------------------------

**Profile Options (Chapter E)**

1	Stile & Rail Profiles	<p><b>Style 10 Frame Only Doors:</b> Available with all Traditional and Old World stile &amp; rail profiles from <i>Sections E.1</i> and <i>E.3</i>. Stile and rail joints will be French Mitered unless utilizing square edged profiles.</p> <ul style="list-style-type: none"> <li>• Square edged profiles <b>SR100, SR104, SR123</b> and <b>SR195</b> will be Traditional joinery, as shown in the <b>SR100-NPC</b> drawing to the left.</li> </ul> <p><b>Style 10M Frame Only Doors:</b> Available with all <b>MP600/MP6000, MP700</b> and <b>MP900</b> Mitered Stile &amp; Rail profiles. All stile and rail joints will be fully mitered.</p> <p><b>Style 10FM Frame Only Doors:</b> Available with many of our <b>MP600/MP6000</b> Series Mitered Stile &amp; Rail profiles. Any <b>MP600/MP6000</b> series profile number that has a corresponding <b>[FM]</b> symbol is available for a French Miter door. All stile and rail joints will be French Mitered.</p>
2	Outside Edge Profiles	<p>Available with most outside edge profiles found in <i>Section E.15 &amp; E.16</i>.</p> <ul style="list-style-type: none"> <li>• Exceptions will apply where thicknesses are not compatible.</li> </ul> <p>Style 10FM doors not compatible with Molder Edge profiles.</p>
3	Applied Moldings	Modified Inside Edge Applied Moldings are available for <b>No-Panel Cut (NPC) Frame Only</b> doors. Please see <i>Section N.5</i> for available options. For a cross-reference guide detailing standard Applied Moldings and the corresponding NPC Applied Moldings, please reference the <i>NPC Applied Molding Cross-Reference Guide</i> on our website under: <b>Resources/Technical Information</b> .

**Sizes/Dimensions**

1	Thicknesses	<p>When using Traditional stile &amp; rail profiles, No-Panel Cut <b>Style 10</b> doors made from solid wood are available ¾" [19.3mm] and 1" [25.4mm] thick.</p> <p>When using Old World stile &amp; rail profiles, No-Panel Cut <b>Style 10</b> doors made from solid wood are available 1" [25.4mm], 1½" [28.6mm] and 1¼" [31.8mm] thick.</p> <p>When using Traditional mitered stile &amp; rail profiles, No-Panel Cut <b>Style 10M</b> doors made from solid wood are available ¾" [19.3mm] and 1" [25.4mm] thick.</p> <p>When using Old World mitered stile &amp; rail profiles, No-Panel Cut <b>Style 10M</b> doors made from solid wood are available 1" [25.4mm], 1½" [28.6mm] and 1¼" [31.8mm] thick.</p> <p>When using French Mitered stile and rail profiles, No-Panel Cut <b>Style 10FM</b> doors made from solid wood are available ¾" [19.3mm] and 1" [25.4mm] thick.</p> <p>See <i>Section S.3</i> for possible thickness restrictions based on wood species.</p>
2	Minimum & Maximum Sizes	<p>The maximum height for a door using French Miter construction is 96" [2438.4mm].</p> <p>The minimum length for a rail on a door using French Miter construction is 5½" [139.7mm].</p> <p>The maximum width for any stile and/or rail on a door using French Miter construction is 8<sup>3</sup>/<sub>32</sub>" [228.0mm].</p> <p>No-Panel Cut Frame Only doors with any of the following would require non-standard construction:</p> <ul style="list-style-type: none"> <li>• Doors greater than 96" [2438.4mm] high.</li> <li>• Rails less than 5½" [139.7mm] long.</li> <li>• Stiles and/or rails greater than 8<sup>3</sup>/<sub>32</sub>" [228.0mm] wide.</li> </ul> <p>Please submit these requests to our Customer Support Team. A quote will be provided, as additional charges may apply.</p>
3	Stile & Rail Widths	<b>No-Panel Cut (NPC) Frame Only</b> doors using French Miter construction will have the stiles & rails finish at the exact width specified. There will be <b>no</b> width reduction due to the French Miter manufacturing process.

**No Panel Cut Frame Only Doors - END**



Contemporary Slab & Batten Doors

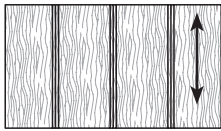

**Style: 1050\***  
**Drawer Front**  
 PC: 509  
 Frame: NA  
 Min. Size: 5x4½  
 [127mm x 111.1mm]

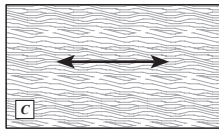

**Style: 1270\***  
**Drawer Front**  
 PC: 500  
 Frame: NA  
 Min. Size: 3x3  
 [76.2mm x 76.2mm]

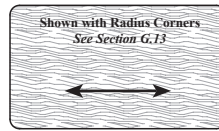

**Style: 1270\***  
**Drawer Front**  
 PC: 500  
 Frame: NA  
 Min. Size: 3x3  
 [76.2mm x 76.2mm]

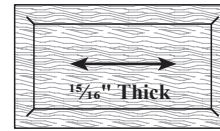

**Style: 1271\***  
**Drawer Front**  
 PC: 502  
 Frame: NA  
 Min. Size: See Notes

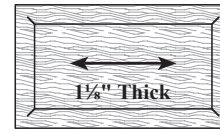

**Style: 1272\***  
**Drawer Front**  
 PC: 502  
 Frame: NA  
 Min. Size: See Notes

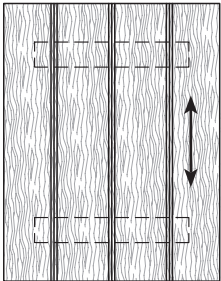

**Style: 1050**  
 PC: 510  
 Frame: NA  
 Min. Size: 6x4¾  
 [152.4mm x 111.1mm]  
 Use PC509 if ordering without battens.

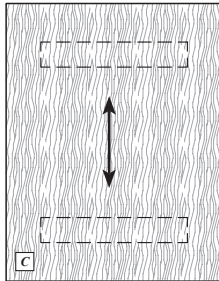

**Style: 1270**  
 PC: 501  
 Frame: NA  
 Min. Size: 6x4¾  
 [152.4mm x 111.1mm]  
 Use PC500 if ordering without battens.

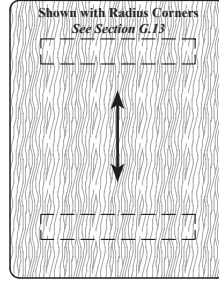

**Style: 1270**  
 PC: 501  
 Frame: NA  
 Min. Size: 6x4¾  
 [152.4mm x 111.1mm]  
 Use PC500 if ordering without battens.

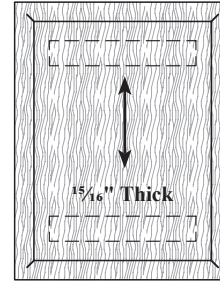

**Style: 1271**  
 PC: 503  
 Frame: NA  
 Min. Size: See Notes  
 Use PC502 if ordering without battens.

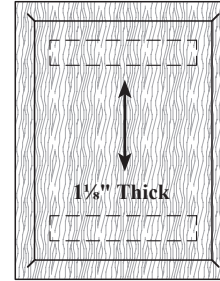

**Style: 1272**  
 PC: 503  
 Frame: NA  
 Min. Size: See Notes  
 Use PC502 if ordering without battens.

Style 1050 Cross Section

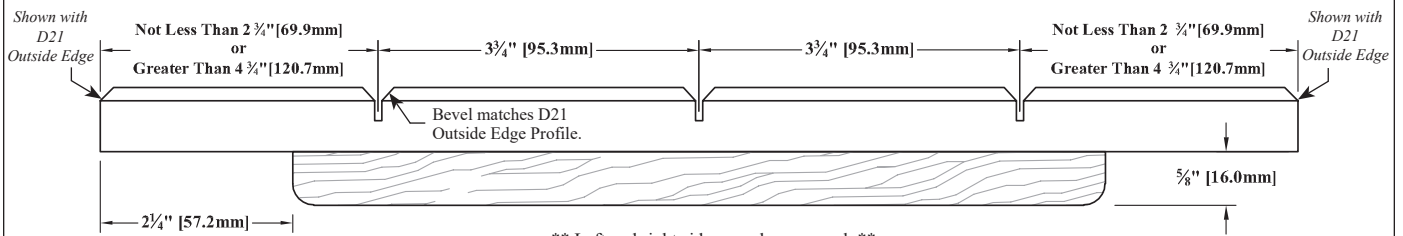

\*\* Left and right sides are always equal. \*\*

Ordering & Pricing Notes: Contemporary Slab & Batten Doors

Ordering Guidelines

1	Order Forms	Please use <i>Door and/or Drawer Front Order Forms (E-Z Forms #2 and #3)</i> .
---	-------------	--

Pricing

1	Pricing	Please see <i>Section B.9</i> of our current Wholesale Pricing Catalog.
---	---------	---

Technical Notes: Contemporary Slab & Batten Doors

Convex/Concave Options (Chapter D)

1	Curved Products	The  indicates door styles available as Curved Products; these are constructed with <b>NO Battens</b> . See <i>Chapter D</i> for ordering guidelines.
---	-----------------	--

Functional Options (Chapter F)

1	Hinge Boring	Hinge boring is available for Contemporary Slab & Batten doors. Please see <i>Section F.1</i> for additional hinge boring requirements, ordering instructions and compatibility.
---	--------------	--

Continued on next page...

► For PRICING ► See Section B.9 in our current Wholesale Pricing Catalog.

## Technical Notes: Contemporary Slab &amp; Batten Doors...continued

## General Information (Chapter A)

1	Grain Direction	Arrows (↔) indicate standard grain direction; grain direction may be specified at <b>NO</b> additional cost.
2	Warranty	Solid wood slab doors ordered without battens or with battens shipped unattached will carry no warranty against warpage. Please see <b>Section A.8 - Warranties</b> for more information on Glued Up Panel expansion/contraction, warping, bowing and twisting. • For sizes outside of warranty limitations, we recommend using our <b>Style 60</b> wood veneer doors with an <b>MDF</b> core (see <b>Section B.10 &amp; B.11</b> ).
3	Ready to Assemble (RTA)	RTA is not available as an option for Contemporary Slab & Batten doors.

## Hardware Options (Chapter I)

1	165° & 170° Hinges and Hinge Boring	Please note that our 165° long arm hinges, <b>Series 200</b> shown in <b>Section I.1</b> and the 170° long arm hinges shown in <b>Section I.7</b> , when used with the standard hinge bore placement shown in <b>Section F.1</b> , are <b>not compatible</b> with our standard batten placement shown on <b>page B.9.3</b> ( <i>custom batten placement may be an option</i> ).
---	-------------------------------------	---

## Material Options

1	Solid Wood	With this product being produced in solid wood, you could experience sunken glue joints or variances in thickness on the face of the staves due to expansion and contraction of the wood. This is more noticeable in darker stain colors and solid tone finishes and product finished with a water base finish. If this is a concern, we would recommend you order your door in raw <b>MDF</b> when applying a SolidTone, or order as a <b>Style 60/60*</b> ( <b>Section B.10 or B.11</b> ), which are <b>MDF</b> based, if ordering with a darker stain color.
---	------------	---

## Miscellaneous

1	Full Overlay or Inset Door Applications	<b>Styles 1050, 1270, 1271 and 1272</b> <b>are not</b> recommended for applications with tight tolerances due to concerns regarding expansion and contraction of overall width dimensions on vertical grain doors and height dimensions on horizontal grain doors.
2	Continuous Grain (End Matched Pattern)	Upon request, WalzCraft will manufacture hardwood components using a Continuous Grain - End Matched Pattern. This refers exclusively to the matching of grain in the direction of the grain. Available only with Contemporary Slab & Batten Doors and solid wood slab and RP drawer fronts. Additional custom engineering charges will apply. To inquire, please contact our Customer Support Team. Drawings and order details may be emailed to: <a href="mailto:customersupport@WalzCraft.com">customersupport@WalzCraft.com</a>
3	Battens	Dashed lines on drawings indicate the battens that are <b>attached to the back side</b> of the door. <b>Styles 1050, 1270, 1271 and 1272</b> can be ordered without battens. Indicate " <b>No Battens</b> " in the <i>Special Instructions</i> on your order form. <b>See warranty information above.</b> <b>Styles 1050, 1270, 1271 and 1272</b> can be ordered with battens shipped unattached. Indicate " <b>Ship Battens Unattached</b> " in the <i>Special Instructions</i> on your order form. <b>See warranty information above.</b> Battens will always run across the grain. • Battens are <b>not</b> glued to the doors, they are attached with screws. • Holes in the battens are drilled oversized to allow for expansion and contraction. • Battens that are requested to be shipped unattached, will have the holes drilled (in the battens only) and screws will be included. • <b>See warranty information above.</b>

## Profile Options (Chapter E)

1	Style 1270/1270*	<b>Style 1270</b> doors and <b>1270*</b> drawer fronts require the choice of an outside edge profile. Available with any outside edge profile from <b>Section E.15</b> .
2	Style 1271/1271*	<b>Style 1271</b> doors and <b>1271*</b> drawer fronts require the choice of an <b>RP</b> drawer front profile <b>and</b> an outside edge profile. Only available with the following <b>RP</b> (Raised Panel) drawer front profiles from <b>Section B.16</b> : • <b>318-25RP*, 319-10RP*, 320-32RP*, 321-32RP*, 328-32RP*, 329-19RP*</b> . As noted above, when applying an <b>RP</b> profile, you must also specify an outside edge profile • Available with all standard outside edge profiles from <b>Section E.15</b> <b>except</b> those noted as <b>3/4" Only</b> . • There is no additional charge for adding the outside edge.
3	Style 1272/1272*	<b>Style 1272</b> doors and <b>1272*</b> drawer fronts require the choice of an <b>RP</b> drawer front profile <b>and</b> an outside edge profile. Available with any <b>RP</b> (Raised Panel) drawer front profile from <b>Section B.16</b> with the <b>exception</b> of those listed for <b>Style 1271</b> above. As noted above, when applying an <b>RP</b> profile, you must also specify an outside edge profile • Available with all standard outside edge profiles from <b>Section E.15</b> <b>except</b> those noted as <b>3/4" Only</b> . • There is no additional charge for adding the outside edge.

Continued on next page...

► For PRICING ► See Section B.9 in our current Wholesale Pricing Catalog.

Technical Notes: Contemporary Slab & Batten Doors...continued

Sizes/Dimensions

<p><b>1</b> Minimum Sizes:</p> <ul style="list-style-type: none"> <li>• Style 1271/1271*</li> <li>• Style 1272/1272*</li> </ul>	<p>See <i>Section B.16</i> for minimum size calculation when applying an RP profile with an outside edge profile.</p>
<p><b>2</b> Thicknesses</p>	<p>Contemporary Slab &amp; Batten door and DF styles <b>1050, 1050*, 1270</b> and <b>1270*</b> made from solid wood are available <math>\frac{3}{4}</math>" [19.1mm] and 1" [25.4mm] thick.</p> <p><b>Style 1271/1271*</b> doors and drawer fronts finish at <math>\frac{15}{16}</math>" [23.8mm] thick.</p> <p><b>Style 1272/1272*</b> doors and drawer fronts finish at <math>1\frac{1}{8}</math>" [28.6mm] thick.</p> <p>See <i>Section S.3</i> for possible thickness restrictions based on wood species.</p>

Batten Placement (As seen from backside of door/drawer front)

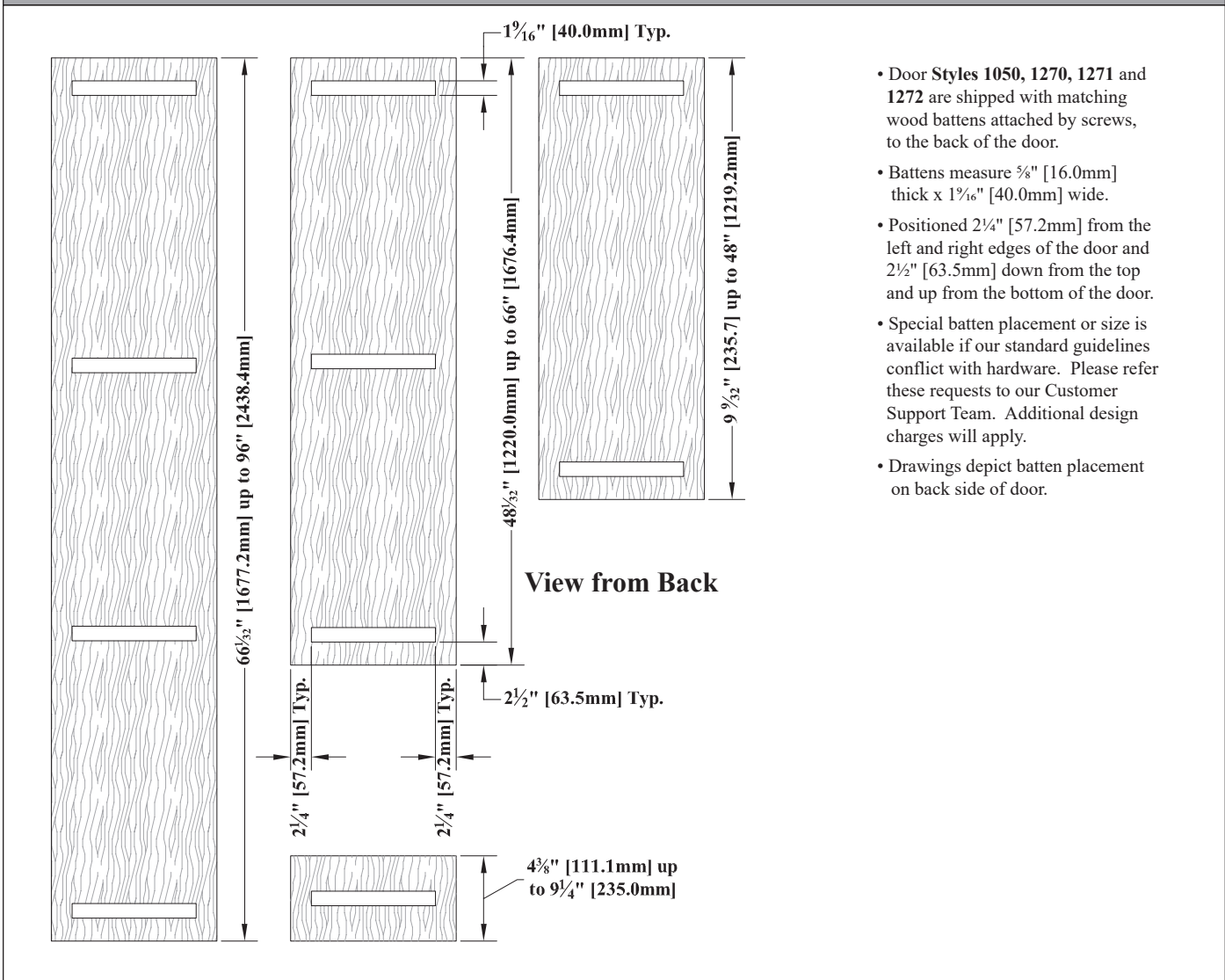

Contemporary Slab & Batten Doors and Drawer Fronts - END

► For PRICING ► See Section B.9 in our current Wholesale Pricing Catalog.

Contemporary Mortise & Tenon Doors

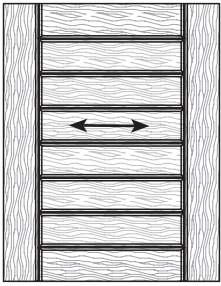

**Style: 1025**

PC: 505  
 Frame: PC101 x 0.6  
 Min. Size: 6x6  
 [152.4mm x 152.4mm]  
 Max. Height: 29<sup>5</sup>/<sub>16</sub>  
 [744.5mm]  
 (If over the max. height,  
 order as a Style 1125)

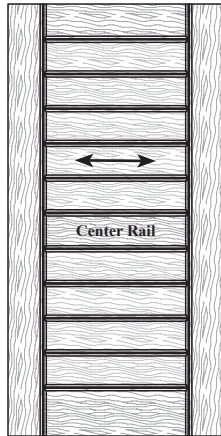

**Style: 1125**

PC: 507  
 Frame: PC103 x 0.6  
 Min. Size: 6x29<sup>5</sup>/<sub>16</sub>  
 [152.4mm x 746.1mm]  
 Max. Height: 54<sup>7</sup>/<sub>16</sub>  
 [1393.8mm]  
 (If over the max. height,  
 order as Style 2523)

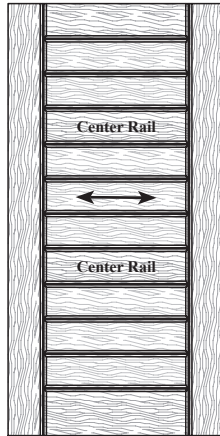

**Style: 2523**

PC: 511  
 Frame: PC108 x 0.6  
 Min. Size: 6x54<sup>5</sup>/<sub>16</sub>  
 [152.4mm x 1385.4mm]  
 Max. Height: 80<sup>7</sup>/<sub>16</sub>  
 [2043.1mm]

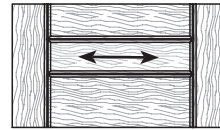

**Style: 1025\***  
 Drawer Front

PC: 505  
 Frame: PC101 x 0.6  
 Min. Size: 6x6  
 [152.4mm x 152.4mm]  
 Drawn at 8" [203.2mm] high

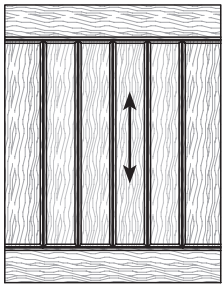

**Style: 2510**

PC: 504  
 Frame: PC101 x 0.6  
 Min. Size: 7x6  
 [177.8mm x 152.4mm]  
 Max. Width: 30<sup>3</sup>/<sub>16</sub>  
 [763.6mm]  
 (If over the max. width,  
 order as a Style 2515)

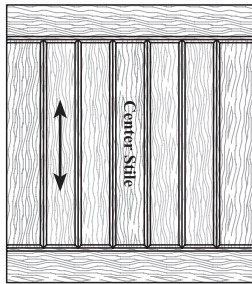

**Style: 2515**

PC: 508  
 Frame: PC103 x 0.6  
 Min. Size: 30<sup>3</sup>/<sub>16</sub>x15<sup>1</sup>/<sub>2</sub>  
 [765.2mm x 393.7mm]  
 Max. Width: 54<sup>7</sup>/<sub>16</sub>"  
 [1393.8mm]

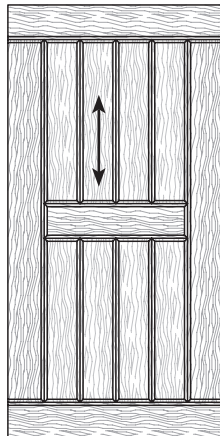

**Style: 2511**

PC: 506  
 Frame: PC103 x 0.6  
 Min. Size: 7x11<sup>1</sup>/<sub>4</sub>  
 [177.8mm x 285.8mm]

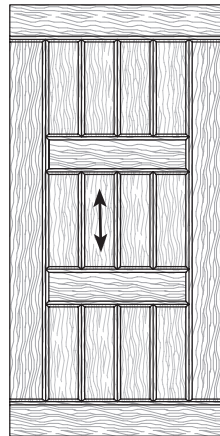

**Style: 2522**

PC: 512  
 Frame: PC108 x 0.6  
 Min. Size: 7x15<sup>1</sup>/<sub>4</sub>  
 [177.8mm x 400.1mm]

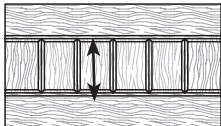

**Style: 2510\***  
 Drawer Front

PC: 504  
 Frame: PC101 x 0.6  
 Min. Size: 7x6  
 [177.8mm x 152.4mm]  
 Max. Width: 30<sup>3</sup>/<sub>16</sub>  
 [763.6mm]  
 (If over the max. width,  
 order as a Style 2515\*)

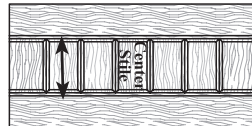

**Style: 2515\***  
 Drawer Front

PC: 508  
 Frame: PC103 x 0.6  
 Min. Size: 30<sup>3</sup>/<sub>16</sub>x6<sup>5</sup>/<sub>16</sub>  
 [765.2mm x 152.4mm]  
 Max. Width: 54<sup>7</sup>/<sub>16</sub>"  
 [1393.8mm]

► For PRICING ► See Section B.9 in our current Wholesale Pricing Catalog.

Style 1025 Contemporary Mortise & Tenon

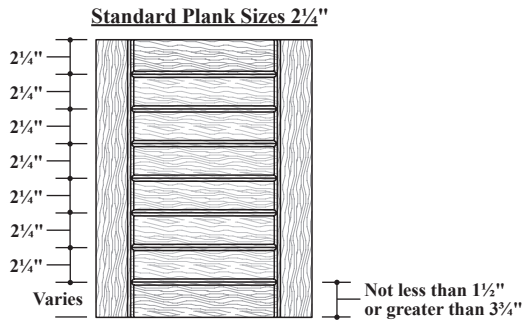

Style 2510 Contemporary Mortise & Tenon

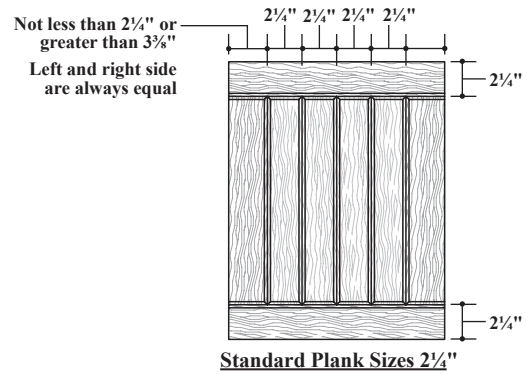

Style 1025 with D21, SR116 (Mirror Joint), PR314-06

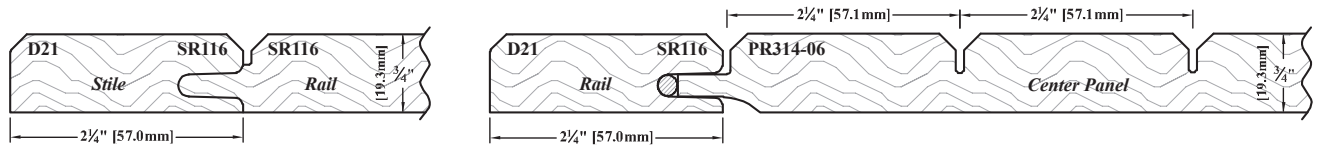

Not drawn at full scale.

Style 1025 with D33, SR149 (Mirror Joint), PR339-04

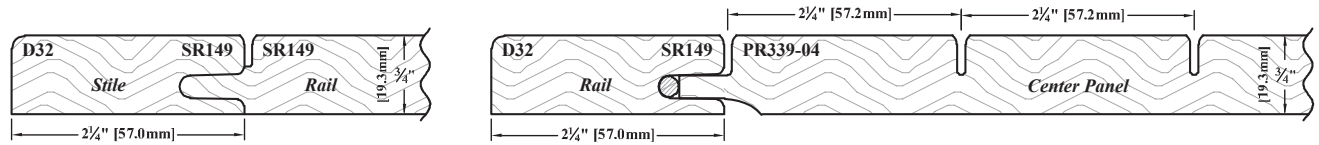

Not drawn at full scale.

Continued on next page...

► For PRICING ► See Section **B.9** in our current Wholesale Pricing Catalog.

**Ordering & Pricing Notes: Contemporary Mortise & Tenon Doors**

**Ordering Guidelines**

1	Order Forms	Please use <i>Door and/or Drawer Front Order Forms (E-Z Forms #2 and #3)</i> .
<b>Pricing</b>		
1	Pricing	Please see <i>Section B.9</i> of our current <b>Wholesale Pricing Catalog</b> .

**Technical Notes: Contemporary Mortise & Tenon Doors**

**Cabinet Door & Drawer Front Options (Chapter B)**

1	Mortise & Tenon	Allows for center panel expansion and contraction.
---	-----------------	--

**General Information (Chapter A)**

1	Grain Direction	Arrows (←→) shown indicate standard grain direction. Grain direction may not be specified.
2	Ready to Assemble (RTA)	RTA is available as an option for Contemporary Mortise & Tenon doors.

**Functional Options (Chapter F)**

1	Hinge Boring	Hinge boring is available for Contemporary Mortise & Tenon doors. Please see <i>Section F.1</i> for additional hinge boring requirements, ordering instructions and compatibility. For <b>Styles 2510, 2511, 2515 and 2522</b> , please check hinge bore placement compatibility when increasing the width of top and bottom rails.
---	--------------	--

**Profile Options (Chapter E)**

1	Design Style	Contemporary Mortise & Tenon doors utilize an outside edge profile ( <i>Section E.15</i> ), a mirror stile & rail joint ( <i>Section E.2</i> ), a center panel profile ( <i>Section E.12</i> ), and grooves on the center panel that all match one another, creating the plank door look. <ul style="list-style-type: none"> <li>The center panel is one solid piece, not individual planks (see drawings on previous page).</li> </ul>
2	Profile Combinations	The <b>SR116</b> mirror joint is paired with center panel profile <b>PR314-06</b> and outside edge profile <b>D21</b> . <ul style="list-style-type: none"> <li>Grooves are added to the center panel that mimic our center panel face rout pattern CPFR2400.</li> </ul> The <b>SR149</b> mirror joint is paired with center panel profile <b>PR339-04</b> and outside edge profile <b>D32</b> or <b>D51</b> . <ul style="list-style-type: none"> <li>Grooves are added to the center panel that mimic our center panel face rout pattern CPFR2500.</li> </ul>

**Sizes/Dimensions**

1	Styles 1025, 1125, 2523 (See above illustrations)	Bottom Rail dimension will vary depending on the height; the remaining stiles and rails will be 2¼" [57.2mm] wide. When ordering stile & rail sizes other than 2¼" [57.2mm] wide, plank sizes may be compromised requiring custom configuration. Additional charges may apply to customize configuration. Frame only doors will have all stiles and rails at 2¼" [57.2mm] wide unless otherwise noted.
2	Styles 2510, 2511, 2515, 2522 (See above illustrations)	Left and right stile dimensions will vary depending on the overall width of door. The top and bottom rails will be 2¼" [57.2mm] wide. When ordering stile sizes <i>other than noted in the illustration above</i> , plank sizes may be compromised requiring custom configuration. Additional charges may apply to customize configuration. Frame only doors will have all stiles and rails at 2¼" [57.2mm] wide unless other noted.
3	Non-Standard Parts	If you plan to align Contemporary Mortise & Tenon doors with other, "Frame Only" Contemporary Mortise & Tenon doors, part sizes could vary due to required opening sizes. WalzCraft does not automatically modify the width of the stiles/rails to compensate for this.
4	Thicknesses	Contemporary mortise & tenon raised panel doors and drawer fronts are available ¾" [19.1mm] and 1" [25.4mm] thick. See <i>Section S.3</i> for possible thickness restrictions based on wood species.

**Contemporary Mortise & Tenon Doors - END**

► For PRICING ► See *Section B.9* in our current Wholesale Pricing Catalog.



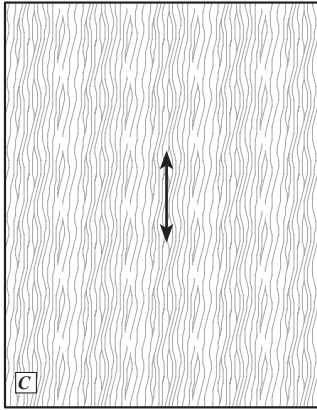

Style: 60  
PC: Determined by chosen EBT Option

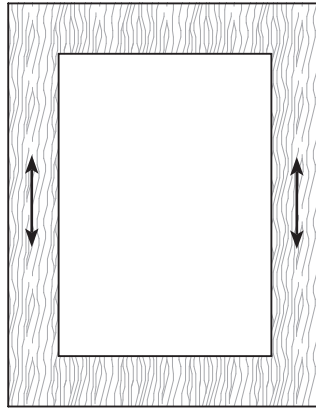

Style: 60 Frame Only  
PC: Determined by chosen EBT Option

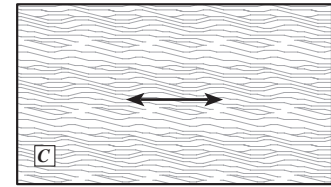

Style: 60\* Drawer Front  
PC: Determined by chosen EBT Option

EBT201 Family (Wood Veneer Edge - Machine Applied)

EBT201

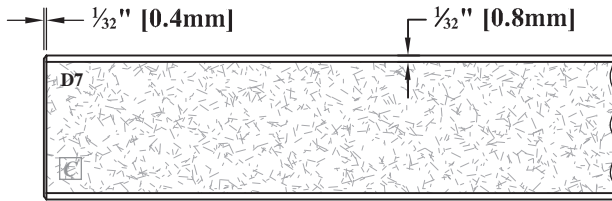

- Only available with D7 Outside Edge Profile.

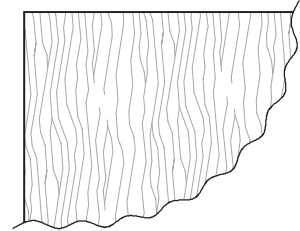

Minimum Size: 3" x 3" [76.2mm x 76.2mm] after edgebanding.

EBT201 - Frame Only

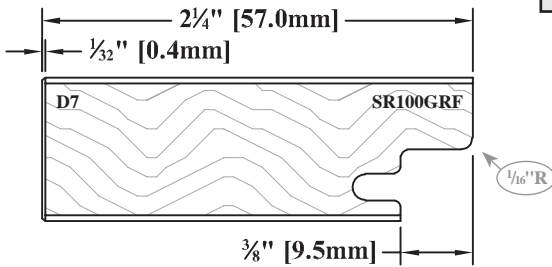

- Only available with D7 Outside Edge Profile.
- Only available with SR100GRF S/R Profile.

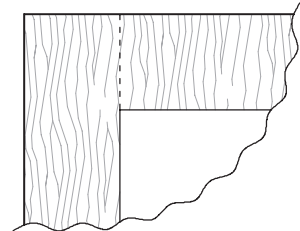

Minimum Size: 6 3/8" x 6" [168.3mm x 152.4mm] after edgebanding.

EBT201 - Frame Only - NPC (No-Panel Cut)

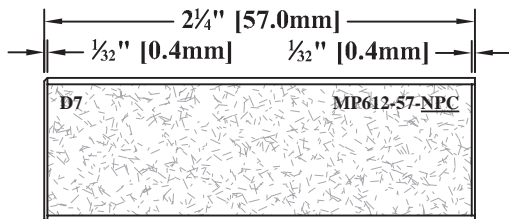

- Only available with D7 Outside Edge Profile.
- Only available with MP612-57-NPC or MP612-76-NPC Stile/Rail Profile.

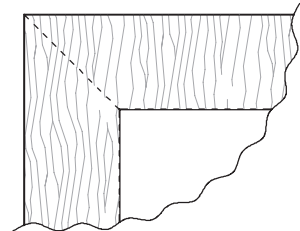

Minimum Size: 6" x 6" [152.4mm x 152.4mm] after edgebanding.

Continued on next page...

► For PRICING ► See Section **B.10** in our current Wholesale Pricing Catalog.

EBT202 Family ( $\frac{1}{8}$ " [3.2mm] Solid Wood Edge - Machine Applied)

EBT202

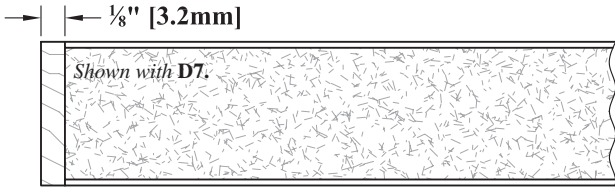

- Only available with **D7, D33, D66, D147** Outside Edge Profile.

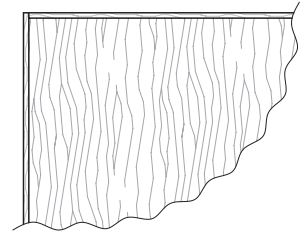

Minimum Size:  $3\frac{1}{4}$ " x  $3\frac{1}{4}$ " [82.6mm x 82.6mm] after edgebanding.

EBT202 - Frame Only

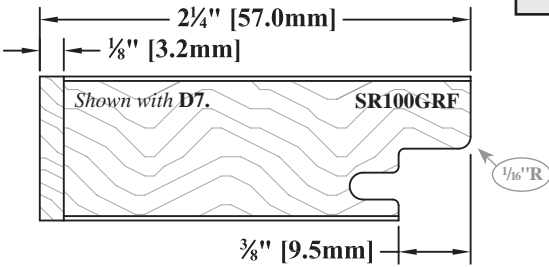

- Only available with **D7, D33, D66, D147** Outside Edge Profile.
- Only available with **SR100GRF S/R** Profile.

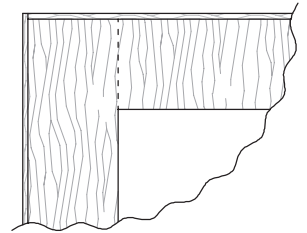

Minimum Size:  $6\frac{1}{8}$ " x 6" [168.3mm x 152.4mm] after edgebanding.

EBT202 - Frame Only - NPC  
(No-Panel Cut)

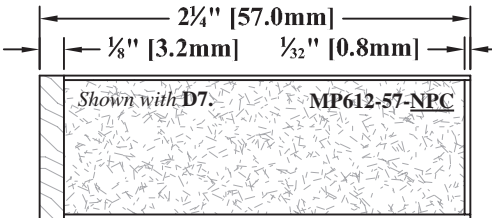

- Only available with **D7, D33, D66, D147** Outside Edge Profile.
- Only available with **MP612-57-NPC** or **MP612-76-NPC** Stile/Rail Profile.

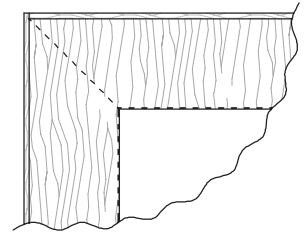

Minimum Size: 6" x 6" [152.4mm x 152.4mm] after edgebanding.

Continued on next page...

► For PRICING ► See Section **B.10** in our current Wholesale Pricing Catalog.

EBT501 Family (Solid Wood Edge - Hand Applied)

EBT501

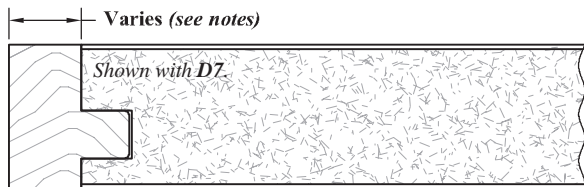

- Not all Outside Edge Profiles are available.
- Width of solid wood edge will vary based on chosen Outside Edge Profile.

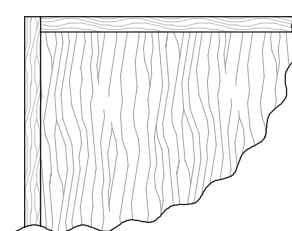

Minimum Size: Varies based on chosen Outside Edge Profile. See Notes for more information.

EBT501 - Frame Only

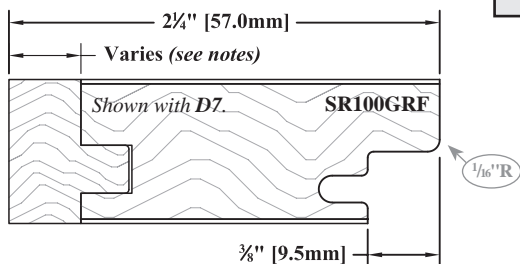

- Not all Outside Edge Profiles are available.
- Width of solid wood edge will vary based on chosen Outside Edge Profile.
- Only available with **SR100GRF** S/R Profile.

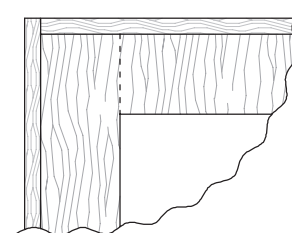

Minimum Size: Varies based on chosen Outside Edge Profile. See Notes for more information.

EBT501 - Frame Only - NPC (No-Panel Cut)

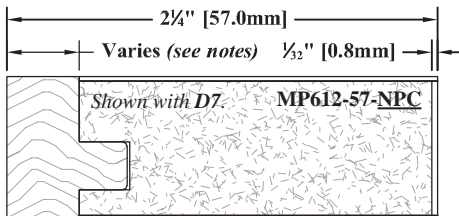

- Not all Outside Edge Profiles are available.
- Width of solid wood edge will vary based on chosen Outside Edge Profile.
- Only available with **MP612-57-NPC** or **MP612-76-NPC** S/R Profile.

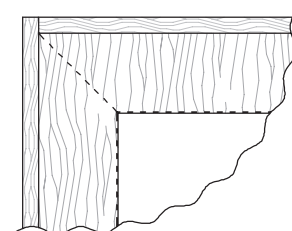

Minimum Size: Varies based on chosen Outside Edge Profile. See Notes for more information.

Continued on next page...

► For PRICING ► See Section **B.10** in our current Wholesale Pricing Catalog.

EBT601 Family (Solid Wood Edge - Hand Applied)

EBT601

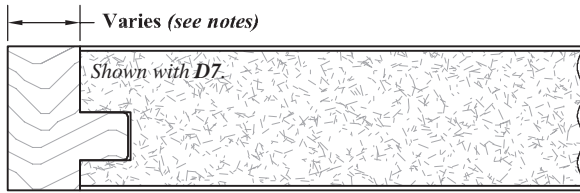

- Not all Outside Edge Profiles are available.
- Width of solid wood edge will vary based on chosen Outside Edge Profile.

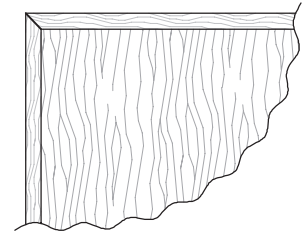

Minimum Size: Varies based on chosen Outside Edge Profile. See Notes for more information.

EBT601 - Frame Only

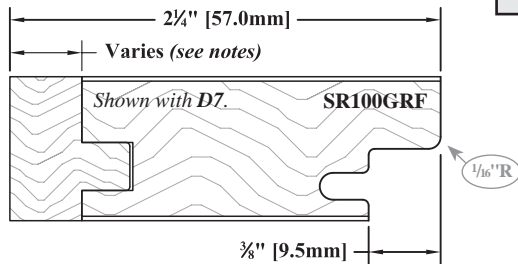

- Not all Outside Edge Profiles are available.
- Width of solid wood edge will vary based on chosen Outside Edge Profile.
- Only available with **SR100GRF** S/R Profile.

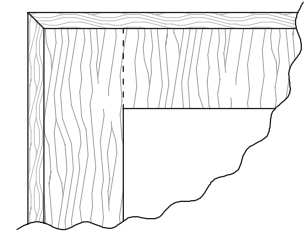

Minimum Size: Varies based on chosen Outside Edge Profile. See Notes for more information.

EBT601 - Frame Only - NPC (No-Panel Cut)

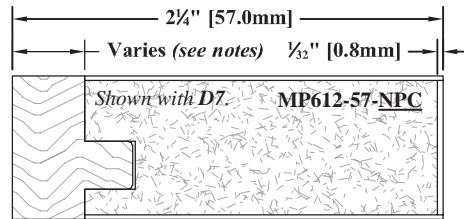

- Not all Outside Edge Profiles are available.
- Width of solid wood edge will vary based on chosen Outside Edge Profile.
- Only available with **MP612-57-NPC** or **MP612-76-NPC** Stile/Rail Profile.

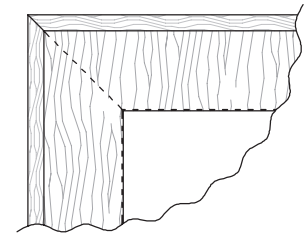

Minimum Size: Varies based on chosen Outside Edge Profile. See Notes for more information.

Continued on next page...

► For PRICING ► See Section [B.10](#) in our current Wholesale Pricing Catalog.

EBT701 Family (Solid Wood Edge - Hand Applied)

EBT701

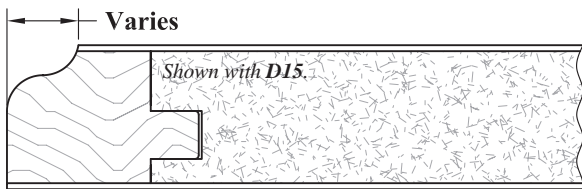

- Not all Outside Edge Profiles are available.
- Width of solid wood edge will vary based on chosen Outside Edge Profile.

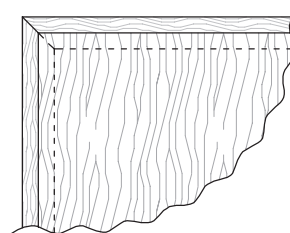

Minimum Size: Varies based on chosen Outside Edge Profile. See Notes for more information.

EBT701 - Frame Only

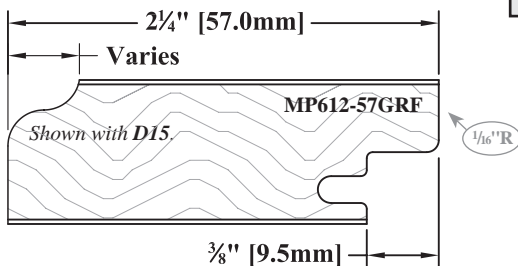

- Not all Outside Edge Profiles are available.
- Only available with **MP612-57GRF** or **MP612-76GRF** Stile/Rail Profile.

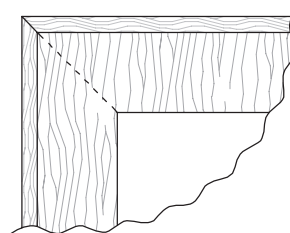

Minimum Size: 6" x 6" [152.4mm x 152.4mm] after edgedbanding.

EBT701 - Frame Only - NPC (No-Panel Cut)

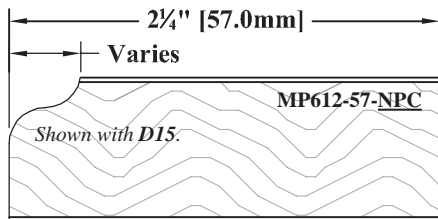

- Not all Outside Edge Profiles are available.
- Only available with **MP612-57-NPC** or **MP612-76-NPC** Stile/Rail Profile.

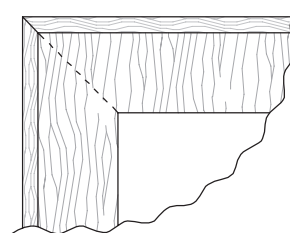

Minimum Size: 6" x 6" [152.4mm x 152.4mm] after edgedbanding.

Continued on next page...

► For PRICING ► See Section **B.10** in our current Wholesale Pricing Catalog.

EBT100 (Raw Edge)



- Only available with Applied Molding Outside Edge profiles for 1/16" thick Veneered & Edgedbanded doors.

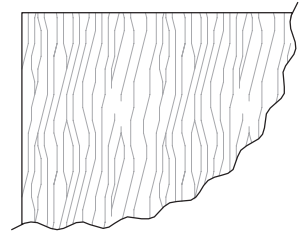

Minimum Size: 3" x 3" [76.2mm x 76.2mm]

See following pages for available Applied Molding Outside Edge Profiles.

EBT101 (Raw Edge)

EBT101

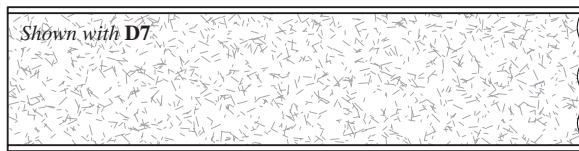

- Available with a D7 Outside Edge Profile or available with Applied Molding Outside Edge profiles for 3/4" thick or 1" thick Veneered & Edgedbanded doors.

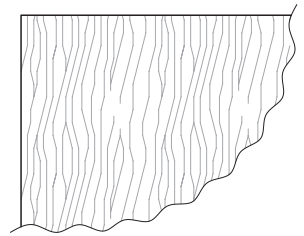

Minimum Size: 3" x 3" [76.2mm x 76.2mm]

EBT101 - Frame Only

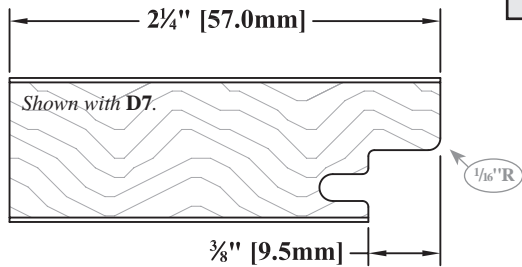

- Available with a D7 Outside Edge Profile or available with Applied Molding Outside Edge profiles for 3/4" thick or 1" thick Veneered & Edgedbanded doors.
- Only available with SR100GRF S/R Profile.

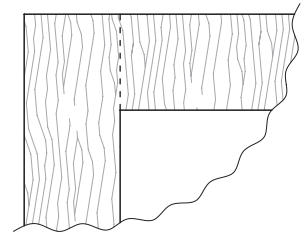

Minimum Size: 6 3/8" x 6" [168.3mm x 152.4mm] after edgebanding.

EBT101 - Frame Only - NPC (No-Panel Cut)

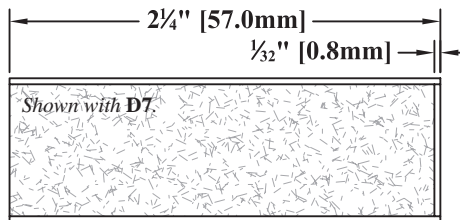

- Available with a D7 Outside Edge Profile or available with Applied Molding Outside Edge profiles for 3/4" thick or 1" thick Veneered & Edgedbanded doors.
- Only available with MP612-57-NPC or MP612-76-NPC Stile/Rail Profile.

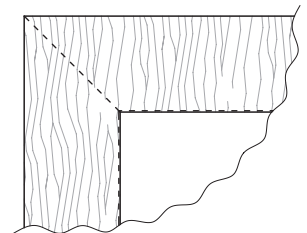

Minimum Size: 6" x 6" [152.4mm x 152.4mm] after edgebanding.

See following pages for available Applied Molding Outside Edge Profiles.

Continued on next page...

▶ For PRICING ▶ See Section [B.10](#) in our current Wholesale Pricing Catalog.

Applied Molding Outside Edges for 1/16" Thick Veneered & Edgedbanded Doors with EBT100

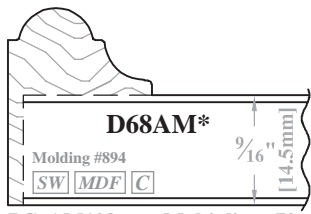

**D68AM\***  
Molding #894  
SW MDF C  
PC: AM103 Multiplier: .70  
No Hinge Boring Available

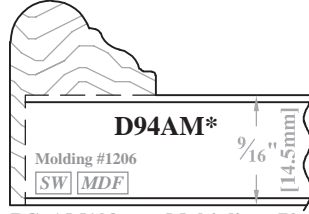

**D94AM\***  
Molding #1206  
SW MDF  
PC: AM103 Multiplier: .70  
No Hinge Boring Available

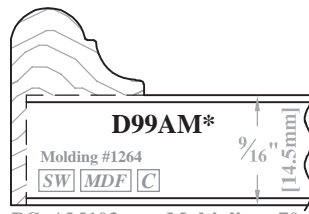

**D99AM\***  
Molding #1264  
SW MDF C  
PC: AM103 Multiplier: .70  
No Hinge Boring Available

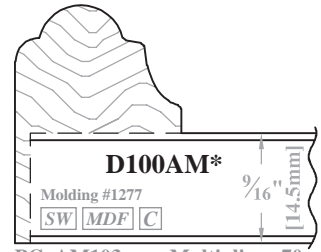

**D100AM\***  
Molding #1277  
SW MDF C  
PC: AM103 Multiplier: .70  
No Hinge Boring Available



**D111AM\***  
Molding #1328  
SW MDF  
PC: AM103 Multiplier: .70  
No Hinge Boring Available



**D113AM\***  
Molding #1337  
SW MDF  
PC: AM103 Multiplier: .70  
No Hinge Boring Available

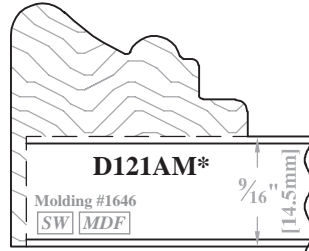

**D121AM\***  
Molding #1646  
SW MDF  
PC: AM103 Multiplier: .82  
No Hinge Boring Available

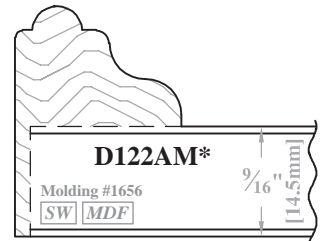

**D122AM\***  
Molding #1656  
SW MDF  
PC: AM103 Multiplier: .70  
No Hinge Boring Available



**D136AM\***  
Molding #847  
SW MDF C  
PC: AM103 Multiplier: .70  
No Hinge Boring Available



**D142AM\***  
Molding #1891  
SW MDF  
PC: AM101 Multiplier: .70  
No Hinge Boring Available

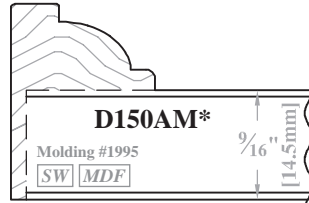

**D150AM\***  
Molding #1995  
SW MDF  
PC: AM103 Multiplier: .70  
No Hinge Boring Available



**D171AM\***  
Molding #852  
SW MDF C  
PC: AM101 Multiplier: .70  
No Hinge Boring Available

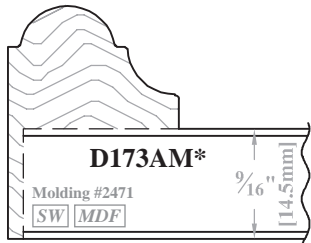

**D173AM\***  
Molding #2471  
SW MDF  
PC: AM103 Multiplier: .80  
No Hinge Boring Available

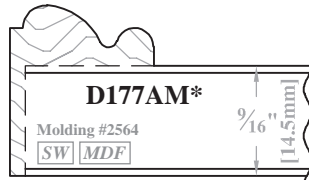

**D177AM\***  
Molding #2564  
SW MDF  
PC: AM101 Multiplier: .70  
No Hinge Boring Available

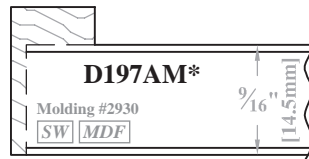

**D197AM\***  
Molding #2930  
SW MDF  
PC: AM101 Multiplier: .70  
No Hinge Boring Available

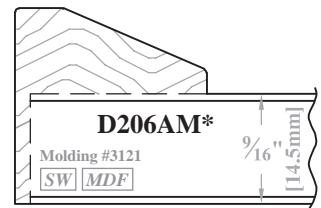

**D206AM\***  
Molding #3121  
SW MDF  
PC: AM103 Multiplier: .70  
No Hinge Boring Available

Continued on next page...

► For PRICING ► See Section **B.10** in our current Wholesale Pricing Catalog.

Applied Molding Outside Edges for 3/4" Thick Veneered & Edgembanded Doors with EBT101 Family

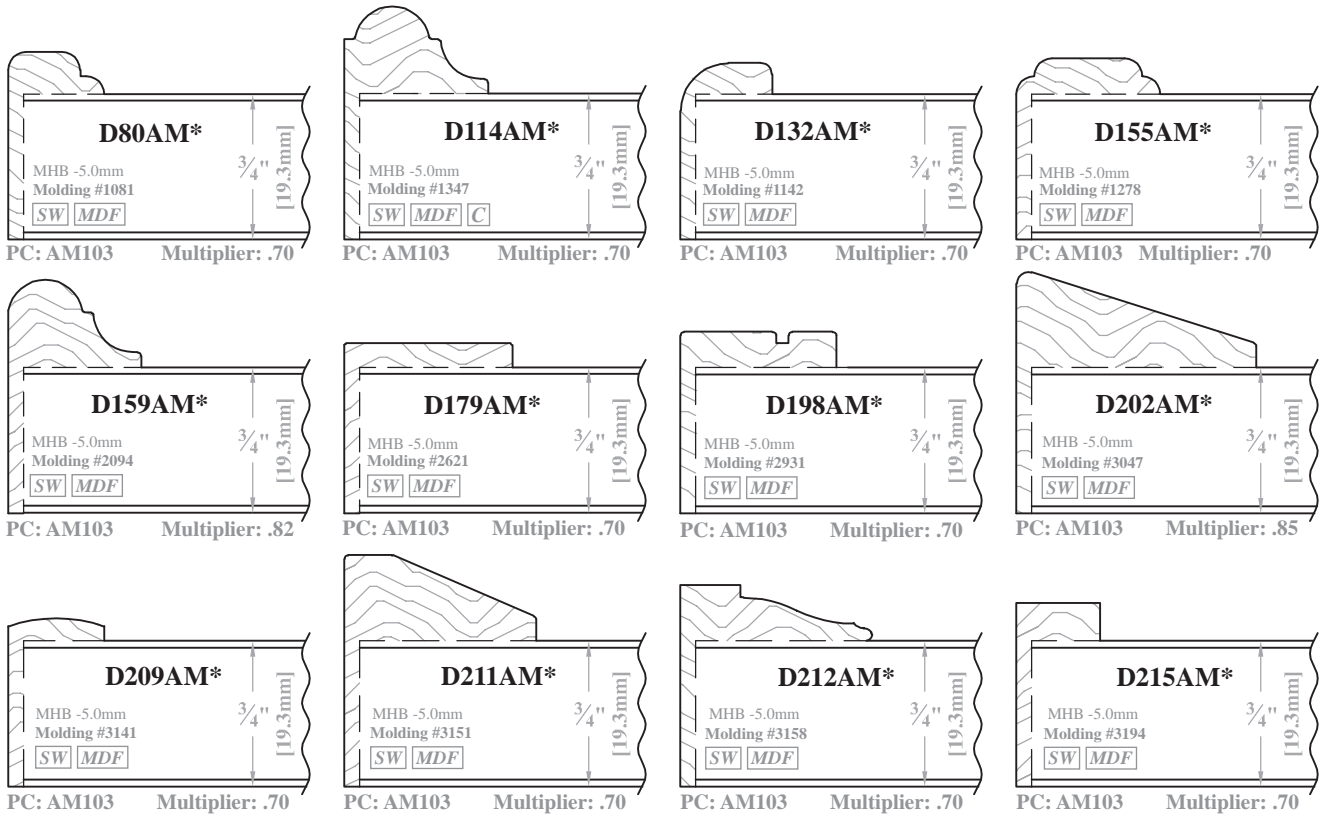

Applied Molding Outside Edges for 1" Thick Veneered & Edgembanded Doors with EBT101 Family

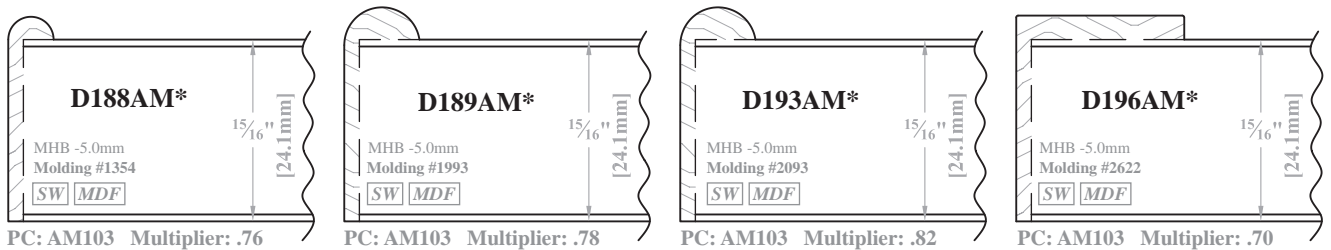

Continued on next page...

► For PRICING ► See Section [B.10](#) in our current Wholesale Pricing Catalog.

EBT102 (Wood Veneer Edge - Machine Applied)

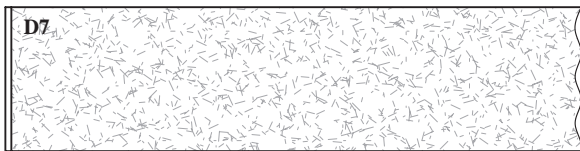

- Raw MDF or MDF-MR, with veneer edgebanding on 4 edges.
- Only available with **D7** Outside Edge Profile.

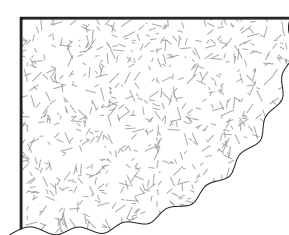

This edgebanding option is recommended when a SolidTone® finish will be applied on raw MDF/MDF-MR doors and drawer fronts with a **D7** outside edge profile. Minimum Size: 3" x 3" [76.2mm x 76.2mm].

EBT103 (1/8" [3.2mm] Solid Wood Edge - Machine Applied)



- Raw MDF or MDF-MR, with 1/8" solid wood edgebanding on 4 edges.
- Only available with **D7, D33, D66, D147** Outside Edge Profiles.



This edgebanding option is recommended when a SolidTone® finish will be applied on MDF or MDF-MR doors and drawer fronts with a **D7** outside edge profile. Minimum Size: 3 1/4" x 3 1/4" [82.6mm x 82.6mm] after edgebanding.

Continued on next page...

► For PRICING ► See Section **B.10** in our current Wholesale Pricing Catalog.

**Solid Wood Egebanding Visible from Face of Door: EBT202, EBT501, EBT601**

Face Veneer Grain/Cut	Edgeband Grain/Cut from Face	Edgeband Grain/Cut from Edge
Plain Sliced (PS) Veneer	Plain Sawn (PS) Solid Wood	Quarter Sawn (QS) Solid Wood
Rotary Cut (RC) Veneer	Plain Sawn (PS) Solid Wood	Quarter Sawn (QS) Solid Wood
Quarter Sawn (QS) Veneer	Quarter Sawn (QS) Solid Wood	Plain Sawn (PS) Solid Wood
Straight Grain (SG) Veneer	Straight Grain (SG) Solid Wood	Plain Sawn (PS) Solid Wood

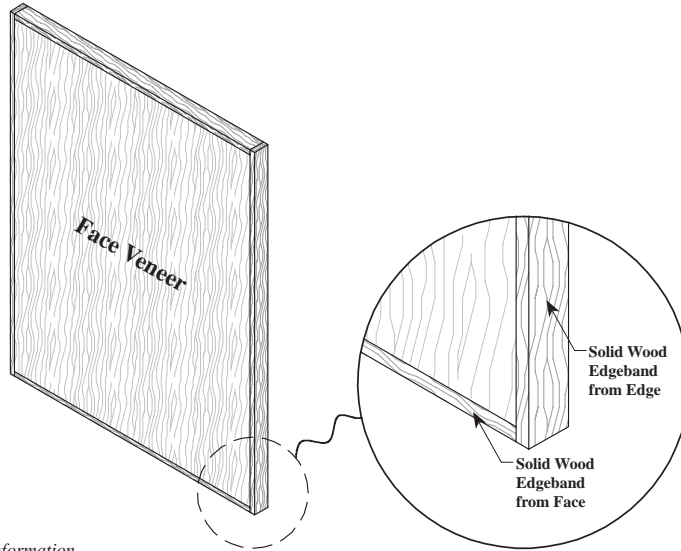

\*See Wood Species Options note for more information.

**Solid Wood Egebanding Not Visible from Face of Door: EBT701**

Face Veneer Grain/Cut	Edgeband Grain/Cut from Face	Edgeband Grain/Cut from Edge
Plain Sliced (PS) Veneer	N/A	Quarter Sawn (QS) Solid Wood
Rotary Cut (RC) Veneer	N/A	Quarter Sawn (QS) Solid Wood
Quarter Sawn (QS) Veneer	N/A	Plain Sawn (PS) Solid Wood
Straight Grain (SG) Veneer	N/A	Plain Sawn (PS) Solid Wood

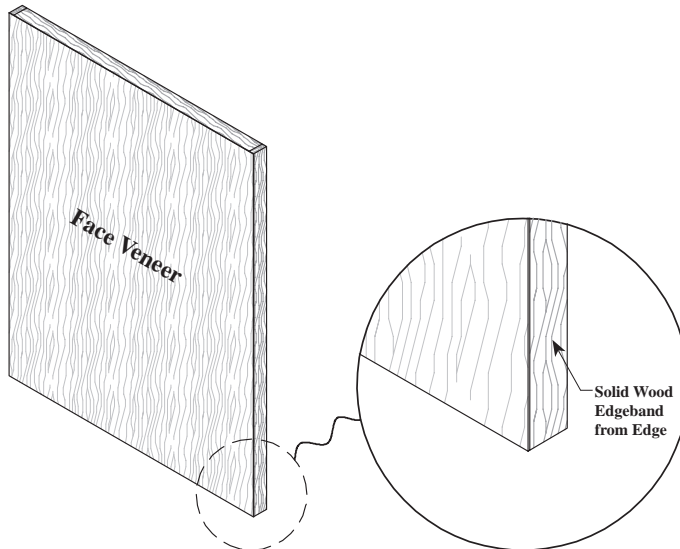

\*See Wood Species Options note for more information.

Continued on next page...

► For PRICING ► See Section **B.10** in our current Wholesale Pricing Catalog.

## Ordering &amp; Pricing Notes: Style 60 Veneered &amp; Edgedbanded Doors &amp; Drawer Fronts

## Ordering Guidelines

1	Order Forms	Please use <i>Veneered &amp; Edgedbanded Door and Drawer Front Order Form (E•Z Form #7)</i> .
<b>Pricing</b>		
1	Pricing	Please see <i>Section B.10</i> of our current <b>Wholesale Pricing Catalog</b> .

## Technical Notes: Style 60 Veneered &amp; Edgedbanded Doors &amp; Drawer Fronts

## Cabinet Door &amp; Drawer Front Options (Chapter B)

1	Frame Only Doors	Not available with mullion lite patterns.
		Not available with center stiles or rails.
		GRF cut is designed to accept our rubber glass retainer. See <i>Section B.12</i> for more information.

## Convex/Concave Options (Chapter D)

1	Available Products	The <input type="checkbox"/> indicates that this product is available convex/concave. <ul style="list-style-type: none"> <li>• <b>EBT201</b> is the only edgeband treatment option available.</li> <li>• Frame only doors not available convex/concave.</li> </ul>
2	Edgebanding	In the case of convex/concave doors and drawer fronts, the edgebanding will be hand applied.
		Lineal grain direction on the top and bottom edge of a convex/concave door will run in a straight line. <ul style="list-style-type: none"> <li>• The grain will not follow the radius.</li> </ul>

## Dealer Aid Options (Chapter T)

1	Finished Color Blocks	See <i>Dealer Aid Section T.1</i> for finished color samples.
---	-----------------------	---

## Design Options (Chapter G)

1	Grain and Color Coordination	Grain and Color Coordination is an option for veneer doors. <ul style="list-style-type: none"> <li>• WalzCraft only offers this option in conjunction with <b>EBT201</b>.</li> <li>• <b>EBT201 Frame Only</b> doors are <u>not</u> available with Grain and Color Coordination.</li> <li>• Please see <i>Section G.17</i> for more information.</li> </ul>
---	------------------------------	--

## Finish Options (Chapter R)

1	Rub Through	<b>EBT701</b> is the only option that allows Rub Through. <ul style="list-style-type: none"> <li>• Please see <i>Section R.4</i> for more information on our Rub Through options.</li> </ul>
2	SolidTone®	Certain Edgeband Treatment options are recommended when a SolidTone® finish will be applied on <b>MDF</b> or <b>MDF-MR</b> doors and drawer fronts with a <b>D7</b> outside edge profile. <ul style="list-style-type: none"> <li>• See <b>EBT102</b> and <b>EBT103</b> notes.</li> </ul>

## Functional Options (Chapter F)

1	Finger Pull Routs FP100 & FP200	Only available with the <b>EBT101</b> and <b>EBT701</b> . <ul style="list-style-type: none"> <li>• When using the <b>EBT701</b>, the edgeband width must be at least ½" [12.7mm].</li> </ul>
2	Hinge Boring	Hinge boring is available for Style 60 Veneered & Edgedbanded doors & drawer fronts. <ul style="list-style-type: none"> <li>• Please see <i>Section F.1</i> for additional hinge boring requirements, ordering instructions and compatibility.</li> </ul>
3	Finger Pull Moldings	Finger Pull Moldings <i>can only be used</i> with <b>EBT</b> options if using a <b>D7</b> outside edge profile.
		Not all <b>EBT</b> options are compatible. Please see the <b>EBT - Fingerpull Molding Compatibility</b> chart on our website: <b>Resources &gt; Technical Information &gt; Compatibility Charts</b> .

## General Information (Chapter A)

1	Grain Direction	Arrows(←→) throughout the catalog indicate standard grain direction. <ul style="list-style-type: none"> <li>• Grain direction may be specified at <b>NO additional cost</b> (includes frame only door).</li> </ul>
2	Horizontal Grain	If your project is being ordered with Horizontal grain and there are multiple doors and/or drawer fronts adjacent to each other, WalzCraft strongly suggests that you consider using our Grain and Color Coordination option. Please supply WalzCraft with a drawing or sketch of how the doors and drawer fronts are arranged on your project. WalzCraft will review the material requirements and prepare a quote. Please see <i>Section G.17</i> for more information.
3	Ready to Assemble	Ready to Assemble (RTA) is <u>not</u> an option.

Continued on next page...

► For PRICING ► See Section **B.10** in our current Wholesale Pricing Catalog.

Technical Notes: Style 60 Veneered & Edgembanded Doors & Drawer Fronts...continued

Material Options

1	Hardwood Veneer	"A" grade (wood back) hardwood veneer on the face with a #1 grade (wood back) veneer on the back.
2	MDF Core	MDF material is visible on the outside edge profile, if left raw ( <b>EBT101</b> ). <ul style="list-style-type: none"> <li>This will generally appear darker than the face or back of the door when pre-finished.</li> </ul>
3	Combi-Core	¾" thick Style 60 doors and drawer fronts are also available with a Combi-Core. <ul style="list-style-type: none"> <li>See <b>Section K.I</b> for more information on Combi-Core.</li> <li>Available with all EBT options for ¾" thickness.</li> <li>Not available with pre-applied veneer.</li> <li>Frame-only options will still be made from solid wood.</li> </ul>
4	Reconstituted Veneer	See <b>Section B.II</b> for Style 60 doors using Architectural Grade Reconstituted Veneers.

Miscellaneous

1	EB Application Sequence	WalzCraft applies the edgembanding to the four edges in the following order: Top, Bottom, Left, Right.
2	Edgemband Grain Direction	WalzCraft applies the wood veneer edgembanding in a Lineal direction.

Profile Options (Chapter E)

1	EBT100	Wood veneer on face and back, ⅝" [14.5mm] thick only. <b>EBT100</b> is only available when using one of the following Applied Molding Outside Edge profiles for ⅝" thick Veneered & Edgembanded doors: <b>D68AM, D94AM, D99AM, D100AM, D111AM, D113AM, D121AM, D122AM, D136AM, D142AM, D150AM, D171AM, D173AM, D177AM, D197AM, D206AM.</b>
2	EBT101	<b>Slab:</b> Raw edge, wood veneer on face and back. Available with a <b>D7</b> outside edge profile ( <b>Section E.15</b> ).
		<b>Frame Only:</b> Raw edge, solid wood frame with veneer on the face and back. Available with a <b>D7</b> Outside Edge profile. Only available with <b>SR100GRF</b> Stile/Rail profile.
		<b>Frame Only-NPC:</b> Raw edge, MDF frame with veneer on the face and back. Available with a <b>D7</b> Outside Edge profile. Only available with <b>MP612-57-NPC</b> or <b>MP612-76-NPC</b> Stile/Rail profiles.
		<b>EBT101</b> is also available with the following Applied Molding Outside Edge profiles for ¾" thick Veneered & Edgembanded doors: <b>D80AM, D114AM, D132AM, D155AM, D159AM, D179AM, D198AM, D202AM, D209AM, D211AM, D212AM, D215AM.</b>
		<b>EBT101</b> is available 1" thick only when using one of the following Applied Molding Outside Edge profiles for 1" thick Veneered & Edgembanded doors: <b>D188AM, D189AM, D193AM, D196AM.</b> See notes for <b>Sizes /Dimensions - Thickness</b> for actual finished thickness.
3	EBT102	Maple wood veneer edgembanding, machine applied to a raw MDF panel. No veneer on face or back. Only available with a <b>D7</b> Outside Edge profile.
		This edgembanding option is recommended when a SolidTone® finish will be applied on raw MDF or MDF-MR doors and drawer fronts with a <b>D7</b> outside edge profile.
4	EBT103	⅛" [3.2mm] solid maple edgembanding, butt joinery at corners, machine applied to a raw MDF panel. No veneer on face or back. Only available with the following standard Outside Edge profiles from <b>Section E.15: D7, D33, D66, D147.</b>
		This edgembanding option is recommended when a SolidTone® finish will be applied on raw MDF or MDF-MR doors and drawer fronts with a <b>D7</b> outside edge profile.
5	EBT201	<b>Slab:</b> Wood veneer edgembanding, machine applied to a panel with veneer on the face and back. Only available with a <b>D7</b> Outside Edge profile.
		<b>Frame Only:</b> Wood veneer edgembanding, machine applied to a solid wood frame with veneer on the face and back. Only available with a <b>D7</b> Outside Edge profile. Only available with <b>SR100GRF</b> Stile/Rail profile.
		<b>Frame Only-NPC:</b> Wood veneer edgembanding, machine applied to an MDF frame with veneer on the face and back. Only available with a <b>D7</b> Outside Edge profile. Only available with <b>MP612-57-NPC</b> or <b>MP612-76-NPC</b> Stile/Rail profiles.
6	EBT202	<b>Slab:</b> ⅝" [3.2mm] solid wood edge, butt joinery at corners, machine applied to panel with veneer on the face & back. Only available with the following standard Outside Edge profiles from <b>Section E.15: D7, D33, D66, D147.</b>
		<b>Frame Only:</b> ⅝" [3.2mm] solid wood edge, butt joinery at corners, machine applied to solid wood frame with veneer on the face & back. Only available with the following standard Outside Edge profiles from <b>Section E.15: D7, D33, D66, D147.</b> Only available with <b>SR100GRF</b> Stile/Rail profile.
		<b>Frame Only-NPC:</b> ⅝" [3.2mm] solid wood edge, butt joinery at corners, machine applied to an MDF frame with veneer on the face & back. Only available with the following standard Outside Edge profiles from <b>Section E.15: D7, D33, D66, D147.</b> Only available with <b>MP612-57-NPC</b> or <b>MP612-76-NPC</b> Stile/Rail profiles.

Continued on next page...

Technical Notes: Style 60 Veneered & Edgebanded Doors & Drawer Fronts...continued

Profile Options (Chapter E)...continued

11	EBT501	<p><b>Slab:</b> Solid wood edge of variable width, butt joinery at corners, hand applied (tongue &amp; groove joint) to a panel with veneer on the face and back.</p>
		<p><b>Frame Only:</b> Solid wood edge of variable width, butt joinery at corners, hand applied (tongue &amp; groove joint) to a solid wood frame with veneer on the face and back. Only available with <b>SR100GRF</b> Stile/Rail profile.</p>
		<p><b>Frame Only-NPC:</b> Solid wood edge of variable width, butt joinery at corners, hand applied (tongue &amp; groove joint) to an MDF frame with veneer on the face and back. Only available with <b>MP612-57-NPC</b> or <b>MP612-76-NPC</b> Stile/Rail profiles.</p>
		<p>Width of solid wood edge varies from 3/8" [9.5mm] to a maximum of 1/4" [31.8mm], in 1/8" [3.2mm] increments and is determined by your chosen outside edge profile.</p> <ul style="list-style-type: none"> <li>• Standard width is 3/8" [9.5mm].</li> <li>• Available with all standard Outside Edge profiles from <i>Section E.15 except: D72, D138, D152.</i></li> <li>• For your reference, you can also access the <b>Profile Reveal Widths</b> chart on our website: <b>Resources &gt; Technical Information &gt; Technical Information.</b></li> </ul>
12	EBT601	<p><b>Slab:</b> Solid wood edge of variable width, with mitered corners, hand applied (tongue &amp; groove joint) to a panel with veneer on the face and back.</p>
		<p><b>Frame Only:</b> Solid wood edge of variable width, with mitered corners, hand applied (tongue &amp; groove joint) to a solid wood frame with veneer on the face and back. Only available with <b>SR100GRF</b> Stile/Rail profile.</p>
		<p><b>Frame Only-NPC:</b> Solid wood edge of variable width, with mitered corners, hand applied (tongue &amp; groove joint) to an MDF frame with veneer on the face and back. Only available with <b>MP612-57-NPC</b> or <b>MP612-76-NPC</b> Stile/Rail profiles.</p>
		<p>Width of solid wood edge varies from 3/8" [9.5mm] to a maximum of 1/4" [31.8mm], in 1/8" [3.2mm] increments and is determined by the chosen outside edge profile.</p> <ul style="list-style-type: none"> <li>• Standard width is 3/8" [9.5mm].</li> <li>• Available with all standard Outside Edge profiles from <i>Section E.15 except: D72, D138, D152.</i></li> <li>• For your reference, you can also access the <b>Profile-Reveal Widths</b> chart on our website: <b>Resources / Technical Information &gt; Technical Information.</b></li> </ul>
13	EBT701	<p><b>Slab:</b> Solid wood edge of variable width, with mitered corners, hand applied (tongue &amp; groove joint) to a raw MDF panel.</p> <ul style="list-style-type: none"> <li>• Face and back veneer is applied after edgebanding.</li> <li>• Width of the solid wood edge will equal the outside edge profile width + 1/8" [3.2mm].                             <ul style="list-style-type: none"> <li>◦ Minimum width of 3/4" [19.1mm] wide (does not include tongue &amp; groove joint).</li> <li>◦ Maximum width of 1 1/4" [31.8mm] wide (does not include tongue &amp; groove joint).</li> </ul> </li> <li>• Minimum size for raw MDF panel before applying solid wood edge is 3" x 3" [76.2mm x 76.2mm].</li> </ul>
		<p><b>Frame Only:</b> Solid wood frame with mitered corners. Face and back veneer is applied after frame is assembled. Only available with <b>MP612-57GRF</b> or <b>MP612-76GRF</b> Stile/Rail profile.</p>
		<p><b>Frame Only-NPC:</b> Solid wood frame with mitered corners. Face and back veneer is applied after frame is assembled. Only available with <b>MP612-57-NPC</b> or <b>MP612-76-NPC</b> Stile/Rail profile.</p>
		<p>Due to the shape of the profile where the solid wood edge meets the veneer face, not all outside edge profiles are available.</p> <ul style="list-style-type: none"> <li>• For compatible outside edge profiles, please see the <b>Outside Edge Profile Compatibility</b> chart on our website: <b>Resources &gt; Technical Information &gt; Compatibility Charts.</b></li> </ul>

Continued on next page...

► For PRICING ► See Section [B.10](#) in our current Wholesale Pricing Catalog.



Technical Notes: Style 60 Veneered & Edgedbanded Doors & Drawer Fronts...continued

Sizes/Dimensions

1	Thicknesses	<p><b>1/16" Style 60:</b> Available only when using <b>EBT100</b> and one of the compatible Applied Molding Outside Edge profiles for 1/16" thick Veneered &amp; Edgedbanded doors.</p> <ul style="list-style-type: none"> <li>• 1/16" <b>Style 60</b> doors will finish at .572" [14.5mm] thick +/- .030".</li> <li>• Not available with Pre-Applied veneer.</li> </ul>
		<p><b>3/4" Style 60:</b> Available with all <b>EBT</b> options, including frame only doors, except <b>EBT100</b>.</p> <ul style="list-style-type: none"> <li>• Includes raw MDF-MR for <b>EBT102</b> and <b>EBT103</b>.</li> <li>• Also available with <b>EBT101</b> and one of the compatible Applied Molding Outside Edge profiles for 3/4" thick Veneered &amp; Edgedbanded doors.</li> <li>• 3/4" <b>Style 60</b> doors will finish at .759" [19.3mm] thick +/- .030".</li> </ul>
		<p><b>1" Style 60:</b> Available when using any of the following solid wood edged <b>EBT</b> options: <b>EBT202, EBT501, EBT601, EBT701</b> (includes frame only doors).</p> <ul style="list-style-type: none"> <li>• Also available with <b>EBT101</b> and one of the compatible Applied Molding Outside Edge profiles for 1" thick Veneered &amp; Edgedbanded doors.</li> <li>• <b>1" Style 60</b> doors will finish at 0.947" [24.1mm] thick +/- .030".</li> <li>• Not available with Pre-Applied veneer.</li> </ul>
2	Maximum Size	<p><b>Vertical Grain</b> = 48"W x 96"H [1219.2mm x 2438.4mm].</p>
		<p><b>Horizontal Grain</b> = 96"W x 48"H [2438.4mm x 1219.2mm].</p>
		<p>The maximum width for Style 60 doors/drawer fronts that WalzCraft will warrant is 24". The maximum height for Style 60 doors/drawer fronts that WalzCraft will warrant is 72".</p> <ul style="list-style-type: none"> <li>• Sizes greater than this will carry no warranty against warping or twisting.</li> <li>• See <b>Section A.8</b> for more information on warping and twisting tolerances.</li> </ul>

Wood Species Options (Chapter S)

1	EBT102, EBT201, EBT201-F	<p>Not all veneer used for the face and back of these doors have a matching veneer edgeband species. Please see <b>Edgebanding Species for EBT Style 60</b> chart on our website under <b>Resources &gt; Technical Information &gt; Technical Information</b> to find which species of veneer edgebanding will be used with the various species of face/back veneer.</p>
2	Solid Wood Edgebanding	<p>Due to the nature of solid wood, when preparing a piece of solid wood edgebanding to apply to the edge of a door, the face and back surfaces of the individual solid wood piece will have a plain sawn grain pattern, and the remaining surfaces of the piece (at a 90° angle to the face and back), will have a different grain pattern, such as quarter sawn or straight grain.</p> <ul style="list-style-type: none"> <li>• See earlier page within this section for images of the orientation of that piece of edgebanding in relation to the face veneer on the door. This will show you which grain pattern will be visible from the face of the completed door and which grain pattern will be visible from the edge of the completed door.</li> </ul>

Veneered & Edgedbanded - Standard Veneer - END

► For PRICING ► See Section [B.10](#) in our current Wholesale Pricing Catalog.

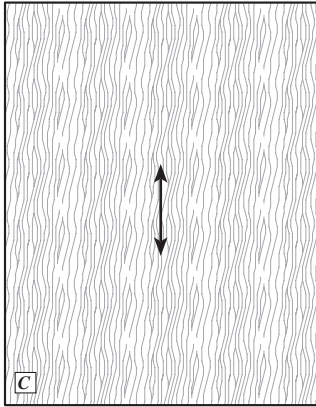

Style: 60  
PC: See EBT Options

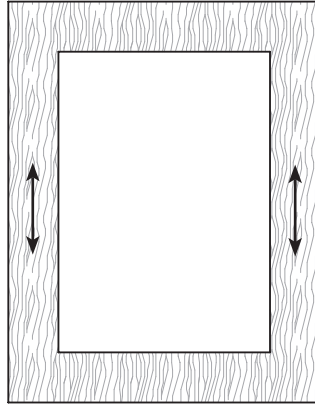

Style: 60F Frame Only  
PC: See EBT Options

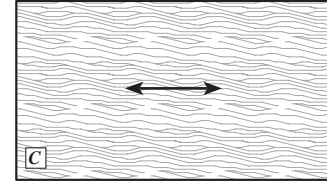

Style: 60 Drawer Front  
PC: See EBT Options

EBT201-R Family (Wood Veneer Edge - Machine Applied)

EBT201-R

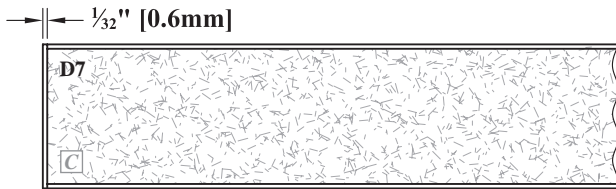

- Only available with **D7** Outside Edge Profile.

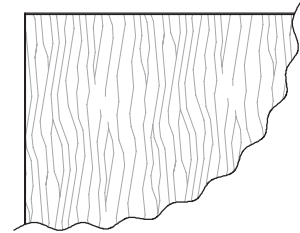

Minimum Size: 3" x 3" [76.2mm x 76.2mm] after edgebanding.

EBT201-R - Frame Only

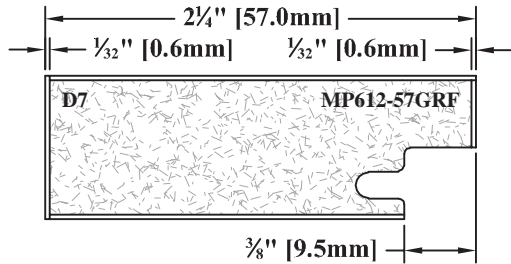

- Only available with **D7** Outside Edge Profile.
- Only available with **MP612-57GRF** or **MP612-76GRF** Stile/Rail Profile.

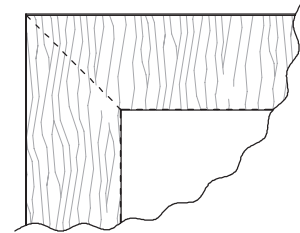

Minimum Size: 6" x 6" [152.4mm x 152.4mm] after edgebanding.

EBT201-R - Frame Only - NPC

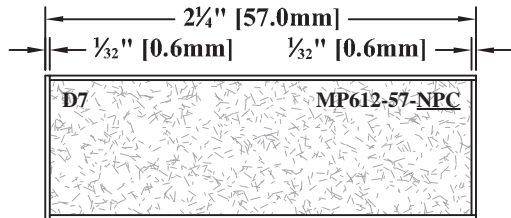

- Only available with **D7** Outside Edge Profile.
- Only available with **MP612-57-NPC** or **MP612-76-NPC** Stile/Rail Profile.

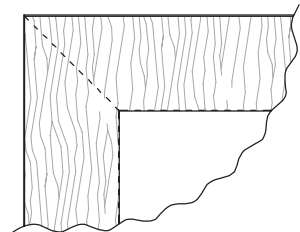

Minimum Size: 6" x 6" [152.4mm x 152.4mm] after edgebanding.

Continued on next page...

► For PRICING ► See Section [B.11](#) in our current Wholesale Pricing Catalog.

EBT101-R (*Raw Edge*)

B

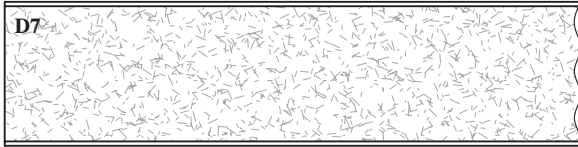

- Only available with **D7** Outside Edge Profile.

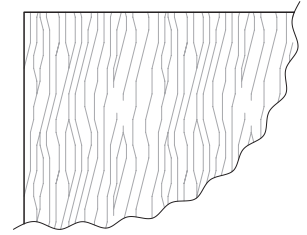

Minimum Size: 3" x 3" [76.2mm x 76.2mm]

Continued on next page...

► For PRICING ► See Section [B.11](#) in our current Wholesale Pricing Catalog.

## Ordering &amp; Pricing Notes: Veneered &amp; Edgebanded - Reconstituted Veneer

## Ordering Guidelines

1	Order Forms	Please use <i>Veneered &amp; Edgebanded Door and Drawer Front Order Form (E•Z Form #7)</i> .
<b>Pricing</b>		
1	Pricing	Please see <i>Section B.11</i> of our current <b>Wholesale Pricing Catalog</b> .

## Technical Notes: Veneered &amp; Edgebanded - Reconstituted Veneer

## Cabinet Door &amp; Drawer Front Options (Chapter B)

1	Frame Only Doors	Not available with mullion lite patterns.
		Not available with center stiles or rails.
		<b>GRF</b> cut is designed to accept our rubber glass retainer. See <i>Section B.12</i> for more information.

## Convex/Concave Options (Chapter D)

1	Available Products	The  indicates that this product is available convex/concave. <ul style="list-style-type: none"> <li>• <b>EBT201-R</b> is the only edgeband treatment option available.</li> <li>• Frame only doors are not available convex/concave.</li> </ul>
2	Edgebanding	In the case of convex/concave doors and drawer fronts, the edgebanding will be hand applied.
		Lineal grain direction on the top and bottom edge of a convex/concave door will run in a straight line. <ul style="list-style-type: none"> <li>• The grain will not follow the radius.</li> </ul>

## Dealer Aid Options (Chapter T)

1	Unfinished Sample Set	Set includes one unfinished 3 3/8" x 5 1/4" [92.1mm x 133.4mm] paper back Reconstituted veneer sample in each of our available wood species. See <i>Dealer Aids Section T.1</i> .
2	Finished Color Blocks	See <i>Dealer Aid Section T.1</i> for finished color samples.

## Design Options (Chapter G)

1	Grain & Color Coordination	Grain and Color Coordination is an option for veneer doors. <ul style="list-style-type: none"> <li>• WalzCraft only offers this option in conjunction with <b>EBT201-R</b>.</li> <li>• <b>EBT201-R Frame Only</b> doors are <u>not</u> available with Grain and Color Coordination.</li> <li>• Please see <i>Section G.17</i> for more information.</li> </ul>
---	----------------------------	--

## Functional Options (Chapter F)

1	Hinge Boring	Hinge boring is available for Style 60 Veneered & Edgebanded - Reconstituted Veneer doors & drawer fronts. <ul style="list-style-type: none"> <li>• Please see <i>Section F.1</i> for additional hinge boring requirements, ordering instructions and compatibility.</li> </ul>
2	Finger Pull Moldings	Finger Pull Moldings <i>can only be used</i> with <b>EBT</b> options if using a <b>D7</b> outside edge profile.
		Not all <b>EBT</b> options are compatible. Please see the <b>EBT - Fingerpull Molding Compatibility</b> chart on our website: <b>Resources &gt; Technical Information &gt; Compatibility Charts</b> .

## General Information (Chapter A)

1	Grain Direction	Arrows (←→) throughout the catalog indicate standard grain direction. Grain direction may be specified at <b>NO</b> additional cost (includes frame only doors).
2	Horizontal Grain	If your project is being ordered with Horizontal grain and there are multiple doors and/or drawer fronts adjacent to each other, WalzCraft strongly suggests that you consider using our Grain and Color Coordination option. Please supply Walz-Craft with a drawing or sketch of how the doors and drawer fronts are arranged on your project. WalzCraft will review the material requirements and prepare a quote. Please see <i>Section G.17</i> for more information.
3	Ready to Assemble	Ready to Assemble (RTA) is <u>not</u> an option.

## Material Options

1	Reconstituted Veneer	Reconstituted Veneer (paper back) on face, back and edges.
2	MDF Core	MDF material is visible on the outside edge profile, if left raw ( <b>EBT101</b> ). This will generally appear darker than the face or back of the door when pre-finished.
3	Combi-Core	3/4" thick Reconstituted Veneer Style 60 doors and drawer fronts are also available with a Combi-Core. See <i>Section K.1</i> for more information on Combi-Core. <ul style="list-style-type: none"> <li>• Available with all EBT options for 3/4" thickness.</li> <li>• Not available with Frame-only options.</li> </ul>

Continued on next page...

► For PRICING ► See Section [B.11](#) in our current Wholesale Pricing Catalog.

*Technical Notes: Veneered & Edgedbanded - Reconstituted Veneer...continued*

*Miscellaneous*

1	<b>EB Application Sequence</b>	WalzCraft applies the edgedbanding to the four edges in the following order: Top, Bottom, Left, Right.
2	<b>Edgedband Grain Direction</b>	WalzCraft applies the wood veneer edgedbanding in a Lineal direction.

*Profile Options (Chapter E)*

1	<b>EBT101-R</b>	Raw Edge, Reconstituted wood veneer on face and back of MDF panel. Only available with a <b>D7</b> outside edge.
2	<b>EBT201-R</b>	<b>Slab:</b> Reconstituted wood veneer edgedbanding, machine applied to an MDF panel with veneer on the face and back. Only available with a <b>D7</b> outside edge.
		<b>Frame Only:</b> Reconstituted wood veneer edgedbanding, machine applied to an MDF frame with veneer on the face and back. Mitered corners. Only available with a <b>D7</b> outside edge. Only available with <b>MP612-57GRF</b> or <b>MP612-76GRF</b> Stile/Rail profile. If stile widths differ from rail widths, traditional mortise & tenon construction will be used.
		<b>Frame Only-NPC:</b> Reconstituted wood veneer edgedbanding, machine applied to an MDF frame with veneer on the face and back. Mitered corners. Only available with a <b>D7</b> outside edge. Only available with <b>MP612-57-NPC</b> or <b>MP612-76-NPC</b> Stile/Rail profile. If stile widths differ from rail widths, traditional mortise & tenon construction will be used.

*Sizes/Dimensions*

1	<b>Thickness</b>	Only available 3/4" [19.3mm] thick (includes frame only doors).
2	<b>Maximum Size</b>	<b>Vertical Grain</b> = 48"W x 96"H [1219.2mm x 2438.4mm].
		<b>Horizontal Grain</b> = 96"W x 48"H [2438.4mm x 1219.2mm].
		The maximum width for Style 60 doors/drawer fronts that WalzCraft will warrant is 24". The maximum height for Style 60 doors/drawer fronts that WalzCraft will warrant is 72". • Sizes greater than this will carry no warranty against warping or twisting. • See <i>Section A.8</i> for more information on warping and twisting tolerances.

*Veneered & Edgedbanded - Reconstituted Veneer - END*

► For PRICING ► See Section [B.11](#) in our current Wholesale Pricing Catalog.

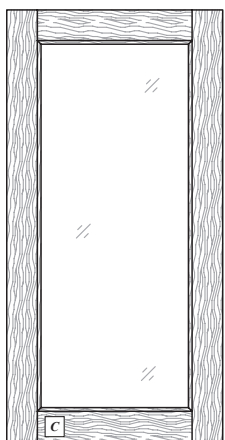

Style 10  
Frame Door

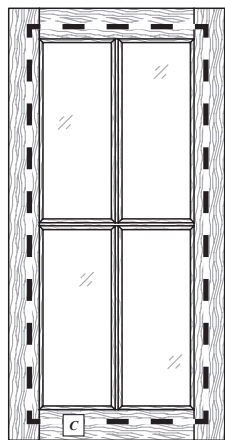

Style 10  
LP001 - 4 Lites  
2 wide x 2 high

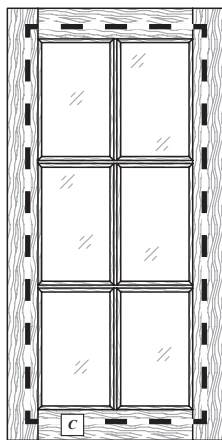

Style 10  
LP001 - 6 Lites  
2 wide x 3 high

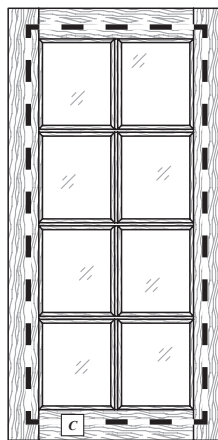

Style 10  
LP001 - 8 Lites  
2 wide x 4 high

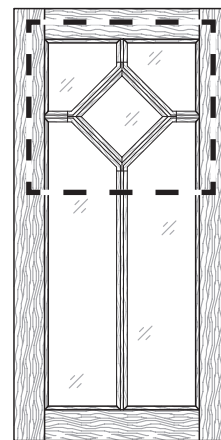

Style 10  
LP100 - 5 Lites

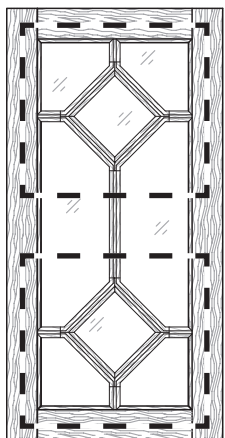

Style 10  
LP100 - (2) Patterns  
8 Lites

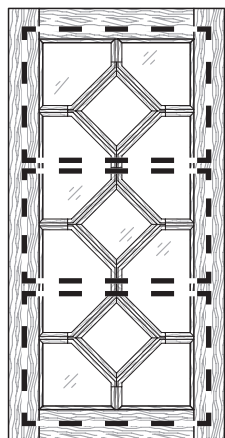

Style 10  
LP100 - (3) Patterns  
11 Lites

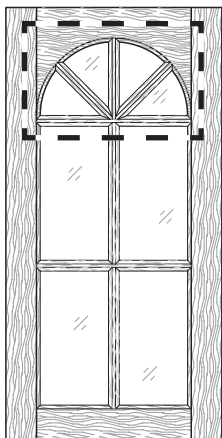

Style 1996  
LP101 over 2wx2h Lites  
8 Lites

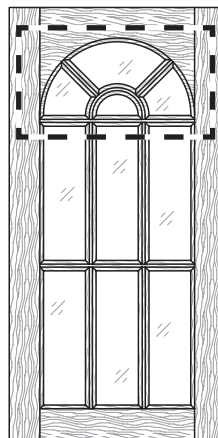

Style 1996  
LP102 over 3wx2h Lites  
10 Lites

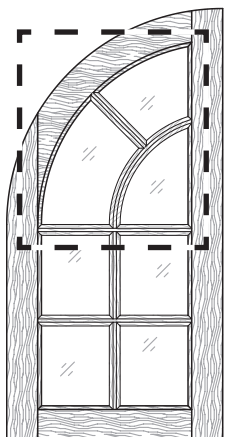

Style 995L  
LP103 over 2wx2h Lites  
7 Lites

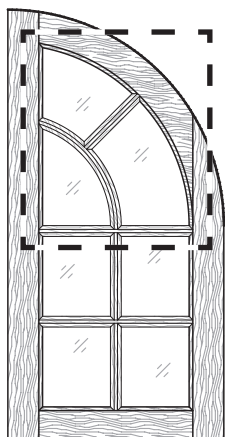

Style 995R  
LP103 over 2wx2h Lites  
7 Lites

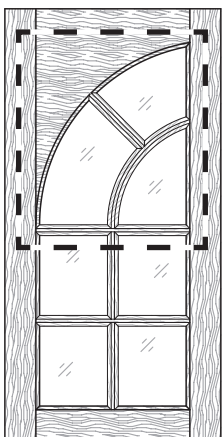

Style 996L  
LP103 over 2wx2h Lites  
7 Lites

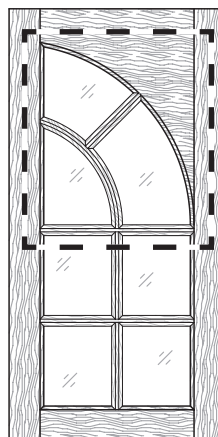

Style 996R  
LP103 over 2wx2h Lites  
7 Lites

► For PRICING ► See Section B.12 in our current Wholesale Pricing Catalog.

Mullion Lite Pattern Options

B

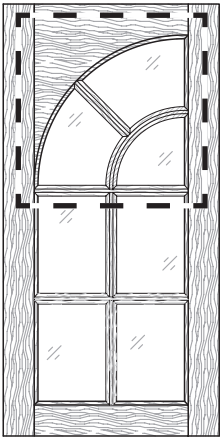

**Style 997L**  
LP104 over 2wx2h Lites  
7 Lites

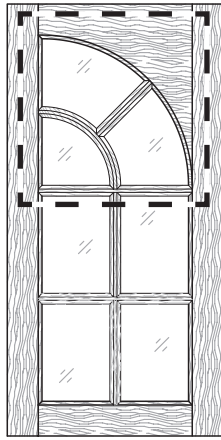

**Style 997R**  
LP104 over 2wx2h Lites  
7 Lites

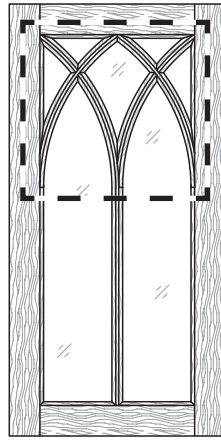

**Style 10**  
LP105 - 7 Lites

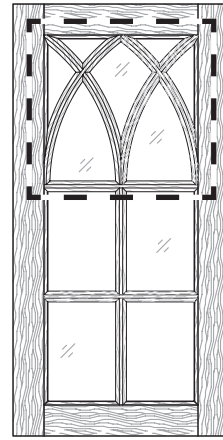

**Style 10**  
LP105 over 2wx2h Lites  
11 Lites

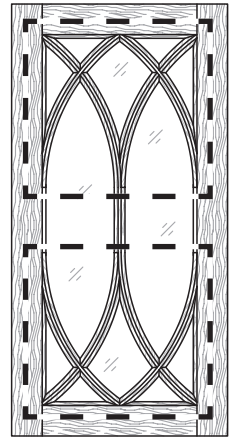

**Style 10**  
LP105 - (2) Patterns  
12 Lites

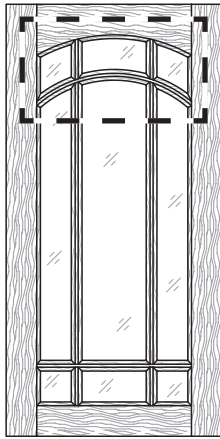

**Style 2000**  
LP106 - 9 Lites

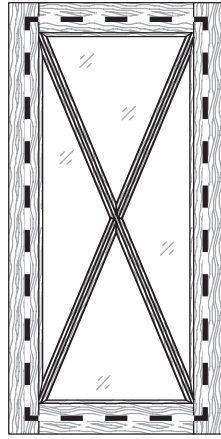

**Style 10**  
LP107 - 4 Lites

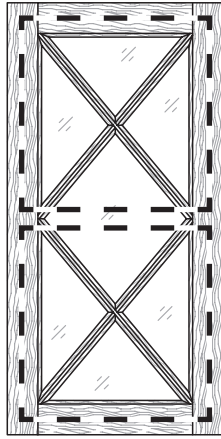

**Style 10**  
LP107 - (2) Patterns  
7 Lites

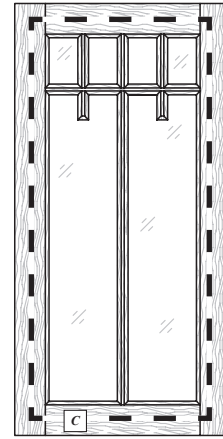

**Style 10**  
LP108 - 6 Lites

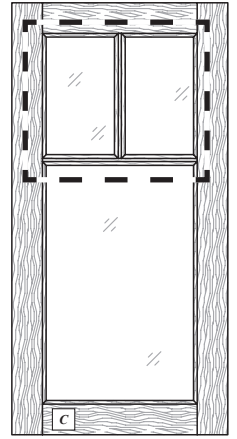

**Style 10**  
LP109 - 3 Lites

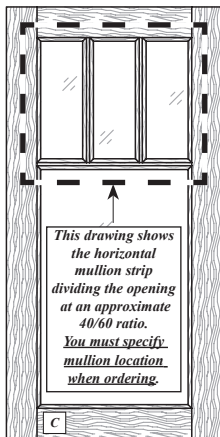

This drawing shows the horizontal mullion strip dividing the opening at an approximate 40/60 ratio. You must specify mullion location when ordering.

**Style 10**  
LP109 - 4 Lites

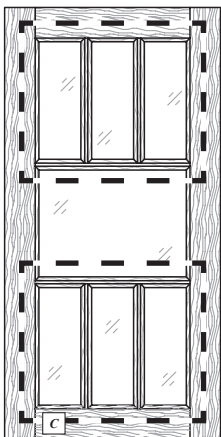

**Style 10**  
LP109 - (2) Patterns  
7 Lites

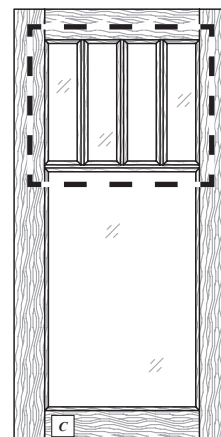

**Style 10**  
LP109 - 5 Lites

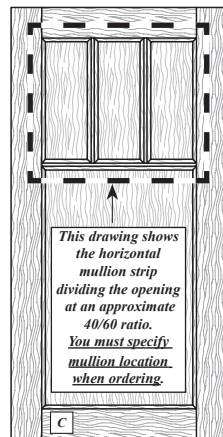

**Style 40MUL**  
w/LP109 - 4 Lites

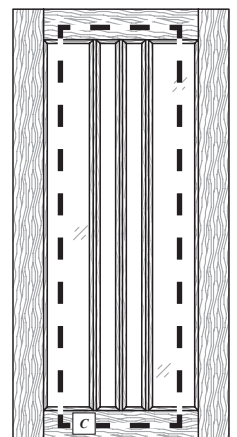

**Style 10**  
LP110 - 4 Lites

► For PRICING ► See Section B.12 in our current Wholesale Pricing Catalog.

Mullion Lite Pattern Options

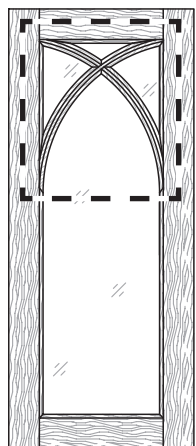

Style 10  
LP111 - 4 Lites  
(Drawn at: 12"W x 28"H)  
[304.8mm x 711.2mm]

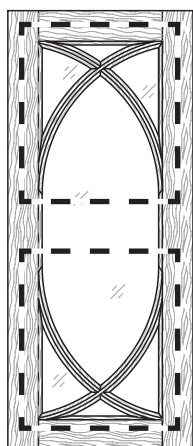

Style 10  
LP111 - (2) Patterns  
7 Lites  
(Drawn at: 12"W x 28"H)  
[304.8mm x 711.2mm]

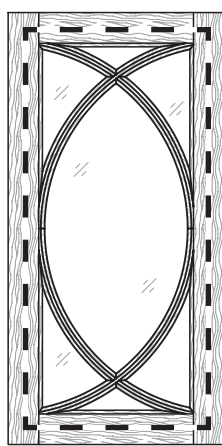

Style 10  
LP112 - 7 Lites

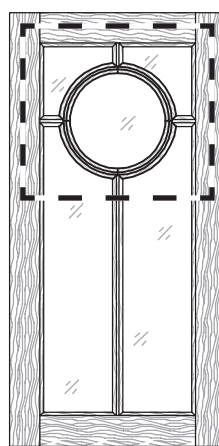

Style 10  
LP113 - 5 Lites

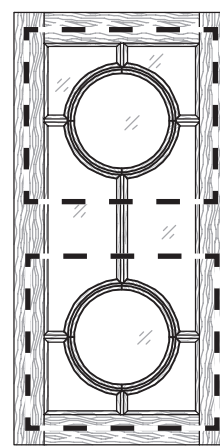

Style 10  
LP113 - (2) Patterns  
8 Lites

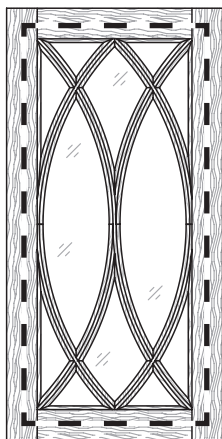

Style 10  
LP114 - 12 Lites

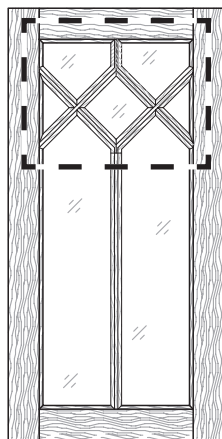

Style 10  
LP115 - 7 Lites

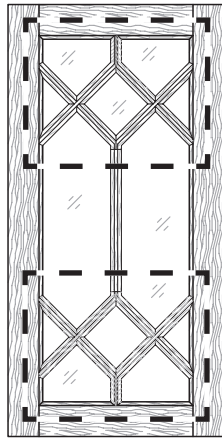

Style 10  
LP115 - (2) Patterns  
12 Lites

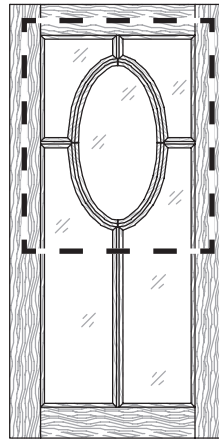

Style 10  
LP116 - 5 Lites

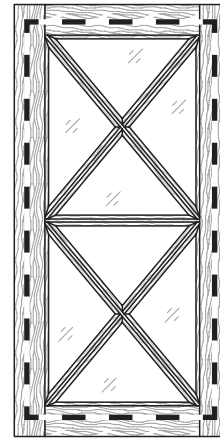

Style 10  
LP117 - 8 Lites

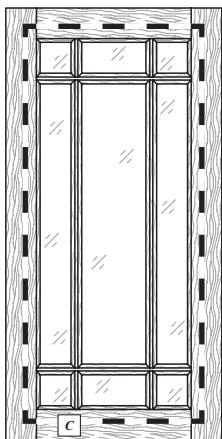

Style 10  
LP118 - 9 Lites

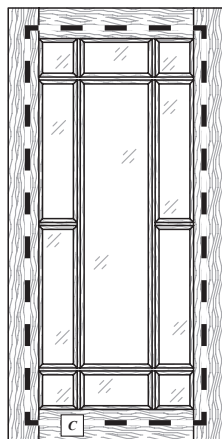

Style 10  
LP118 - 11 Lites

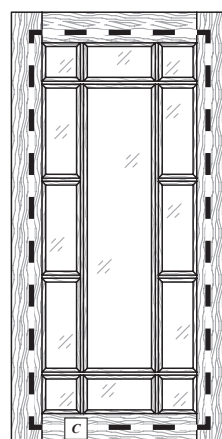

Style 10  
LP118 - 13 Lites

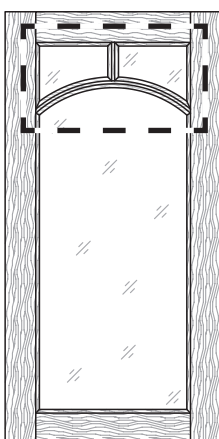

Style 10  
LP119 - 3 Lites

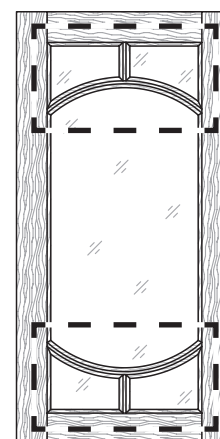

Style 10  
LP119 - (2) Patterns  
5 Lites

► For PRICING ► See Section B.12 in our current Wholesale Pricing Catalog.

Mullion Lite Pattern Options

B

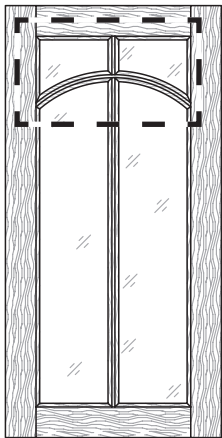

Style 10  
LP120 - 4 Lites

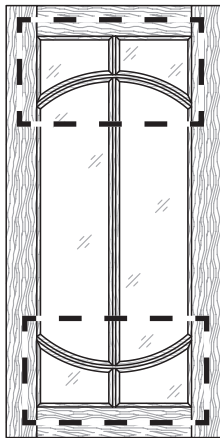

Style 10  
LP120 - (2) Patterns  
6 Lites

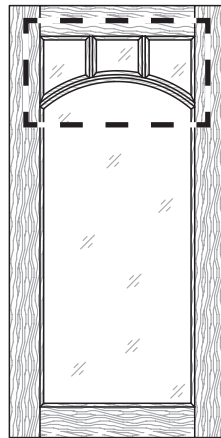

Style 10  
LP121 - 4 Lites

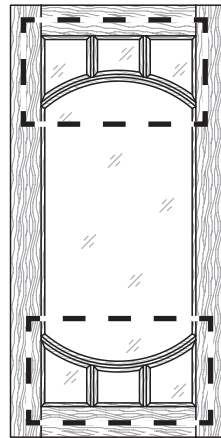

Style 10  
LP121 - (2) Patterns  
7 Lites

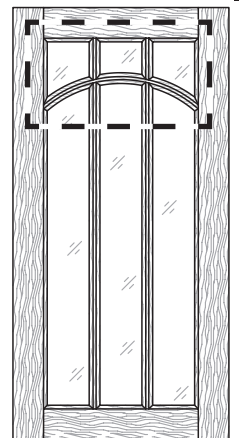

Style 10  
LP122 - 6 Lites

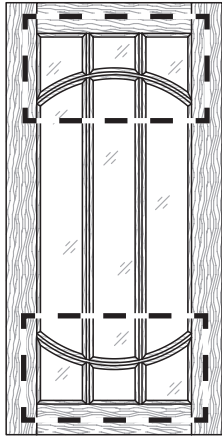

Style 10  
LP122 - (2) Patterns  
9 Lites

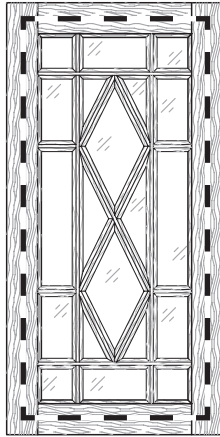

Style 10  
LP124 - 20 Lites

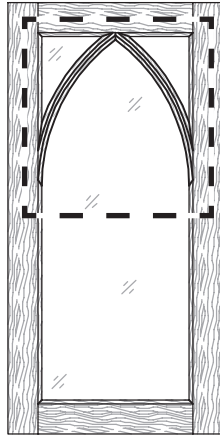

Style 10  
LP125 - 3 Lites

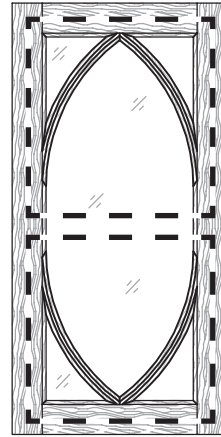

Style 10 - LP125  
(2) Patterns  
5 Lites

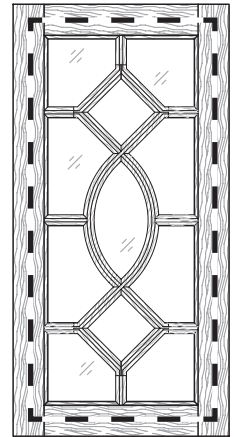

Style 10 - LP126  
11 Lites

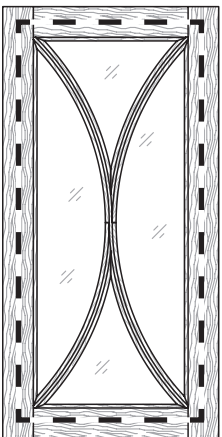

Style 10 - LP127  
4 Lites

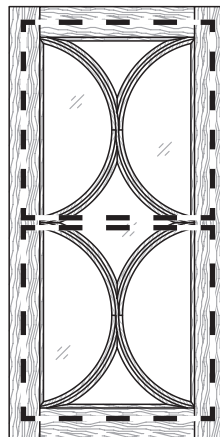

Style 10 - LP127  
(2) Patterns  
7 Lites

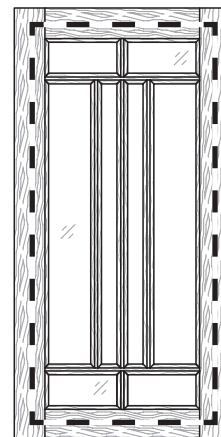

Style 10 - LP128  
8 Lites

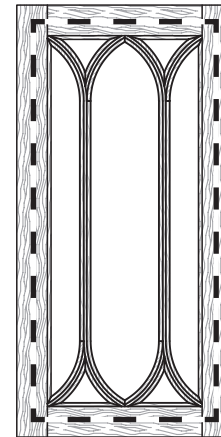

Style 10 - LP129  
7 Lites

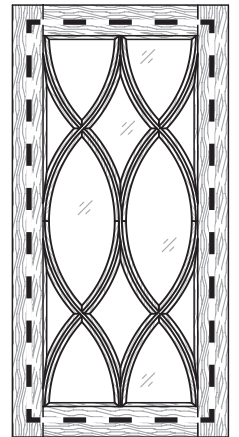

Style 10 - LP130  
12 Lites

► For PRICING ► See Section B.12 in our current Wholesale Pricing Catalog.

Mullion Lite Pattern Options

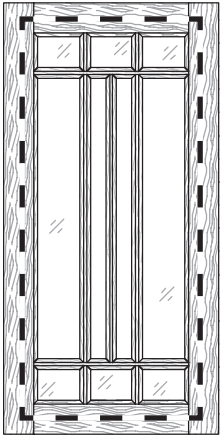

Style 10  
LP131 - 10 Lites

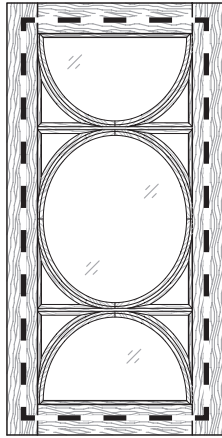

Style 10  
LP132 - 11 Lites

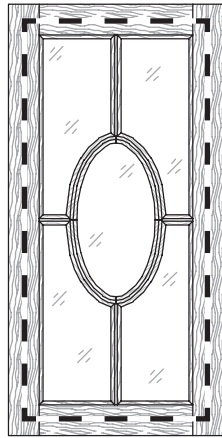

Style 10  
LP133 - 5 Lites

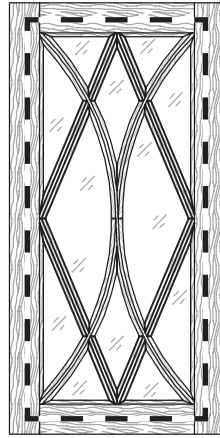

Style 10  
LP134 - 12 Lites

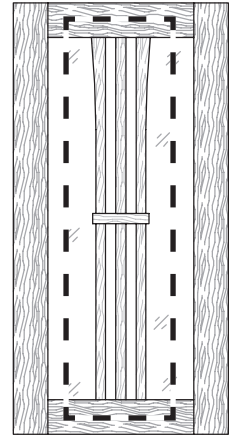

Style 10  
LP136 - 6 Lites

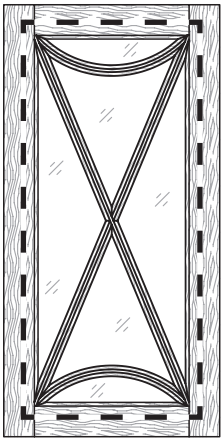

Style 10  
LP137 - 6 Lites

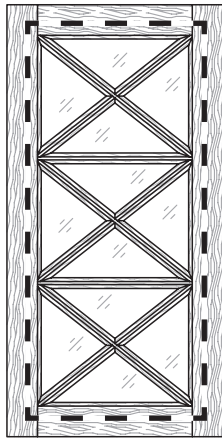

Style 10  
LP138 - 12 Lites

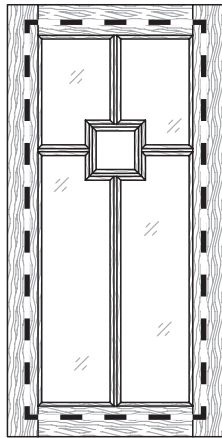

Style 10  
LP139 - 5 Lites

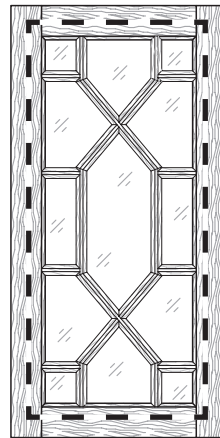

Style 10  
LP140 - 13 Lites

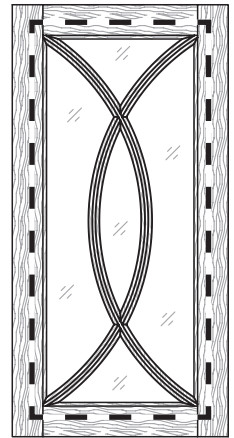

Style 10  
LP141 - 5 Lites

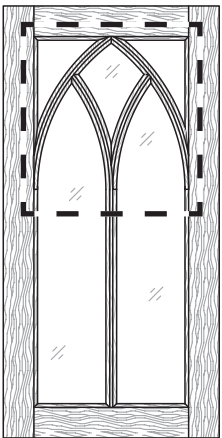

Style 10  
LP142 - 5 Lites

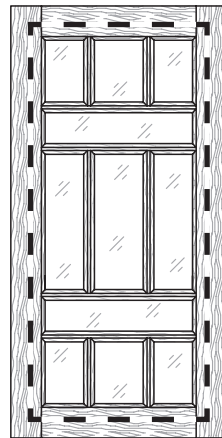

Style 10  
LP143 - 11 Lites

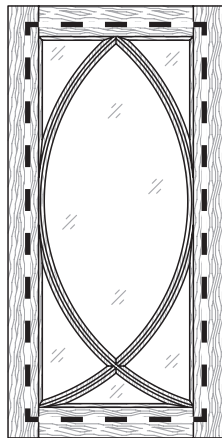

Style 10  
LP144 - 6 Lites

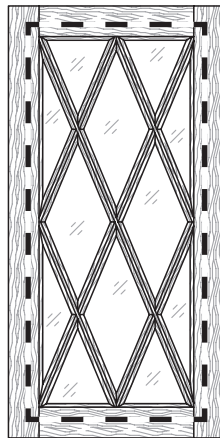

Style 10  
LP145 - 12 Lites

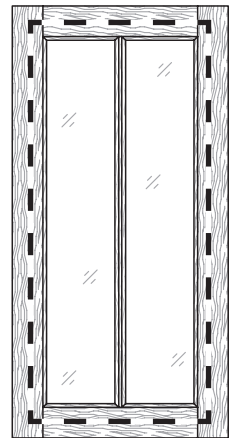

Style 10  
LP146 - 2 Lites  
2 wide x 1 high

► For PRICING ► See Section B.12 in our current Wholesale Pricing Catalog.

Mullion Lite Pattern Options

B

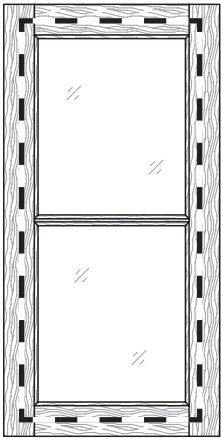

Style 10  
LP147 - 2 Lites  
1 wide x 2 high

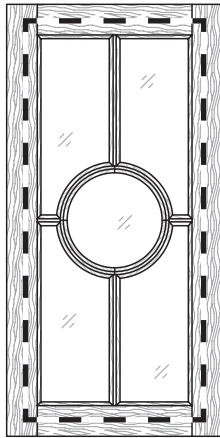

Style 10  
LP148 - 5 Lites

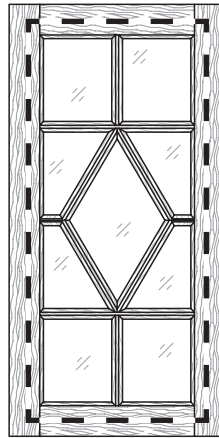

Style 10  
LP149 - 9 Lites

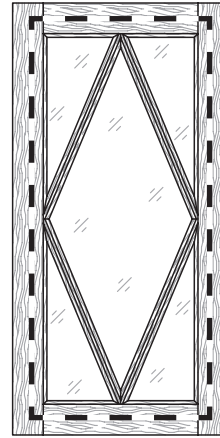

Style 10  
LP150 - 5 Lites

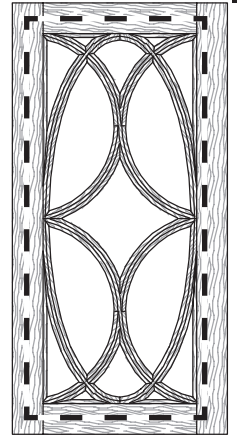

Style 10  
LP151 - 15 Lites

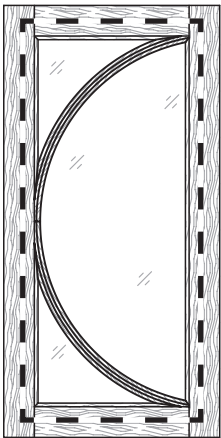

Style 10  
LP152 - 3 Lites

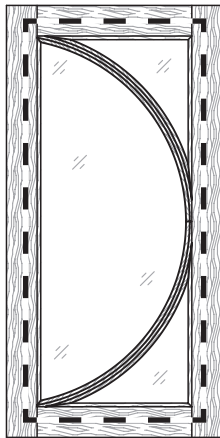

Style 10  
LP153 - 3 Lites

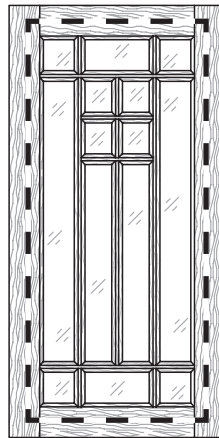

Style 10  
LP154 - 14 Lites

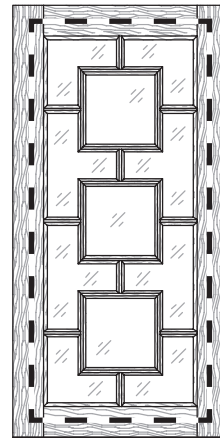

Style 10  
LP155 - 11 Lites

LP123 Lite Pattern Configuration Options

\*\* Doors using the LP123 lite pattern are available from 12" to 24" wide in 1" increments. Please see Notes for more information. \*\*

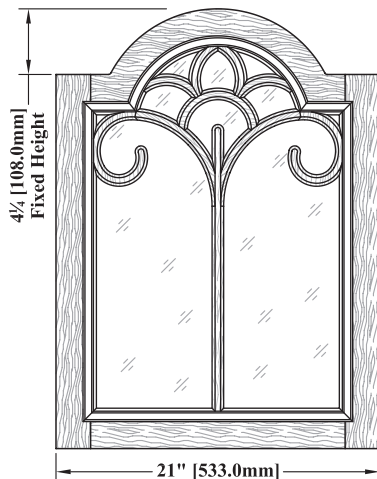

Style 3020  
LP123 - 10 Lites

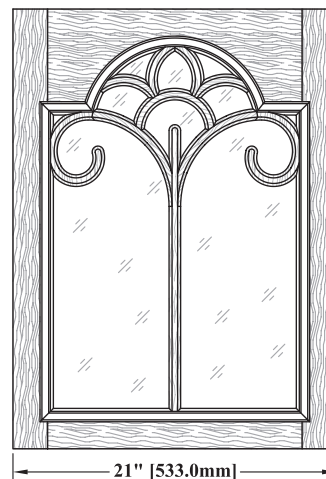

Style 3022  
LP123 - 10 Lites

**Formula for Glass Size Calculation**

1) Formula used to calculate the width/height of rectangular shaped glass to fit a single opening WalzCraft frame with straight stile and rail parts (does not include French Miter doors):

- Glass Width = [Door Width - (stile width x 2)] + [ $\frac{3}{8}$ " (GRF width) x 2] - [ $\frac{1}{16}$ " (Frame/Glass Gap Width) x 2]
- Glass Height = [ Door Height - (rail width x 2)] + [ $\frac{3}{8}$ " (GRF width) x 2] - [ $\frac{1}{16}$ " (Frame/Glass Gap Width) x 2]

2) To calculate the width/height of rectangular shaped glass to fit a frame provided by another source, or a WalzCraft frame with multiple openings with straight stile and rail parts:

- From the back side of your frame, measure the frame cavity opening (width & height) where the glass will set into the frame.
- Deduct  $\frac{1}{8}$ " ( $\frac{1}{16}$ " frame/glass gap width x 2) from your width and height dimension.

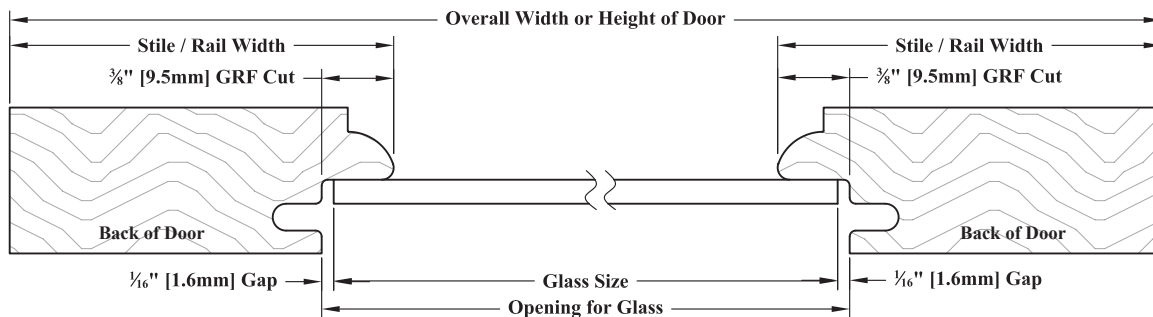

\*See *Sizes/Dimensions* notes for frame & mullion doors later in this section for more information on calculating glass sizes.

\*See notes in *Section B.7* to calculate glass sizes for French Mitered door frames.

**Mullion Construction**

WalzCraft may use a variety of joinery methods when constructing our mullion lite patterns. Our goal is to achieve the strongest connection to the door frame and to the other mullions within the pattern. The chosen lite pattern, mullion molding profile, door size, and wood species are all factors that are considered when choosing the best joinery method. One method is our half lap construction. Show at the right, it provides a very strong joint and is used on patterns where mullions cross over one another at right angles.

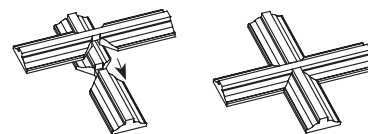

**Rubber Glass Retainer**

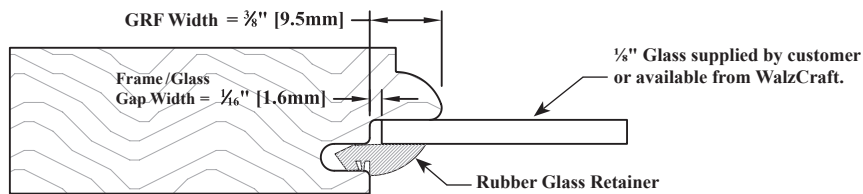

- Please see *Section B.12* of our current **Wholesale Pricing Catalog** for glass retainer lineal foot pricing.
- Glass retainer fits into a slot, as shown in the drawing above, and can only be used with  $\frac{1}{8}$ " [3.2mm] glass.
- True Lite mullions **are not constructed with a slot to accept rubber glass retainer.**
- Glass retainer is available in black, brown, white and clear.
- To order retainer with a frame only door, simply check the box on *Door Order Form #2* indicating which color you would like and our Configurator will calculate the amount needed.
- To order retainer by itself, please use *Miscellaneous Order Form #5* and part #155067. Simply enter the color into the *Description* field, and then enter the total required amount of lineal feet into the *quantity* field (qty).
  - You may order the glass retainer by the lineal foot or in full rolls (both are priced the same).
  - White is available in 500 foot rolls.
  - Black, brown and clear are available in 1,000 foot rolls.
- Occasionally, due to the rubber retainer manufacturing process/tolerances, you may find that your retainer is slightly loose in an area. Should this occur, WalzCraft recommends adding a small bead of glue or caulk in this spot to help secure the retainer.

► For PRICING ► See Section B.12 in our current Wholesale Pricing Catalog.

Mullion Lite Option 1 - Standard Lite

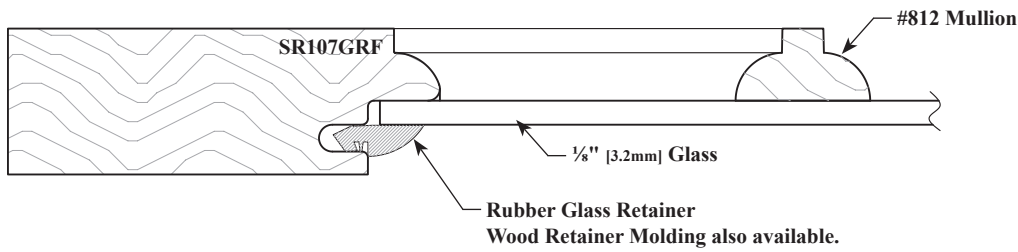

Mullion Lite Option 2 - True Lite with Divider Molding

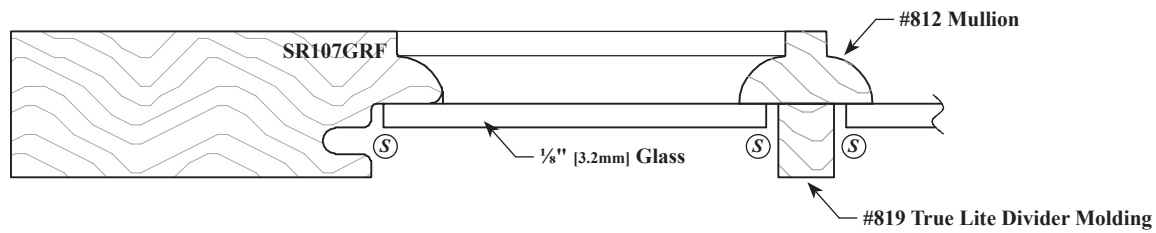

Mullion Lite Option 3 - True Lite Retainer Groove (TLRG)

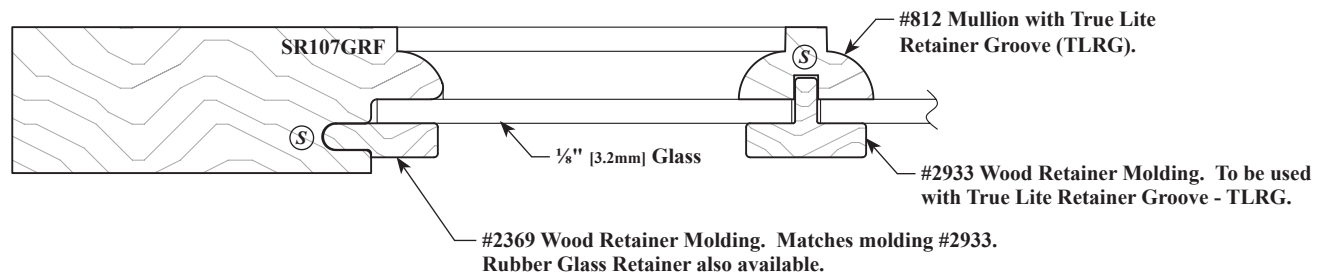

(S) = WalzCraft recommends using silicone caulk to secure the wood retainer molding and/or glass. Please see *Notes* for more information.

► For PRICING ► See Section B.12 in our current Wholesale Pricing Catalog.

Wood Retainer Molding (Cut to Size)

For 3/4" [19.1mm] Doors

For 1" [25.4mm] Doors

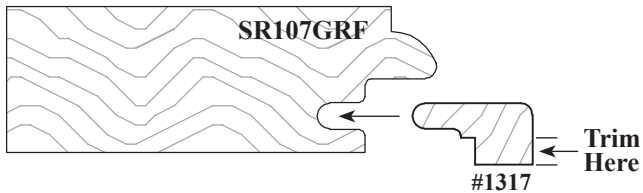
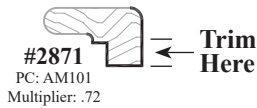
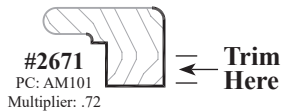
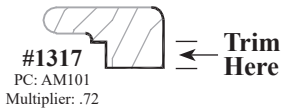
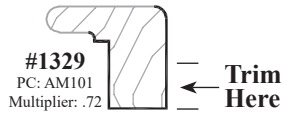

Wood Retainer Molding (Cut to Size)

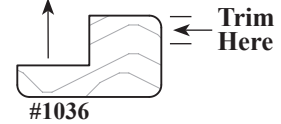
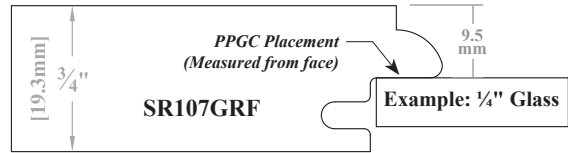
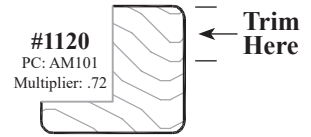
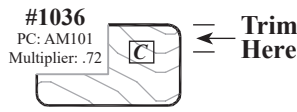

See Notes for more information.

Wood Retainer Molding (Cut to Size)

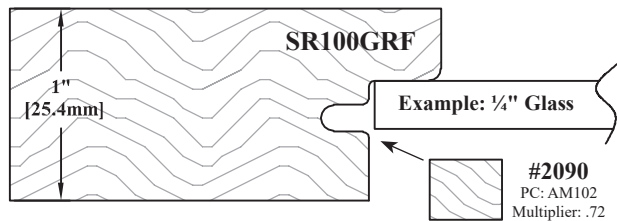

Note: SR100GRF shown at 1" thick.

Wood Tenon Filler Molding (Cut to Size)

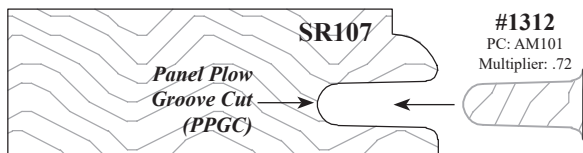

"GRF" Wood Filler Molding (Cut to Size)

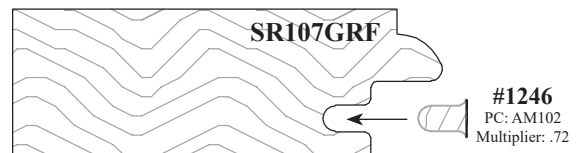

Molding #2933, #3041, #3042 - Wood Retainer Molding for True Lite Retainer Groove -TLRG (Cut to Size)

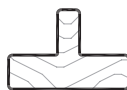
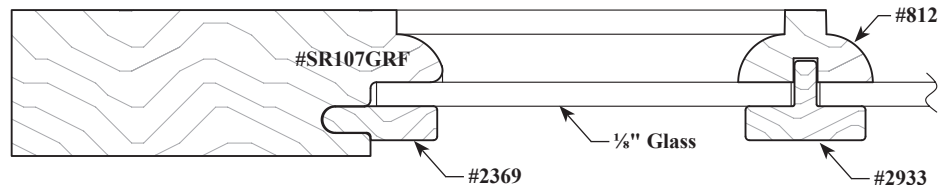

Mullion Molding Width	Wood Retainer Molding
1 5/32" [12.0mm] to 3 9/64" [15.8mm]	Molding #3042
5/8" [15.9mm] to 1 3/64" [26.9mm]	Molding #2933
1 1/16" [27.0mm] to 1 31/64" [38.0mm]	Molding #3041

► For PRICING ► See Section B.12 in our current Wholesale Pricing Catalog.

Ordering & Pricing Notes: Cut to Size Wood Retainer Molding

Ordering Guidelines

1	Order Forms	Please use <i>Door Order Form (E•Z Form #2)</i> .
<b>Pricing</b>		
1	Pricing	Please see <i>Section B.12</i> of our current <b>Wholesale Pricing Catalog</b> .

Technical Notes: Cut to Size Wood Retainer Molding

Miscellaneous

1	Silicone	<p>Ⓢ = WalzCraft recommends using clear silicone caulk in a small tube. The small capacity tube makes application easier than if using a large caulking gun.</p> <ul style="list-style-type: none"> <li>• Silicone caulk is adhesive enough to hold your molding or glass in place, but flexible enough to allow you to break the bond and peel away the silicone caulk in case the molding or glass needs to be replaced for any reason.</li> </ul> <p>When working with True Lites with Divider Molding (<i>see Mullion Lite Option 2</i>), WalzCraft recommends applying a continuous bead of silicone caulk around the perimeter of the glass.</p> <p>When using the True Lite Retainer Groove method (<i>see Mullion Lite Option 3</i>), WalzCraft recommends applying a small dab of silicone caulk approximately every six inches into the grooves before inserting the retainer molding.</p>
---	----------	--

Molding Options (Chapter N)

1	Cut to Size Wood Retainer Moldings	<p>Wood retainer molding, as shown on the previous page, can be cut to size by WalzCraft when ordered in conjunction with a frame only or frame &amp; mullion door.</p> <ul style="list-style-type: none"> <li>• Indicate your chosen wood retainer molding number in the <i>Special Instructions</i> column on the order form.</li> </ul> <p>Wood retainer molding can be used in place of rubber retainer in straight stile and rail parts.</p> <p>All GRF “Traditional” and “Mitered” stile and rail profiles will accept wood retainer moldings in frame price classes <b>101, 103, 108, 115, 117, 132, 301 and 303</b>.</p> <p>You may pin precision cut wood retainer molding in place to create a stationary panel for combination frame and panel doors. (<i>Rubber retainer can be used to install glass in the frame portion.</i>)</p> <p>See <i>Section N.9</i> for 8' lengths of wood retainer molding.</p>
2	#1036, #1120, #3094 Wood Retainer Molding	<p>Designed for use as a wood retainer molding that is fastened to the rear of the frame and can be trimmed to size. See <i>Wood Retainer Molding Compatibility</i> chart on our website: <b>Resources/Technical Information</b> for which molding to used based on glass thickness (1/8" or 1/4"), door thickness and panel plow groove cut placement (PPGC).</p> <p><b>Cut to Size:</b> When ordered cut to size, WalzCraft will cut molding to length, but <i>customer will be responsible for trimming/sanding molding to required thickness.</i></p>
3	#1246 GRF Wood Filler Molding	<p>The illustration shows an example of how this molding fits into the GRF groove of the stile and rail profile.</p> <p>Designed to fill the void for the GRF groove in the stiles and rails of frame and mullion doors.</p> <p>For use with 3/4" [19.3mm] or 1" [25.4mm] thick doors.</p>
4	#1312 Wood Tenon Filler Molding	<p>The illustration shows an example of how this molding fits into the mortise of the stile and rail profile.</p> <p>Designed to fill the mortise PPGC (Panel Plow Groove Cut) of any stile and rail profile for your custom frame requirements.</p> <p>For use with 3/4" [19.3mm] or 1" [25.4mm] thick doors.</p>
5	#1317, #1329, #2369, #2671, #2871 Wood Retainer Molding	<p>Fit into the GRF cut of the stile and rail profile and are designed to be used with 1/8" [3.2mm] materials.</p> <p><b>Cut to Size:</b> When ordered cut to size, WalzCraft will cut molding to length, and trim/sand molding flush to back of door where applicable.</p>
6	#2090 Wood Retainer Molding	<p>Designed for use as a wood retainer molding to accommodate 1/4" [6.4mm] material for use with 1" [25.4mm] thick frames.</p>
7	#2933, #3041, #3042 Wood Retainer Molding for True Lite Retainer Groove	<p>Designed to be used as a wood retainer molding for true divided mullion lites.</p> <p>Only available with the following mullion lite patterns: <b>LP001, LP108, LP109, LP110, LP118, LP128, LP131, LP146, LP147</b>.</p> <p>Please submit requests for this application to our Customer Support Team.</p>
8	#2671 Wood Retainer Molding	<p>Fit into the GRF cut of the stile and rail profile and is designed to be used with 1/8" [3.2mm] materials.</p> <p>Designed for use with:</p> <ul style="list-style-type: none"> <li>• Traditional stile &amp; rail GRF profiles: <b>SR123, SR145, SR146, SR157, SR160, SR163, SR167, SR169</b>.</li> <li>• Mitered stile &amp; rail GRF profile families: <b>MP628, MP661, MP662, MP680, MP690, MP696, MP6104</b>.</li> <li>• All traditional and mitered Old World stile &amp; rail GRF profiles from <i>Section E.3 and E.11</i>.</li> </ul>

Ⓢ = WalzCraft recommends using silicone caulk to secure the wood retainer molding and/or glass. Please see *Notes* for more information.

Cut-to-Size Wood Retainer Molding - END

► For PRICING ► See Section B.12 in our current Wholesale Pricing Catalog.

**Ordering & Pricing Notes: Frame & Mullion Doors**

**Ordering Guidelines**

1	Order Forms	Please use <i>Door Order Form (E•Z Form #2)</i> .
<b>Pricing</b>		
1	Pricing	Please see <i>Section B.12</i> of our current <b>Wholesale Pricing Catalog</b> .

**Technical Notes: Frame & Mullion Doors**

**Cabinet Door & Drawer Front Options (Chapter B)**

1	Door Styles	Most Door Styles are available as a Frame or Mullion Door.
		Frame or Mullion Door Styles that use Corner Blocks, require glass to be cut to their contour.
		Glass openings are routed to follow the contour of the shape for certain door styles. Lists of applicable door styles can be found in <i>Sections B.1, B.2, B.3 and B.4</i> .
		When ordering door Styles <b>2500, 2505, 2525, 3500, 3535, 7000, 7010, 7020, 7030, 7040 &amp; 7070</b> as mullions, we suggest that your lite pattern be no greater than 2 wide due to the shape of the rails; 3 or more lites in the width may require custom construction.

**Convex/Concave Options (Chapter D)**

1	Available Lite Patterns	The  indicates lite patterns that are available convex/concave. See <i>Chapter D</i> for more information.
---	-------------------------	---

**Functional Options (Chapter F)**

1	Hinge Boring	Hinge boring is available for Frame & Mullion doors. Please see <i>Section F.1</i> for additional hinge boring requirements, ordering instructions and compatibility.
---	--------------	---

**General Information (Chapter A)**

1	Ready to Assemble (RTA)	RTA is available as an option for frame only doors. Not available on doors with mullion lite patterns.
2	Shipping Mullion Lite Pattern Doors	<p>WalzCraft takes great pride producing our lite pattern (LP) doors. To ensure that they arrive to you in ideal condition, you will find your door(s) enclosed in a plastic bag. We're doing this in order to maintain the 6% - 8% moisture content present during the door(s) construction.</p> <ul style="list-style-type: none"> <li>• During transit from our plant in La Crosse, Wisconsin to your location, the wood is exposed to varying humidity conditions. When wood is exposed to higher and/or lower humidity, it will take on, or release moisture from the wood. This expansion and contraction of the wood is extremely hard on the very fragile mullions and joints. Also, due to the the small mullions having limited gluing surface, WalzCraft may use multiple methods to achieve the best connection to the door frame and each other.</li> <li>• To maintain the wood's ideal 6% - 8% moisture content, it must be held in a controlled environment of 32% - 38% relative humidity. To maintain this moisture content, we are now shipping our doors in enclosed plastic bags. We advise that the door(s) remain enclosed in the plastic bag until you are ready to finish and/or install into your client's home that is maintained at 32% to 38% relative humidity.</li> <li>• Lite pattern (LP) doors that are not maintained within a relative humidity of 32% - 38% can experience mullions that bow and/or have joints fail. Neither of these conditions will be considered for warranty replacement.</li> </ul>

**Material Options**

1	MDF Mullions for SolidTone® Finish	MDF mullions are recommended with the specific intent that they be painted.
		<p>When ordering any of the following mullion lite patterns, WalzCraft strongly recommends using MDF mullions for SolidTone® or Primed Only for Paint applications when the door frame is solid wood: <b>LP100, LP112, LP113, LP114, LP115, LP116, LP126, LP127, LP129, LP130, LP132, LP133, LP134, LP139, LP140, LP141, LP142, LP144, LP145, LP148, LP151, LP152, LP153, LP155.</b></p> <ul style="list-style-type: none"> <li>• MDF has lower rates of expansion and contraction than solid wood, and therefore is an excellent material for the fabrication of complex mullion lite patterns that are intended to be painted.</li> <li>• MDF lite patterns are designed and machined to have tight radius corners (<math>\frac{1}{16}</math>" radius) whenever possible.</li> <li>• When ordering MDF mullions for SolidTone® or Primed only for Paint applications, please order your door in any of the following Hybrid/MDF (or MDF-MR) species from the SolidTone® availability grids in <i>Section R.2</i>: <ul style="list-style-type: none"> <li>◦ Birch - Hybrid/MDF - Paint Grade</li> <li>◦ Cherry - Hybrid/MDF - Paint Grade</li> <li>◦ Maple-Hard - Hybrid/MDF - Natural/Standard Grade (recommended for best results)</li> <li>◦ Poplar - Hybrid/MDF - Paint Grade</li> </ul> </li> <li>• When painting cherry, no attempt will be made to conceal any of the naturally occurring characteristics that may be present, including but not limited to pin knots and gum pockets. Please note that if not sealed properly, gum pockets may bleed through your finish.</li> <li>• MDF lite pattern charges and set-up charges are priced less than solid wood. <ul style="list-style-type: none"> <li>◦ See <i>Section B.12</i> of our current <b>Wholesale Pricing Catalog</b>.</li> </ul> </li> <li>• Lite patterns not listed above would still be made from solid wood mullion stock only.</li> </ul>

► For PRICING ► See *Section B.12* in our current Wholesale Pricing Catalog.

Technical Notes: Frame & Mullion Doors...continued

Material Options...continued

2	Maple - Hard vs. Soft	For quality reasons, product requiring CNC machining will not be available in any Maple-Hard/Soft-Mixed species or Maple-Soft species. These items should instead be ordered in any of our Maple-Hard species. When specifying small moldings in Maple-Soft, WalzCraft reserves the right to substitute with Maple-Hard.
---	-----------------------	---

Miscellaneous

1	Standard /True Divided Lites	Mullion lite patterns are available with either standard or true divided lites, unless otherwise noted.
2	Custom Mullion Placement	Custom mullion placement is available. Please submit drawings to our Customer Support Team to request a quote.
3	Wood/Rubber Glass Retainer	See previous pages for our wood and rubber glass retainer options and applications.
4	Compatibility Charts	Please reference our website: <a href="#">Resources/Technical Information</a> .

Molding Options (Chapter N)

1	Applied Moldings on MDF	When an applied molding is added to an MDF product, the molding will be made from Maple-Hard/Soft Mixed-Value/Budget/Paint Grade.
---	-------------------------	---

Profile Options (Chapter E)

1	Stile & Rail Profiles	<b>Miter Profiles:</b> Please see the <b>Miter Compatibility</b> charts on our website: <a href="#">Resources/Technical Information</a> for lite pattern compatibility. <b>Traditional/Old World Profiles:</b> Please see the <b>Stile &amp; Rail Compatibility</b> charts on our website: <a href="#">Resources/Technical Information</a> for lite pattern compatibility.
2	Alternative Mullion Molding Required	The following mullion lite patterns require an alternative mullion molding be used with certain stile & rail profiles: <b>LP105, LP106, LP107, LP111, LP112, LP114, LP115, LP117, LP119, LP120, LP121, LP122, LP125, LP127, LP129, LP130, LP132, LP134, LP137, LP138, LP141, LP142, LP144, LP145, LP150, LP151, LP152, LP153.</b> <b>Section E.1:</b> SR103/#1268 uses #815, SR121/#1110 uses #2673, SR127/#1263 uses #2407. <b>Section E.3:</b> SR192/#1966 uses #2587, SR196/#1304 uses #2925, SR197/#1305 uses #2672, SR199/#1307 uses #2642. <b>Section E.5:</b> SR133/AM1717 - #1267 uses #2194, SR133/AM3053 - #2375 uses #3074. <b>Section E.9:</b> MP613/#1268 uses #815, MP626/#1110 uses #2673, MP637/#1263 uses #2407, MP668/#1260 uses #2957, MP675/#2375 uses #3074, MP685/#2495 uses #2494. <b>Section E.10:</b> MP735/#1164 uses #2557.

Sizes/Dimensions

1	Thicknesses	Some door styles (e.g., <b>Style 10</b> ) using frame only pricing are only available ¾" [19.3mm] and 1" [25.4mm] thick (i.e., when using Traditional profiles). Other door styles may also be available 1" [25.4mm], 1½" [28.6mm], and 1¼" [31.8mm] thick (i.e., when using Old World profiles). See individual door style sections and/or stile & rail profile sections for available thicknesses. See <b>Section S.3</b> for possible thickness restrictions based on wood species.
2	Center Rails	Frame and mullion doors over 48"H [1219.2mm] will <b>not</b> have a center rail unless specified by the customer. Any frame and/or mullion door over 48" [1219.2mm] high ordered <b>without</b> a center rail will carry no warranty. • See <b>Section A.8</b> for more information regarding our warranties on warping, bowing and twisting. Any mullion door over 60" [1524.0mm] high ordered <b>without</b> a center rail must be built with true divided lites to help maintain structural integrity.
3	Mullion Strips	For mullion strips over 28" [711.2mm] wide or high, WalzCraft recommends applying a small bead of silicone between the back of the mullion and the glass to help assure stability and prevent possible warpage.
4	Minimum Frame Width	Minimum width for a frame with a mullion lite pattern is 12" [304.8mm] unless noted otherwise. <i>Minimum is based on 2¼" [57.2mm] Stiles and Rails.</i>
5	Glass Size Calculations	For single or multiple opening frame only doors and single or multiple opening frame & mullion doors with standard lites, if wanting to order designer glass from WalzCraft with your door, WalzCraft will calculate glass size based on your door specifications. This applies to doors with straight stiles & rails resulting in rectangular shaped glass only. See <b>Section G.1</b> . For single opening frame only doors and single opening frame & mullion doors with standard lites, if wanting to order glass from a vendor other than WalzCraft before receiving the door, please refer to our glass size calculation formula earlier in this section. This applies to doors with straight stiles & rails resulting in rectangular shaped glass only. WalzCraft does <b>not</b> calculate glass size for frame & mullion doors with true divided lites or frame only doors with shaped stiles or rails. For these styles we recommend waiting until you receive your door, then take it to your local glass supplier to have your glass cut to fit each opening.

Frame & Mullion Doors - END

► For PRICING ► See Section B.12 in our current Wholesale Pricing Catalog.

Technical & Ordering Notes: Mullion Lite Patterns

Mullion Lite Pattern Guidelines

1	10MUL, 40MUL Flat Panel Door with Mullions	10MUL: Lite pattern is applied to the front face of an MDF RVSCP-PR324 reversed solid center panel.
		40MUL: Lite pattern is applied to the front face of a 1/4" [6.4mm] flat panel (veneered or raw MDF). A lite pattern must be specified for this style.
		Available with <b>most</b> Traditional profiles with matching mullion stock options.
2	LP001	All lites will be evenly spaced, unless otherwise noted.
		When ordering, please specify the number of lites and the lite pattern configuration (ie: 6 lites with a 2 x 3 pattern). Additional design charges may apply for customer specified lite pattern configurations or placement.
3	LP100, LP105, LP107, LP115, LP116, LP117, LP125, LP133, LP137, LP142, LP145	Minimum width for a frame with a Mullion Lite Pattern is 12" [304.8mm]. <i>Minimum is based on 2 1/4" [57.2mm] Stiles &amp; Rails.</i> Minimum height for LP116 and LP133 is 12" [304.8mm].
		Available with <b>most</b> Traditional GRF profiles with matching mullion stock options. Limitations apply to Mitered GRF profiles.
		Limitations apply to these mullion patterns and Applied Molding.
		LP100, LP115, LP116, LP133, LP142, LP145: See <b>Material Options</b> note for more information on MDF Mullions with a SolidTone® or Primed Only finish. <b>A CAD drawing must be approved, prior to manufacturing the products.</b>
4	LP101, LP102, LP103, LP104	Minimum Frame width for these Lite Patterns is 12" [304.8mm]. <i>Minimum is based on 2 1/4" [57.2mm] stiles, bottom rail, and top rail at the narrowest.</i>
		Available with <b>most</b> Traditional GRF profiles with matching mullion stock options. <b>Not available with Mitered</b> GRF Profiles.
		Limitations apply to these mullion patterns and Applied Molding.
5	LP105	Height must be equal to or greater than the width to allow one pattern or twice the width for a pattern on top & bottom. <i>Minimum is based on 2 1/4" [57.2mm] Stiles and Rails.</i>
6	LP106	Minimum Frame width for this Lite Pattern is 12" [304.8mm]. <i>Minimum is based on 2 1/4" [57.2mm] stiles, bottom rail &amp; top rail at the narrowest.</i>
		Specify the Width and Height of the corner lites. <i>Minimum size for corner lites is 2" x 2" [50.8mm x 50.8mm].</i>
		Available with <b>most</b> Traditional GRF profiles with matching mullion stock options. <b>Not available with Mitered</b> GRF Profiles. Limitations apply to this mullion pattern and Applied Molding.
7	LP108	Minimum width for a frame with a Mullion Lite Pattern is 12" [304.8mm]. <i>Minimum is based on 2 1/4" [57.2mm] Stiles and Rails.</i>
		Opening height of the lite pattern must be specified, <i>minimum height is 1" [25.4mm].</i> Width of the lite pattern will be equal.
		Short pieces will be half of the height of the vertical pieces above it and have a "female" cut on the ends.
		Available with all 3/4" [19.3mm] Traditional and 1" [25.4mm] Old World Stile and Rail Profile / Mullion Combinations; <i>See Profile Information.</i>
8	LP109	Opening height of the lite pattern must be specified, <i>minimum height is 1" [25.4mm].</i> Width of the lite pattern will be equal.
		Additional design charges may apply for customer specified lite pattern configurations or placements that vary from designs shown.
9	LP110	Minimum width for a frame with a Mullion Lite Pattern is 12" [304.8mm]. <i>Minimum is based on 2 1/4" [57.2mm] Stiles and Rails.</i>
		Available with <b>most</b> Traditional GRF profiles with matching mullion stock options.
		Pattern consists of two center lites with 1" [25.4mm] spacing; the remaining space is equally divided to the outside.

Continued on next page...

► For PRICING ► See Section B.12 in our current Wholesale Pricing Catalog.

Technical & Ordering Notes: Mullion Lite Patterns...continued

Mullion Lite Pattern Guidelines...continued

10	LP111	Minimum width for a frame with a Mullion Lite Pattern is 12" [304.8mm]. <i>Minimum is based on 2 1/4" [57.2mm] Stiles and Rails.</i>
		One Pattern (4 Lites): Minimum door height must be 1.5 times the door width, plus the total width of the top / bottom rail.
		Two Patterns (7 Lites): Minimum door height must be 2 times the door width, plus the total width of the top / bottom rail.
		Available with <b>most</b> Traditional GRF profiles with matching mullion stock options. Limitations apply to Mitered GRF profiles.
		Limitations apply to these mullion patterns and Applied Molding. <b>A CAD drawing must be approved, prior to manufacturing the product.</b>
11	LP112, LP130, LP132, LP138, LP152, LP153	Minimum width for a frame with a Mullion Lite Pattern is 12" [304.8mm]. <i>Minimum is based on 2 1/4" [57.2mm] Stiles and Rails.</i>
		In order to achieve the best look, the height of door must be at least two times the width of door.
		Available with <b>most</b> Traditional GRF profiles with matching mullion stock options. Limitations apply to Mitered GRF profiles.
		Limitations apply to this mullion pattern and Applied Molding. <b>LP112, LP130, LP132, LP152, LP153:</b> See <b>Material Options</b> note for more information on MDF Mullions with a Solid-Tone® or Primed Only finish.
		<b>A CAD drawing must be approved, prior to manufacturing the product.</b>
12	LP113	Minimum width for a frame with a Mullion Lite Pattern is 12" [304.8mm]. <i>Minimum is based on 2 1/4" [57.2mm] Stiles &amp; Rails.</i>
		Vertical mullion strip at top and horizontal mullion strips are fixed at 1" long. For LP113 (2) Pattern, the vertical mullion strip at bottom is also fixed at 1" long.
		Minimum height of door must be equal to or greater than the width. For LP113 (2) Pattern, the minimum height must be at least 1 1/4 times the width.
		Available with <b>most</b> Traditional GRF profiles with matching mullion stock options. Limitations apply to Mitered GRF profiles.
		Limitations apply to these mullion patterns and Applied Molding.
		See <b>Material Options</b> note for more information on MDF Mullions with a SolidTone® or Primed Only finish. <b>A CAD drawing must be approved, prior to manufacturing the products.</b>
13	LP114, LP134	Minimum width for a frame with a Mullion Lite Pattern is 12" [304.8mm]. <i>Minimum is based on 2 1/4" [57.2mm] Stiles and Rails.</i>
		Minimum height needs to be at least 1 1/2 times the width of the door.
		Available with <b>most</b> Traditional GRF profiles with matching mullion stock options. Limitations apply to Mitered GRF profiles.
		Limitations apply to this mullion pattern and Applied Molding.
		See <b>Material Options</b> note for more information on MDF Mullions with a SolidTone® or Primed Only finish. <b>A CAD drawing must be approved, prior to manufacturing the product.</b>
14	LP118	Specify the Width and Height of the corner lites. <i>Minimum size for corner lites is 1" x 1" [25.4mm x 25.4mm].</i>
		Additional design charges may apply for customer specified lite pattern configurations or placements.
15	LP119, LP120, LP121, LP122	Minimum width for a frame with a Mullion Lite Pattern is 12" [304.8mm]. <i>Minimum is based on 2 1/4" [57.2mm] Stiles and Rails.</i>
		Corner lites must be specified at the widest & narrowest: this determines the radius of the curved piece. <i>Minimum at narrowest is 2" [50.8mm].</i>
		Available with <b>most</b> Traditional GRF profiles with matching mullion stock options. Limitations apply to Mitered GRF profiles.
		Limitations apply to these mullion patterns and Applied Molding.

Continued on next page...

► For PRICING ► See Section B.12 in our current Wholesale Pricing Catalog.

Technical & Ordering Notes: Mullion Lite Patterns...continued

Mullion Lite Pattern Guidelines...continued

16	LP123	Due to complexity, width dimensions for this Lite Pattern are <i>limited to fixed sizes</i> . Doors are available from 12" to 24" wide in 1" increments. Heights may vary.
		Width dimensions are based on 2¼" [57.2mm] stiles.
		Constructed with Stile & Rail Profile <b>SR100</b> , Applied Molding <b>#101</b> or <b>#102 (Section N.5)</b> and Mullion Stock Molding <b>#1895 (Section N.6)</b> .
		<b>Style 3020 / LP123</b> is only available with the following Outside Edge profiles: <b>D7, D12, D15, D17, D18, D21, D24, D32, D41, D52, D67, D93, D101, D102, D115, D118, D120</b> . • There are no Outside Edge profile limitations with <b>Style 3022 / LP123</b> .
		When ordering sizes that range between one or two templates, the frame must be constructed with non-standard part sizes to maintain the mullion pattern template size. You may increase the size of the stiles on the frame, or decrease the size of the stiles on the frame. <i>If ordering a mullion door 12½" [317.5mm] wide, you will need 2½" [63.5mm] stiles.</i> The top and bottom rails may also be increased by the same value to maintain aesthetics and balance proportions.
		<b>A CAD drawing must be approved, prior to manufacturing the product.</b>
17	LP124	Minimum width for a frame with a Mullion Lite Pattern is 12" [304.8mm]. <i>Minimum is based on 2¼" [57.2mm] Stiles and Rails.</i>
		Specify the Width and Height of the corner lites. <i>Minimum size for corner lites is 1" x 1" [25.4mm x 25.4mm].</i>
		Limitations apply to Mitered GRF profiles.
		Limitations apply to these mullion patterns and Applied Molding.
		<b>A CAD drawing must be approved, prior to manufacturing the product.</b>
18	LP126	Minimum width for a frame with a Mullion Lite Pattern is 12" [304.8mm]. <i>Minimum is based on 2¼" [57.2mm] Stiles and Rails.</i>
		Width of diamond portion will be approximately one third the size of opening width, with a minimum of 2" x 2" [50.8mm x 50.8mm] square.
		Height must be <b>at least</b> two times the width of the door.
		Available with <b>most</b> Traditional GRF profiles with matching mullion stock options.
		Limitations apply to Mitered GRF profiles.
		Limitations apply to these mullion patterns and Applied Molding.
		See <b>Material Options</b> note for more information on MDF Mullions with a SolidTone® or Primed Only finish.
		<b>A CAD drawing must be approved, prior to manufacturing the product.</b>
19	LP127	Minimum width for a frame with a Mullion Lite Pattern is 12" [304.8mm]. <i>Minimum is based on 2¼" [57.2mm] Stiles and Rails.</i>
		For LP127 - 4 Lites, minimum height of the door must be greater than the width.
		For LP127 - (2) Patterns - 7 Lites, minimum height must be at least 2 times the width of the door.
		Available with <b>most</b> Traditional GRF profiles with matching mullion stock options.
		Limitations apply to Mitered GRF profiles.
		Limitations apply to this mullion pattern & Applied Molding.
		See <b>Material Options</b> note for more information on MDF Mullions with a SolidTone® or Primed Only finish.
		<b>A CAD drawing must be approved, prior to manufacturing the product.</b>
20	LP128	Minimum width for a frame with a Mullion Lite Pattern is 12" [304.8mm]. <i>Minimum is based on 2¼" [57.2mm] Stiles &amp; Rails.</i>
		Opening height of top & bottom lites must be specified, minimum of 1". Width of top & bottom lites will be equal.
		Width of center lite pattern will consist of two center lites with 1" [25.4mm] spacing. The remaining space on either side will be equally divided.
		Available with <b>most</b> Traditional GRF profiles with matching mullion stock options. Limitations apply to Mitered GRF profiles.
		Limitations apply to this mullion pattern and Applied Molding.

Continued on next page...

► For PRICING ► See Section **B.12** in our current Wholesale Pricing Catalog.

Technical & Ordering Notes: Mullion Lite Patterns...continued

Mullion Lite Pattern Guidelines...continued

21	LP129	Minimum width for a frame with a Mullion Lite Pattern is 12" [304.8mm]. <i>Minimum is based on 2 1/4" [57.2mm] Stiles and Rails.</i>
		Minimum height of door must be equal to or greater than the width.
		Available with <b>most</b> Traditional GRF profiles with matching mullion stock options. Limitations apply to Mitered GRF profiles.
		Limitations apply to this mullion pattern and Applied Molding.
		See <b>Material Options</b> note for more information on MDF Mullions with a SolidTone® or Primed Only finish. <b>A CAD drawing must be approved, prior to manufacturing the product.</b>
22	LP131	Minimum width for a frame with a Mullion Lite Pattern is 12" [304.8mm]. <i>Minimum is based on 2 1/4" [57.2mm] Stiles and Rails.</i>
		Opening height of top & bottom lites must be specified, minimum of 1" [25.4mm]. Width of top & bottom lites will be equal.
		Width of center lite pattern will consist of two center lites with 1" [25.4mm] spacing. The remaining space on either side will be equally divided.
		Available with <b>most</b> Traditional GRF profiles with matching mullion stock options. Limitations apply to Mitered GRF profiles. Limitations apply to this mullion pattern and Applied Molding.
23	LP136	Minimum size for a frame with this mullion lite pattern is 12"W x 19"H [304.8mm x 482.6mm]. <i>Minimum is based on 2 1/4" [57.2mm] Stiles and Rails.</i>
		Horizontal mullion will be centered on opening height. Width of center consists of two 5/8" [15.9mm] wide lites with the remaining space on either side being equally divided.
		Mullions are 5/8" [15.9mm] wide with the top left/right vertical mullions widening to 15/16" [23.8mm].
		Only available with the SR100GRF and SR123GRF stile & rail profiles. <b>A CAD drawing must be approved, prior to manufacturing the product.</b>
24	LP139	Minimum width for a frame with a Mullion Lite Pattern is 12" [304.8mm]. <i>Minimum is based on 2 1/4" [57.2mm] Stiles and Rails.</i>
		Minimum door height needs to be at least the width of the door plus the width of the bottom rail.
		Square portion is a fixed size with a 2 1/2" x 2 1/2" [63.5mm x 63.5mm] opening.
		Drawing shows the horizontal mullion strip dividing the opening at an approximate 30/70 ratio. See <b>Material Options</b> note for more information on MDF Mullions with a SolidTone® or Primed Only finish.
25	LP140	Minimum width for a frame with a Mullion Lite Pattern is 12" [304.8mm]. <i>Minimum is based on 2 1/4" [57.2mm] Stiles and Rails.</i>
		Minimum height of door must be at least two times the width of door.
		Available with <b>most</b> Traditional GRF profiles with matching mullion stock options. Limitations apply to Mitered GRF profiles.
		Limitations apply to this mullion pattern and Applied Molding.
		See <b>Material Options</b> note for more information on MDF Mullions with a SolidTone® or Primed Only finish. <b>A CAD drawing must be approved, prior to manufacturing the product.</b>
26	LP141	Corner lites are a fixed size with 2" x 2" [50.8mm x 50.8mm] openings.
		Minimum width for a frame with a Mullion Lite Pattern is 12" [304.8mm]. <i>Minimum is based on 2 1/4" [57.2mm] Stiles and Rails.</i>
		Minimum height of the door must be at least 1 1/2 times the width.
		Available with <b>most</b> Traditional GRF profiles with matching mullion stock options.
		Limitations apply to Mitered GRF profiles.
		Limitations apply to this mullion pattern & Applied Molding. See <b>Material Options</b> note for more information on MDF Mullions with a SolidTone® or Primed Only finish. <b>A CAD drawing must be approved, prior to manufacturing the product.</b>

Continued on next page...

► For PRICING ► See Section B.12 in our current Wholesale Pricing Catalog.

Technical & Ordering Notes: Mullion Lite Patterns...continued

Mullion Lite Pattern Guidelines...continued

27	LP143	Minimum width for a frame with a Mullion Lite Pattern is 12" [304.8mm]. <i>Minimum is based on 2¼" [57.2mm] Stiles and Rails.</i>
		Specify the width and height of the corner lites. <i>Minimum size for corner lites is 1" x 1" [25.4mm x 25.4mm].</i>
		Specify height of full width horizontal lites.
		Width of center lites will match width of lites at top and bottom.
		Additional design charges may apply for customer specified lite pattern configurations or placements.
28	LP144	Minimum width for a frame with a Mullion Lite Pattern is 12" [304.8mm]. <i>Minimum is based on 2¼" [57.2mm] Stiles and Rails.</i>
		Minimum height needs to be at least 1¾ times the width of the door.
		Available with <b>most</b> Traditional GRF profiles with matching mullion stock options. Limitations apply to Mitered GRF profiles.
		Limitations apply to this mullion pattern and Applied Molding.
		See <b>Material Options</b> note for more information on MDF Mullions with a SolidTone® or Primed Only finish. <b>A CAD drawing must be approved, prior to manufacturing the product.</b>
29	LP148	Minimum width for a frame with a mullion lite pattern is 12" [304.8mm]. <i>Minimum is based on 2¼" [57.2mm] Stiles and Rails.</i>
		Horizontal mullion strips are fixed at 1" long.
		Minimum height of door must be equal to or greater than the width.
		See <b>Material Options</b> note for more information on MDF Mullions with a SolidTone® or Primed Only finish.
		<b>A CAD drawing must be approved, prior to manufacturing the product.</b>
30	LP149	Minimum width for a frame with a Mullion Lite Pattern is 12" [304.8mm]. <i>Minimum is based on 2¼" [57.2mm] Stiles and Rails.</i>
		Height of door must be greater than the width.
		Available with <b>most</b> Traditional GRF profiles with matching mullion stock options. Limitations apply to Mitered GRF profiles.
		Limitations apply to this mullion pattern and applied molding.
		<b>A CAD drawing must be approved, prior to manufacturing the product.</b>
31	LP150	Minimum width for a frame with a Mullion Lite Pattern is 12" [304.8mm]. <i>Minimum is based on 2¼" [57.2mm] Stiles and Rails.</i>
		Available with <b>most</b> Traditional GRF profiles with matching mullion stock options. Limitations apply to Mitered GRF profiles.
		Limitations apply to this mullion pattern and Applied Molding.
		<b>A CAD drawing must be approved, prior to manufacturing the product.</b>
32	LP151	Minimum width for a frame with a Mullion Lite Pattern is 12" [304.8mm]. <i>Minimum is based on 2¼" [57.2mm] Stiles and Rails.</i>
		In order to achieve the best look, the height of door must be at least two times the width of the door.
		Available with <b>most</b> Traditional GRF profiles with matching mullion stock options. Limitations apply to Mitered GRF profiles.
		Limitations apply to this mullion pattern & Applied Molding.
		See <b>Material Options</b> note for more information on MDF Mullions with a SolidTone® or Primed Only finish.
		<b>A CAD drawing must be approved, prior to manufacturing the product.</b>
33	LP154	Specify the Width and Height of the corner lites. <i>Minimum size for corner lites is 1" x 1" [25.4mm x 25.4mm].</i>
		Height of center lites will match the specified height of corner lites.
		Additional design charges may apply for customer specified lite pattern configurations or placements.

Continued on next page...

**Technical & Ordering Notes: Mullion Lite Patterns...continued**

**Mullion Lite Pattern Guidelines...continued**

34	LP155	Minimum size for a frame with this mullion lite pattern is 10"W x 18"H [254.0mm x 457.2mm]. Minimum is based on 2¼" [57.2mm] wide stiles and rails.
		Specify length of vertical mullion strips and horizontal mullion strips. Minimum length of 1½" [38.1mm].
		Specify size of squares/rectangles. Minimum size of 2½" x 2½" [63.5mm x 63.5mm].
		Available with <i>most</i> Traditional GRF profiles with matching mullion stock options. Limitations apply to Mitered GRF profiles.
		Limitations apply to this mullion pattern and applied moldings.
		See <i>Material Options</i> note for more information on MDF mullions with SolidTone® or Primed Only for Paint finishes.
		<b>A CAD drawing must be approved prior to manufacturing the product.</b>

**Mullion Lite Pattern Guidelines - END**

Combination Frame-Only & Panel Door Styles

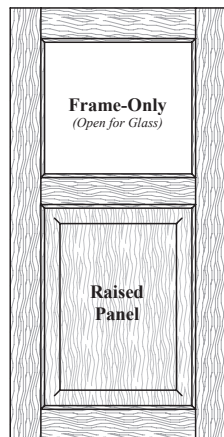

Style: 1616  
PC: 103

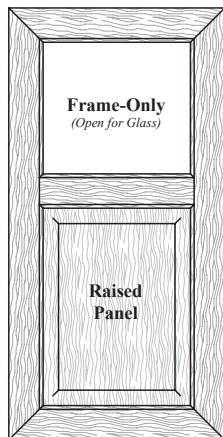

Style: 1616M  
PC: 303

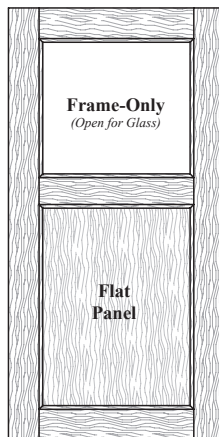

Style: 4016  
PC: 203

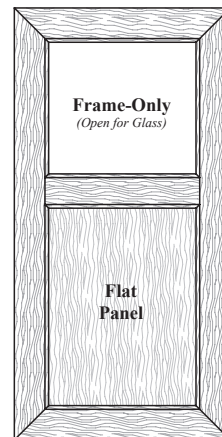

Style: 4016M  
PC: 403

Ordering & Pricing Notes: Combination Frame & Panel Doors

Ordering Guidelines

1	Order Forms	Please use <i>Door Order Form (E•Z Form #2)</i> .
2	Ordering Guidelines	<p>Specify the:</p> <ul style="list-style-type: none"> <li>• Location of frame-only section (top or bottom).                             <ul style="list-style-type: none"> <li>◦ Remaining section will be either a raised panel or a flat panel depending on style chosen.</li> <li>◦ Please provide center panel profile if ordering <b>Style 1616</b> or <b>Style 1616M</b>.</li> </ul> </li> <li>• When applicable, please also indicate the mullion lite pattern (<i>Section B.12</i>) or slat/dowel pattern (<i>Section G.6</i>).</li> <li>• Center rail placement (distance from top of door to top of center rail).</li> </ul>

Pricing

1	Pricing	Please see <i>Section B.13</i> of our current Wholesale Pricing Catalog.
---	---------	--

Technical Notes: Combination Frame & Panel Doors

Cabinet Door & Drawer Front Options (Chapter B)

1	Mullion Lite Patterns	The frame-only section is available with a mullion lite pattern. See <i>Section B.12</i> for more information.
2	French Miter Construction	Door styles <b>1616M</b> and <b>4016M</b> are also available with French Miter construction ( <i>Section B.7</i> ). Simply add an "FM" to the style number (ie: <b>Style 1616FM</b> ).
3	Style 1616 and 4016	These door styles are available with shaped rails. Please submit these requests to our Customer Support Team. A quote will be provided, as additional charges may apply.

Design Options (Chapter G)

1	Slats & Dowels	The frame-only section is available with slats or dowels. See <i>Section G.6</i> for more information.
---	----------------	--

Functional Options (Chapter F)

1	Hinge Boring	Hinge boring is available for Combination Frame & Panel doors. Please see <i>Section F.1</i> for additional hinge boring requirements, ordering instructions and compatibility.
---	--------------	---

General Information (Chapter A)

1	Ready to Assemble (RTA)	RTA is not available as an option.
---	-------------------------	------------------------------------

Material Options

1	Center Panel	These doors can be ordered with raised or reversed center panels in solid wood & raw MDF or with flat center panels in 1/4" [6.4mm] wood veneer & 1/4" [6.4mm] raw MDF.
---	--------------	---

Continued on next page...

► For PRICING ► See *Section B.13* in our current Wholesale Pricing Catalog.

**Technical Notes: Combination Frame & Panel Doors**

**Profile Options (Chapter E)**

1	Style 1616, 4016	Any Traditional or Old World stile and rail profile can be used ( <i>Sections E.1, E.2, E.3</i> ). • Some profiles <b>may not</b> be compatible for use with mullions or lite pattern options.
2	Style 1616M, 4016M	Any Mitered stile and rail profile can be used ( <i>Sections E.9, E.10, E.11</i> ). • Some profiles <b>may not</b> be compatible for use with mullions or lite pattern options.
7	French Miter Profiles	French Mitered doors are available with many of our <b>MP600/MP6000</b> Series Mitered Profiles. Please see <i>Section E.9</i> . Any <b>MP600/MP6000</b> series profile number that has a corresponding <b>[FM]</b> symbol is available for a French Miter door.
8	SR167	Not compatible with combination frame & panel door construction.

**Sizes/Dimensions**

1	Thicknesses	Combination Frame & Panel doors are available ¾" [19.3mm] and 1" [25.4mm] thick. See <i>Section S.3</i> for possible thickness restrictions based on wood species.
---	-------------	---

**Combination Frame & Panel Doors - END**

► For PRICING ► See Section **B.13** in our current Wholesale Pricing Catalog.

Operable/Adjustable Louvers (Accommodates Air Flow and/or Light Penetration Flexibility) - Interior Use Only

2" Operable Louver Construction Shown

See Notes



Louver Actuator & Mouse Hole

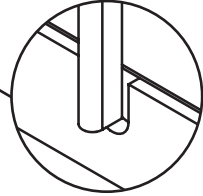

50/50 Split Shown

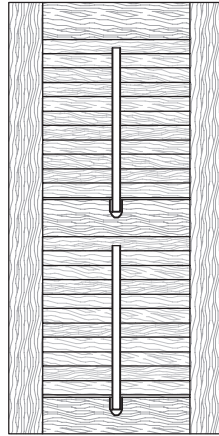

**Style: 8000**  
Full Louver  
Frame: PC103 x 0.6  
Min. Size: See Notes

50/50 Split Shown

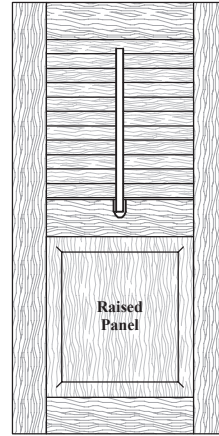

**Style: 8000**  
Louver Top-RP Bottom  
PC: 103  
Min. Size: See Notes

50/50 Split Shown

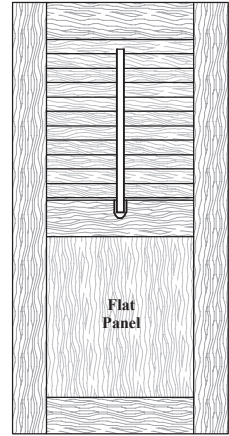

**Style: 4044**  
Louver Top-FP Bottom  
PC: 203  
Min. Size: See Notes

60/40 Split Shown

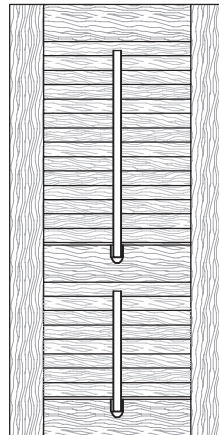

**Style: 1000**  
Full Louver  
Frame: PC103 x 0.6  
Min. Size: See Notes

60/40 Split Shown

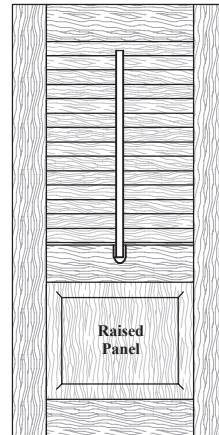

**Style: 1000**  
Louver Top-RP Bottom  
PC: 103  
Min. Size: See Notes

60/40 Split Shown

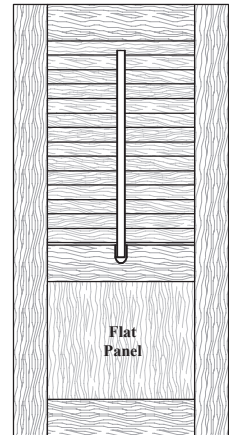

**Style: 4043**  
Louver Top-FP Bottom  
PC: 203  
Min. Size: See Notes

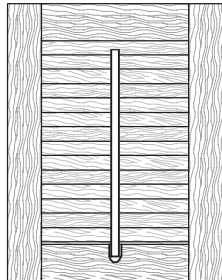

**Style: 10**  
Full Louver  
Frame: PC101 x 0.6  
Min. Size: See Notes

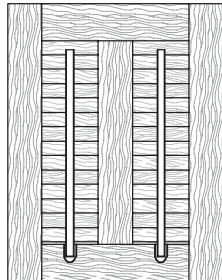

**Style: 1010**  
Full Louver  
Frame: PC103 x 0.6  
Min. Size: See Notes

**Operable Slat Moldings**

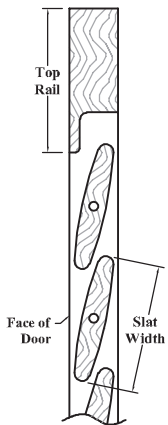

1" [25.4mm] Molding



**#2188**  
PC: M101  
Sq Ft: .72

1½" [38.1mm] Molding



**#2189**  
PC: M101  
Sq Ft: 1.00

2" [50.8mm] Molding



**#2190**  
PC: M101  
Sq Ft: 1.33

2½" [63.5mm] Molding



**#2239**  
PC: M101  
Sq Ft: 1.67

► For PRICING ► See Section B.14 in our current Wholesale Pricing Catalog.



Non-Operable (Fixed) Louvers (Accommodates Air Flow and Light Penetration - No Adjustability) - Interior Use Only

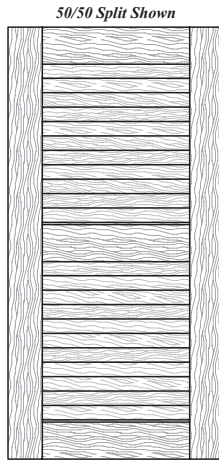
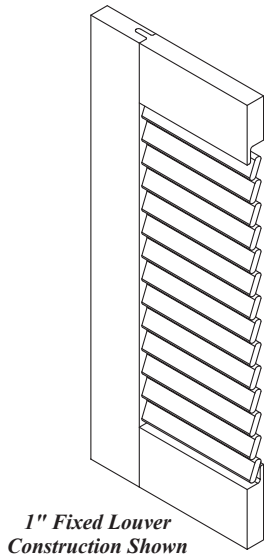

**Style: 8000**  
Full Louver  
Frame: PC103 x 0.6  
Min. Size: See Notes

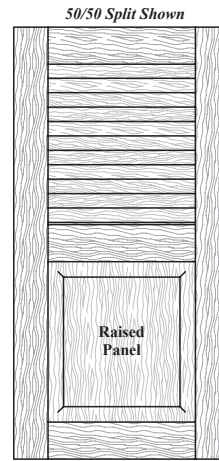

**Style: 8000**  
Louver Top-RP Bottom  
PC: 103  
Min. Size: See Notes

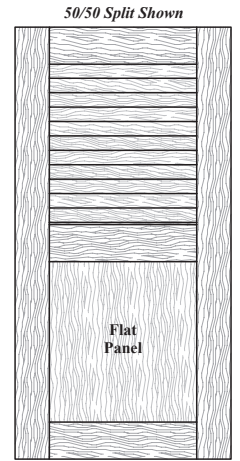

**Style: 4044**  
Louver Top-FP Bottom  
PC: 203  
Min. Size: See Notes

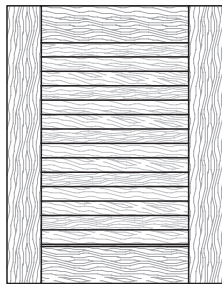

**Style: 10**  
Full Louver  
Frame: PC101 x 0.6  
Min. Size: See Notes

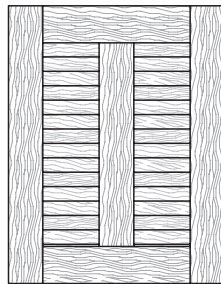

**Style: 1010**  
Full Louver  
Frame: PC103 x 0.6  
Min. Size: See Notes

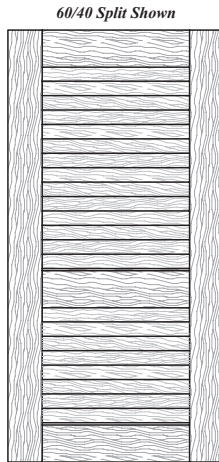

**Style: 1000**  
Full Louver  
Frame: PC103 x 0.6  
Min. Size: See Notes

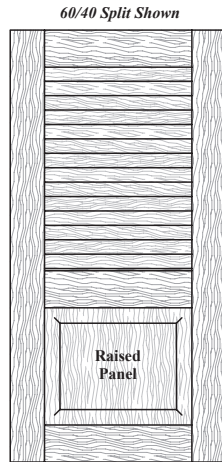

**Style: 1000**  
Louver Top-RP Bottom  
PC: 103  
Min. Size: See Notes

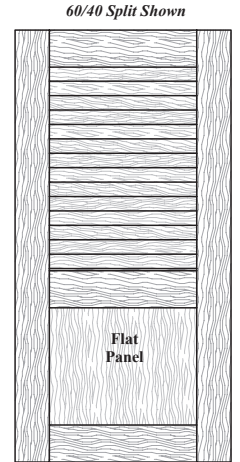

**Style: 4043**  
Louver Top-FP Bottom  
PC: 203  
Min. Size: See Notes

Non-Operable Slat Moldings

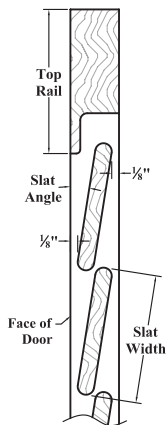

**1" [25.4mm] Molding**

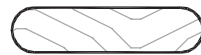

**#1051**  
PC: M102  
Sq Ft: .72

**1 1/4" [31.8mm] Molding**



**#2436**  
PC: M102  
Sq Ft: .83

**1 1/2" [38.1mm] Molding**



**#1245**  
PC: M102  
Sq Ft: 1.00

**2" [50.8mm] Molding**



**#1282**  
PC: M102  
Sq Ft: 1.33

**2 1/2" [63.5mm] Molding**

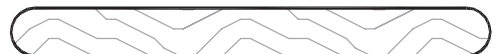

**#2238**  
PC: M102  
Sq Ft: 1.67

► For PRICING ► See Section B.14 in our current Wholesale Pricing Catalog.

**Ordering & Pricing Notes: Louvered Doors/Wood Shutters - Operable & Non-Operable (Fixed)**

**Ordering Guidelines**

<b>1</b>	<b>Order Forms</b>	Please use <i>Door Order Form (E•Z Form #2)</i> .
<b>2</b>	<b>Ordering Information</b>	Make sure to include the following information with your order: <ul style="list-style-type: none"> <li>• Operable or Non-Operable louvers.</li> <li>• Louver molding number.</li> <li>• Louver wood species /grade.</li> </ul> Reference notes below for additional information regarding louvered door specifications.
<b>Pricing</b>		
<b>1</b>	<b>Pricing</b>	Please see <i>Section B.14</i> of our current <b>Wholesale Pricing Catalog</b> .

**Technical Notes: Louvered Doors/Wood Shutters - Operable & Non-Operable (Fixed)**

**Cabinet Door & Drawer Front Options (Chapter B)**

<b>1</b>	<b>Door Styles</b>	Available for door styles in frame price classes <b>PC101</b> and <b>PC103</b> .
<b>2</b>	<b>Double Panel Doors</b>	Please specify which section you prefer to have the louvers installed in. They are available in the top section, bottom section or both, and can be ordered with a 50/50 or 60/40 split. If you prefer a custom center rail placement, please specify the dimension from the top of the door to the top of the center rail.
<b>3</b>	<b>60/40 Split</b>	If you plan to align louvered 60/40 split doors with non-louvered 60/40 split doors, center rail placement on the doors could vary due to louver size and placement, please specify a custom center rail placement, <i>see above note</i> .

**Finish Options (Chapter R)**

<b>1</b>	<b>Louver Actuator</b>	When ordering operable louver doors, the louver actuator is attached to the louvers with small metal eyelets. WalzCraft recommends removing these prior to finishing the doors, then reinstalling them once complete.
----------	------------------------	---

**Functional Options (Chapter F)**

<b>1</b>	<b>Hinge Boring</b>	Hinge boring is available for Louvered Doors/Wood Shutters - Operable & Non-Operable (Fixed). Please see <i>Section F.1</i> for additional hinge boring requirements, ordering instructions and compatibility. Operable & Non-Operable (Fixed) Louver doors ordered with hinge boring have a minimum stile & rail width of 2" [50.8mm].
----------	---------------------	--

**General Information (Chapter A)**

<b>1</b>	<b>Interior Use Only</b>	WalzCraft's Louvered Doors/Wood Shutters are intended for interior use only.
<b>2</b>	<b>Ready to Assemble (RTA)</b>	RTA is not available as an option.

**Material Options**

<b>1</b>	<b>Availability</b>	Operable & Non-Operable Louver doors are only available in solid wood and hybrid/MDF (solid wood stiles & rails with MDF center panels). <ul style="list-style-type: none"> <li>• Not available with MDF stiles/rails or louvers.</li> </ul>
----------	---------------------	--

**Miscellaneous**

<b>1</b>	<b>Air Flow/Light</b>	Operable/Adjustable Louver doors accommodate air flow and/or light penetration flexibility. Non-Operable (Fixed) Louver doors accommodate air flow and light penetration (no adjustability).
----------	-----------------------	---

**Profile Options (Chapter E)**

<b>1</b>	<b>Stile &amp; Rail Profile</b>	Only available with the <b>SR100-NPC</b> stile and rail profile when using Traditional construction. Only available with the <b>SR195-NPC</b> stile and rail profile when using Old World construction.
----------	---------------------------------	--

*Continued on next page...*

► **For PRICING** ► See *Section B.14* in our current Wholesale Pricing Catalog.

**Technical Notes: Louvered Doors/Wood Shutters - Operable & Non-Operable (Fixed)...continued**

**Sizes/Dimensions**

1	<b>Thickness Options</b>	Available ¾" [19.3mm], 1" [25.4mm], 1½" [28.6mm], 1¼" [31.8mm] thick. • See <b>Section S.3</b> for possible thickness restrictions based on wood species. • Please submit requests for other thicknesses to our Customer Support team.
2	<b>Louver Setbacks</b>	For non-operable louver doors, the louver setback varies with the door thickness and construction type. • ¾" thick Traditional construction: Setback = ⅛" [3.0mm] from face of door. • 1" thick Traditional construction: Setback = ⅛" [3.0mm] from face of door. • 1" thick Old World construction: Setback = ¼" [6.0mm] from face of door. • 1½" thick Old World construction: Setback = ¼" [6.0mm] from face of door. • 1¼" thick Old World construction: Setback = ¼" [6.0mm] from face of door.  For operable louver doors, the center of the louver will be positioned at the center of the door thickness.
3	<b>Maximum Door Height</b>	Maximum height for open louvered doors (operable and non-operable) is 96" [2438.4mm].
4	<b>Minimum Door Sizes</b>	Please reference the <b>Louver Door Minimum Sizes</b> compatibility chart on our website under: <b>Resources/Technical Information</b> . This chart will give you the minimum sizes for Operable, Non-Operable and Fixed Louver door styles based on louver size.
5	<b>Minimum Stile &amp; Rail Widths</b>	Minimum width for top and bottom rails is 1¼".
		Minimum width for left and right stiles is 2".
		Minimum width for center stiles and center rails is 2¼".
6	<b>Non-Standard Parts</b>	The top, bottom and center rails may need to be adjusted in size to accommodate full louver placement within an opening. Non-Standard part size charges will apply.
7	<b>Open Louvers Spacing</b>	Spacing from louver to louver is ½" (2.5mm).
		The spacing at the top and bottom varies with the size of the louver.
8	<b>Operable Louvers Spacing</b>	Due to the movement of the louvers, the spacing between louvers will be fixed.
9	<b>Fixed Louver Stabilizer</b>	Non-Operable (Fixed) Louvered doors with an opening width of 16" [406.4mm] or greater will receive a fixed louver stabilizer that attaches to the back of the louvers and door rails. Additional charges will apply.
10	<b>Doors - 36" [914.4mm] Wide</b>	Operable and Non-Operable (Fixed) Louvered doors 36" [914.4mm] and wider require a center stile, <b>see Style 1010</b> on previous page.
11	<b>Louvered Slats Sizes</b>	Non-Operable (Fixed) Louvered slats available in 1" [25.4mm], 1¼" [31.8mm], 1½" [38.1mm], 2" [50.8mm], and 2½" [63.5mm] widths. See <b>Section N.9</b> for 8' moldings.
		Operable Louvered slats available in 1" [25.4mm], 1½" [38.1mm], 2" [50.8mm] and 2½" [63.5mm] widths. See <b>Section N.9</b> for 8' moldings.

**Louvered Doors/Wood Shutters - Operable & Non-Operable (Fixed) - END**

► For PRICING ► See Section **B.14** in our current Wholesale Pricing Catalog.

*Closed Louvers (Does Not Accommodate Air Flow or Light Penetration) - Interior Use Only*

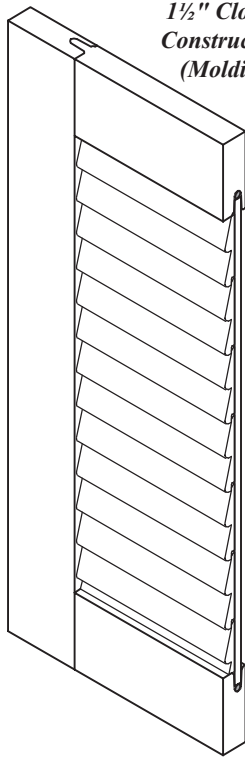

*1/2" Closed Louver  
Construction Shown  
(Molding #1187)*



**Style: 4044**  
Full Louver  
PC: 203  
Min. Size: *See Notes*

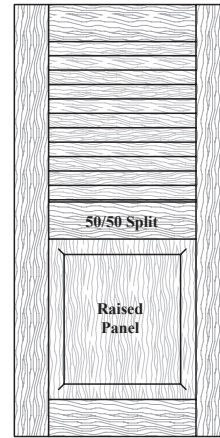

**Style: 8000**  
Louver Top-RP Bottom  
PC: 103  
Min. Size: *See Notes*

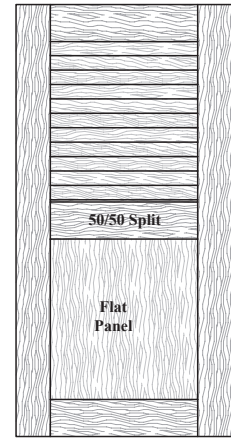

**Style: 4044**  
Louver Top-FP Bottom  
PC: 203  
Min. Size: *See Notes*

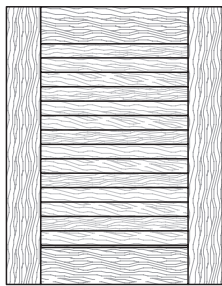

**Style: 40**  
Full Louver  
PC: 201  
Min. Size: *See Notes*

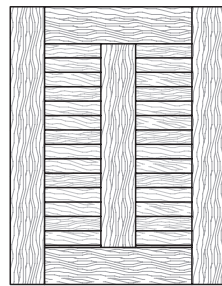

**Style: 4040**  
Full Louver  
PC: 203  
Min. Size: *See Notes*



**Style: 4043**  
Full Louver  
PC: 203  
Min. Size: *See Notes*



**Style: 1000**  
Louver Top-RP Bottom  
PC: 103  
Min. Size: *See Notes*



**Style: 4043**  
Louver Top-FP Bottom  
PC: 203  
Min. Size: *See Notes*

► **For PRICING** ► See Section **B.15** in our current Wholesale Pricing Catalog.

Slat Applied Molding Options - Interior Use Only

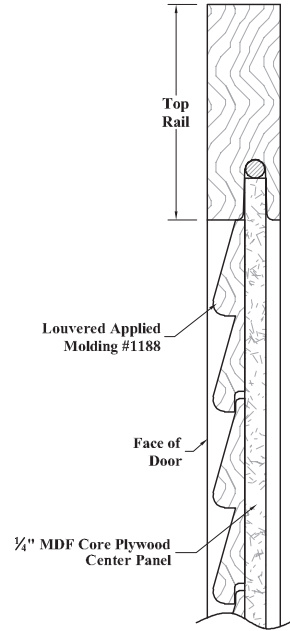
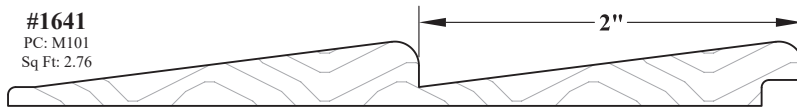
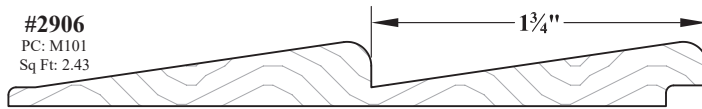
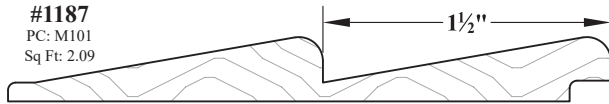
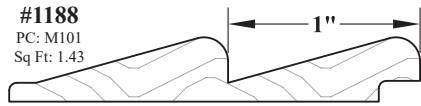
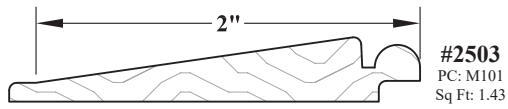

Beaded/Reeded Applied Molding Options - Interior Use Only

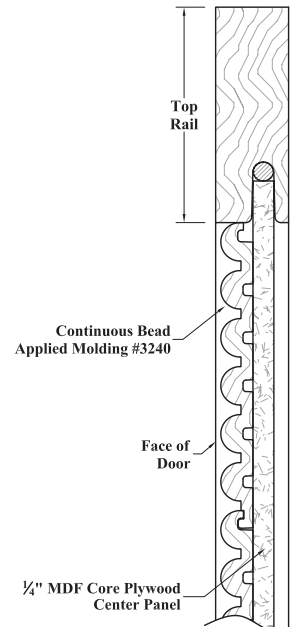
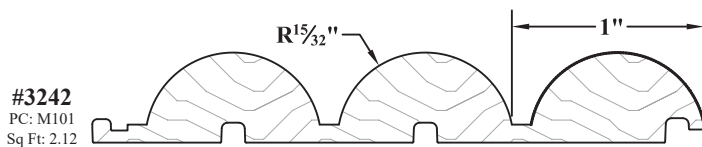
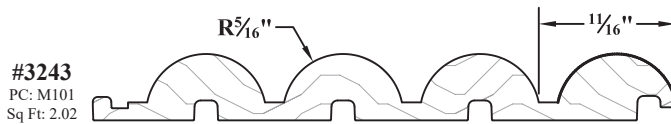
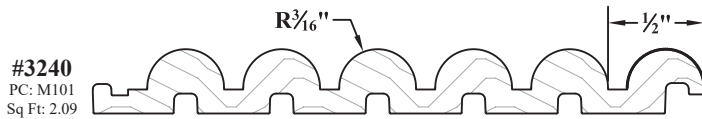
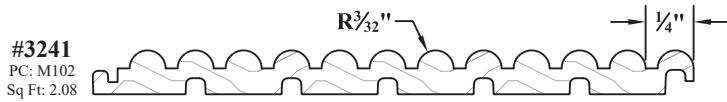
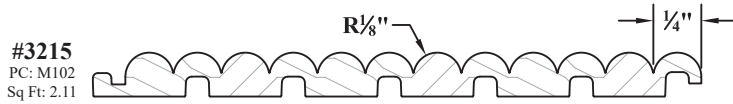

► For PRICING ► See Section B.15 in our current Wholesale Pricing Catalog.

**Ordering & Pricing Notes: Louvered Doors/Wood Shutters - Closed Louvers****Ordering Guidelines**

1	Order Forms	Please use <i>Door Order Form (E•Z Form #2)</i> .
---	-------------	---

**Pricing**

1	Pricing	Please see <i>Section B.15</i> of our current <b>Wholesale Pricing Catalog</b> .
---	---------	--

**Technical Notes: Louvered Doors/Wood Shutters - Closed Louvers****Cabinet Door & Drawer Front Options (Chapter B)**

1	Door Styles	Available in the following door styles: 40, 1400, 1401, 2428, 2434, 2632L/R, 3010, 3060L/R, 3160, 3170, 3231L/R, 3232L/R, 3234, 3235, 3271, 3272, 3284L/R, 3289L/R, 3291L/R, 3465, 4020, 4030, 4040, 4041, 4043, 4044, 4045, 4150.
---	-------------	--

**Functional Options (Chapter F)**

1	Hinge Boring	Hinge boring is available for Louvered Doors/Wood Shutters - Closed Louvers. Please see <i>Section F.1</i> for additional hinge boring requirements, ordering instructions and compatibility.
---	--------------	---

**General Information (Chapter A)**

1	Interior Use Only	WalzCraft's Louvered Doors/Wood Shutters are intended for interior use only.
2	Ready to Assemble (RTA)	RTA is <i>not</i> available as an option.

**Material Options**

1	Availability	Closed Louver doors are available in solid wood, raw MDF or Hybrid/MDF.
2	MDF Stiles/Rails with Solid Wood Louver Molding	When stiles/rails are MDF, the closed louver molding will be made from one of the following: <ul style="list-style-type: none"> <li>• Maple-Hard/Soft-Mixed-Value/Budget/Paint Grade</li> <li>• Birch-Value/Budget/Paint Grade</li> <li>• Poplar-Value/Budget/Paint Grade.</li> </ul>

**Miscellaneous**

1	Air Flow/Light	Closed Louver doors <i>do not</i> accommodate air flow or light penetration.
---	----------------	--

**Molding Options (Chapter N)**

1	Interlocking Moldings	Interlocking louver slat moldings and beaded applied moldings are designed to be affixed to a ¼" [6.4mm] veneered panel or a ¼" [6.4mm] raw MDF panel, to simulate <i>open</i> louvers. <ul style="list-style-type: none"> <li>• Louver slat molding are only available in a horizontal (left to right) orientation.</li> <li>• When ordering beaded applied molding, please specify your preference for the direction/placement as either horizontal (left to right) or vertical (top to bottom).</li> </ul> <p>These moldings are cut to fit. As a result, you may end up with a partial louver slat or bead on the center panel. The stile/rail widths will be unaltered.</p> <p>Molding drawings are shown at full scale.</p>
2	Louvered Moldings	See previous page for closed louver and beaded applied molding options and for information needed to order 8' pieces of molding only. Pricing for individual 8' moldings can be found in <i>Section N.12</i> of our current <b>Wholesale Pricing Catalog</b> .

**Profile Options (Chapter E)**

1	Stile & Rail Profile	SR100 will accept molding, #1187, #1188, #1641, #2503, #2906, #3215, #3240, #3241, #3243. SR195 will accept molding #3242.
---	----------------------	---

**Sizes/Dimensions**

1	Thicknesses	When using Traditional stile and rail profile SR100, closed louver doors made from solid wood are available ¾" [19.3mm] and 1" [25.4mm] thick. When using Old World stile and rail profile SR195, closed louver doors made from solid wood are available 1" [25.4mm], 1½" [28.6mm] and 1¾" [31.8mm] thick. See <i>Section S.3</i> for possible thickness restrictions based on wood species.
2	Maximum Opening Sizes	The maximum size for openings on closed louver doors that WalzCraft will warrant is 36"W and / or 36"H. Closed louver doors with openings greater than this will carry no warranty against bowing. If ordering closed louver doors with openings greater than 36"W and / or 36"H, we recommend 3" wide (or greater) stiles/rails. This will provide more structural stability and help to prevent bowing which can open up gaps between the stiles/rails and the louver molding.

Continued on next page...

► For PRICING ► See Section B.15 in our current Wholesale Pricing Catalog.

**Technical Notes: Louvered Doors/Wood Shutters - Closed Louvers...continued**

**Sizes/Dimensions...continued**

3	Minimum Sizes	Please reference the <i>Louver Door Minimum Sizes</i> compatibility chart on our website under: <b>Resources &gt; Technical Information</b> . This chart will give you the minimum sizes for operable, non-operable and fixed louver door styles based on louver size.
---	---------------	--

**Wood Species Options (Chapter S)**

1	Style 1000 and 8000 Closed Louver Doors	For available wood species options for the solid wood raised panel, and the corresponding wood species used for the ¼" flat panel that the closed louvers attached to, please see <i>Closed Louver Doors with Raised Panel - Wood Species Options</i> chart on our website under <b>Resources &gt; Technical Information</b> .
---	---	--

**Closed Louver Doors - END**

► For PRICING ► See Section **B.15** in our current Wholesale Pricing Catalog.

Drawer Front "Looks" - Compatible with 3/4" [19.1mm] Thick Doors

- These Drawer Front "Looks" are compatible with doors that are 3/4" [19.1mm] thick.
- When ordering you will need to determine which "Look" best suits your needs.
- Each "Look" has a code (ie: A - D) that is part of the drawer front style number (ie: 34SQA\* or 300-32RPB\* or 300-32RPC\*).
- When placing your order, please indicate the code for the "Look", along with the RP Profile (*Section B.16*) and/or outside edge (*Section E.15*) when appropriate.

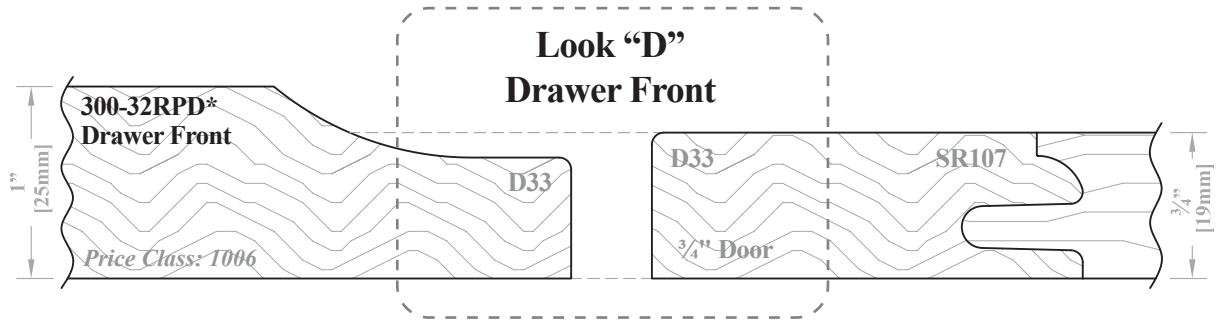
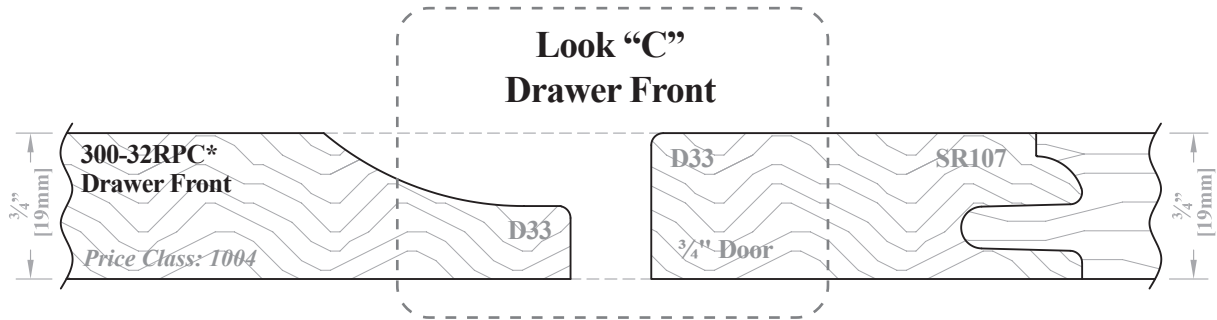
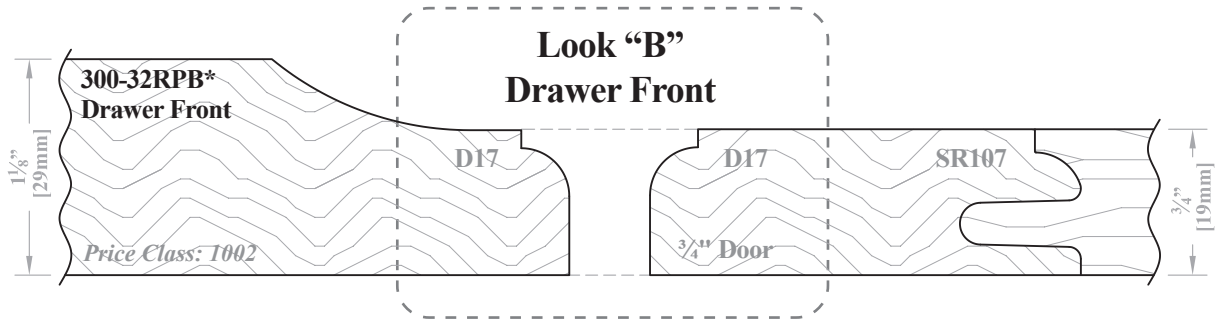
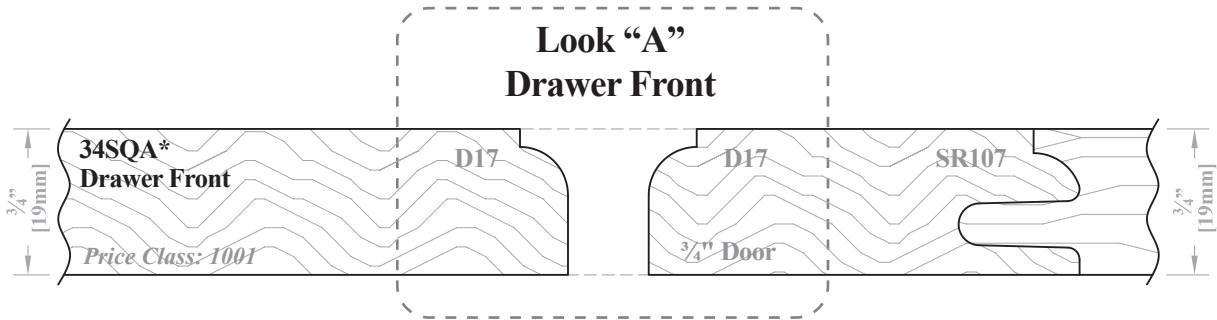

► For PRICING ► See Section B.16 in our current Wholesale Pricing Catalog.

**Slab & RP (Raised Panel) Drawer Front Styles**

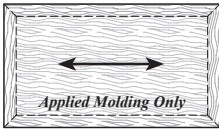

**Style: 916SQA\***  
**Drawer Front**  
 PC: 1001  
 Frame: NA  
 Min. Size: 3x3

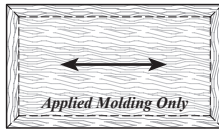

**Style: 58SQA\***  
**Drawer Front**  
 PC: 1001  
 Frame: NA  
 Min. Size: 3x3

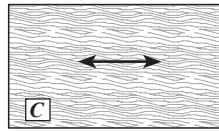

**Style: 34SQA\***  
**Drawer Front**  
 PC: 1001  
 Frame: NA  
 Min. Size: 3x3  
 See Look "A"

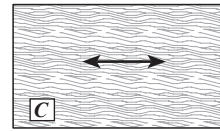

**Style: 100SQE\***  
**Drawer Front**  
 PC: 1003  
 Frame: NA  
 Min. Size: 3x3  
 See Look "E"

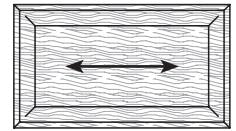

**Style: RP\***  
**Drawer Front**  
 PC: Varies  
 Frame: NA  
 Min. Size: Varies  
 See Look "B, C, D, F & G"

**Drawer Front "Looks" - Compatible with 1" [25.4mm] Thick Doors**

- These Drawer Front "Looks" are compatible with doors that are 1" [25.4mm] thick.
- When ordering you will need to determine which "Look" best suits your needs.
- Each "Look" has a code (ie: E-G) that is part of the drawer front style number (ie: 100SQE\* or 300-32RPF\* or 300-32RPG\*).
- When placing your order, please indicate the code for the "Look", along with the RP Profile (Section B.16) and/or outside edge (Section E.15) when appropriate.

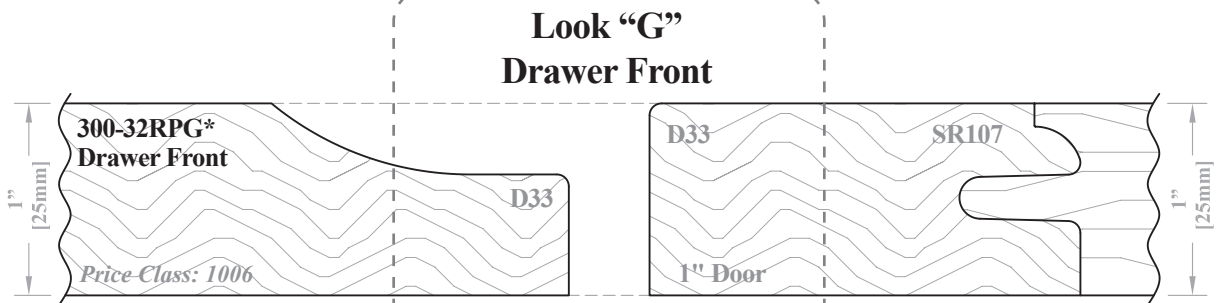
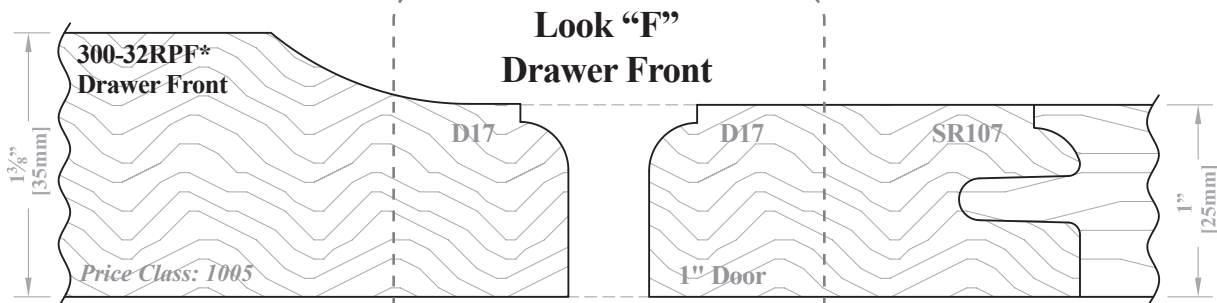
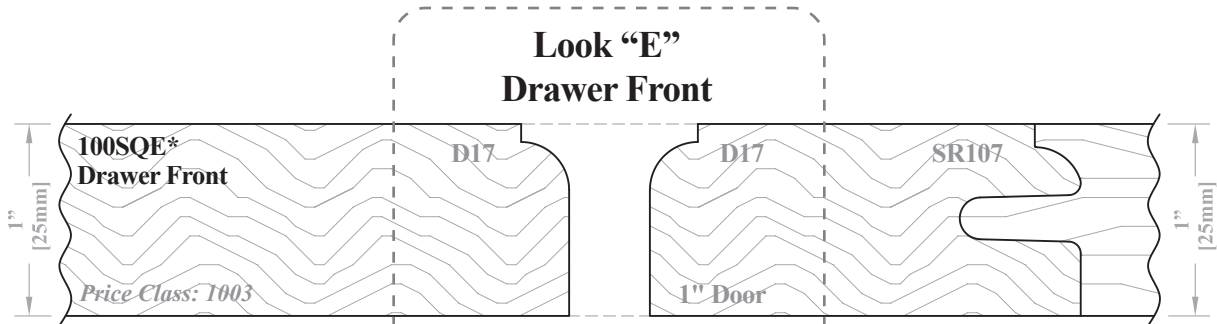

► **For PRICING** ► See Section B.16 in our current Wholesale Pricing Catalog.

Outside Edge Profiles for Raised Panel Drawer Fronts

Using outside edge profiles that simulate a raised panel "Look", with a slab drawer front like Style 34SQA\* or 100SQE\*, is a more economical alternative than other raised panel drawer front "Looks" (ie: Look "B" or "C") that require multiple router passes for manufacturing.

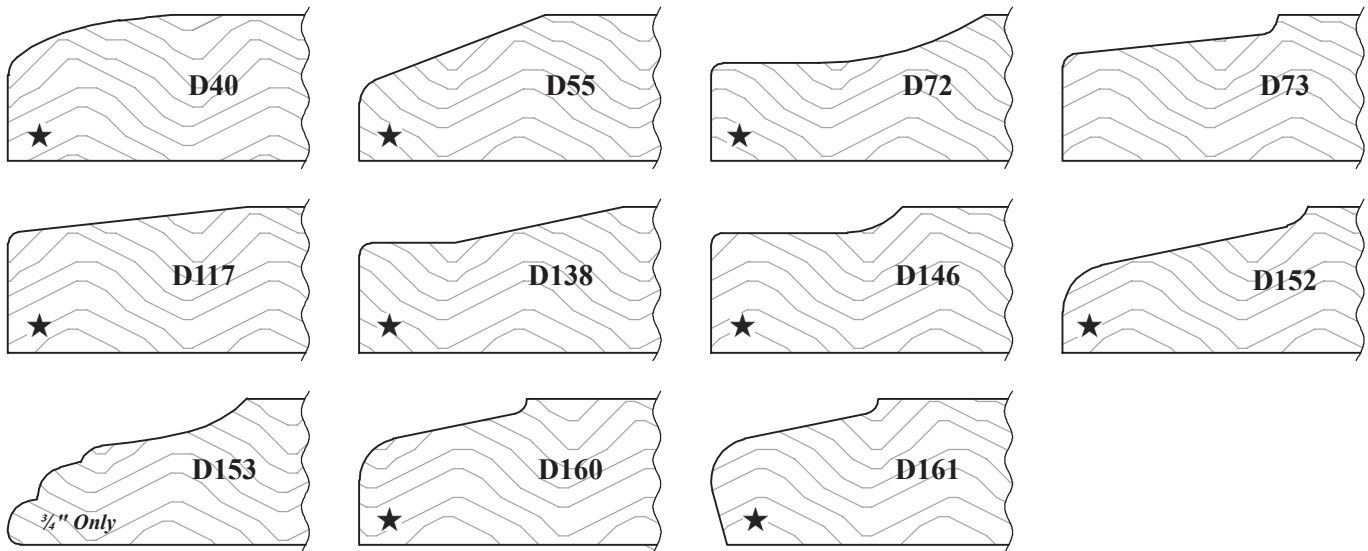
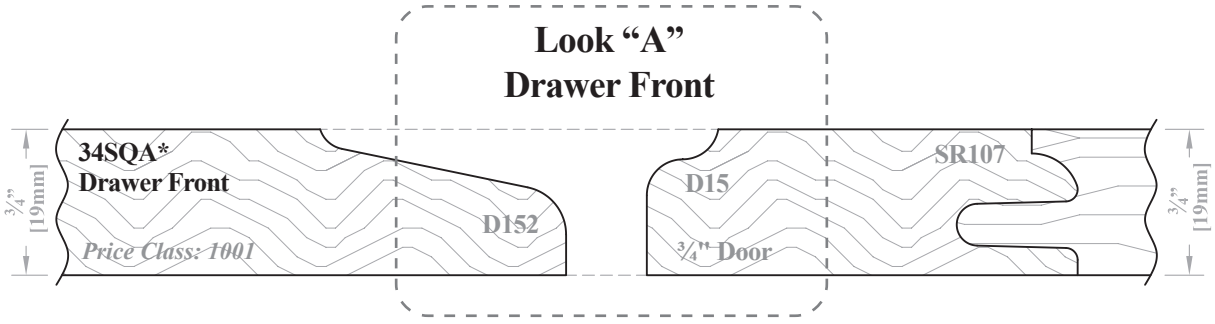

★ = Available on products using 3D Laminate (RTF).

► For PRICING ► See Section **B.16** in our current Wholesale Pricing Catalog.

Raised Panel Profiles for RP (Raised Panel) Drawer Fronts

B

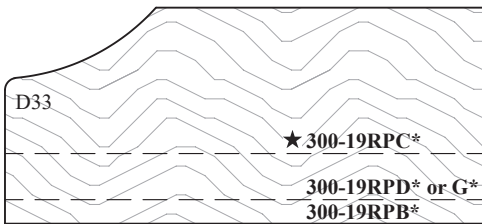
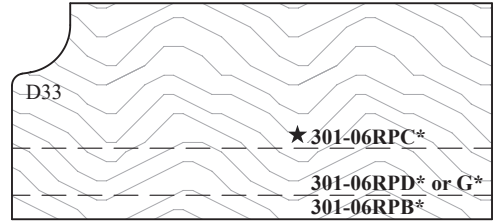
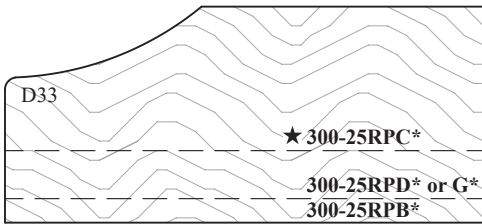
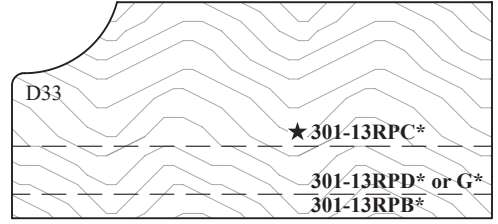
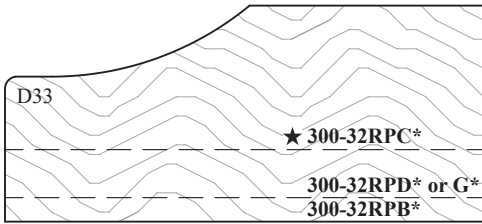
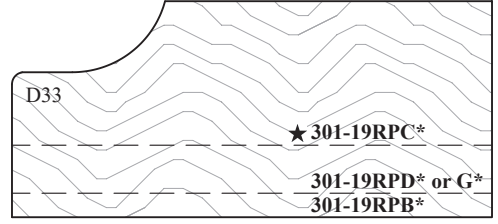
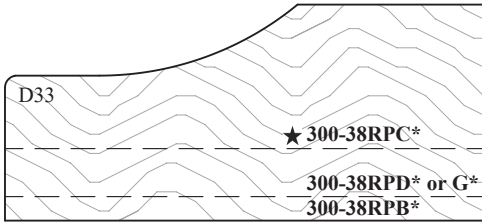
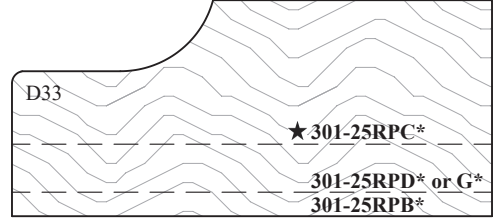
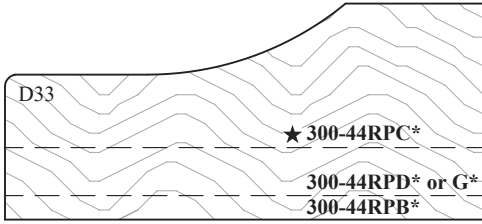
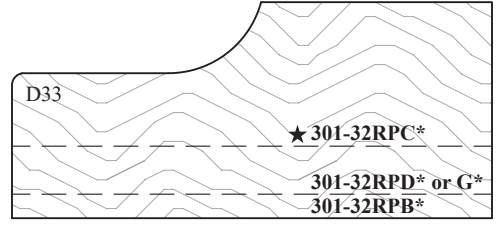
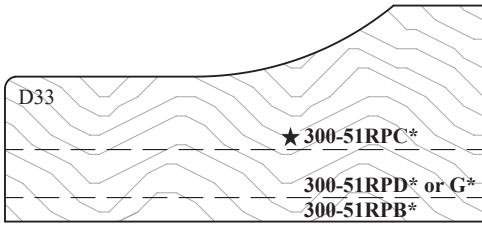

★ = Available on products using 3D Laminate (RTF).

Note: Dashed lines indicate difference in thickness from one look to another. Look "B" = 1/8" [28.6mm], Look "D" or "G" = 1" [25.4mm], Look "C" = 3/4" [19.1mm].

Raised Panel Profiles for RP (Raised Panel) Drawer Fronts

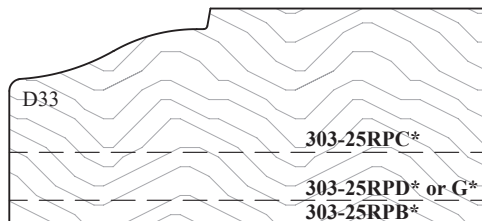
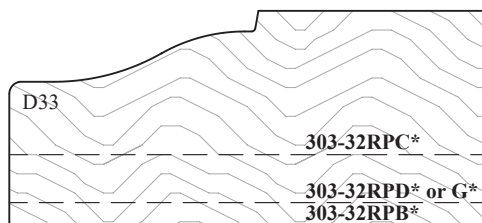
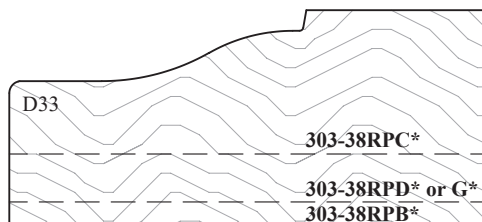
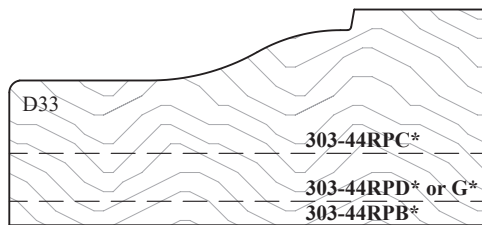
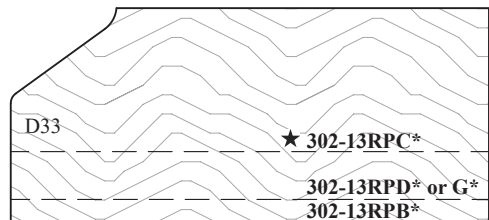
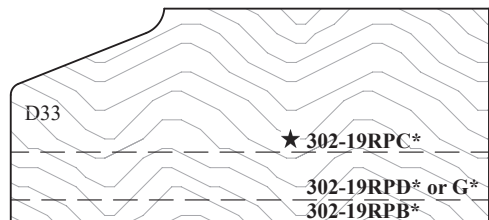
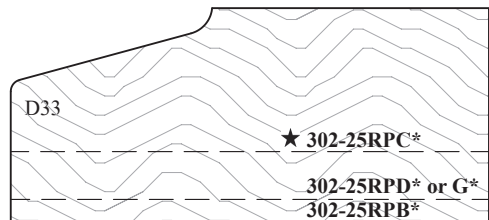
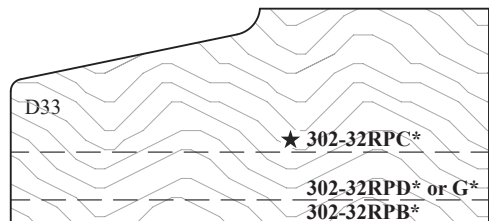
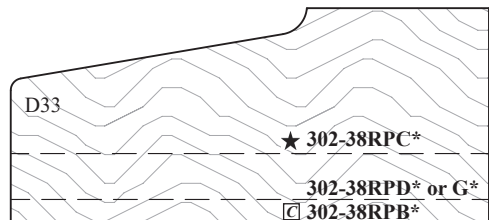
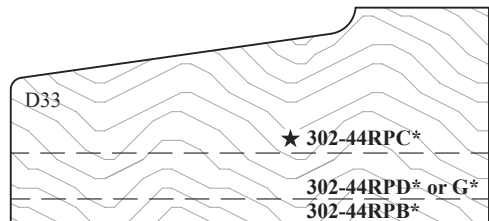
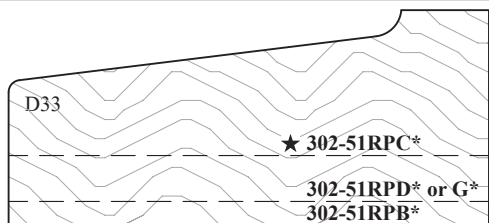

★ = Available on products using 3D Laminate (RTF).

☐ = Available for Convex/Concave Products.

Note: Dashed lines indicate difference in thickness from one look to another. Look "B" = 1 1/8" [28.6mm], Look "D" or "G" = 1" [25.4mm], Look "C" = 3/4" [19.1mm].

Raised Panel Profiles for RP (Raised Panel) Drawer Fronts

B

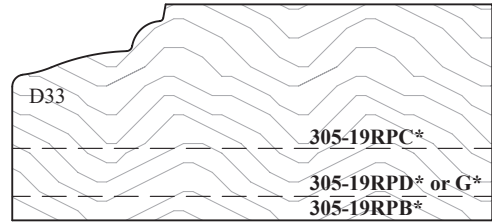
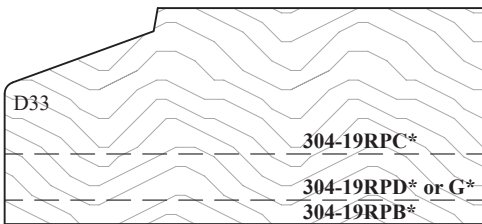
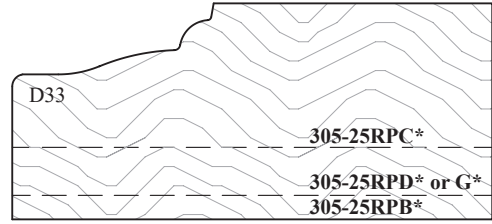
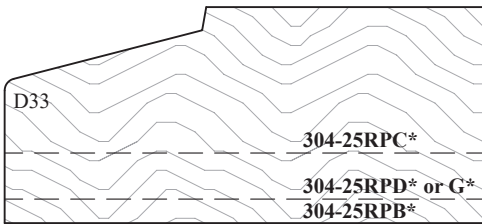
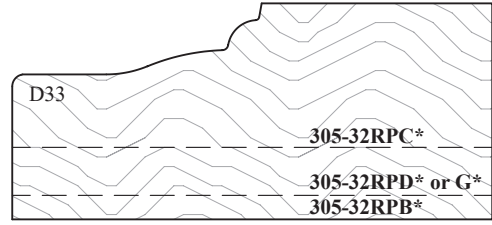
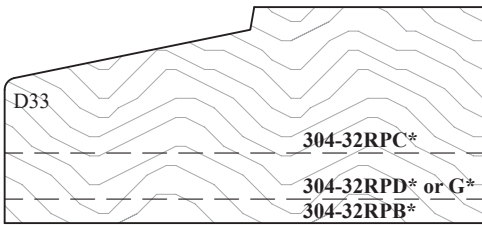
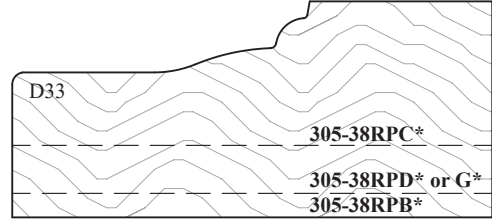
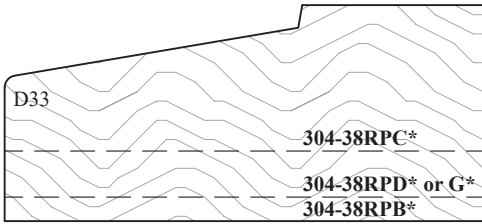
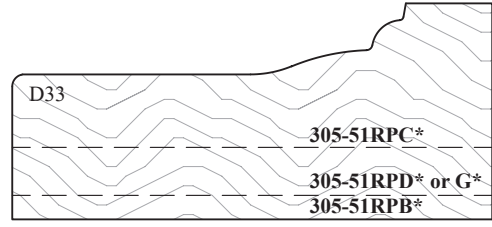
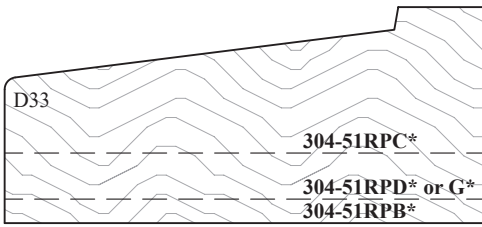

★ = Available on products using 3D Laminate (RTF).

Note: Dashed lines indicate difference in thickness from one look to another. Look "B" = 1 1/8" [28.6mm], Look "D" or "G" = 1" [25.4mm], Look "C" = 3/4" [19.1mm].

► For PRICING ► See Section B.16 in our current Wholesale Pricing Catalog.

Raised Panel Profiles for RP (Raised Panel) Drawer Fronts

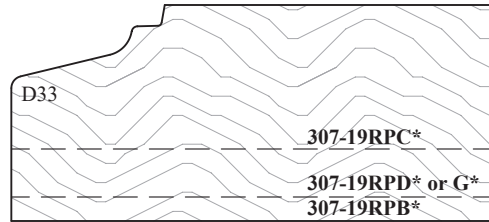
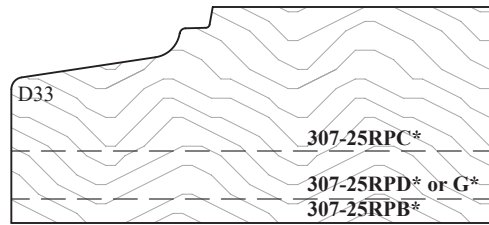
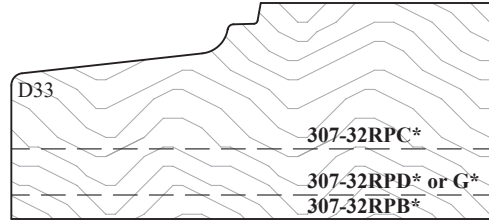
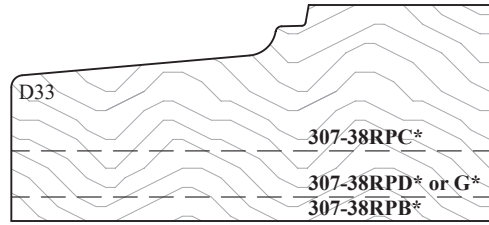
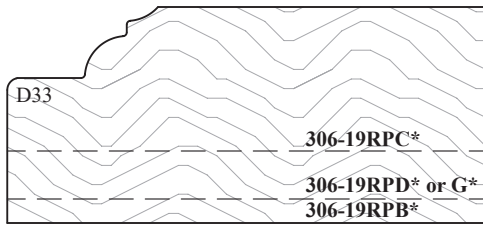
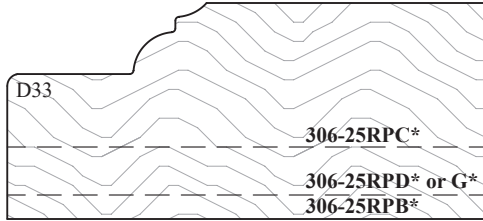
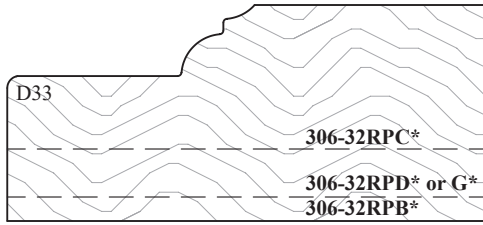

★ = Available on products using 3D Laminate (RTF).

► For PRICING ► See Section **B.16** in our current Wholesale Pricing Catalog.

Raised Panel Profiles for RP (Raised Panel) Drawer Fronts

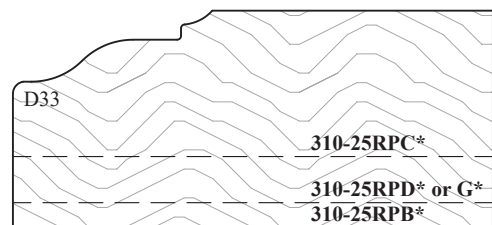
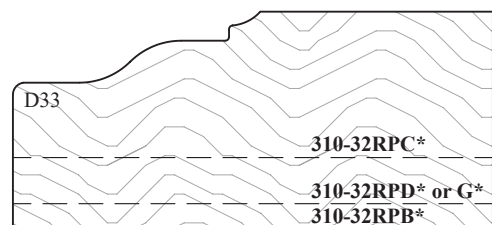
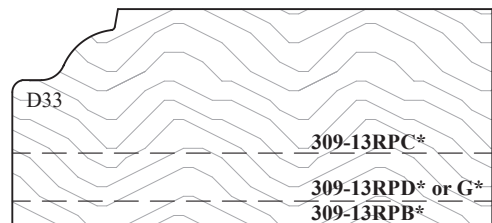
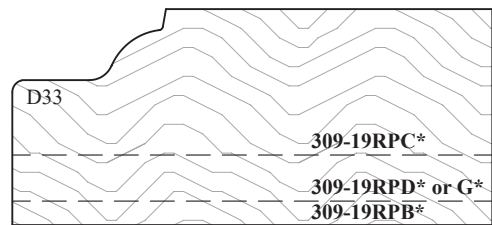
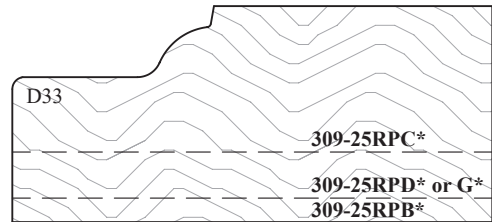
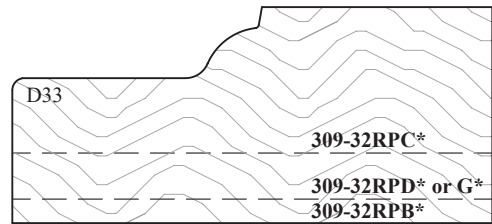
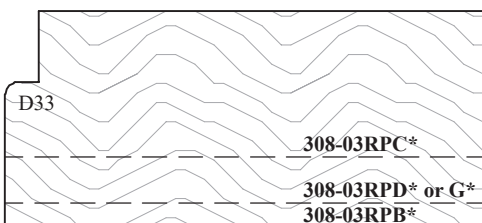
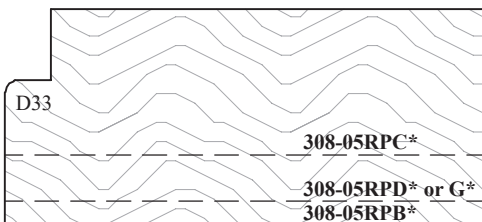
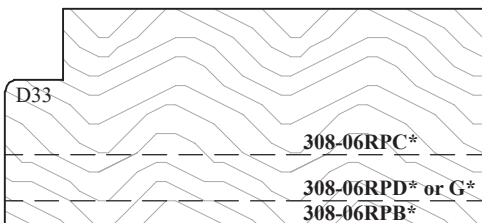
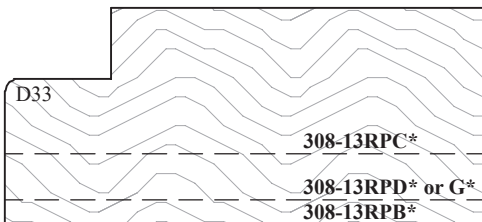
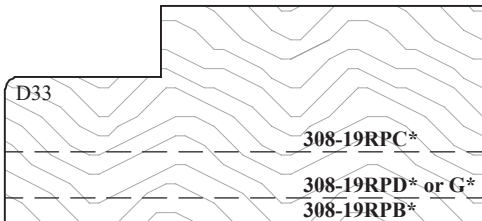
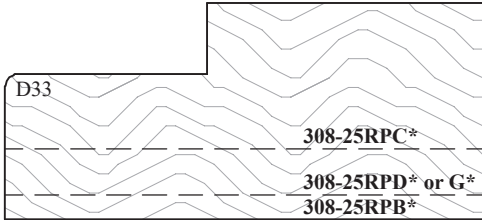
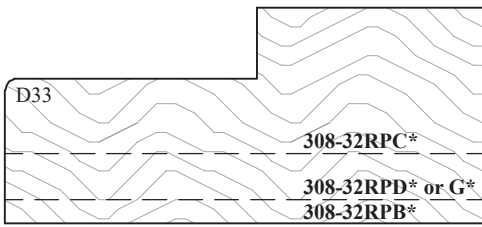

★ = Available on products using 3D Laminate (RTF).

Note: Dashed lines indicate difference in thickness from one look to another. Look "B" = 1½" [28.6mm], Look "D" or "G" = 1" [25.4mm], Look "C" = ¾" [19.1mm].

Raised Panel Profiles for RP (Raised Panel) Drawer Fronts

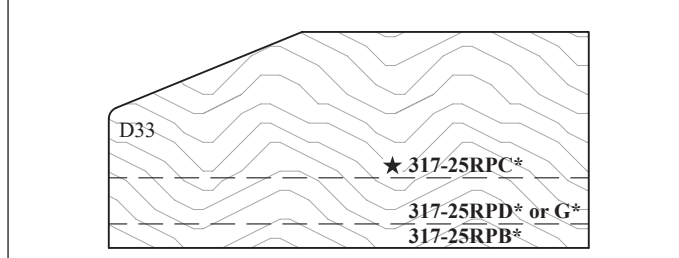
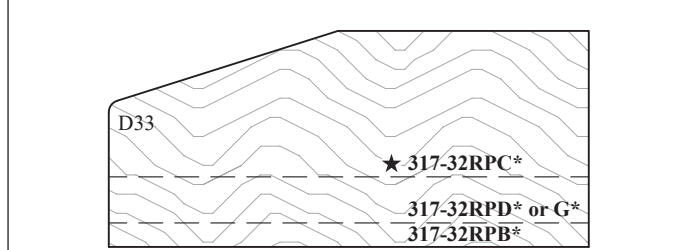
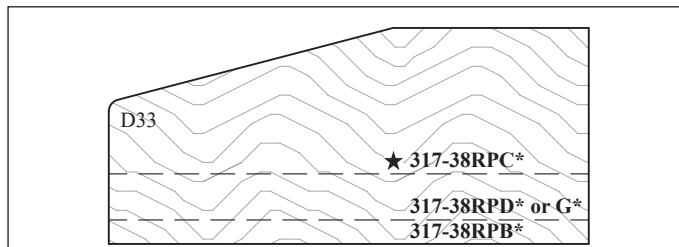
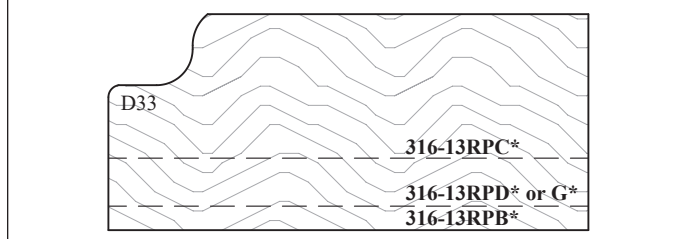
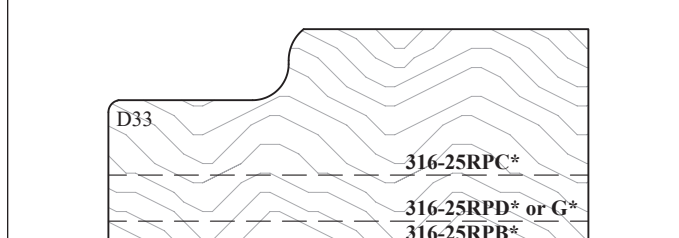
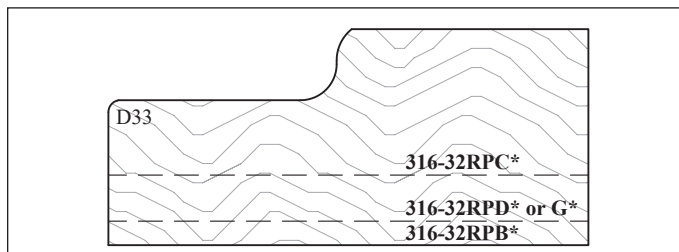
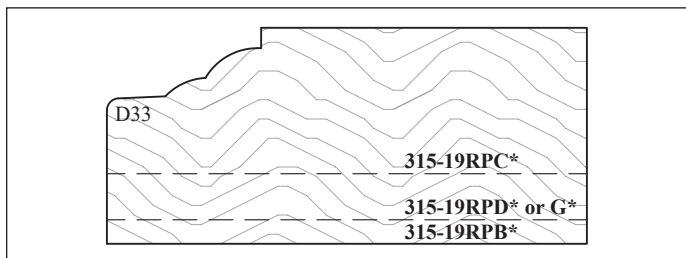
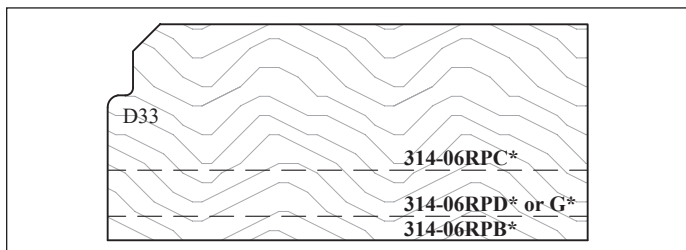
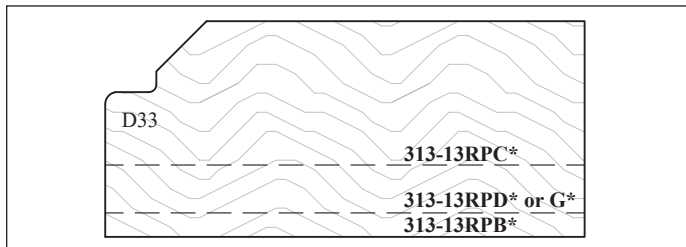
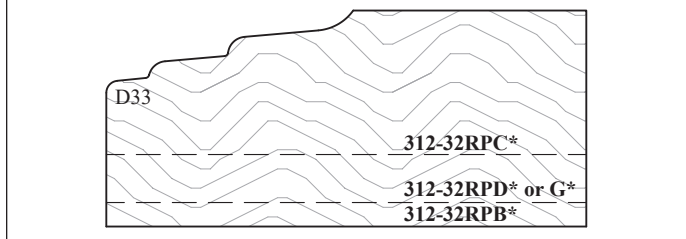
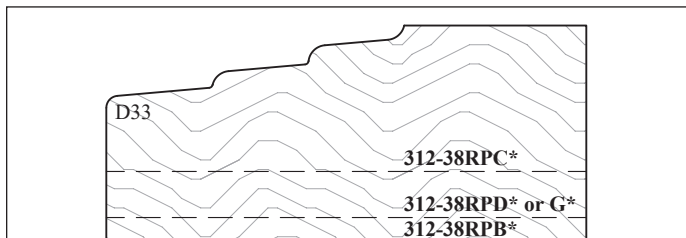
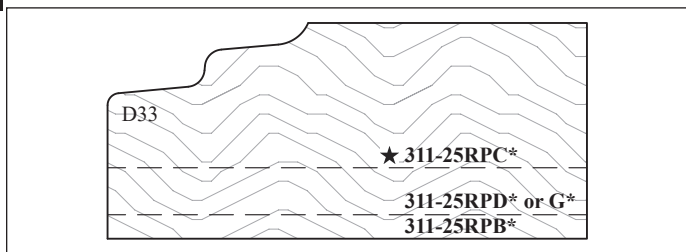

Note: Dashed lines indicate difference in thickness from one look to another. Look "B" = 1 1/8" [28.6mm], Look "D" or "G" = 1" [25.4mm], Look "C" = 3/4" [19.1mm].

► For PRICING ► See Section B.16 in our current Wholesale Pricing Catalog.

Raised Panel Profiles for RP (Raised Panel) Drawer Fronts

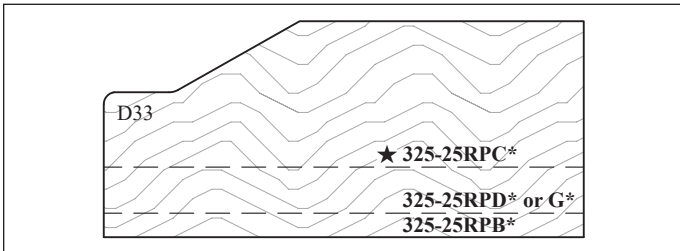
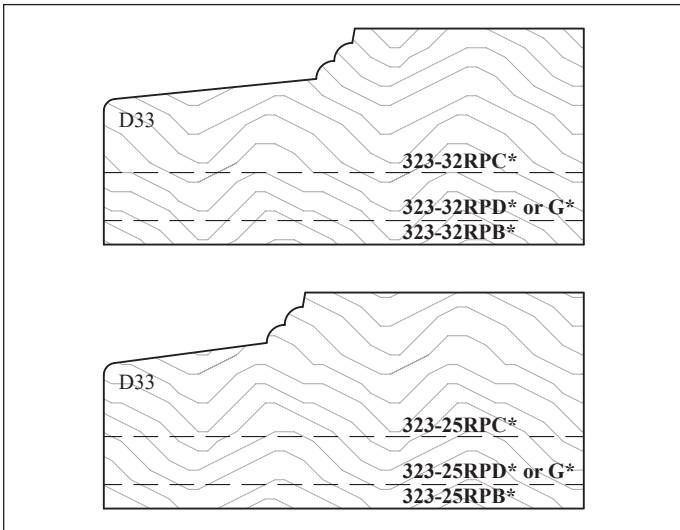
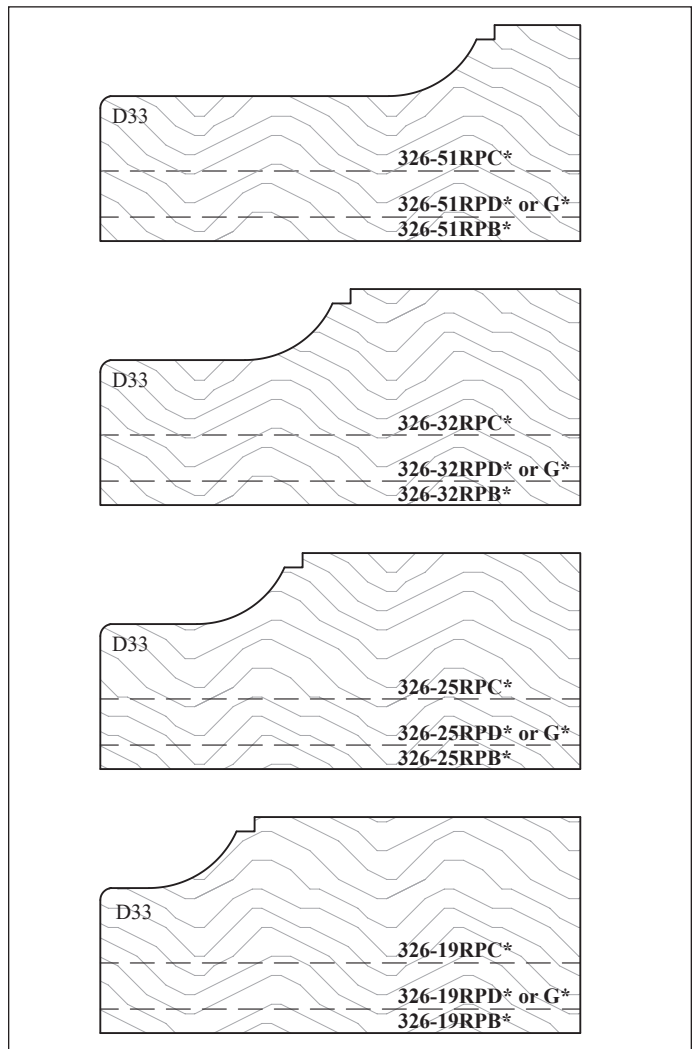
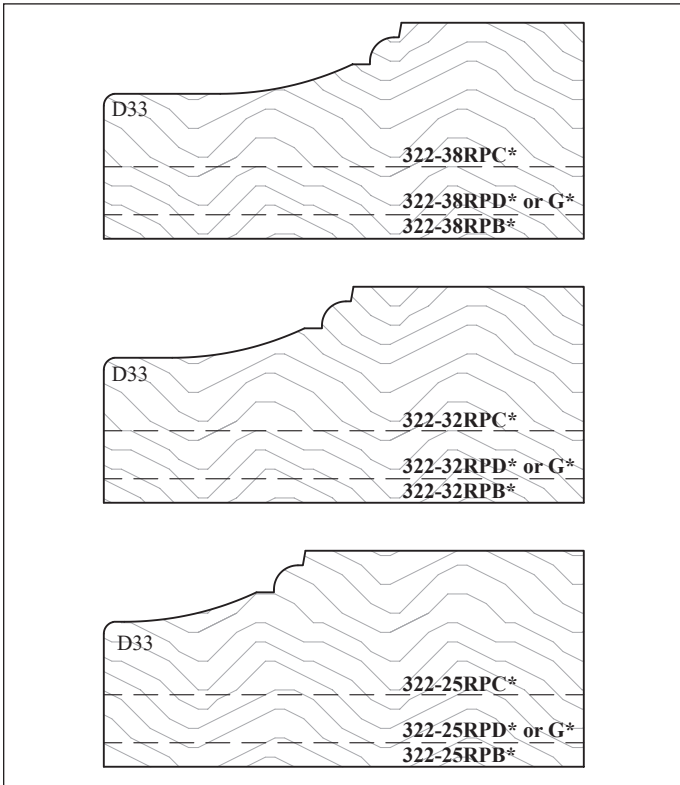

★ = Available on products using 3D Laminate (RTF).

Note: Dashed lines indicate difference in thickness from one look to another. Look "B" = 1 1/8" [28.6mm], Look "D" or "G" = 1" [25.4mm], Look "C" = 3/4" [19.1mm]. Some Look "B" profiles shown on this page are 1 5/16" [23.8mm] thick.

► For PRICING ► See Section B.16 in our current Wholesale Pricing Catalog.

Raised Panel Profiles for RP (Raised Panel) Drawer Fronts

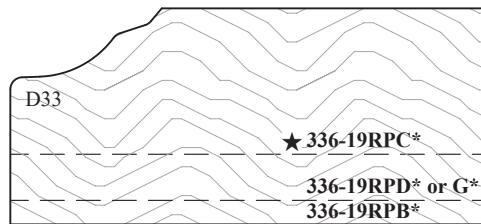
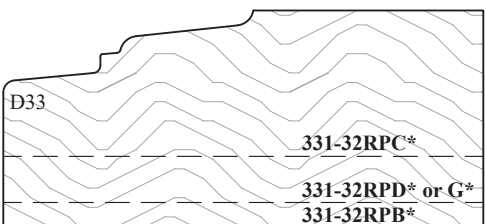
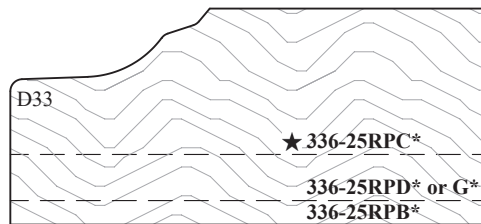
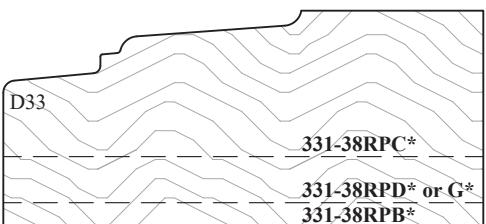
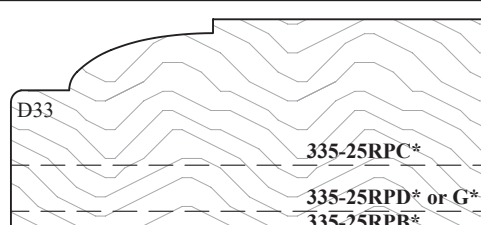
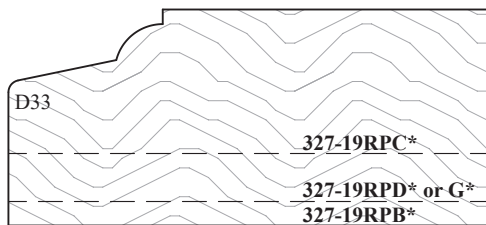
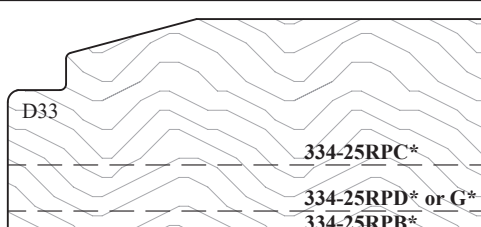
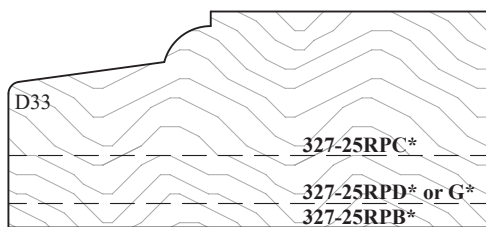
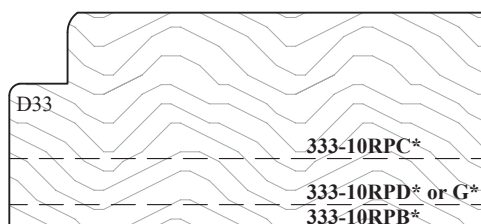
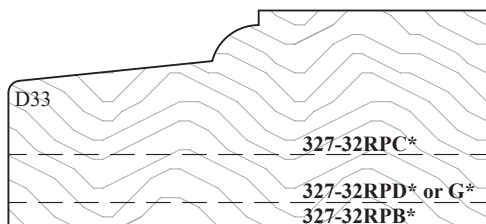
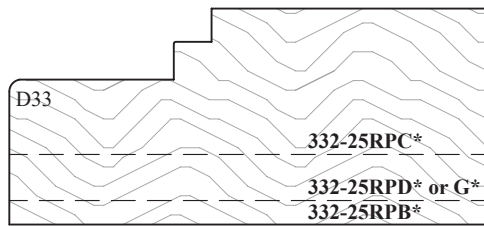
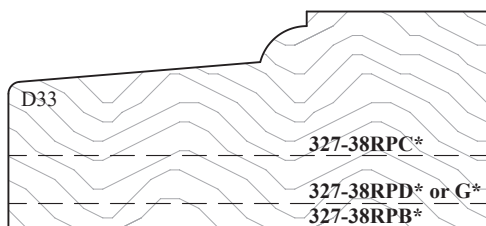

**Note:** Dashed lines indicate difference in thickness from one look to another. Look "B" = 1 1/8" [28.6mm], Look "D" or "G" = 1" [25.4mm], Look "C" = 3/4" [19.1mm]. Some Look "B" profiles shown on this page are 1 5/16" [23.8mm] thick.

Raised Panel Profiles for RP (Raised Panel) Drawer Fronts

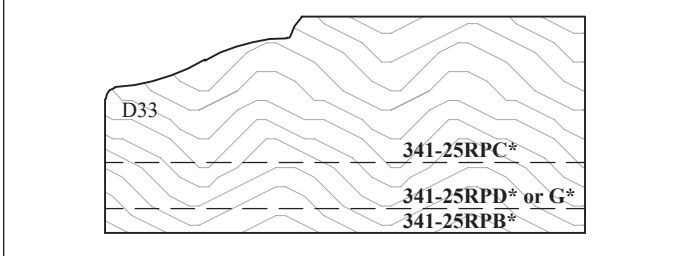
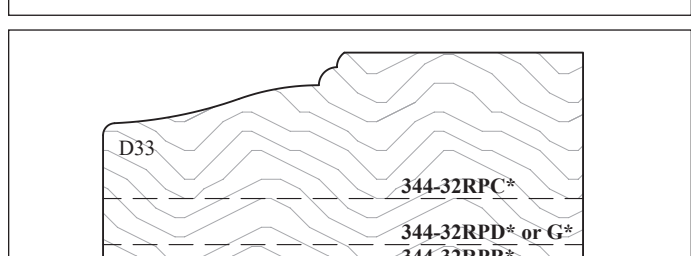
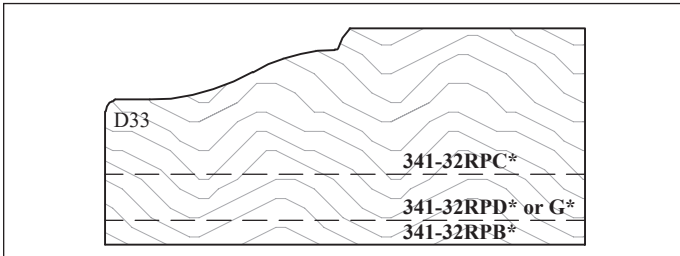
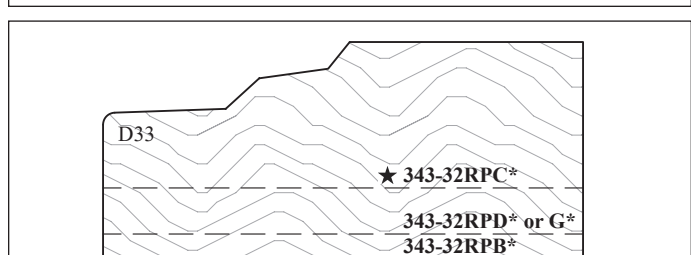
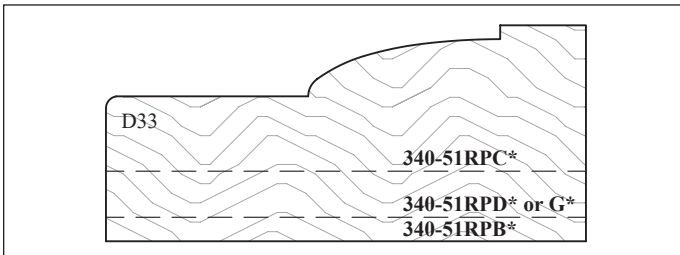
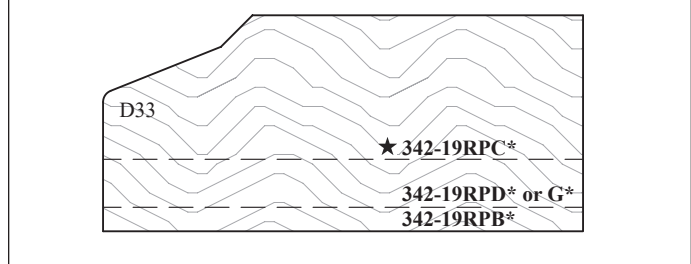
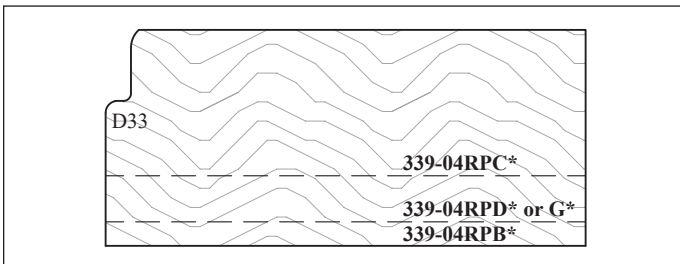
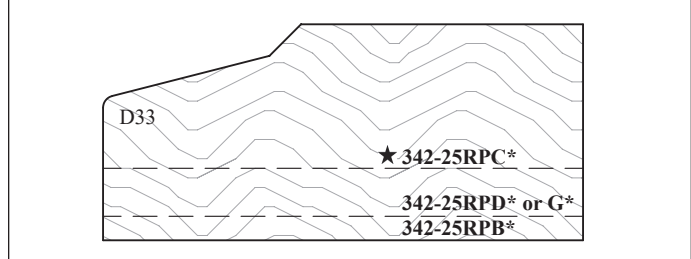
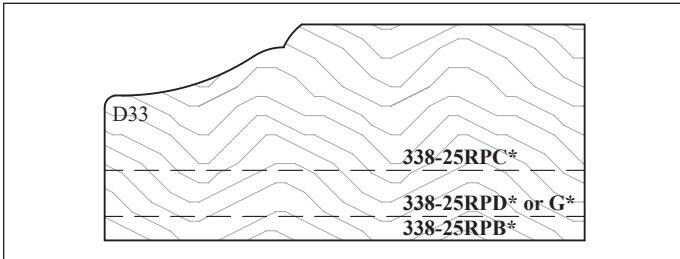
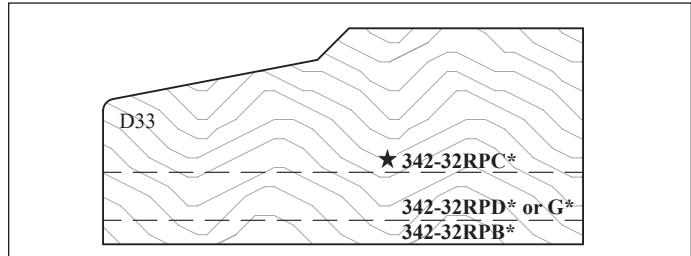
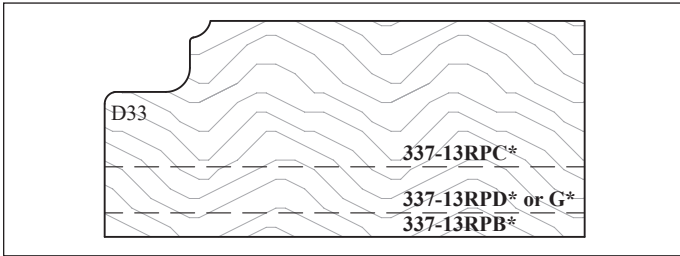

★ = Available on products using 3D Laminate (RTF).

► For PRICING ► See Section B.16 in our current Wholesale Pricing Catalog.

Raised Panel Profiles for RP (Raised Panel) Drawer Fronts

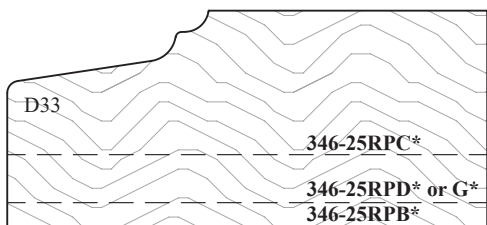
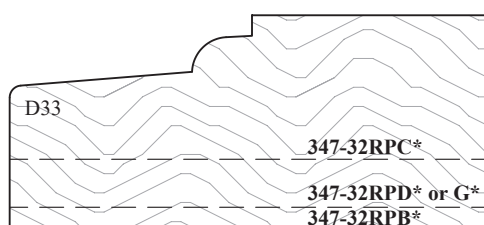
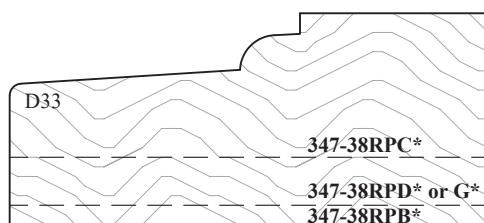
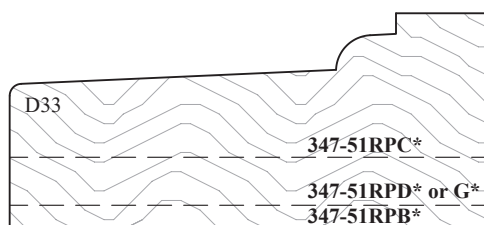
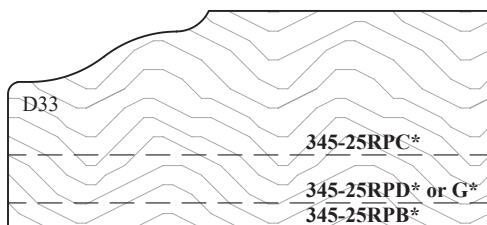
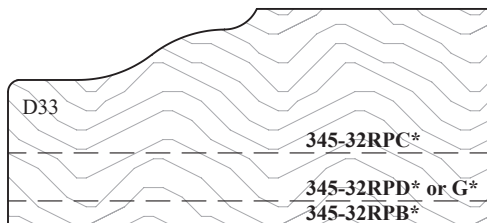
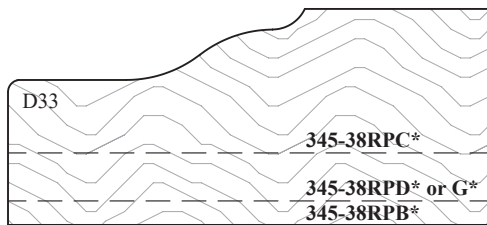

★ = Available on products using 3D Laminate (RTF).

Note: Dashed lines indicate difference in thickness from one look to another. Look "B" = 1 1/8" [28.6mm], Look "D" or "G" = 1" [25.4mm], Look "C" = 3/4" [19.1mm].

► For PRICING ► See Section B.16 in our current Wholesale Pricing Catalog.

Raised Panel Profiles for RP (Raised Panel) Drawer Fronts

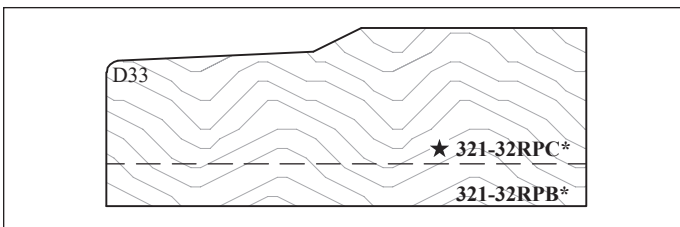
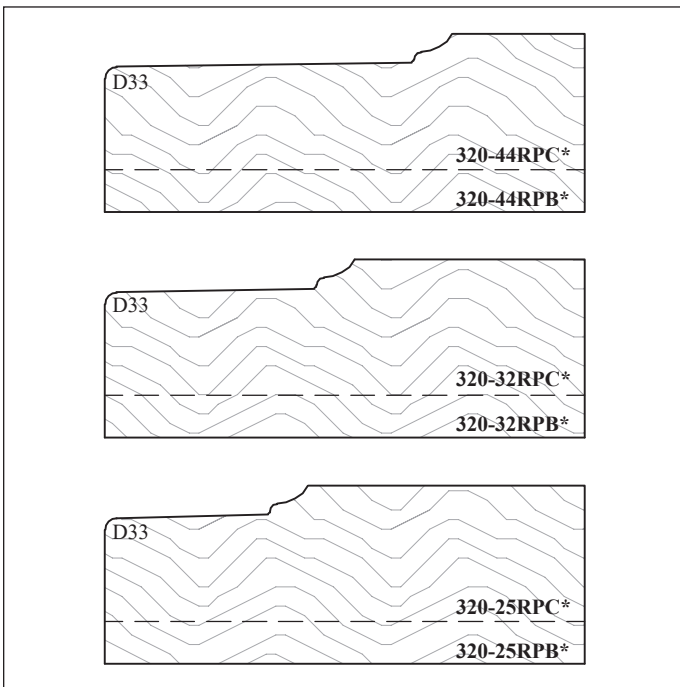
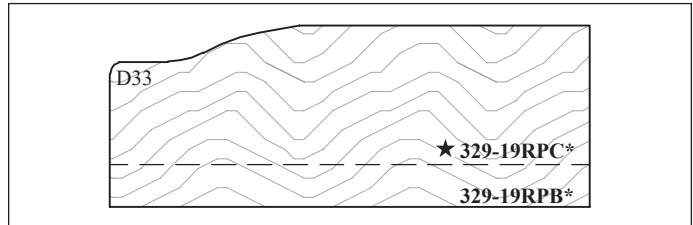
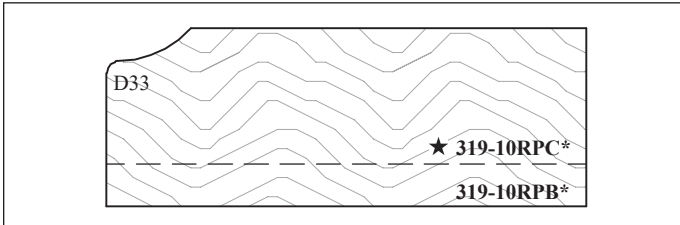
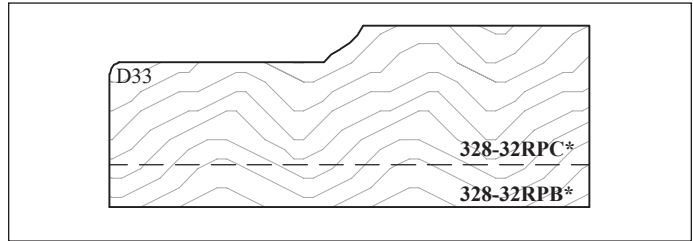
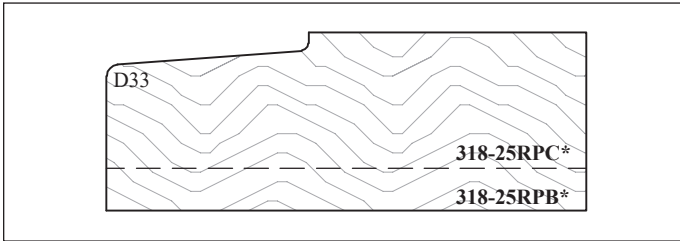

★ = Available on products using 3D Laminate (RTF).

Note: Dashed lines indicate difference in thickness from one look to another. Look "B" = 15/16" [23.8mm], Look "C" = 3/4" [19.1mm]. Door style 1271 and drawer front style 1271\* from Section B.9 are only available with these 15/16" [23.8mm] thick Look "B" profiles.

► For PRICING ► See Section B.16 in our current Wholesale Pricing Catalog.

**Minimum Size Drawer Front Calculation**

- The minimum sizes for drawer fronts are calculated using the *Raised Panel Profile Reveal* and the *Outside Edge Profile Width*, while maintaining a 1" [25.4mm] minimum of flat to the face.
- Dimensions for raised panel profile reveals and outside edge profiles can be found on the compatibility chart on our website under Technical Information.

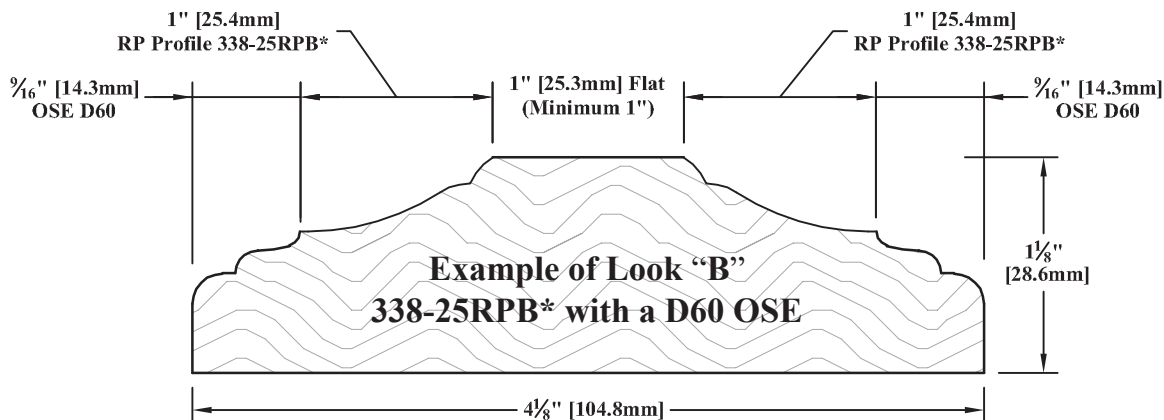

Example per drawing: (D60 @ 1/16" x 2 = 1/8") + (338-25RPB\* @ 1" x 2 = 2") + (1" Flat) = 4 1/8"

**Ordering & Pricing Notes: Slab & RP (Raised Panel) Drawer Fronts**

**Ordering Guidelines**

**1 Order Forms** Please use *Drawer Front Order Form (E-Z Form #3)*.

**Pricing**

**1 Pricing** Please see *Section B.16* of our current **Wholesale Pricing Catalog**.

**Technical Notes: Slab & RP (Raised Panel) Drawer Fronts**

**Cabinet Door & Drawer Front Options (Chapter B)**

<b>1</b>	<b>Style 916SQA*, 58SQA*</b>	Style 916SQA* is only available when using one of the 1/16" <i>Only [14mm]</i> Outside Edge Applied Molding profiles from <i>Section E.16</i> .
		Style 58SQA* is only available when using one of the 3/8" <i>Only [15.9mm]</i> Outside Edge Applied Molding profiles from <i>Section E.16</i> .
		MDF core is recommended when using these drawer front styles with applied molding due to expansion and contraction issues that may occur.
<b>2</b>	<b>Style 34SQA*</b>	See Look "A" on <i>page B.16.1</i> .
<b>3</b>	<b>RP Drawer Fronts</b>	See the Drawer Front "Look" options that are available on <i>pages B.16.1 &amp; B.16.2</i> . Standard raw MDF Raised Panel (RP) drawer fronts are available in all Drawer Front "Looks".

**Convex/Concave Options (Chapter D)**

**1 Curved Products** The C indicates drawer front styles that are available for Curved Products. For additional ordering guidelines, see *Chapter D*.

**Functional Options (Chapter F)**

**1 Hinge Boring** 35mm hinge boring is available with Drawer Front Looks "A", "B", "E" and "F". Please see *Section F.1* for additional hinge boring requirements, ordering instructions and compatibility.  
For Drawer Front Looks "C", "D" and "G" please submit your request to our Customer Support Team.

**Material Options**

**1 Raw MDF-MR** Raw MDF-MR is only available with Drawer Front Look "A" and Look "C".

*Continued on next page...*

► **For PRICING** ► See *Section B.16* in our current Wholesale Pricing Catalog.

Technical Notes: Drawer Fronts (Slab & RP)...continued

General Information (Chapter A)

1	Grain Direction	Arrows (↔) shown throughout the catalog indicate standard grain direction. Grain direction may be specified at <b>NO</b> additional cost.
2	Warranty	Please see <i>Section A.8 - Warranties</i> for more information on Glued-Up Panel expansion/contraction, warping, bowing and twisting.

Profile Options (Chapter E)

1	Look "C"	Outside edge thickness may vary by 5mm depending on the drawer front profile selected. Please refer to our website for more information.
2	Outside Edge Profiles	Most drawer front profiles are shown with a <b>D33</b> Outside Edge.
		Outside edge profiles can simulate a raised panel "Look" on a style <b>34SQA*</b> . <ul style="list-style-type: none"> <li>• Economical alternative - 1 router pass versus multiple passes.</li> <li>• Design flexibility is <b>not</b> an option.</li> </ul>
		Additional information for Outside Edge Profiles can be found on our website under Technical Information.
3	Raised Panel (RP) Style Drawer Front Profiles	You must choose an RP "Look", a Raised Panel Profile, and an Outside Edge Profile when ordering <b>RP</b> (Raised Panel) Drawer Fronts. The Raised Panel Profile # and the "Look" option define the <b>Style #</b> for your <b>RP</b> Drawer Front.

Sizes/Dimensions

1	Minimum Size	See previous page for minimum size calculations for RP drawer fronts. <b>916SQA*</b> , <b>58SQA*</b> , <b>34SQA*</b> , <b>100SQE*</b> & <b>500*</b> = 3" x 3" [76.2mm x 76.2mm].
2	Maximum Height	Maximum height for a glued up, solid wood drawer front with horizontal grain is 48" [1219.2mm].
3	Drawer Front Construction	Drawer fronts up to 6" [152.4mm] high will be constructed with no glue ups whenever possible. This does <b>not</b> apply to Paint/Budget/Value, Rustic and Knotty Grades of material.
4	Thicknesses	Slab and <b>RP</b> (Raised Panel) drawer fronts made from solid wood are available 5/16" [14.3mm], 3/8" [15.9mm], 1/2" [19.1mm], 1" [25.4mm], 1 1/8" [28.6mm] and 1 3/8" [34.9mm] thick.
		See <i>Section S.3</i> for possible thickness restrictions based on wood species.
		Not all drawer fronts are available in all thicknesses. See pages <b>B.16.1</b> and <b>B.16.2</b> for Price Classes (PC) and their associated thicknesses.
		1 3/8" thickness for standard raw MDF drawer fronts is achieved by laminating two layers together.

Slab & RP (Raised Panel) Drawer Fronts - END

► For PRICING ► See Section **B.16** in our current Wholesale Pricing Catalog.

B

Molded Drawer Fronts may be ordered in these configurations:

Molding #	8' Length	PCTH (Precision Cut to Height) Please Specify Height		PCTL (Precision Cut to Length) Please Specify Length (Width)	PCTS (Precision Cut to Size) Please Specify Length (Width) and Height
		Minimum Height			
1177*	Yes	Yes	5¾" [146.1mm]	Yes	Yes
1365*	Yes	* No	Fixed at 6¾" [171.5mm]	Yes	* No
1366*	Yes	* No	Fixed at 6¾" [171.5mm]	Yes	* No
1738*	Yes	Yes	5½" [139.7mm]	Yes	Yes
2158*	Yes	Yes	4½" [114.3mm]	Yes	Yes
2159*	Yes	Yes	6½" [165.1mm]	Yes	Yes

\* Molding #1365\* and #1366\* cannot be trimmed in height.

The minimum length for Cut-to-Length pieces is 3" [76.2mm]. For ordering, please use *Molding & Miscellaneous Order Form (E•Z Form #5)*.

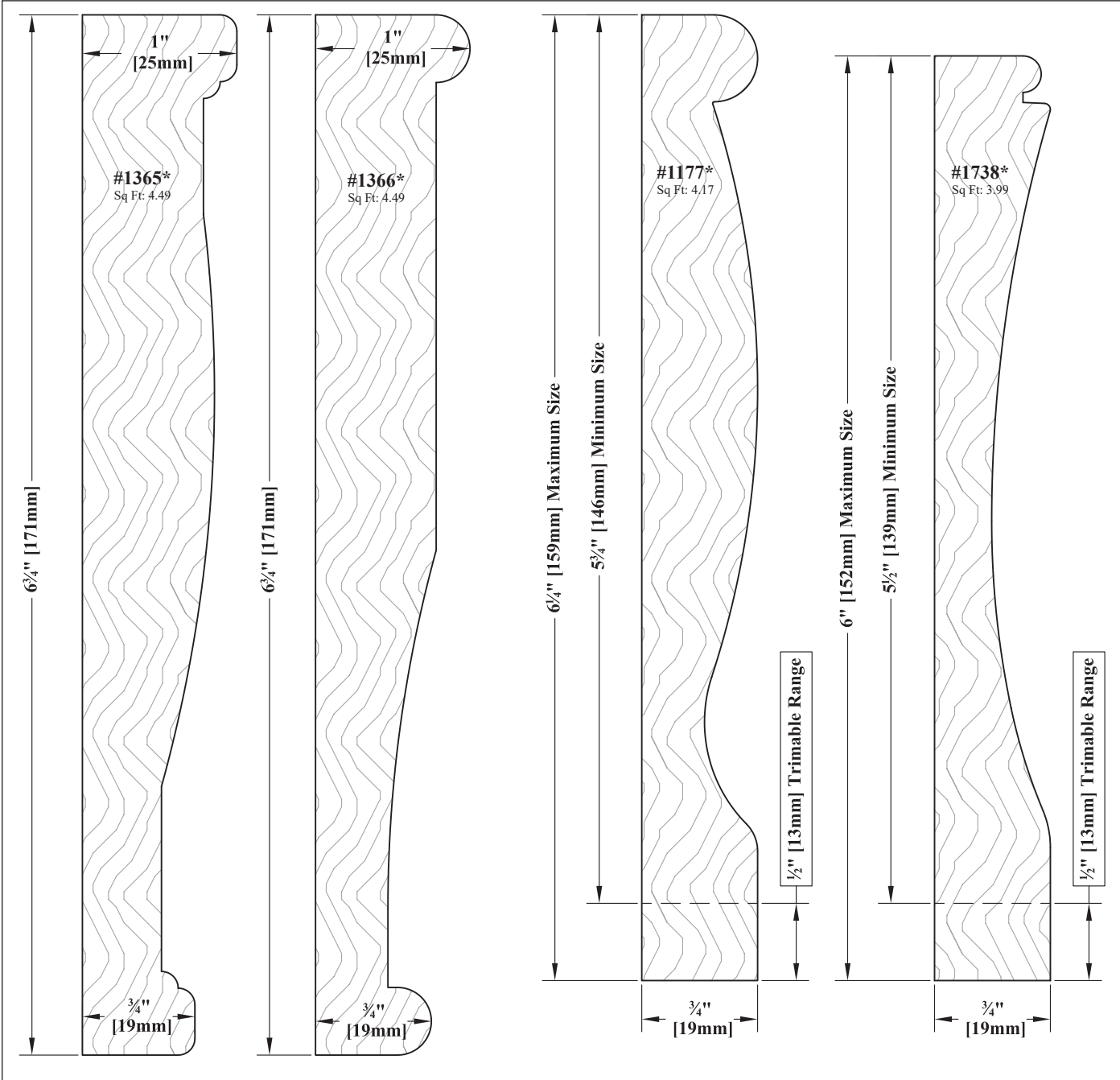

► For PRICING ► See Section B.17 in our current Wholesale Pricing Catalog.

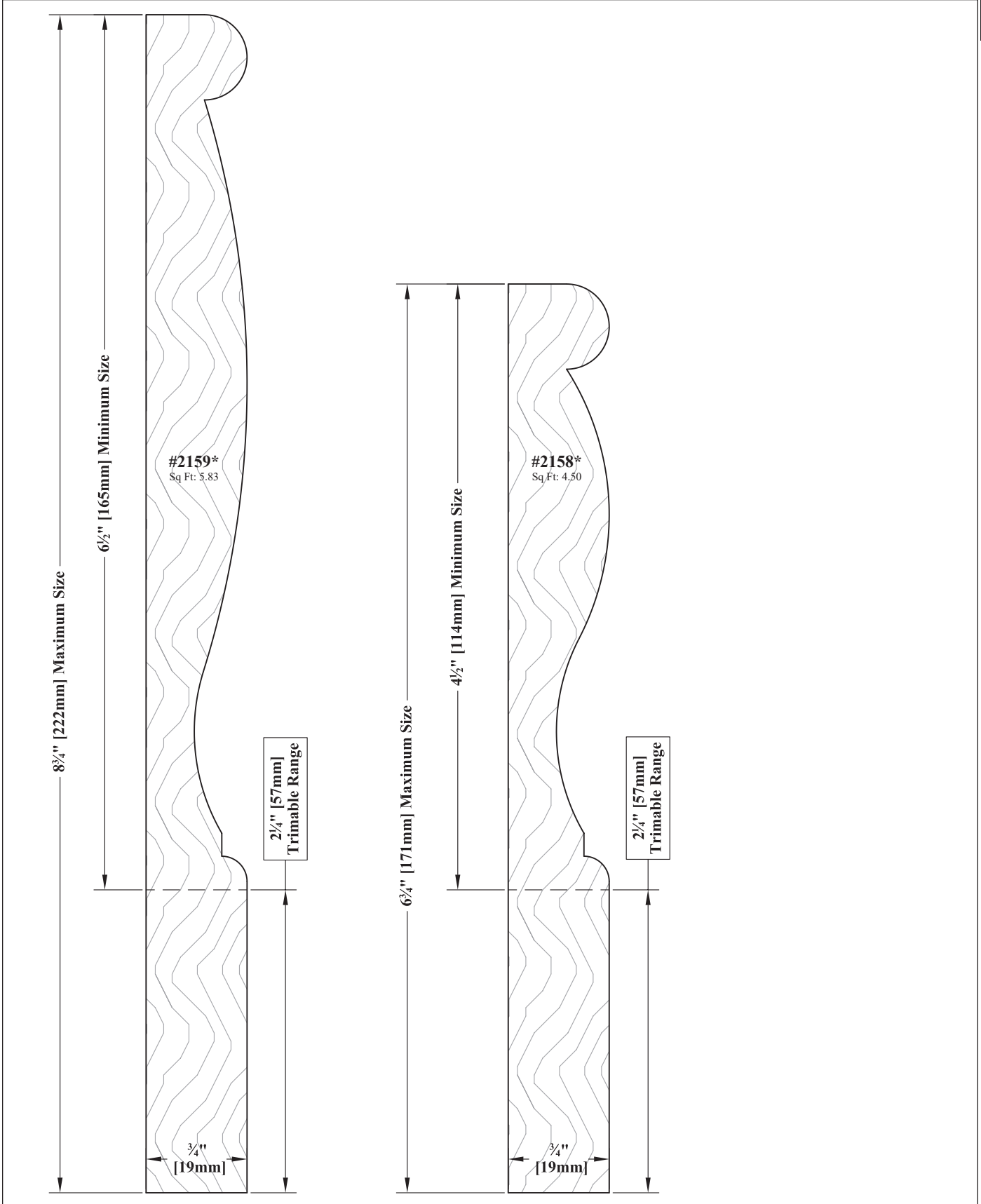

► For PRICING ► See Section B.17 in our current Wholesale Pricing Catalog.

Onlay Frames

An **Onlay Frame** is a frame with no panel cut that simulates a frame only door that can be applied to the backs of islands or peninsulas or on cabinet ends, or placed on walls to create a custom wainscot panel look. They come  $\frac{3}{8}$ " [9.5mm] thick, and use the same construction methods as that of our Mitered and French Mitered doors.

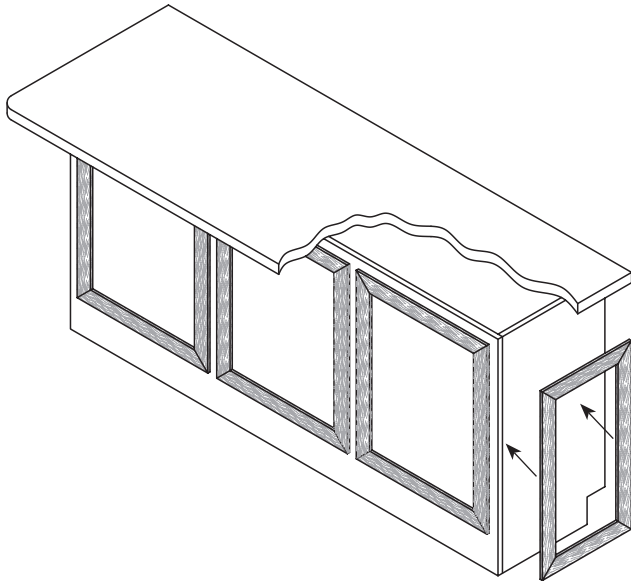

Shown with MP603-57

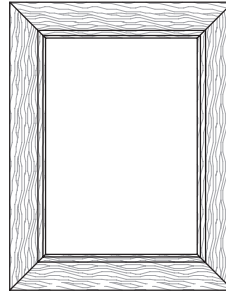

**Style: 10M-ONLAY**  
 PC: 301  
 Frame: PC301 x 0.6  
 Min. Size:  $5\frac{1}{2}$ x $5\frac{1}{2}$   
 [139.7mm x 139.7mm]

Shown with MP604-76

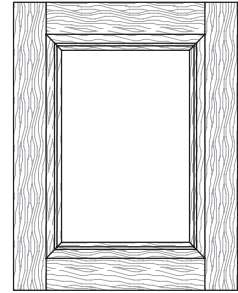

**Style: 10FM-ONLAY**  
 PC: 301  
 Frame: PC301 x 0.6  
 Min. Size: See Notes

*Example: Cross section of Style 10M-ONLAY shown with the MP609-57. (Drawn at a scale of 1:2)*

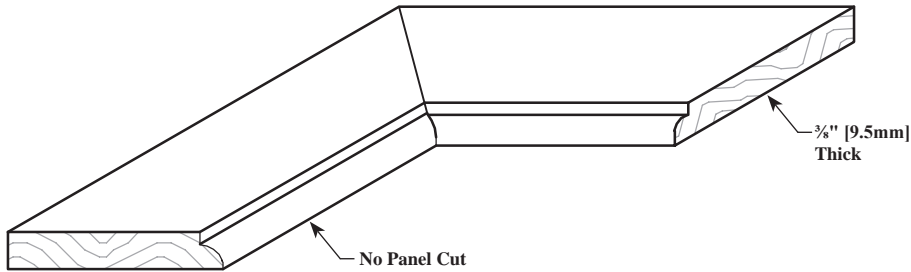

Continued on next page...

► For PRICING ► See Section [B.18](#) in our current Wholesale Pricing Catalog.

**Ordering & Pricing Notes: Onlay Frames**

**Ordering Guidelines**

1	Order Forms	Please use <i>Door Order Form (E•Z Form #2)</i> .
<b>Pricing</b>		
1	Pricing	Please see <i>Section B.18</i> of our current <b>Wholesale Pricing Catalog</b> .

**Technical Notes: Onlay Frames**

**Cabinet Door & Drawer Front Options (Chapter B)**

1	Door Styles	Available as a <b>Style 10M-ONLAY</b> Frame and <b>Style 10FM-ONLAY</b> Frame only.
---	-------------	---

**Finish Options (Chapter R)**

1	Finishing	Available with all WalzCraft standard finish options.
2	3D Laminate	Not available with 3D Laminate (RTF).

**Functional Options (Chapter F)**

1	Hinge Boring	Hinge boring is not available for Onlay Frames.
---	--------------	---

**Material Options**

1	Material	Onlay Frames are only available in solid wood.
---	----------	--

**Profile Options (Chapter E)**

1	Stile & Rail Profiles	<p><b>Style 10M-ONLAY</b> frames are 3/8" thick and available with all <b>MP600/MP6000</b> Mitered stile &amp; rail profiles.</p> <p><b>Style 10FM-ONLAY</b> frames are 3/8" thick and available with many of our <b>MP600/MP6000</b> Mitered stile &amp; rail profiles.</p> <ul style="list-style-type: none"> <li>Any <b>MP600/MP6000</b> profile number that has a corresponding <b>[FM]</b> symbol is available with French Miter construction for the <b>Style 10FM-ONLAY</b> frame.</li> </ul>
2	Outside Edge Profiles	Available with the <b>D7, D32</b> and <b>D33</b> outside edge profiles.

**Sizes/Dimensions**

1	Thickness	<p>Available 3/8" [9.5mm] thick.</p> <p>For 3/4" or 1" thick frames with no panel cut, please see <i>Section B.8 No-Panel Cut Frame Only Doors</i>.</p>
2	Stile & Rail Widths	<p>Stiles &amp; rails are available in widths from 1 1/2" [38.1mm] to 3" [76mm].</p> <p><b>Style 10FM-ONLAY</b> doors using French Miter construction will have the stiles &amp; rails finish at the exact width specified. There will be <b>no</b> width reduction due to the French Miter manufacturing process.</p>
3	Minimum Size	<p><b>Style 10M-ONLAY:</b> Minimum size is based on 2 1/4" [57.2mm] wide stiles and rails.</p> <ul style="list-style-type: none"> <li>The minimum frame opening is 1"W x 1"H [25.4mm x 25.4mm].</li> </ul> <p><b>Style 10FM-ONLAY:</b> Please see <i>Section B.7</i> for French Miter construction minimums.</p> <ul style="list-style-type: none"> <li>The minimum height for a frame opening with French Miter construction is 3 3/8" [85.7mm].</li> <li>The minimum length for a rail on a door using French Miter construction is 5 1/2" [139.7mm].</li> </ul>
4	Maximum Size	The maximum size for any Onlay Frame is 36" x 72" [914.4mm x 1828.8mm].

**Onlay Frames - END**

► For PRICING ► See Section **B.18** in our current Wholesale Pricing Catalog.

Peak Style Pyramid (Center Panel Profile PR600)

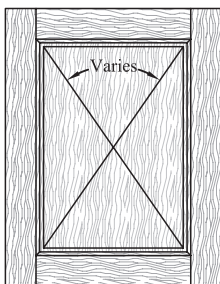

**Door Style: 10**  
**Min. Frame Opening: 6x7**  
 [152.4mm x 177.8mm]  
*Shown with height greater than width.*

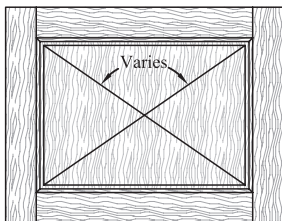

**Door Style: 10**  
**Min. Frame Opening: 7x6**  
 [177.8mm x 152.4mm]  
*Shown with width greater than height.*

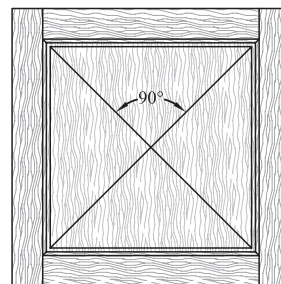

**Door Style: 10**  
**Min. Frame Opening: 6x6**  
 [152.4mm x 152.4mm]  
*Shown with width equal to height.*

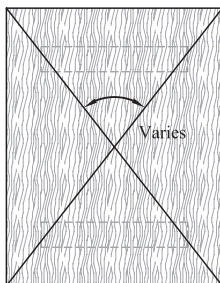

**Door Style: 1272**  
**Min. Door Size: 6x7**  
 [152.4mm x 177.8mm]  
*Shown with height greater than width.*

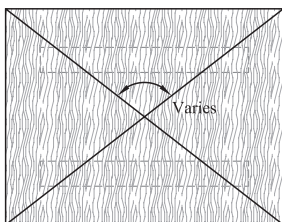

**Door Style: 1272**  
**Min. Door Size: 7x6**  
 [177.8mm x 152.4mm]  
*Shown with width greater than height.*

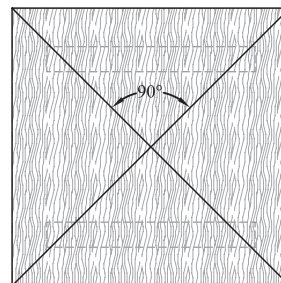

**Door Style: 1272**  
**Min. Door Size: 6x6**  
 [152.4mm x 152.4mm]  
*Shown with width equal to height.*

Ridgeline Style Pyramid (Center Panel Profile PR700)

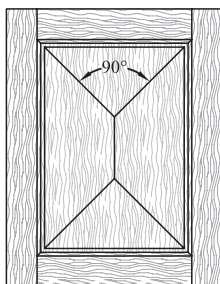

**Door Style: 10**  
**Min. Frame Opening: 6x7**  
 [152.4mm x 177.8mm]  
*Shown with height greater than width.*

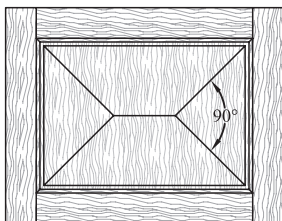

**Door Style: 10**  
**Min. Frame Opening: 7x6**  
 [177.8mm x 152.4mm]  
*Shown with width greater than height.*

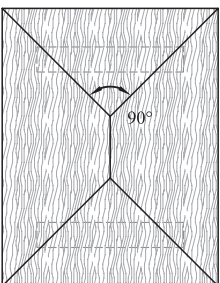

**Door Style: 1272**  
**Min. Door Size: 6x7**  
 [152.4mm x 177.8mm]  
*Shown with height greater than width.*

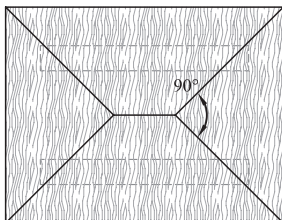

**Door Style: 1272**  
**Min. Door Size: 7x6**  
 [177.8mm x 152.4mm]  
*Shown with width greater than height.*

► For PRICING ► See Section B.19 in our current Wholesale Pricing Catalog.

Pyramid Center Panel Door & Drawer Front

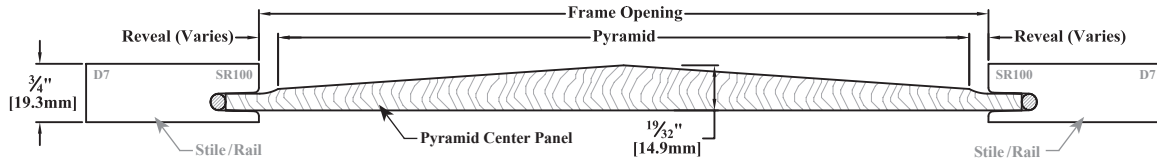

Pyramid Slab Door & Drawer Front

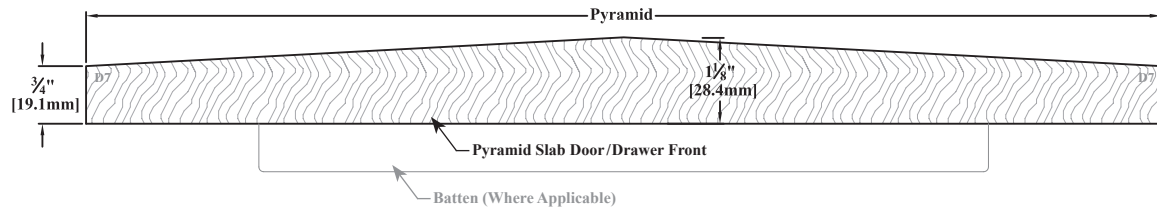

Ordering & Pricing Notes: Pyramid Panel Doors & Drawer Fronts

Ordering Guidelines

1	Order Forms	Please use <i>Door and/or Drawer Front Order Forms (E-Z Forms #2 and #3)</i> .
2	Peak Style Pyramid (Center Panel Profile PR600)	Indicate "PR600" in space provided for <b>Panel Profile</b> on order form. <ul style="list-style-type: none"> <li>• When the pyramid panel width and height are equal, the angles of the pyramid will be fixed at 45°/90°.</li> <li>• When the pyramid panel width and height are not equal, the angles of the pyramid will vary.</li> </ul>
3	Ridgeline Style Pyramid (Center Panel Profile PR700)	Indicate "PR700" in space provided for <b>Panel Profile</b> on order form. <ul style="list-style-type: none"> <li>• Angles of pyramid will be fixed at 45°/90°.</li> <li>• In order to achieve the Ridgeline look, the pyramid panel width and height cannot be equal.</li> </ul>

Pricing

1	Pricing	Please see <i>Section B.19</i> of our current <b>Wholesale Pricing Catalog</b> .
---	---------	--

Technical Notes: Pyramid Panel Doors & Drawer Fronts

General Information (Chapter A)

1	Grain Direction	See <i>Section A.4</i> for information on panel grain direction.
2	Ready to Assemble (RTA)	Available where applicable as noted in individual doors sections throughout <i>Chapter B</i> .
3	Warranties	All standard warranties for raised panel and solid slab doors and drawer fronts apply. See <i>Section A.8</i> for more information.

Cabinet Door & Drawer Front Options (Chapter B)

1	Frame & Panel Doors	Pyramid panels are available in doors and drawer fronts with square or rectangular center panel openings.
2	Slab & Batten Doors	Style 1272 and 1272* are available as pyramid panels.
3	RP Drawer Fronts	RP (Raised Panel) drawer fronts with Look "B" are available as pyramid panels.

Passageway Door Options (Chapter C)

1	Passageway Doors	Pyramid panels are available in doors with square or rectangular center panel openings.
---	------------------	---

Continued on next page...

► For PRICING ► See Section B.19 in our current Wholesale Pricing Catalog.

**Technical Notes: Pyramid Panel Doors & Drawer Fronts...continued**

**Profile Options (Chapter E)**

1	<b>Stile &amp; Rail Profiles</b>	Available where applicable as noted in <i>Chapter E</i> for doors and drawer fronts utilizing pyramid center panels, excluding those with a 4.0mm or 6.9mm panel plow groove cut placement.
2	<b>S/R - AM - Inside Edge</b>	Please submit requests to our Customer Support Team.
3	<b>S/R - AM - Shelf Applied</b>	Please submit requests to our Customer Support Team.
4	<b>S/R - AM - Face Applied</b>	Available where applicable as noted in <i>Section E.6</i> .
5	<b>Center Panel Profiles</b>	Pyramid panels are only available with <b>PR600</b> or <b>PR700</b> as shown in this section.
6	<b>Outside Edge Profiles - Standard</b>	Available where applicable as noted in <i>Section E.15</i> for doors and drawer fronts utilizing pyramid center panels.
		Pyramid slab doors and drawer fronts are only available with <b>D7</b> or <b>D33</b> .
7	<b>Outside Edge Profiles - AM</b>	Available where applicable as noted in <i>Section E.16</i> for doors and drawer fronts utilizing pyramid center panels.
		Pyramid slab doors and drawer fronts are not available with outside edge applied molding profiles.

**Material Options**

1	<b>Solid Wood</b>	Pyramid panel doors and drawer fronts are only available in solid wood.
---	-------------------	---

**Sizes/Dimensions**

1	<b>Minimum Size</b>	<b>Pyramid Center Panel Doors &amp; Drawer Fronts:</b> Doors and drawer fronts utilizing pyramid center panels have a minimum panel opening size of 6"W [152.4mm] x 6"H [152.4mm].
		<b>Pyramid Slab Doors and Drawer Fronts:</b> Pyramid slab doors and drawer fronts have a minimum size of 6"W [152.4mm] x 6"H [152.4mm].
2	<b>Maximum Size</b>	<b>Pyramid Center Panel Doors &amp; Drawer Fronts:</b> Doors and drawer fronts utilizing pyramid center panels have a maximum panel opening size of 25 $\frac{3}{8}$ "W [650.9mm] x 25 $\frac{3}{8}$ "H [650.9mm].
		<b>Pyramid Slab Doors and Drawer Fronts:</b> Pyramid slab doors and drawer fronts have a maximum size of 26 $\frac{1}{2}$ "W [673.1mm] x 26 $\frac{1}{2}$ "H [673.1mm].
3	<b>Thicknesses</b>	When using Traditional stile and rail profiles, Pyramid center panel doors and DFs made from solid wood are available $\frac{3}{4}$ " [19.3mm] and 1" [25.4mm] thick.
		When using Old World stile and rail profiles, Pyramid center panel doors and DFs made from solid wood are available 1" [25.4mm], 1 $\frac{1}{8}$ " [28.6mm] and 1 $\frac{1}{4}$ " [31.8mm] thick.
		Pyramid slab doors and drawer fronts are only available 1 $\frac{1}{8}$ " thick. See <i>Section S.3</i> for possible thickness restrictions based on wood species.

**Wood Species Options (Chapter S)**

1	<b>Wood Species</b>	Available with all solid wood species noted in <i>Sections B.1, B.5, B.9</i> and <i>B.16</i> (excluding Rustic and Knotty grades).
---	---------------------	--

**Pyramid Panel Doors and Drawer Fronts - END**

► For PRICING ► See Section **B.19** in our current Wholesale Pricing Catalog.

Nexus Door & Drawer Front

B

Style: NX62\*  
Drawer Front  
Shown w/ NP401

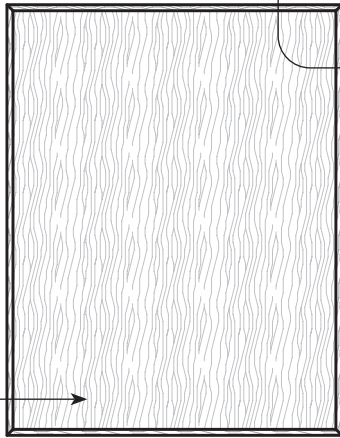
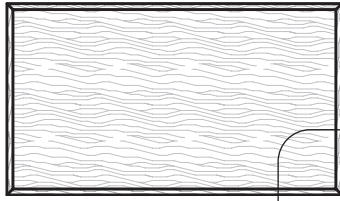

Style: NX62  
Shown w/ NP401

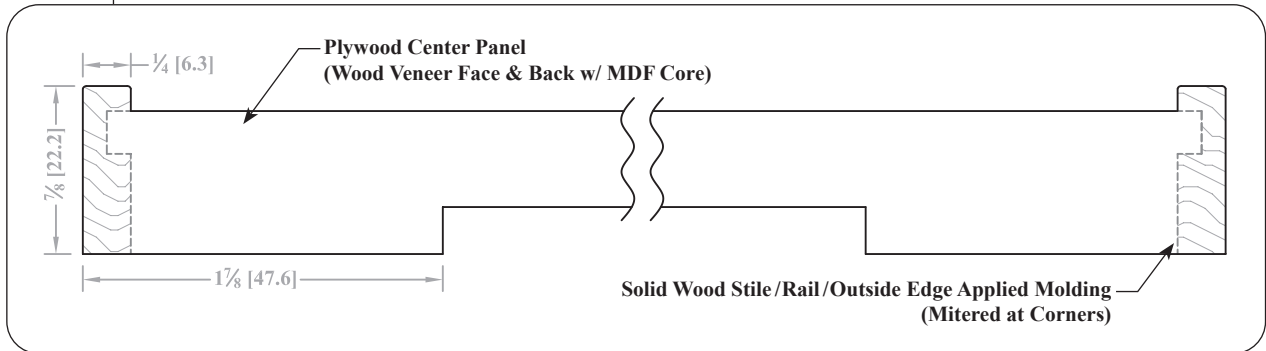
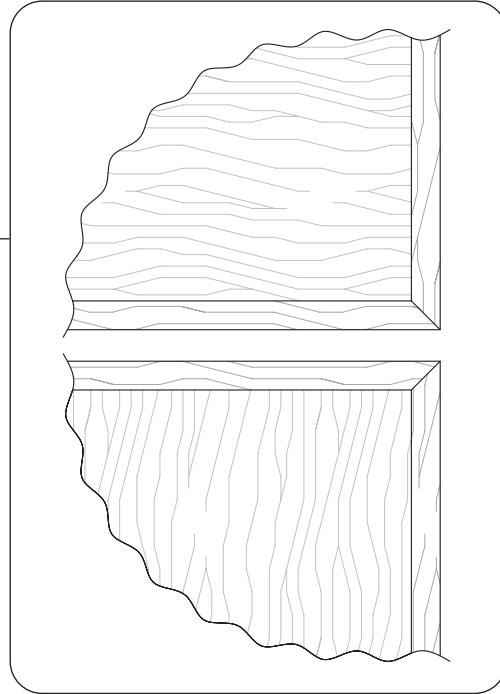

Continued on Next Page...

► For PRICING ► See Section B.20 in our current Wholesale Pricing Catalog.

Nexus Door & Drawer Front Profiles

NP401 PC: 03 Min. Size: 6" x 6" [152.4mm x 152.4mm]

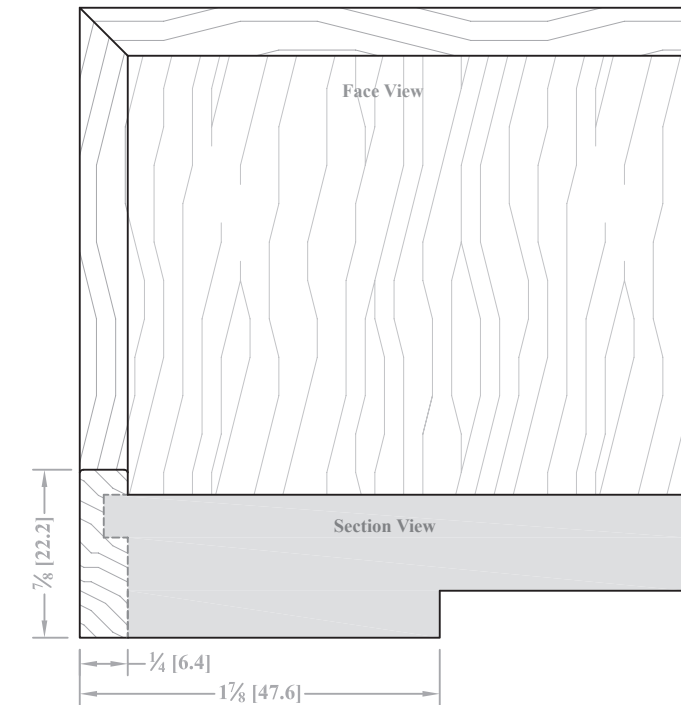

NP411 PC: 02 Min. Size: 6" x 6" [152.4mm x 152.4mm]

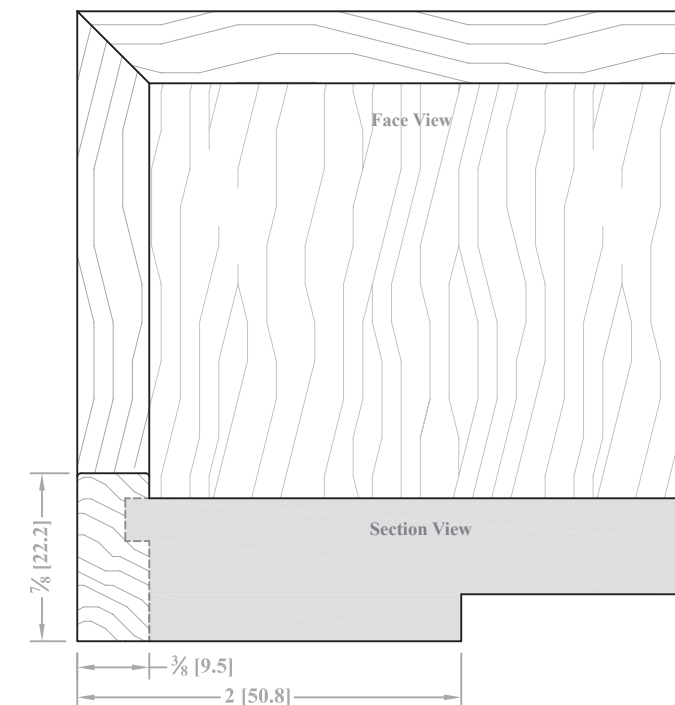

NP402 PC: 02 Min. Size: 6" x 6" [152.4mm x 152.4mm]

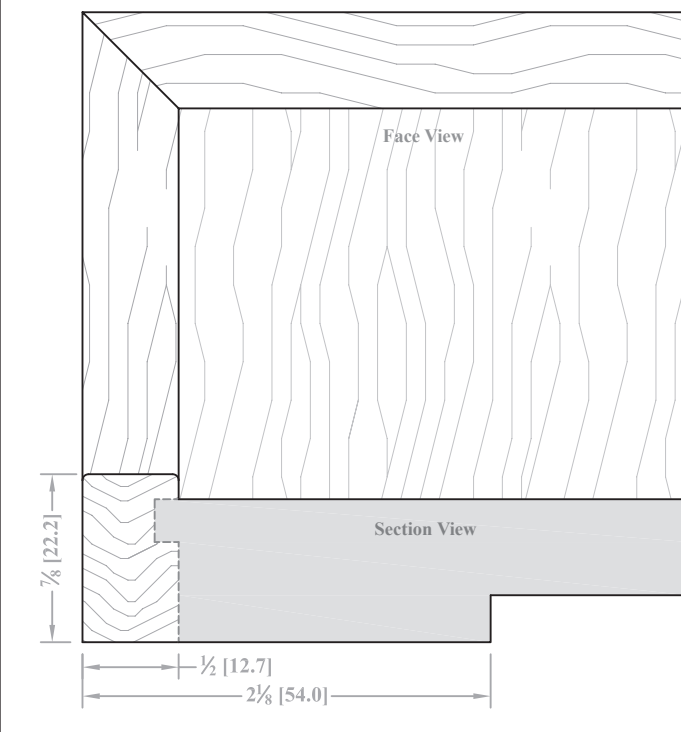

NP403 PC: 01 Min. Size: 6" x 6" [152.4mm x 152.4mm]

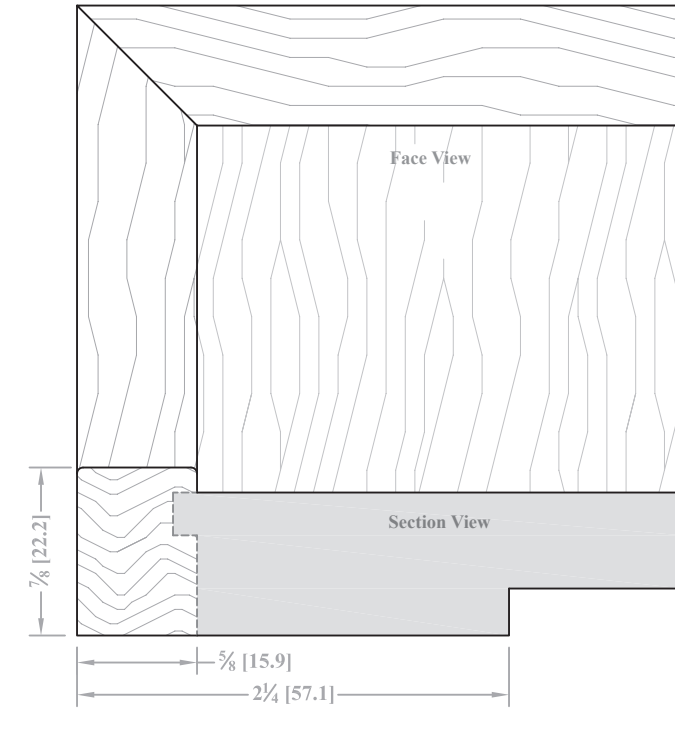

Continued on Next Page...

► For PRICING ► See Section [B.20](#) in our current Wholesale Pricing Catalog.

Nexus Door & Drawer Front Profiles...continued

B

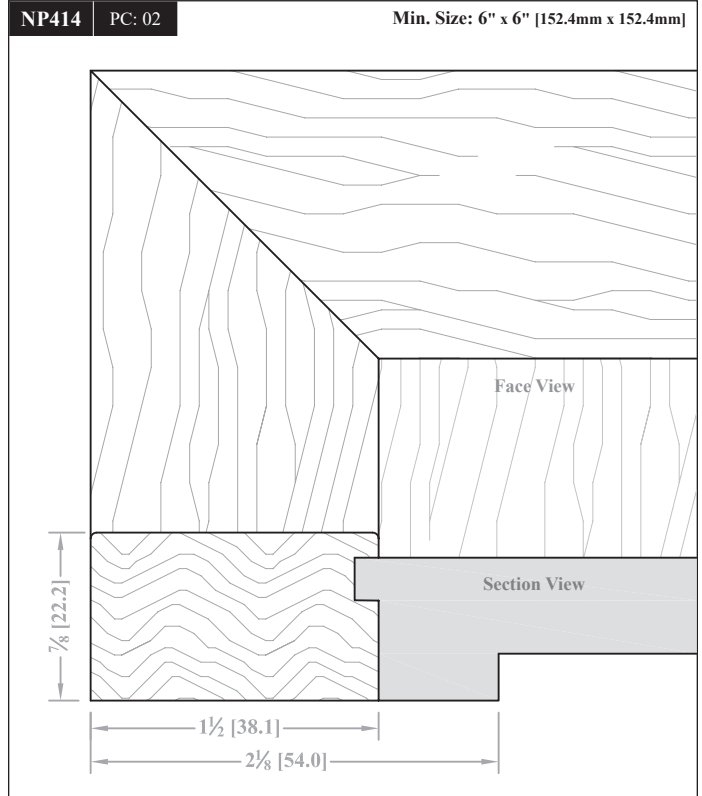
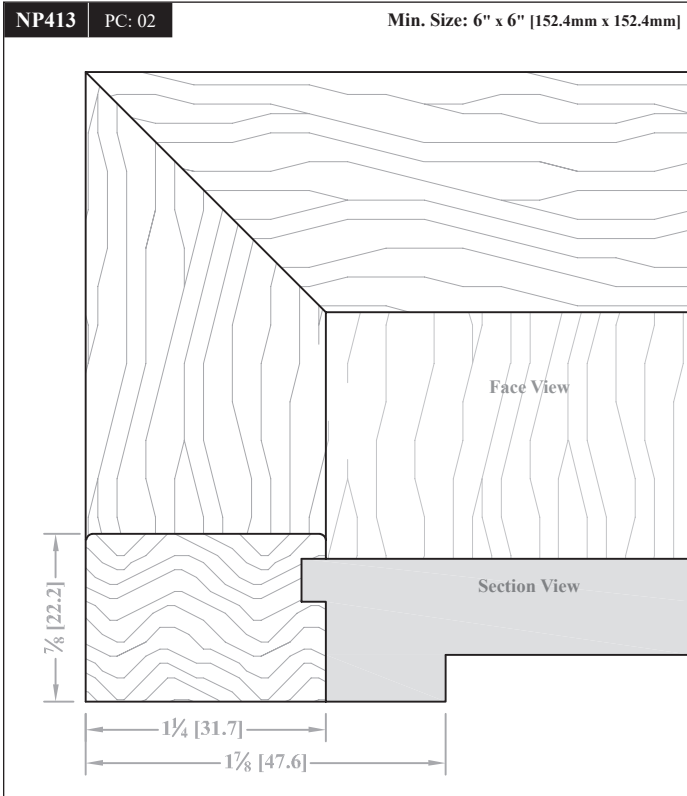
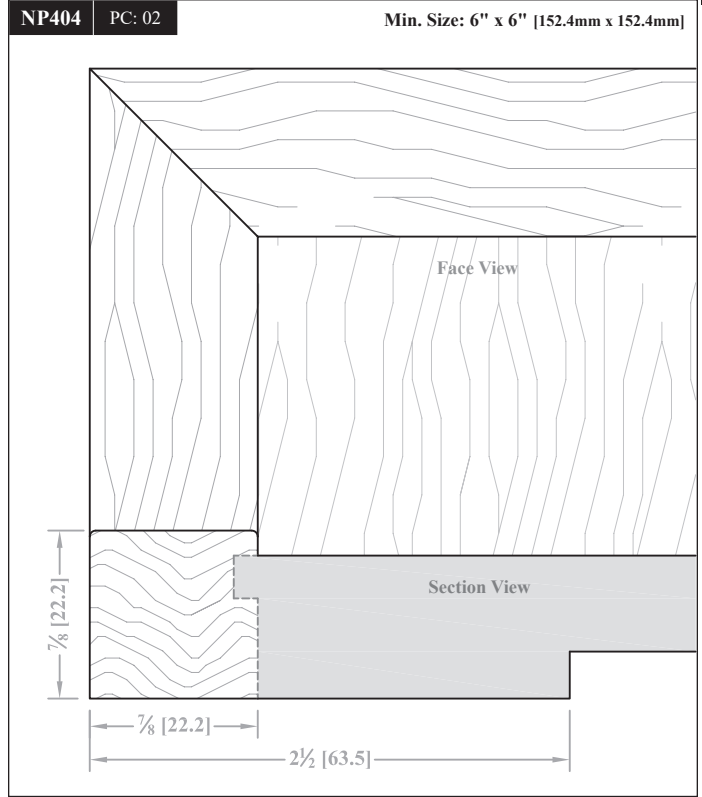
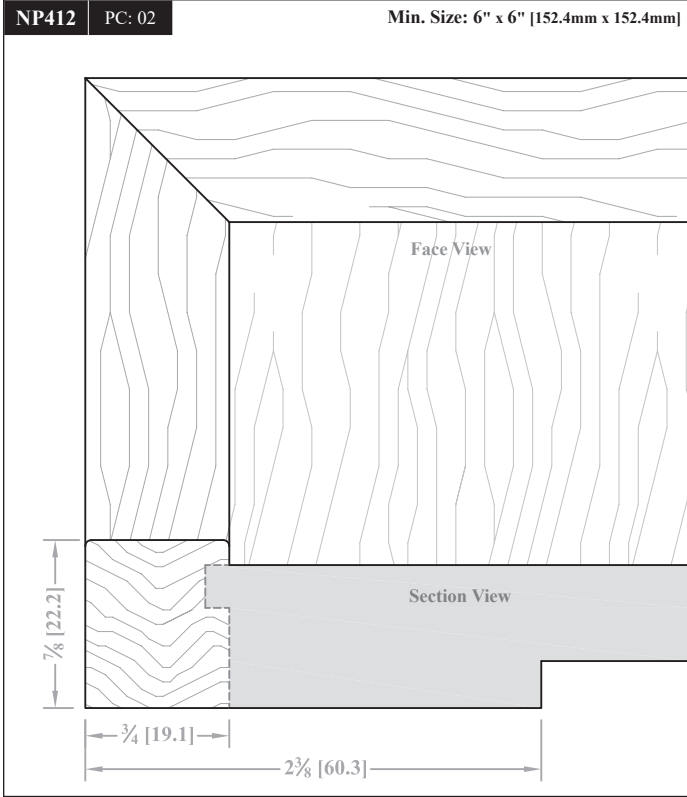

Continued on Next Page...

► For PRICING ► See Section [B.20](#) in our current Wholesale Pricing Catalog.

Nexus Door & Drawer Front Profiles...continued

NP407 PC: 03 Min. Size: 6" x 6" [152.4mm x 152.4mm]

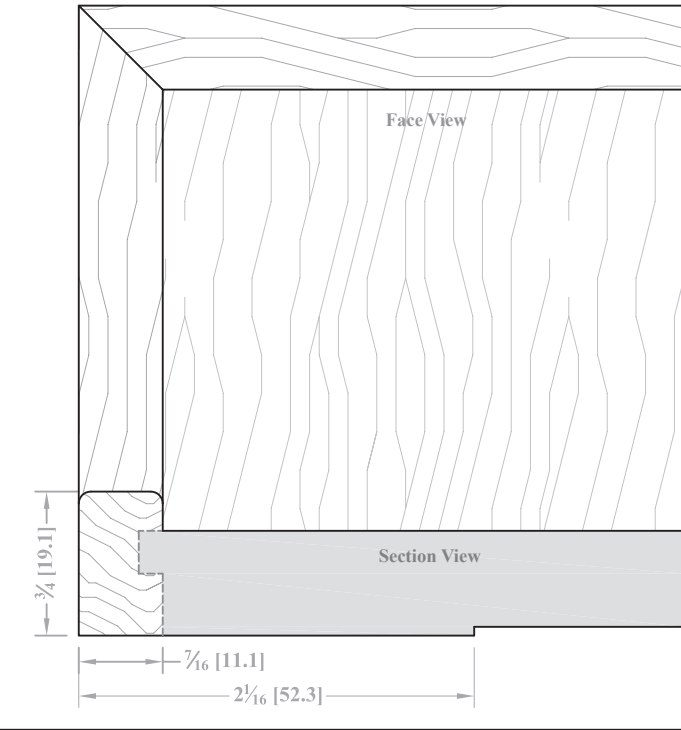

NP408 PC: 04 Min. Size: 6" x 6" [152.4mm x 152.4mm]

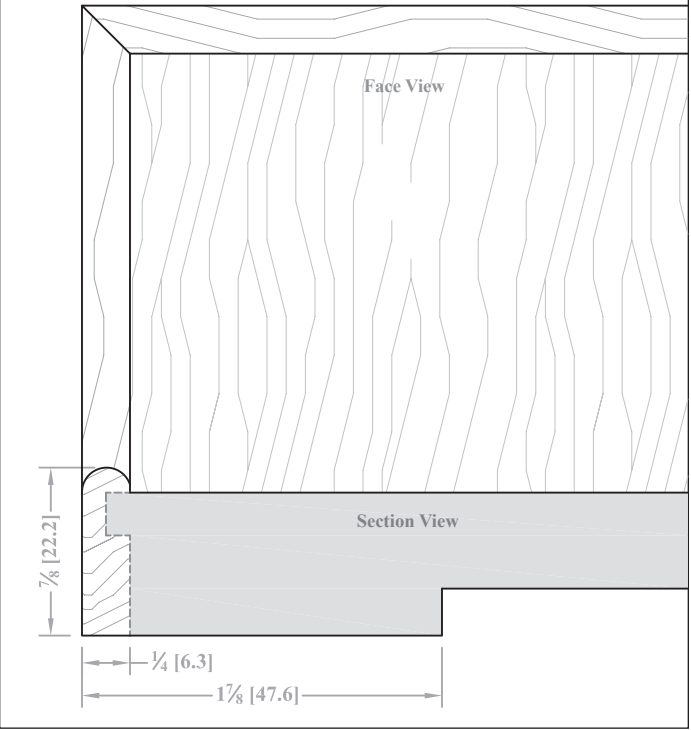

NP409 PC: 03 Min. Size: 6" x 6" [152.4mm x 152.4mm]

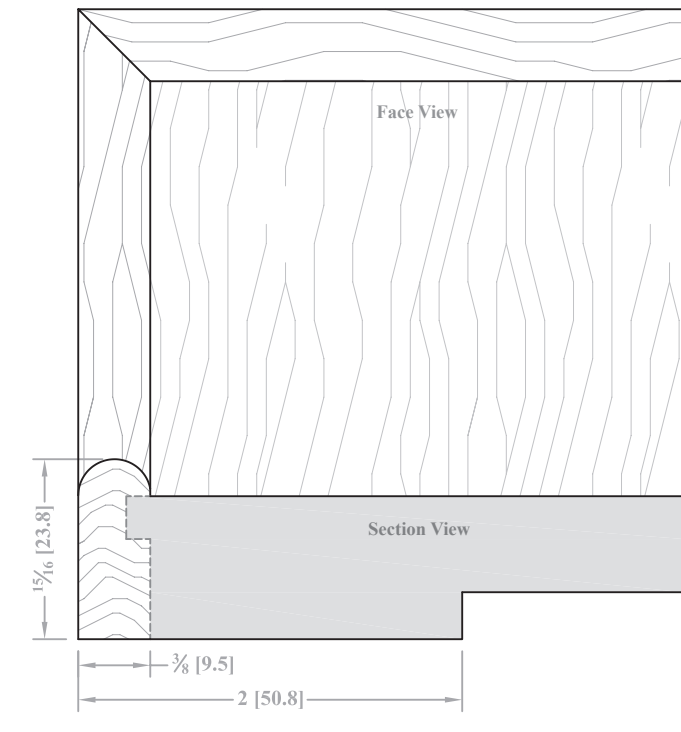

NP410 PC: 05 Min. Size: 6" x 6" [152.4mm x 152.4mm]

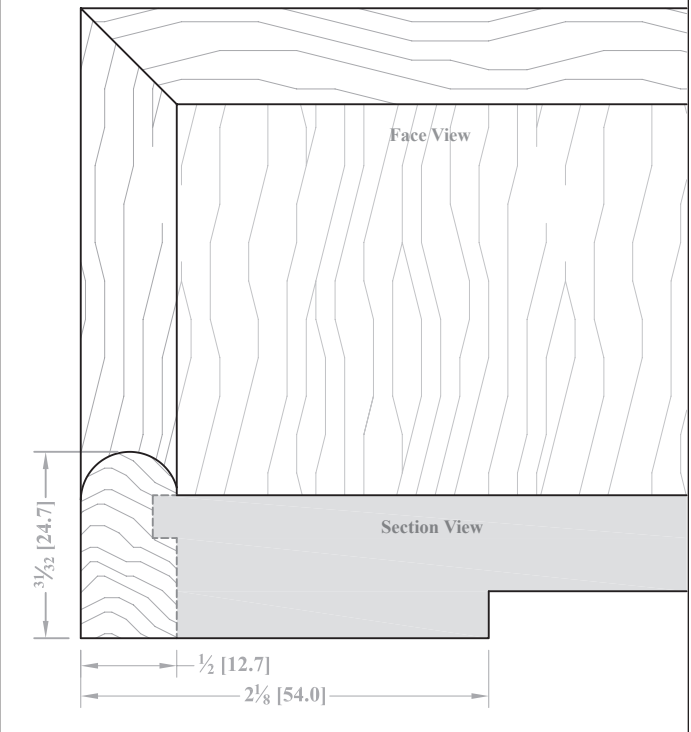

Continued on Next Page...

► For PRICING ► See Section **B.20** in our current Wholesale Pricing Catalog.

Nexus Door & Drawer Front Profiles...continued

B

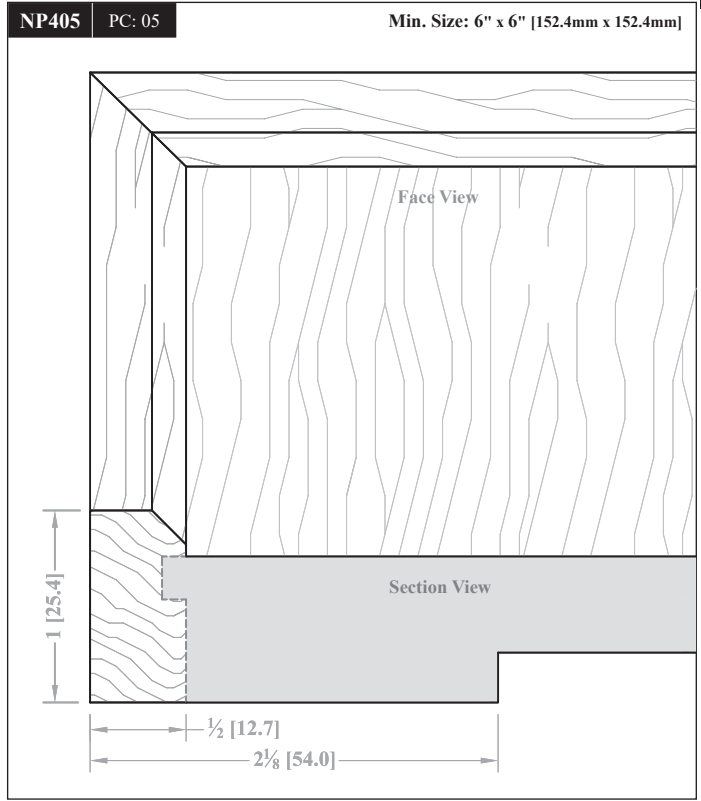
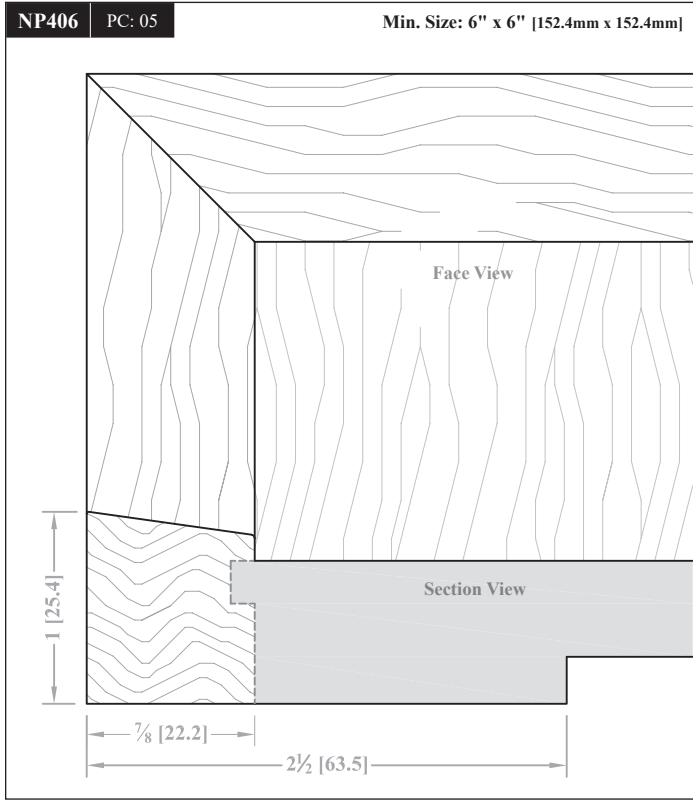

Continued on Next Page...

► For PRICING ► See Section [B.20](#) in our current Wholesale Pricing Catalog.

Nexus Doors with Reeded Applied Molding Options

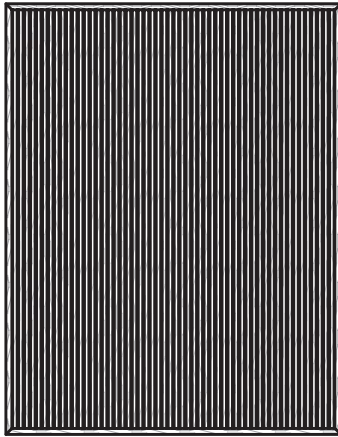

Style: NX62  
Shown w/ NP502 and  
Reeded Applied Molding #3241

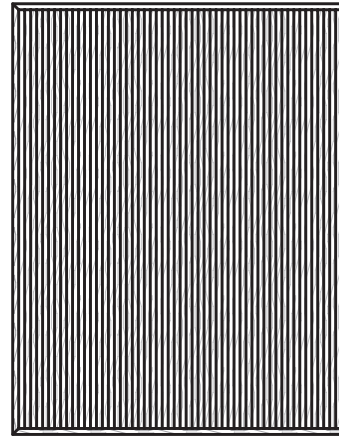

Style: NX62  
Shown w/ NP502 and  
Reeded Applied Molding #3215

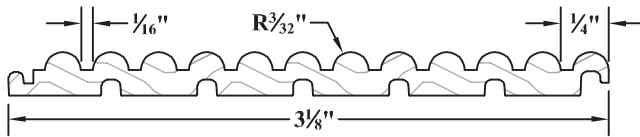

#3241  
PC: M102  
Sq Ft: 2.08

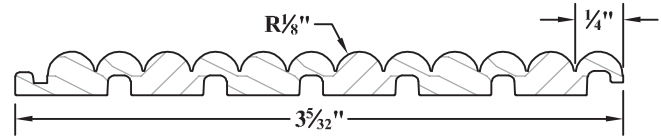

#3215  
PC: M102  
Sq Ft: 2.11

NP502 PC: 04

Shown w/ #3241

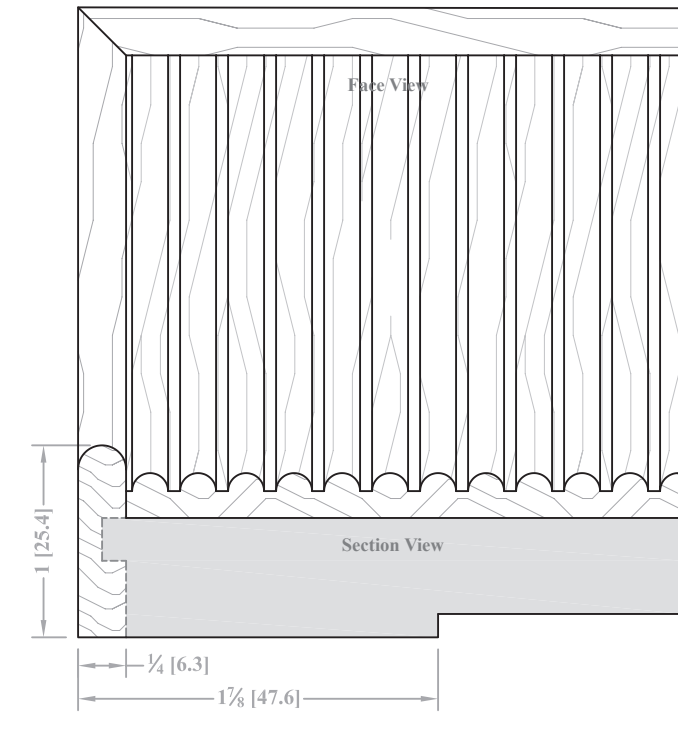

NP502 PC: 04

Shown w/ #3215

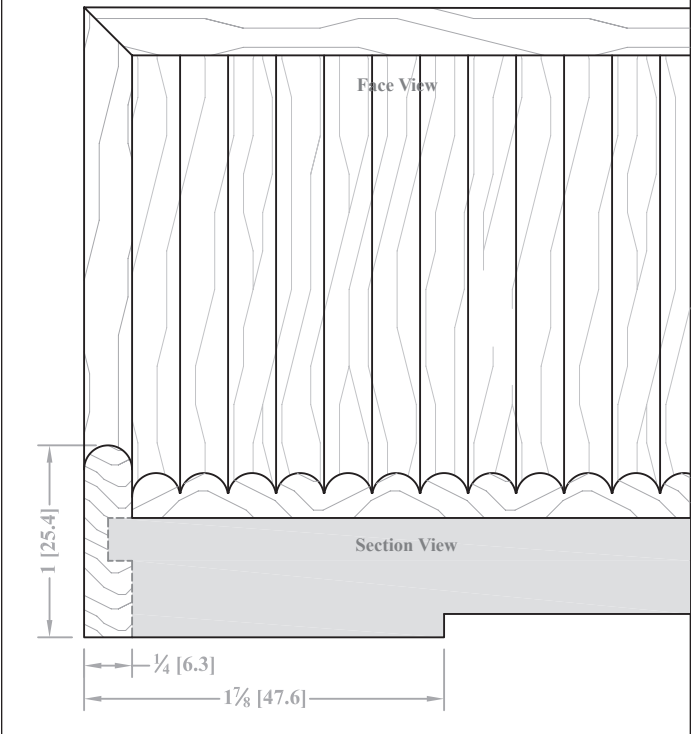

Continued on Next Page...

► For PRICING ► See Section [B.20](#) in our current Wholesale Pricing Catalog.

Nexus Profiles for Reeded Applied Molding #3241

Nexus Profiles for Reeded Applied Molding #3215

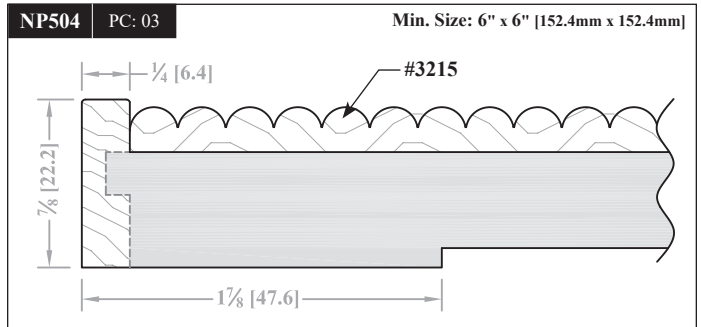
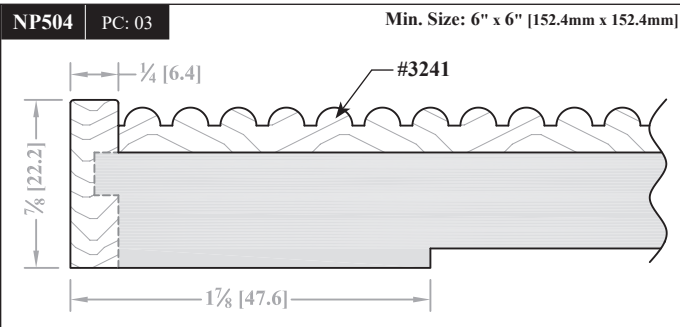
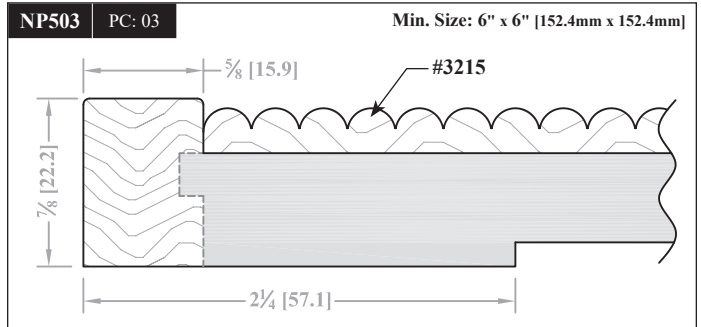
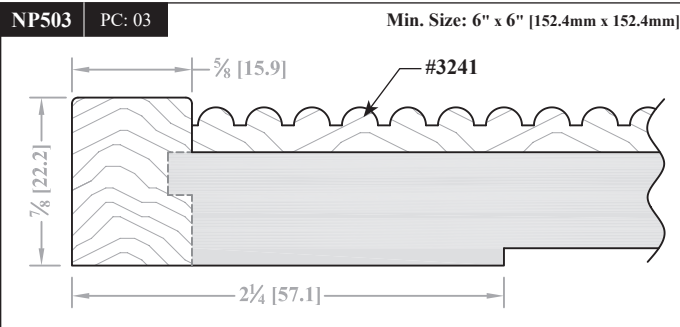
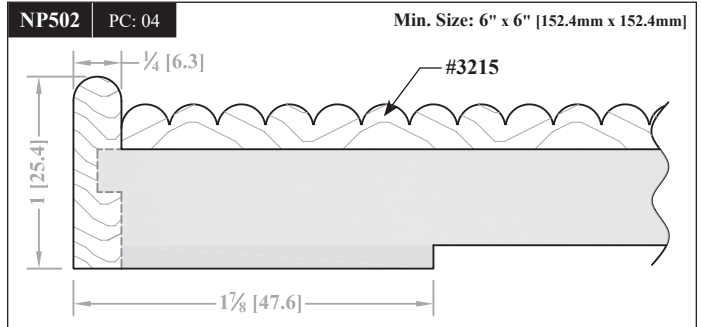
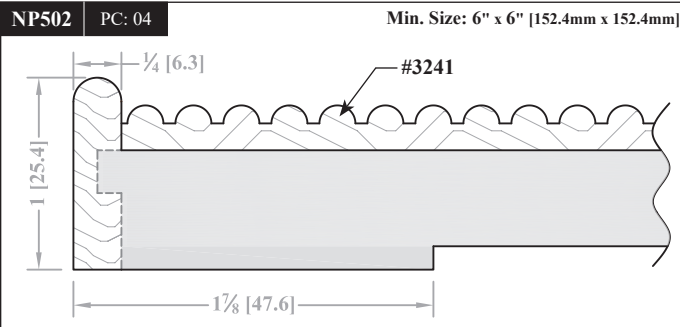
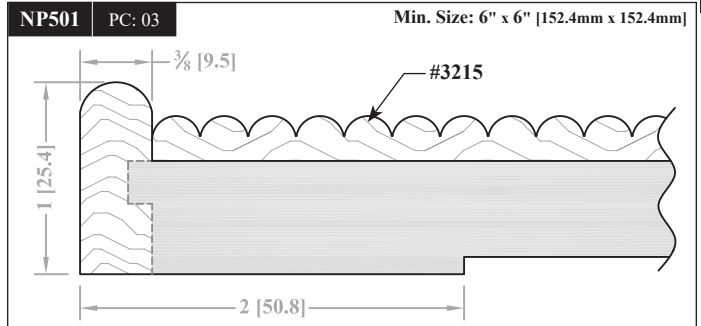
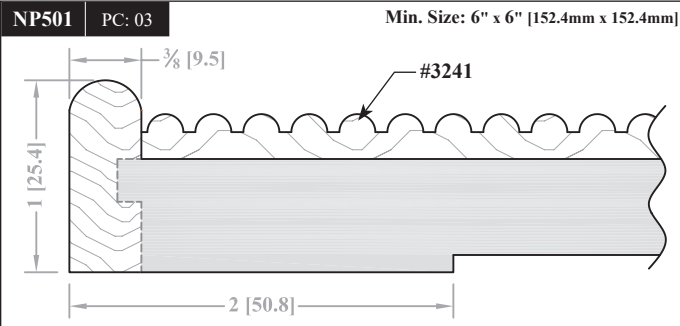

Continued on Next Page...

► For PRICING ► See Section [B.20](#) in our current Wholesale Pricing Catalog.

## Ordering &amp; Pricing Notes: Nexus Doors and Drawer Fronts

## Ordering Guidelines

1	Order Forms	Please use <i>Nexus Door and Drawer Front Order Form (E•Z Form #7.1)</i> .
2	Ordering Information	When ordering, please specify: <ul style="list-style-type: none"> <li>• Door Style <b>NX62</b> and/or Drawer Front Style <b>NX62*</b>.</li> <li>• Nexus profile (ex: <b>NP401</b>).</li> <li>• Center panel wood species/grade and grain direction.</li> <li>• Stile/rail/molding wood species/grade.</li> <li>• When choosing a reeded applied molding for the face, also indicate the reeded applied molding number (ex: <b>#3241, #3215</b>), the reeded applied molding wood species/grade and the direction/placement of the molding. <ul style="list-style-type: none"> <li>◦ Vertical (top to bottom) or horizontal (left to right).</li> </ul> </li> </ul>
<b>Pricing</b>		
1	Pricing	Please see <i>Section B.20</i> of our current <b>Wholesale Pricing Catalog</b> .

## Technical Notes: Reeded Applied Molding Door

## General Information (Chapter A)

1	Grain Direction	Center panel grain direction must be specified (vertical or horizontal).
2	Ready to Assemble	Nexus doors and drawer fronts are not available Ready to Assemble ( <b>RTA</b> ).
3	Warranties	All standard warranties for MDF products apply. See <i>Section A.8</i> for more information.

## Profile Options (Chapter E)

1	Reeded Applied Molding	Reeded applied molding <b>#3241</b> and <b>#3215</b> are only available with Nexus profiles <b>NP501, NP502, NP503</b> and <b>NP504</b> . Nexus profiles <b>NP501, NP502, NP503</b> and <b>NP504</b> are only available when combined with reeded applied molding <b>#3241</b> or <b>#3215</b> .
---	------------------------	---

## Functional Options (Chapter F)

1	Hinge Boring	Only available with 35mm hinge boring. <ul style="list-style-type: none"> <li>• <b>NP407</b> is only available with our 12.7mm deep hinge boring option.</li> <li>• See <i>Section F.1</i> for more information, including minimum stile and rail widths for hinge boring.</li> </ul>
2	Finger Pull Routs	Available with finger pull routs <b>FP100, FP200</b> and <b>FP500</b> , with the following exceptions: <ul style="list-style-type: none"> <li>• <b>FP200</b> not available with <b>NP407-52, NP501-51, NP502-48, NP504-48</b>.</li> <li>• <b>FP500</b> not available with <b>NP502-48, NP504-48</b>.</li> <li>• See <i>Section F.7</i> for more information on finger pull routs.</li> </ul>

## Design Options (Chapter G)

1	Distressing	Please submit your requests for distressing options for Nexus doors to our Customer Support Team.
---	-------------	---

## Finish Options (Chapter R)

1	Stain	Available with a Natural / Clear Coat ( <i>no stain</i> ) as well as all Wiping, Spray No-Wipe and Water Based Wiping stain options.
2	SolidTone®	Available with all SolidTone®, SolidTone® WoodGrain and Primed Only for Paint options.
3	Glaze, Rub Through	Please submit your requests for glazing and/or Rub Through options for Nexus doors to our Customer Support Team.

## Material Options

1	Center Panels	Nexus door center panels are made from ½" thick plywood (MDF core with wood veneer face & back), raw MDF or raw MDF-MR.
2	Stiles/Rails/Molding	Stiles/rails/outside edge applied molding will be made from solid wood mitered at the corners.

## Sizes/Dimensions

1	Nexus Doors Minimum Size	The minimum size for a Nexus door/df is listed with the image of the profile. <ul style="list-style-type: none"> <li>• Nexus profiles have fixed stile/rail widths that cannot be modified.</li> <li>• Requests for sizes below stated minimums should be submitted to our Customer Support Team.</li> </ul>
2	Nexus Doors with Reeded Applied Molding	When running the reeded applied molding vertically (top to bottom), the overall width of the door or drawer front will only be available in ¼" [6.4mm] increments. When running the reeded applied molding horizontally (left to right), the overall height of the door or drawer front will only be available in ¼" [6.4mm] increments.
3	Nexus Doors Maximum Sizes	<b>NP400 Series:</b> 36" [914.4mm] across the grain, 80" [2032.0mm] with the grain. <b>NP500 Series:</b> 28" [711.2mm] across the grain, 48" [1219.2] with the grain.
4	Thicknesses	Nexus doors and drawer fronts are only available in the thickness indicated within the individual profile drawings.

Nexus Doors and Drawer Fronts - END

► For PRICING ► See Section **B.20** in our current Wholesale Pricing Catalog.