



2248 Crown Molding
Cherry Wood - Java V2 Combination Stain



2246 Crown Molding
Cherry Wood - Honey Wiping Stain



1346 Crown Molding
Maple Wood - Eggshell SolidTone®

Molding - Table of Contents

Section Name	Page #
N1 • Crown Molding	N1-3
N2 • Refacing Molding	N2-1
• Refacing Molding	N2-1
• Solid Wood Refacing Stock	N2-3
N3 • Corner & Scribe Molding	N3-1
• Outside Corner Molding	N3-1
• Cove Molding	N3-1
• Base Shoe & Quarter Round Molding	N3-1
• Scribe Molding	N3-2
• 45° & 90° Transition Molding	N3-2
• 90° Corner Door Molding	N3-3
• Inside Corner Molding	N3-3
N4 • Base & Casing Molding	N4-1
N5 • Applied Molding	N5-1
• Applied Molding – Outside Edge	N5-1
• Applied Molding – Inside Edge, Shelf & Face	N5-2
• Old World Applied Molding – Inside Edge	N5-4
N6 • Mullion Stock Molding	N6-1
N7 • Column Molding	N7-1
• Half & Quarter Round Column Molding – Smooth	N7-1
• Half Round Column Molding – Reed	N7-1
• Half & Quarter Round Column Molding – Fluted	N7-2
• Beaded Column Molding – 1/4"	N7-3
• Beaded Column Molding – 3/8"	N7-4
• Elliptical Column Molding	N7-5
• Pyramid Column Molding	N7-5
• Reed Column Molding	N7-6
• Miscellaneous Column Molding	N7-6
• Round Column Wrap Molding - Smooth	N7-7
• Round Column Wrap Molding - Fluted	N7-10
N8 • Wainscot Molding	N8-1
• Wainscot Cap Molding	N8-1
• Wainscot Inside Edge Applied Molding	N8-2
• Wainscot Backband Molding	N8-2
N9 • Miscellaneous Molding	N9-1
• Color Block Molding	N9-1
• Door Jamb Stop Molding	N9-1
• Window Sill Molding	N9-1
• Astragal Molding	N9-1
• Louvered Slat Molding – Fixed	N9-2
• Louvered Slat Molding – Operable	N9-2
• Operable Louver Actuator Molding	N9-2
• Half Lap Molding	N9-2
• Panel Splice Molding	N9-2



2179 Canopy Molding
Cherry Wood - Fruitwood Wiping Stain
(# 942 Crown Molding Match Also Available)



2175 Canopy Molding
Maple Wood - Oatmeal SolidTone®
(# 1860 Crown Molding Match Also Available)

Molding - Table of Contents...continued

Section Name	Page #
N9 • Miscellaneous Molding...continued	N9-1
• Dowel Molding	N9-2
• Square Peg Molding	N9-2
• Beaded Molding	N9-3
• Inset Bead Molding	N9-3
• Miscellaneous Molding	N9-3
• Finger Pull Molding – 3/4" Thick Door	N9-4
• Finger Pull Molding – 5/8" Thick Door	N9-4
• Edgeband Molding	N9-4
• Countertop Edge Molding	N9-4
• Shelf Bull Nose Molding	N9-4
• Wood Retainer Molding	N9-5
• GRF Extension Molding	N9-6
• Chair Rail Molding	N9-6
• Retail Price Tag Molding	N9-6
• Drawer Guide Spacer Molding	N9-6
• Step Molding	N9-6
• Under & Over Cabinet Molding	N9-7
• Plate Rail Molding	N9-9
• Spice Rack Molding	N9-10
• Tiered Spice Drawer Molding	N9-10
• Drawer Box Divider Molding	N9-10
• Pencil Tray Molding	N9-10
• Bar Rail / Cap Molding	N9-11
• Mantel Molding	N9-12
• Frieze Molding	N9-12
• Plate Display Molding	N9-12
• Wine Rack Molding	N9-12
• Stemware Molding	N9-12
N10 • Canopy Styles/Molding	N10-1
• Canopy Styles	N10-1
• Canopy Molding	N10-3
N11 • Precision Molded Wood Flooring	N11-1
• 3/4" Wood Flooring	N11-1
• 3/4" Wood Flooring Transition Molding	N11-1
• 3/8" Wood Flooring	N11-2
• 3/8" Wood Flooring Transition Molding	N11-2
N12 • Molding Notes	N12-1
N13 • Outsourced Molding - Bead, Egg & Dart and Rope	N13-1
• Bead and Egg & Dart Molding	N13-1
• Rope Molding	N13-2

Moldings

Crown Molding

#1239
See Outsourced Moldings

#2249
PC: M101
Sq Ft: 2.98

#2250
PC: M101
Sq Ft: 2.98

#2251
PC: M101
Sq Ft: 2.98

#2265
PC: M101 + Assembly Fee
Sq Ft: 3.99
Two pieces, assembled by WalzCraft.

#2265
PC: M101 + Assembly Fee
Sq Ft: 3.99
Two pieces, assembled by WalzCraft.

#2266
PC: M101 + Assembly Fee
Sq Ft: 3.99
Two pieces, assembled by WalzCraft.

#2266
PC: M101 + Assembly Fee
Sq Ft: 3.99
Two pieces, assembled by WalzCraft.

#864
PC: M101
Sq Ft: 1.01

Mounting Plate

Dentil Moldings
Molding #'s 1238 and 1239 can be applied to all of these crown moldings.

#1238
See Outsourced Moldings

#958
FRC
Face Frame
Drawing not to scale.

FRC = Fastener Relief Cut

Spring Angle

38°

FRC = Fastener Relief Cut. = Available for Convex/Concave products. ★ = Available with 3D Laminate/RTF.

► For PRICING ► See Section N1 in our Wholesale Pricing Catalog.

Crown Molding

Moldings

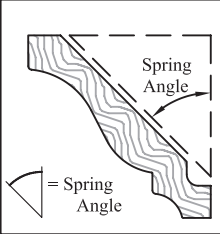

Dentil Molding

The #2247 Crown Molding is designed to accept these moldings: #829, #809, #810, #238, #239, #831 or #832 moldings, for use as Dentil Moldings.

#2247
PC:M101
Sq Ft: 2.80

#2270
PC: M101 + Assembly Fee
Sq Ft: 3.81
Two pieces, assembled by WalzCraft.

#829
See Outsourced Moldings

#2270

(2247)

(864)

#2599
PC:M101
Sq Ft: 2.94

#2255
PC:M103
Sq Ft: 3.52

Accepts 2 1/4" Inserts
Section O6

Accent Moldings

The #1741 and #1928 moldings can be used by themselves or applied as an accent to crown molding.

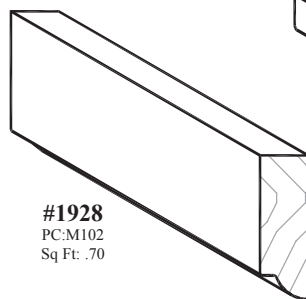

#1928
PC:M102
Sq Ft: .70

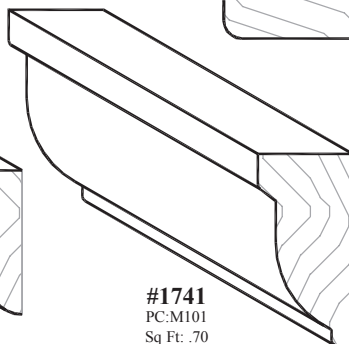

#1741
PC:M101
Sq Ft: .70

FRC = Fastener Relief Cut.

C = Available for Convex/Concave products.

★ = Available with 3D Laminate/RTF.

▶ For PRICING ▶ See Section N1 in our Wholesale Pricing Catalog.

Moldings

Crown Molding

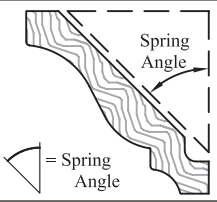

#844
PC: M101
Sq Ft: 1.70

#848
PC: M101 + Assembly Fee
Sq Ft: 2.72
Two pieces, assembled by WalzCraft.

#1888
PC: M101
Sq Ft: 2.72

#1889
PC: M101 + Assembly Fee
Sq Ft: 3.75
Two pieces, assembled by WalzCraft.

#2580
PC: M101
Sq Ft: 2.49

#146
PC: M101
Sq Ft: 1.84

#120
PC: M101 + Assembly Fee
Sq Ft: 2.85
Two pieces, assembled by WalzCraft.

#155
PC: M101
Sq Ft: 2.38

#850
PC: M101 + Assembly Fee
Sq Ft: 3.40
Two pieces, assembled by WalzCraft.

(844) (864) (1888) (864) (146) (864) (155) (864)

FRC = Fastener Relief Cut. **C** = Available for Convex/Concave products. ★ = Available with 3D Laminate/RTF.

► For PRICING ► See Section N1 in our Wholesale Pricing Catalog.

Crown Molding

Moldings

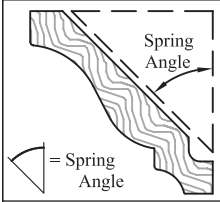

★
C
#383
PC: M101
Sq Ft: 1.96

#389
PC: M101 + Assembly Fee
Sq Ft: 2.97
Two pieces, assembled by WalzCraft.

C

FRC



(383)

#389

(864)

★

#1160
PC: M101
Sq Ft: 2.83

#1192
PC: M101 + Assembly Fee
Sq Ft: 3.85
Two pieces, assembled by WalzCraft.

#2254
PC: M101
Sq Ft: 2.32

FRC



(1160)

#1192

(864)

38°

★

C

#942
PC: M101
Sq Ft: 1.89

#943
PC: M101 + Assembly Fee
Sq Ft: 2.90
Two pieces, assembled by WalzCraft.

#2248
PC: M101
Sq Ft: 2.97

FRC



(942)

#943

(864)

#2267
PC: M101 + Assembly Fee
Sq Ft: 3.98
Two pieces, assembled by WalzCraft.

FRC



(2248)

#2267

(864)

★

#119
PC: M101
Sq Ft: 1.34



FRC = Fastener Relief Cut.

C = Available for Convex/Concave products.

★ = Available with 3D Laminate/RTF.

▶ For PRICING ▶ See Section N1 in our Wholesale Pricing Catalog.

Moldings

Crown Molding

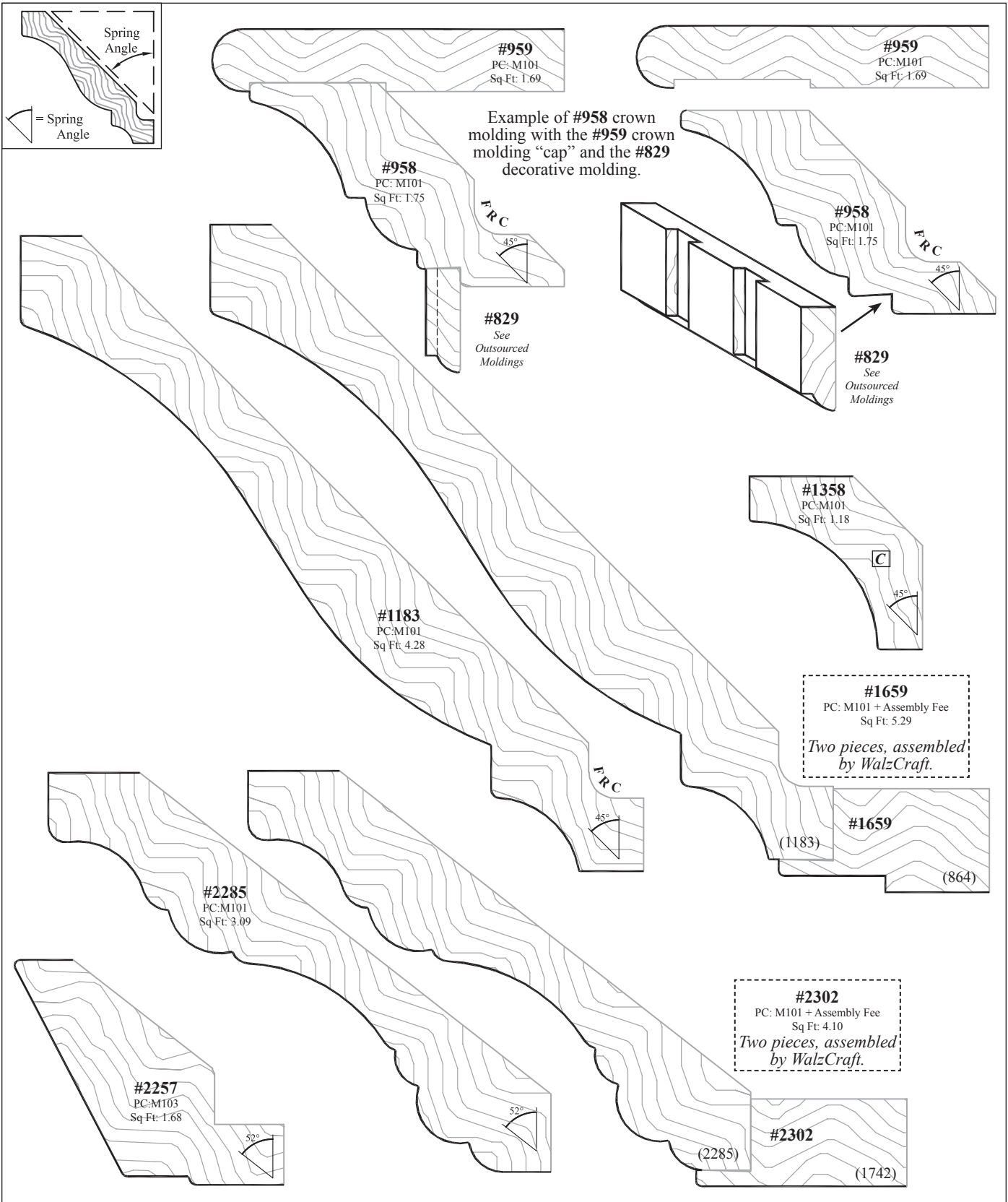

FRC = Fastener Relief Cut.

C = Available for Convex/Concave products.

★ = Available with 3D Laminate/RTF.

► For PRICING ► See Section N1 in our Wholesale Pricing Catalog.



Crown Molding

Moldings

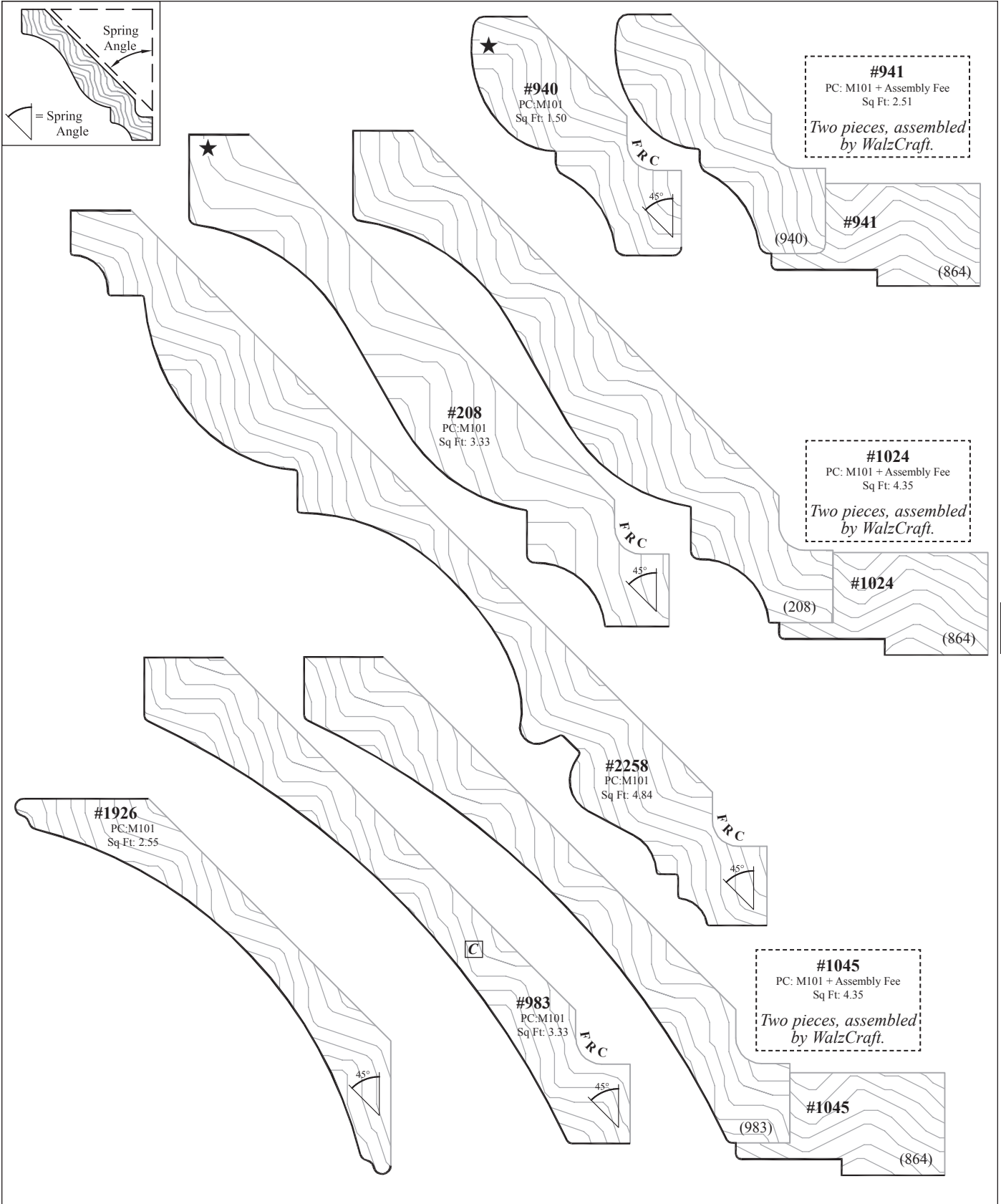

FRC = Fastener Relief Cut. ◻ = Available for Convex/Concave products. ★ = Available with 3D Laminate/RTF.

▶ For PRICING ▶ See Section N1 in our Wholesale Pricing Catalog.

Moldings

Crown Molding

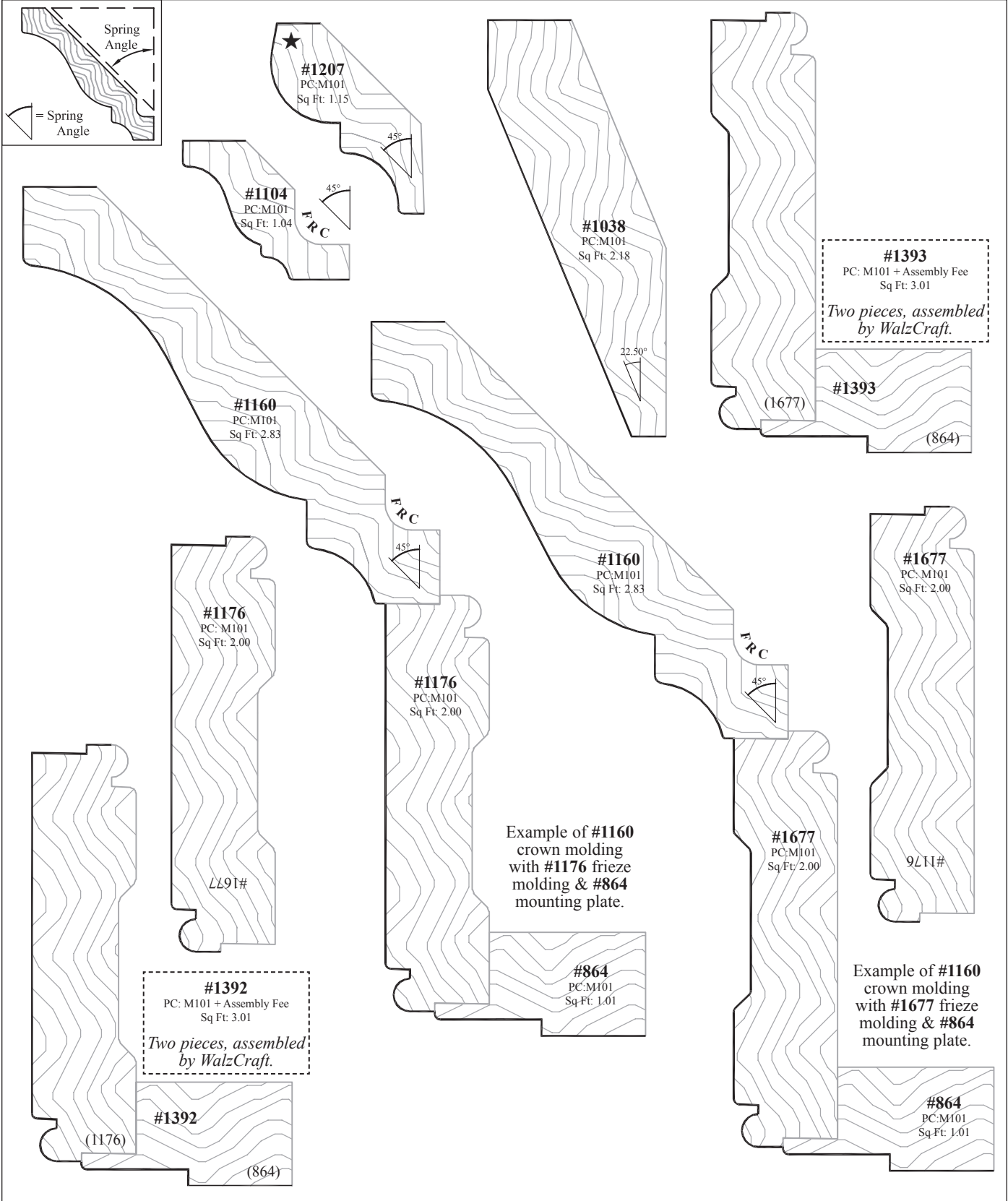

FRC = Fastener Relief Cut.

☐ = Available for Convex/Concave products.

★ = Available with 3D Laminate/RTF.

► For PRICING ► See Section N1 in our Wholesale Pricing Catalog.



Crown Molding

Moldings

Spring Angle
= Spring Angle

Mounting Plate
#1742
PC:M101
Sq Ft: 1.01

#2256
PC:M101
Sq Ft: 2.40

#2259
PC:M101
Sq Ft: 3.21

#2468
PC:M101
Sq Ft: 3.67

#1346
PC:M101
Sq Ft: 2.83

#1293
PC:M103
Sq Ft: 6.01

#2252
PC:M101
Sq Ft: 5.49

#1742
PC:M101
Sq Ft: 1.01

FRC

FRC

FRC

52°

45°

45°

45°

38°

38°

Example of #2252 crown molding with #1742 mounting plate.

FRC = Fastener Relief Cut. C = Available for Convex/Concave products. ★ = Available with 3D Laminate/RTF.

▶ For PRICING ▶ See Section N1 in our Wholesale Pricing Catalog.

Moldings

Crown Molding

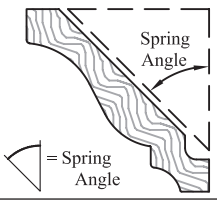

#1675
PC: M101
Sq Ft: 1.84

#1678
PC: M101 + Assembly Fee
Sq Ft: 2.85
Two pieces, assembled by WalzCraft.

#1673
PC: M101
Sq Ft: 2.82

#1697
PC: M101 + Assembly Fee
Sq Ft: 3.83
Two pieces, assembled by WalzCraft.

#1915
PC: M101
Sq Ft: 2.15

#1696
PC: M101 + Assembly Fee
Sq Ft: 2.85
Two pieces, assembled by WalzCraft.

#1672
PC: M101
Sq Ft: 1.84

#1679
PC: M101 + Assembly Fee
Sq Ft: 3.83
Two pieces, assembled by WalzCraft.

#1674
PC: M101
Sq Ft: 2.82

FRC

45°

(1675)

(864)

(1673)

(864)

(1672)

(864)

(1674)

(864)

N

FRC = Fastener Relief Cut. C = Available for Convex/Concave products. ★ = Available with 3D Laminate/RTF.

► For PRICING ► See Section N1 in our Wholesale Pricing Catalog.

Crown Molding

Moldings

#1914
PC:M101
Sq Ft: 3.30

#1805
PC:M101
Sq Ft: 2.36

#2464
PC:M101
Sq Ft: 2.57

#1327
PC:M101
Sq Ft: 3.00

#1615
PC:M101
Sq Ft: 3.73

#1702
PC:M101
Sq Ft: 2.99

#1703
PC: M101 + Assembly Fee
Sq Ft: 4.49
Two pieces, assembled by WalzCraft.

#1361
PC: M101
Sq Ft: 1.45

#1008
Rope Molding
See Outsourced Moldings

#1893
PC:M101
Sq Ft: .70
Mounting Plate

#1701
PC:M101
Sq Ft: 1.50

Spring Angle

= Spring Angle

FRC

Example of #1361 crown molding with #1893 mounting plate and #1008 rope molding.

Molding #1702 and Straight Crown Assembly #1703 are available with most Outside Edge Profiles. See our *Web Site* under Technical Information for compatibility.

Shown with a D17 edge.

FRC = Fastener Relief Cut. ☐ = Available for Convex/Concave products. ★ = Available with 3D Laminate/RTF.

▶ For PRICING ▶ See Section N1 in our Wholesale Pricing Catalog.

Moldings

Crown Molding

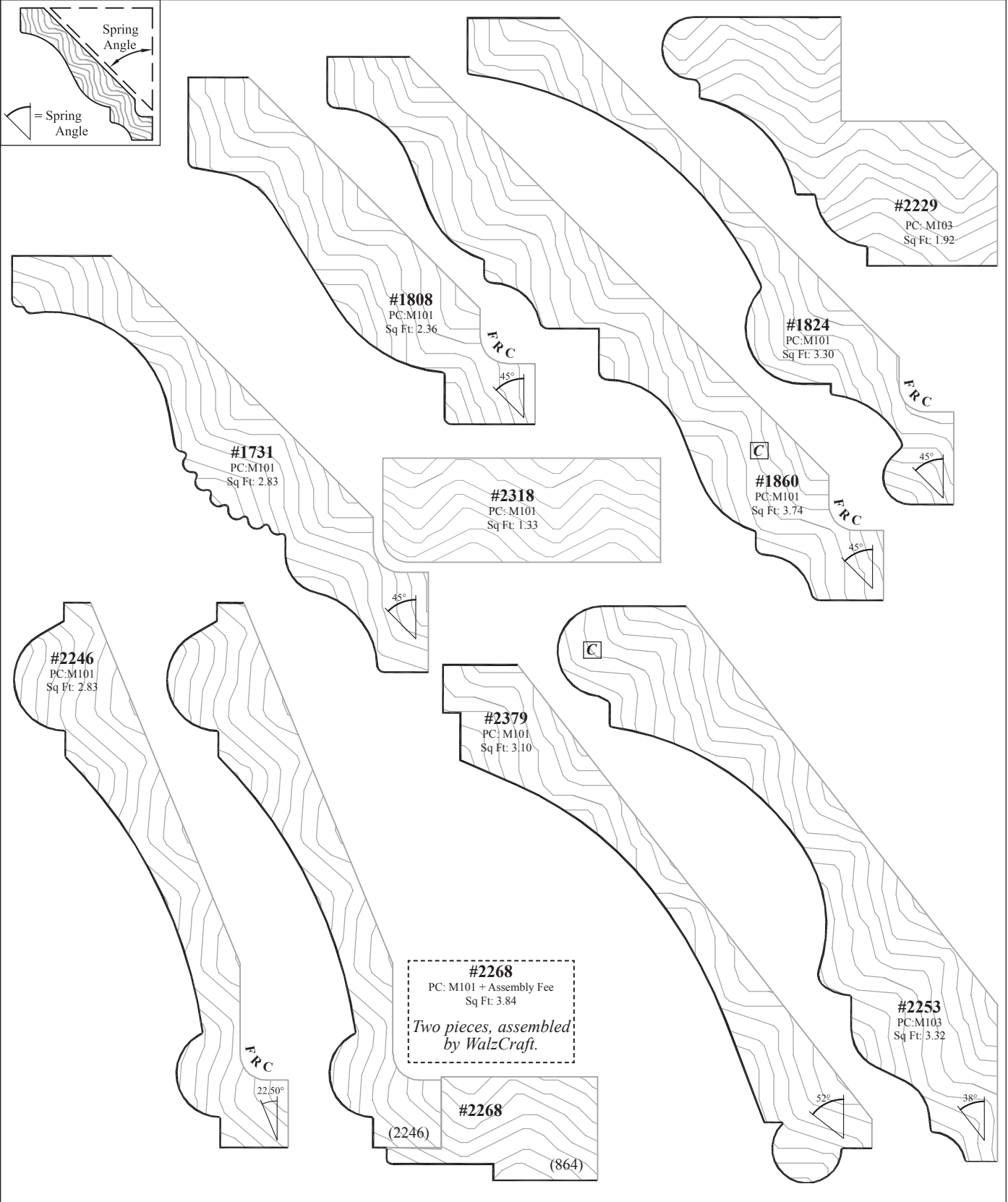

FRC = Fastener Relief Cut. C = Available for Convex/Concave products. ★ = Available with 3D Laminate/RTF.

► For PRICING ► See Section N1 in our Wholesale Pricing Catalog.

Crown Molding

Moldings

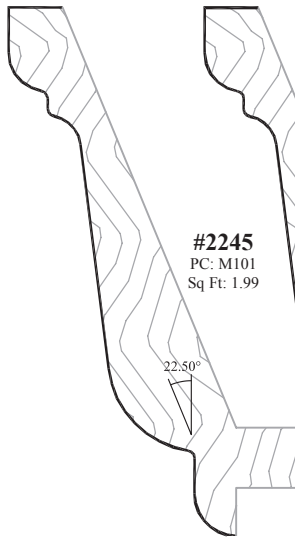
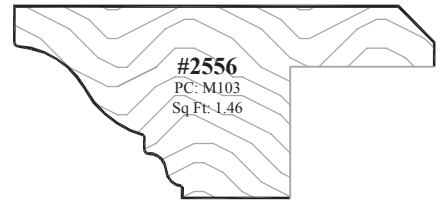
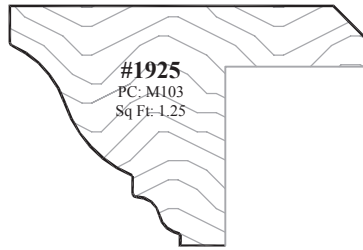
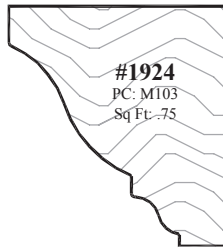
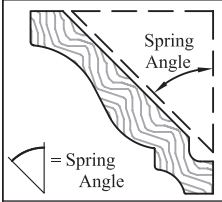

#2269
PC: M101 + Assembly Fee
Sq Ft: 2.99

Two pieces, assembled by WalzCraft.

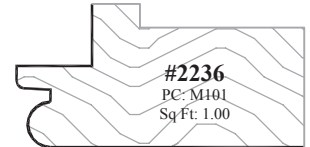

#2237
PC: M101 + Assembly Fee
Sq Ft: 3.38

Two pieces, assembled by WalzCraft.

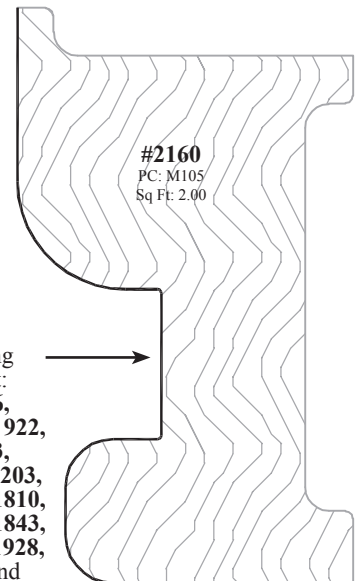
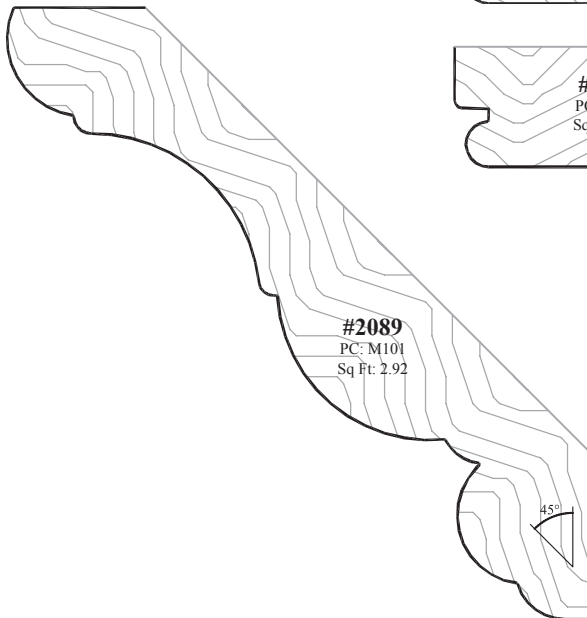
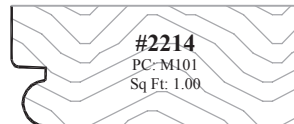
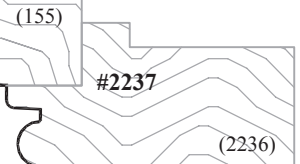

For an additional accent, the following moldings work best:
#239, 810, 812, 816, 818, 829, 832, 914, 922, 931, 955, 956, 1043, 1149, 1163, 1164, 1203, 1266, 1398, 1732, 1810, 1815, 1816, 1821, 1843, 1895, 1902, 1911, 1928, 1971, 1998, 2008 and 2044.

FRC = Fastener Relief Cut.

☐ = Available for Convex/Concave products.

★ = Available with 3D Laminate/RTF.

▶ For PRICING ▶ See Section N1 in our Wholesale Pricing Catalog.

Moldings

Crown Molding

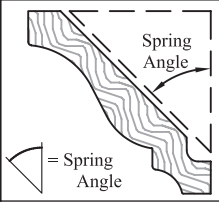

#2623
PC: M101
Sq Ft: 2.68

#2608
PC: M101
Sq Ft: 2.83

#2585
PC: M101
Sq Ft: 1.33

#2586
PC: M101
Sq Ft: 1.33

#2624
PC: M101 + Assembly Fee
Sq Ft: 3.69

*Two pieces, assembled
by WalzCraft.*

#2624

(2623)

(864)

FRC = Fastener Relief Cut.

C = Available for Convex/Concave products.

★ = Available with 3D Laminate/RTF.

► For PRICING ► See Section N1 in our Wholesale Pricing Catalog.



Moldings

Refacing Molding

1/8" Refacing Molding

Drawing not to Scale

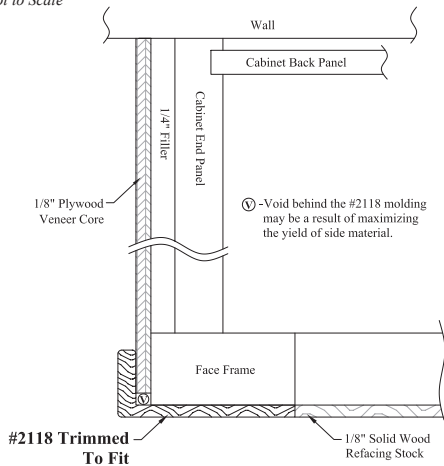

Molding #	Dimension "A"	Dimension "B"	Price Class	Square Foot
2115	1 ³ / ₁₆ " [30mm]	1" [25mm]	M101	.79
2331	1 ⁵ / ₁₆ " [33mm]	1 ¹ / ₈ " [29mm]	M101	.88
2116	1 ⁷ / ₁₆ " [37mm]	1 ¹ / ₄ " [32mm]	M101	.96
2332	1 ⁹ / ₁₆ " [40mm]	1 ³ / ₈ " [35mm]	M101	1.04
2117	1 ¹¹ / ₁₆ " [43mm]	1 ¹ / ₂ " [38mm]	M101	1.13
2333	1 ¹³ / ₁₆ " [46mm]	1 ⁵ / ₈ " [41mm]	M101	1.21
2118	1 ¹⁵ / ₁₆ " [49mm]	1 ³ / ₄ " [44mm]	M101	1.29
2334	2 ¹ / ₁₆ " [52mm]	1 ⁷ / ₈ " [48mm]	M101	1.38
2119	2 ³ / ₁₆ " [56mm]	2" [51mm]	M101	1.46
2335	2 ⁵ / ₁₆ " [59mm]	2 ¹ / ₈ " [54mm]	M101	1.54
2166	2 ⁷ / ₁₆ " [62mm]	2 ¹ / ₄ " [57mm]	M101	1.63
2336	2 ⁹ / ₁₆ " [65mm]	2 ³ / ₈ " [60mm]	M101	1.71
2120	2 ¹¹ / ₁₆ " [68mm]	2 ¹ / ₂ " [64mm]	M101	1.79
2337	2 ¹³ / ₁₆ " [71mm]	2 ⁵ / ₈ " [67mm]	M101	1.88
2167	2 ¹⁵ / ₁₆ " [75mm]	2 ³ / ₄ " [70mm]	M101	1.96
2338	3 ¹ / ₁₆ " [78mm]	2 ⁷ / ₈ " [73mm]	M101	2.04
2168	3 ³ / ₁₆ " [81mm]	3" [76mm]	M101	2.13
2339	3 ⁵ / ₁₆ " [84mm]	3 ³ / ₈ " [79mm]	M101	2.21
2169	3 ⁷ / ₁₆ " [87mm]	3 ¹ / ₄ " [83mm]	M101	2.29
2340	3 ⁹ / ₁₆ " [90mm]	3 ³ / ₈ " [86mm]	M101	2.38
2341	3 ¹¹ / ₁₆ " [94mm]	3 ¹ / ₂ " [89mm]	M101	2.46

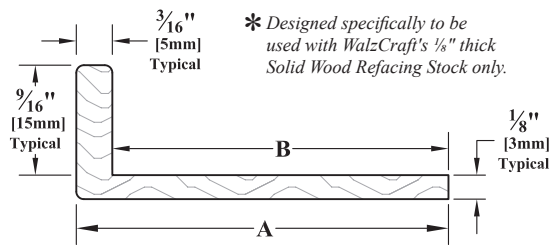

3/16" Refacing Molding

Drawing not to Scale

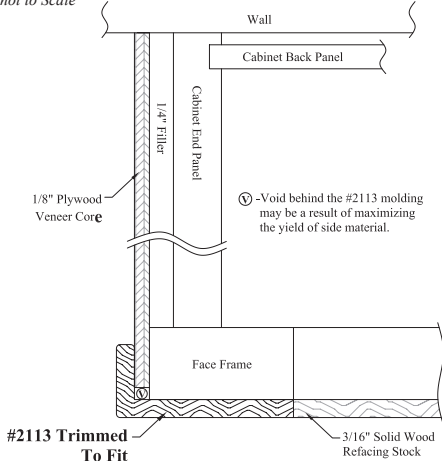

Molding #	Dimension "A"	Dimension "B"	Price Class	Square Foot
2145	1 ³ / ₁₆ " [30mm]	1" [25mm]	M101	.79
2342	1 ⁵ / ₁₆ " [33mm]	1 ¹ / ₈ " [29mm]	M101	.88
2111	1 ⁷ / ₁₆ " [37mm]	1 ¹ / ₄ " [32mm]	M101	.96
2343	1 ⁹ / ₁₆ " [40mm]	1 ³ / ₈ " [35mm]	M101	1.04
2142	1 ¹¹ / ₁₆ " [43mm]	1 ¹ / ₂ " [38mm]	M101	1.13
2344	1 ¹³ / ₁₆ " [46mm]	1 ⁵ / ₈ " [41mm]	M101	1.21
2113	1 ¹⁵ / ₁₆ " [49mm]	1 ³ / ₄ " [44mm]	M101	1.29
2345	2 ¹ / ₁₆ " [52mm]	1 ⁷ / ₈ " [48mm]	M101	1.38
2114	2 ³ / ₁₆ " [56mm]	2" [51mm]	M101	1.46
2346	2 ⁵ / ₁₆ " [59mm]	2 ¹ / ₈ " [54mm]	M101	1.54
2162	2 ⁷ / ₁₆ " [62mm]	2 ¹ / ₄ " [57mm]	M101	1.63
2347	2 ⁹ / ₁₆ " [65mm]	2 ³ / ₈ " [60mm]	M101	1.71
2143	2 ¹¹ / ₁₆ " [68mm]	2 ¹ / ₂ " [64mm]	M101	1.79
2348	2 ¹³ / ₁₆ " [71mm]	2 ⁵ / ₈ " [67mm]	M101	1.88
2163	2 ¹⁵ / ₁₆ " [75mm]	2 ³ / ₄ " [70mm]	M101	1.96
2349	3 ¹ / ₁₆ " [78mm]	2 ⁷ / ₈ " [73mm]	M101	2.04
2164	3 ³ / ₁₆ " [81mm]	3" [76mm]	M101	2.13
2350	3 ⁵ / ₁₆ " [84mm]	3 ³ / ₈ " [79mm]	M101	2.21
2165	3 ⁷ / ₁₆ " [87mm]	3 ¹ / ₄ " [83mm]	M101	2.29
2351	3 ⁹ / ₁₆ " [90mm]	3 ³ / ₈ " [86mm]	M101	2.38
2352	3 ¹¹ / ₁₆ " [94mm]	3 ¹ / ₂ " [89mm]	M101	2.46

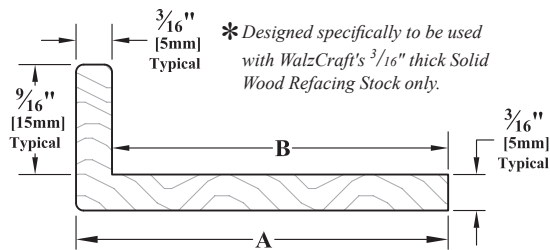

* We can control the finished thickness of the Refacing Moldings and Solid Wood Refacing Stock as they are produced in house. These moldings are not intended to be used with sheet stock (on face of cabinet), as plywood thicknesses are beyond our ability to control.

Miscellaneous Refacing Molding

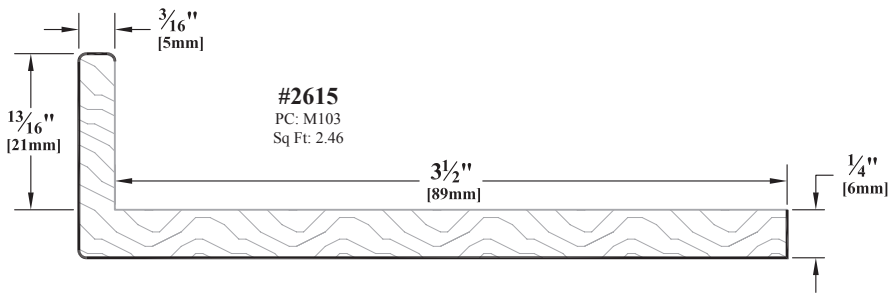
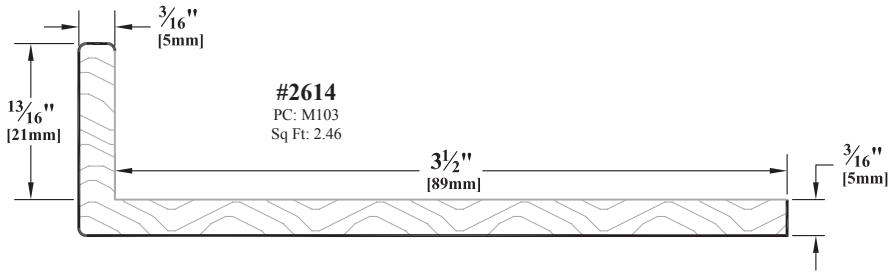
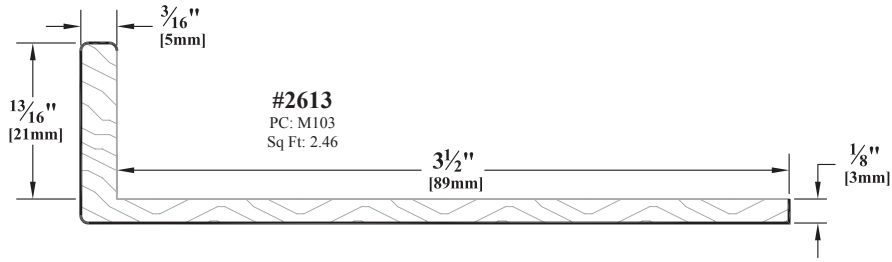

N

For 1/4" Plywood

#2353 PC: M102 Sq Ft: .70	#2354 PC: M102 Sq Ft: .70	#2355 PC: M102 Sq Ft: .79	#2356 PC: M102 Sq Ft: .96
--	--	--	--

For 1/8" Plywood

#2101 PC: M102 Sq Ft: .70	#2357 PC: M102 Sq Ft: .70	#2358 PC: M102 Sq Ft: .79	#2359 PC: M102 Sq Ft: .96
--	--	--	--

For Wood Back Veneer

#2124
PC: M102
Sq Ft: .70

For 1/8" Plywood

#870
PC: M102
Sq Ft: .70

For 1/4" Plywood

#2023
PC: M101
Sq Ft: .70

► For PRICING ► See Section N2 in our Wholesale Pricing Catalog.

Solid Wood Refacing Stock

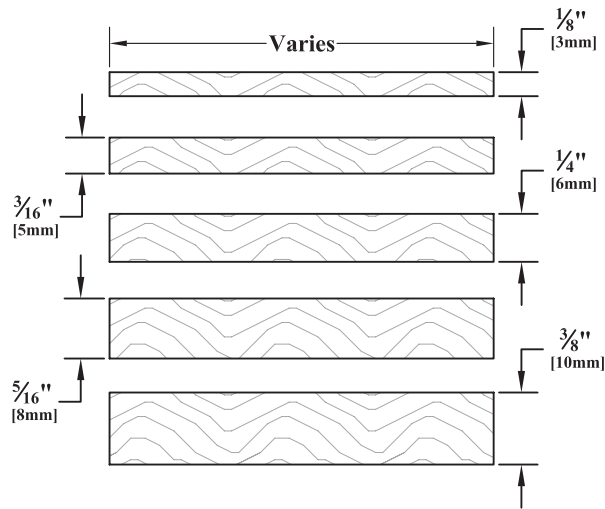

N

Solid Wood Refacing Stock Notes

1)	Pricing	Please see <i>Section N2</i> of the Wholesale Pricing Catalog .
2)	RFS100	Refacing Stock uses part # RFS100 .
3)	Thickness	Available in 1/8", 3/16", 1/4", 5/16" and 3/8" thicknesses.
4)	Width	Minimum width dimension is 5/8" and can be ordered in 1/16" increments or dimensions rounded to the nearest whole millimeter.
		Maximum width is 6". WalzCraft makes every attempt to produce these parts from one solid piece of wood. A GUPFS may be required for sizes <u>wider</u> than 6", see <i>Section M16</i> . At times, due to lumber availability, a GUPFS may also be required for widths <u>under</u> 6".
5)	Length	The maximum length for 8' or Cut-to-Length refacing stock is 96".
		Random Length pieces will vary between 36" and 96".
6)	Minimum Order Quantity	No minimum order quantity.
7)	Finishing	Finished on one (1) face and all edges. The back is left unfinished for proper glue adhesion. Please see our Finishing section for information on Glazing.
8)	Knotty & Rustic Grades	Knotty and Rustic grade materials will only have small knots, if any.
9)	3D Laminate (RTF)	3D Laminate (RTF) Refacing Stock is made of a solid wood core (Maple - Paint Grade) and is not subject to the same thickness limitations as MDF. Maximum length of 96".

► For **PRICING** ► See *Section N2* in our Wholesale Pricing Catalog.

Corner & Scribe Molding

Moldings

Outside Corner Molding

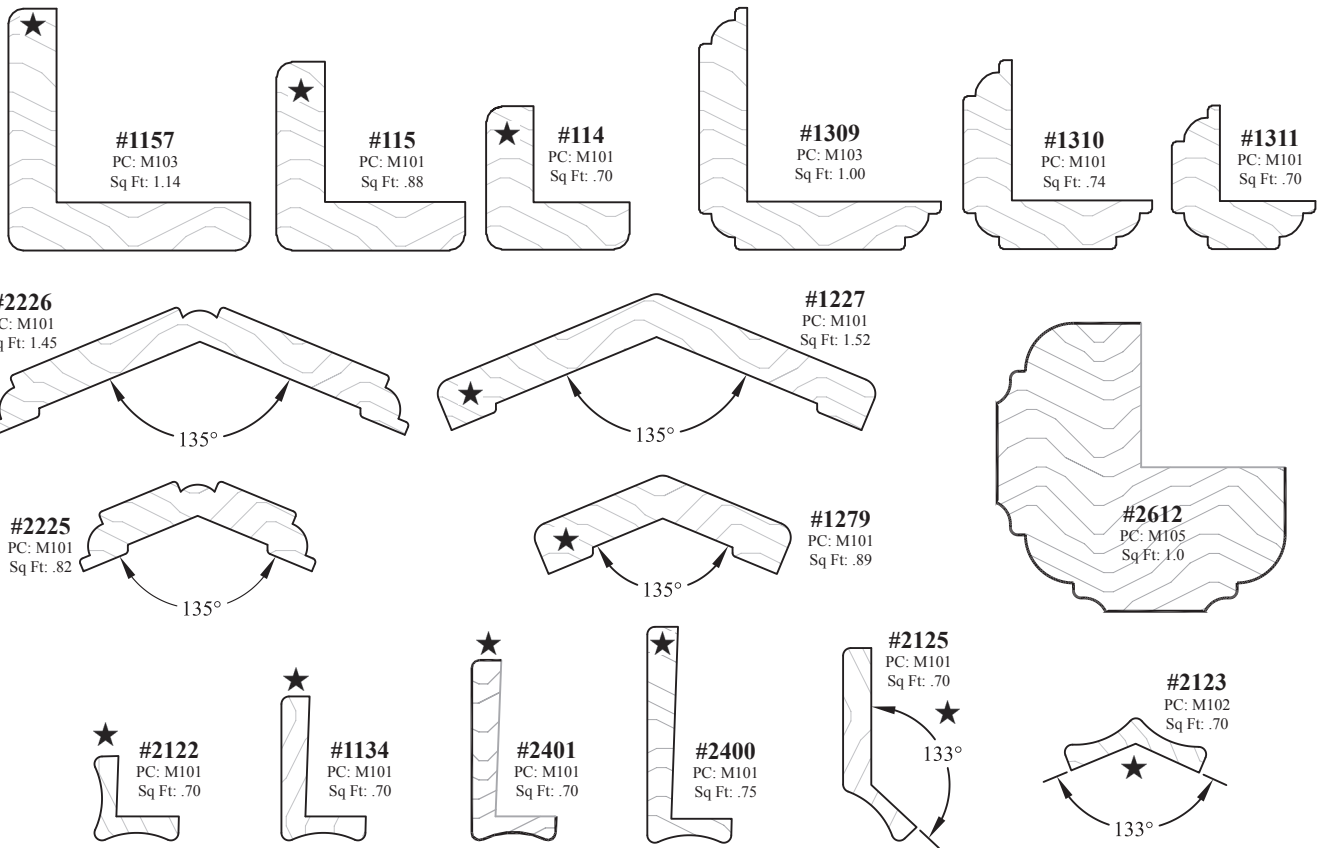

Cove Molding

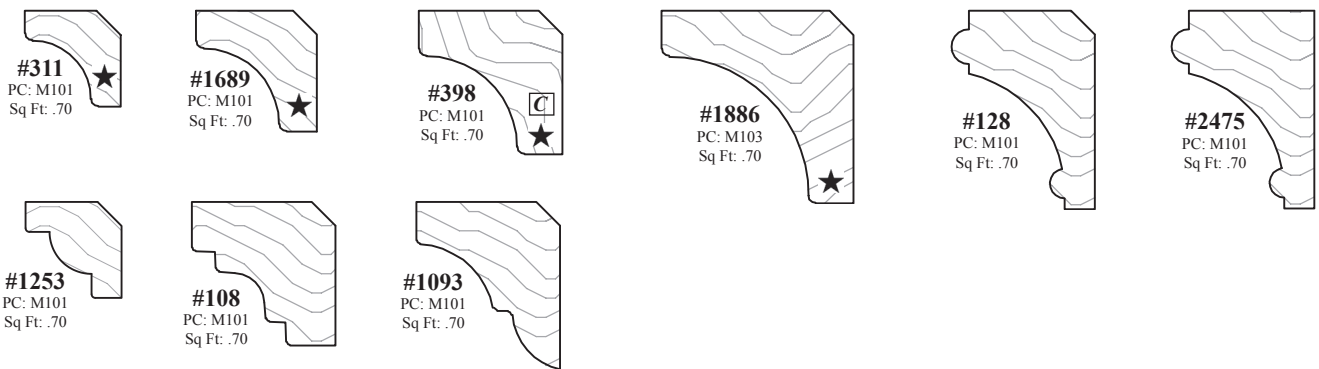

Base Shoe and Quarter Round Molding

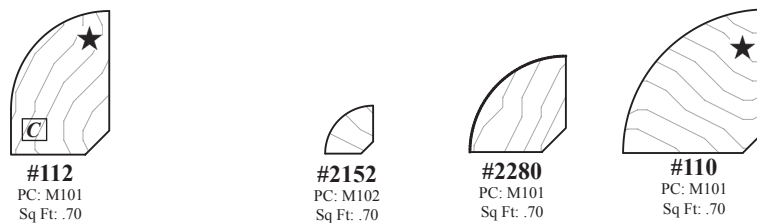

▶ For PRICING ▶ See Section N3 in our Wholesale Pricing Catalog.

Moldings

Corner & Scribe Molding

Scribe Molding



#147
PC: M102
Sq Ft: .70

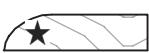

#310
PC: M102
Sq Ft: .70



#309
PC: M102
Sq Ft: .70

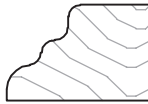

#887
PC: M101
Sq Ft: .70

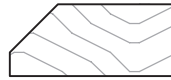

#1771
PC: M101
Sq Ft: .70



#1391
PC: M102
Sq Ft: .70



#1022
PC: M102
Sq Ft: .70



#1844
PC: M102
Sq Ft: .70

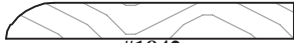

#1842
PC: M102
Sq Ft: 1.00



#1044
PC: M101
Sq Ft: 1.50



#2004
PC: M102
Sq Ft: 1.00



#2003
PC: M102
Sq Ft: .70



#1870
PC: M102
Sq Ft: .70



#2402
PC: M101
Sq Ft: .70



#2549
PC: M102
Sq Ft: 1.67

45° & 90° Transition Molding

45° Cabinet Filler

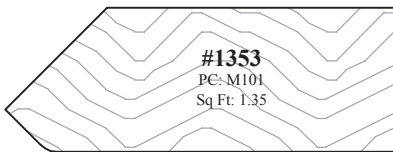

#1353
PC: M101
Sq Ft: 1.35

45° Diagonal Filler

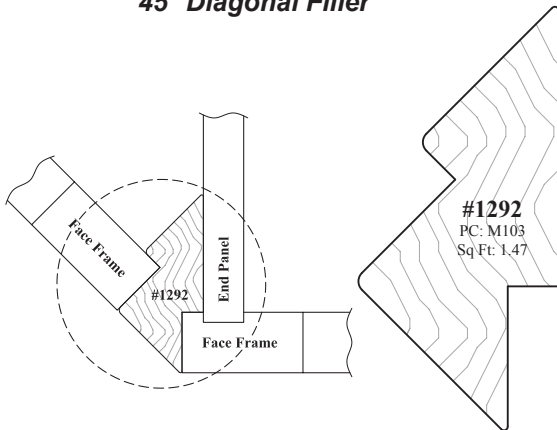

#1292
PC: M103
Sq Ft: 1.47

90° Corner Moldings



#1788
PC: M103
Sq Ft: 1.16

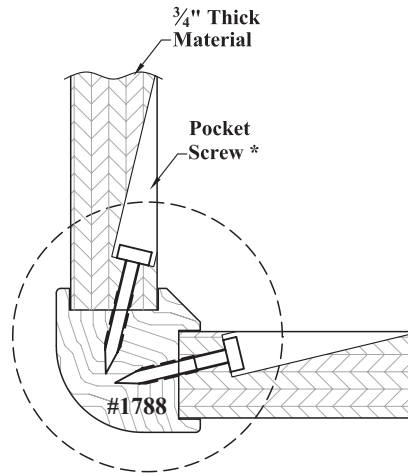

3/4" Thick Material

Pocket Screw *

#1788

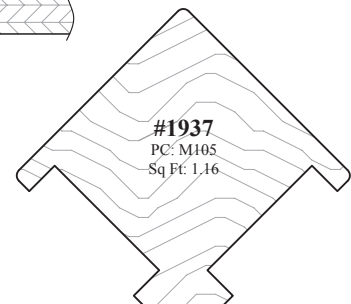

#1937
PC: M105
Sq Ft: 1.16

90° Corner Moldings



#1935
PC: M101
Sq Ft: .70



#1936
PC: M101
Sq Ft: .70

*Pocket screwing is just one possible method of attaching your 3/4" thick material to the corner molding.

► For PRICING ► See Section N3 in our Wholesale Pricing Catalog.

90° Corner Door Molding

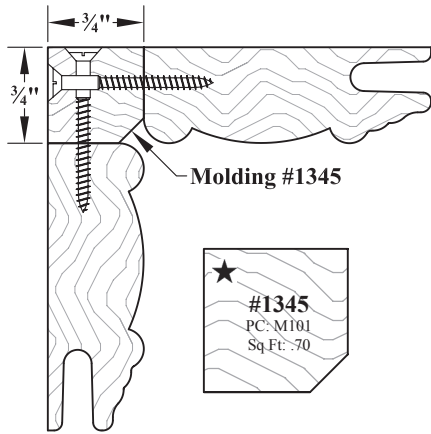

"Inside" Corner Molding

90° Inside Corner

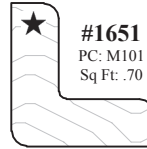

135° Inside Corner

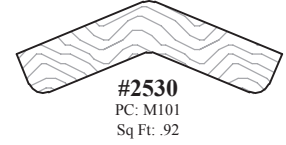

▶ For PRICING ▶ See Section N3 in our Wholesale Pricing Catalog.

Moldings

Base & Casing Molding

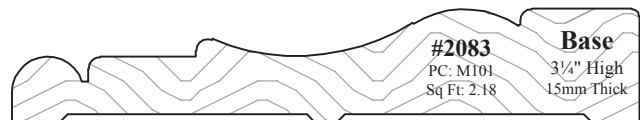
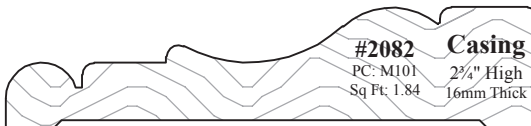
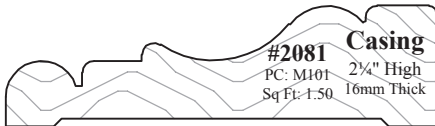
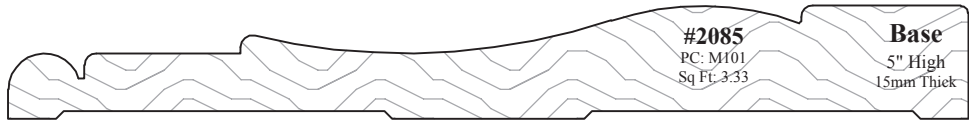
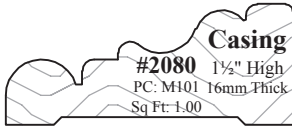
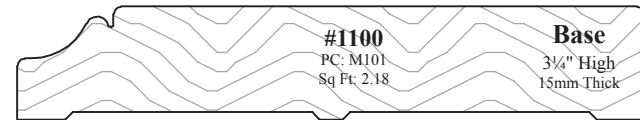
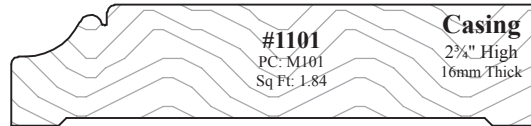
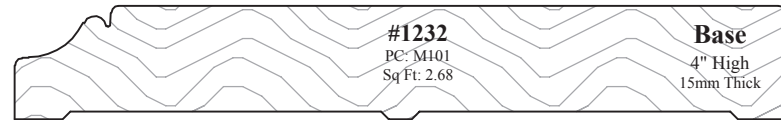
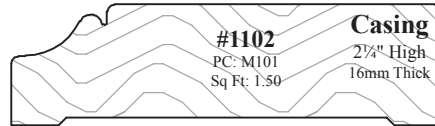
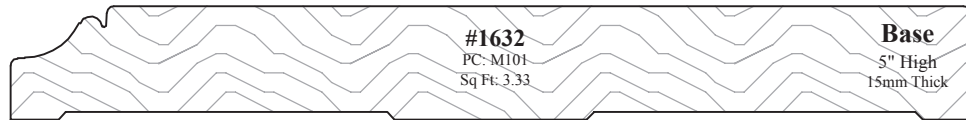
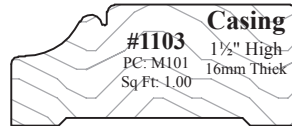
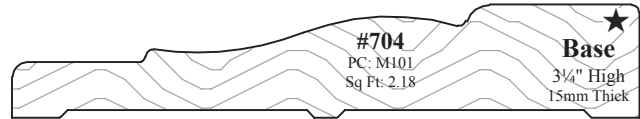
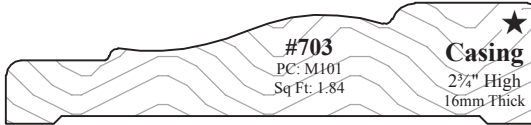
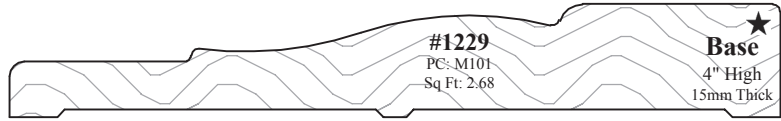
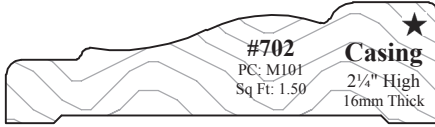
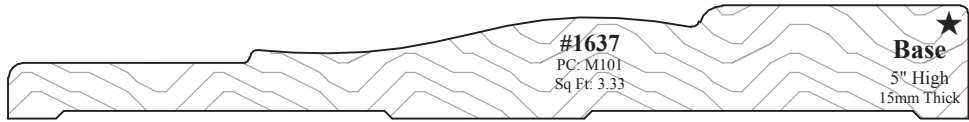
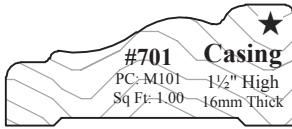

► For PRICING ► See Section N4 in our Wholesale Pricing Catalog.

Base & Casing Molding

Moldings

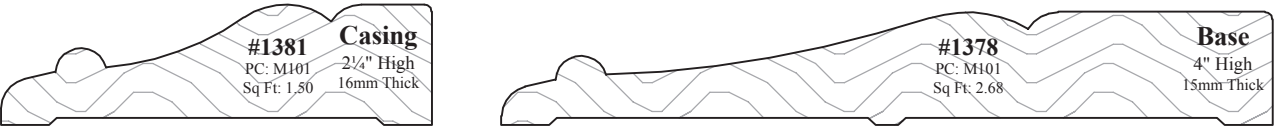
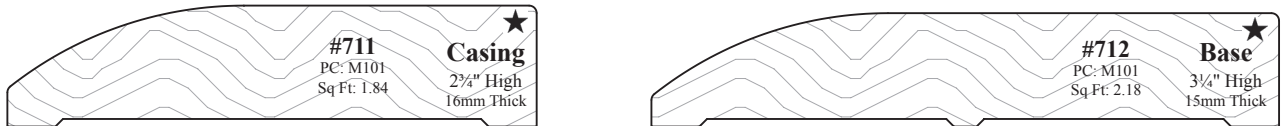
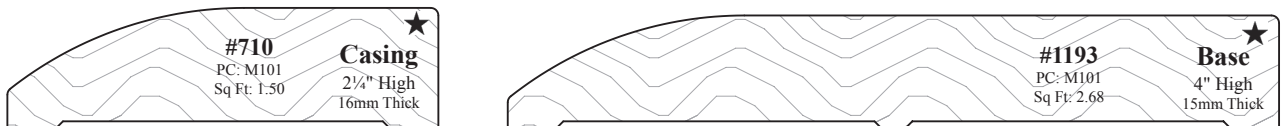
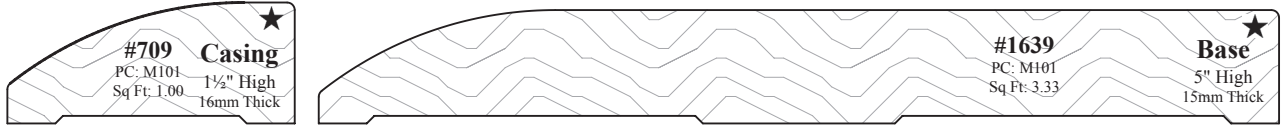
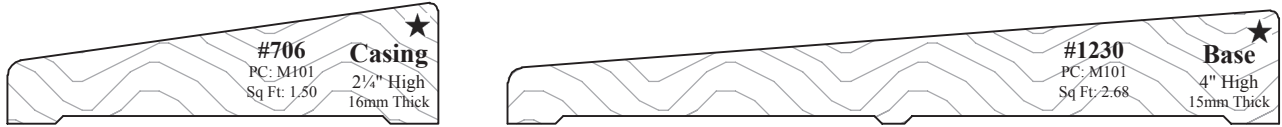
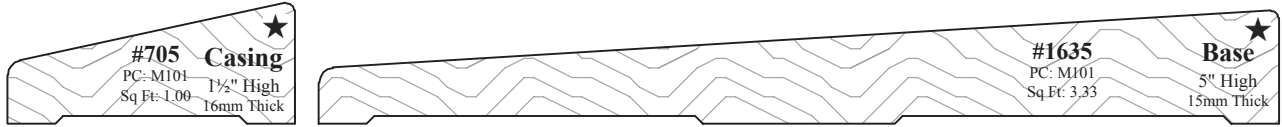



► For PRICING ► See Section N4 in our Wholesale Pricing Catalog.

Moldings

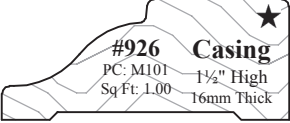
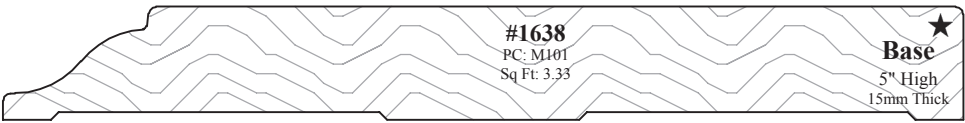
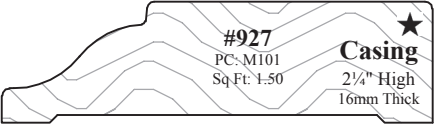
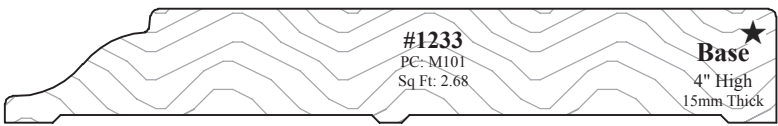
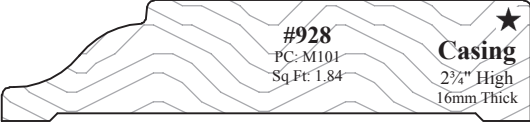
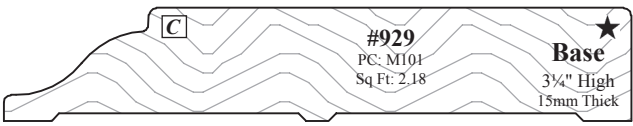
Base & Casing Molding

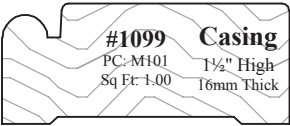
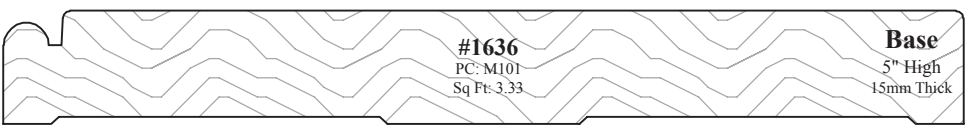
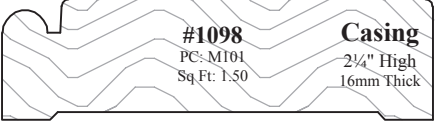
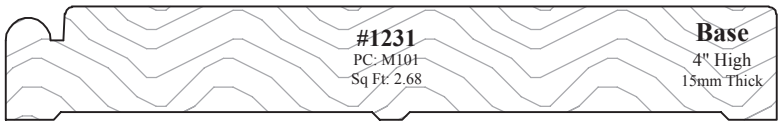
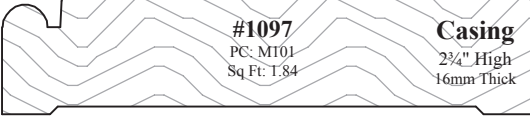
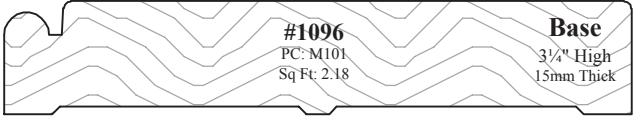
 <p>#926 Casing ★ PC: M101 Sq Ft: 1.00 1½" High 16mm Thick</p>	 <p>#1638 Base ★ PC: M101 Sq Ft: 3.33 5" High 15mm Thick</p>
 <p>#927 Casing ★ PC: M101 Sq Ft: 1.50 2¼" High 16mm Thick</p>	 <p>#1233 Base ★ PC: M101 Sq Ft: 2.68 4" High 15mm Thick</p>
 <p>#928 Casing ★ PC: M101 Sq Ft: 1.84 2¾" High 16mm Thick</p>	 <p>#929 Base ★ PC: M101 Sq Ft: 2.18 3¼" High 15mm Thick</p>

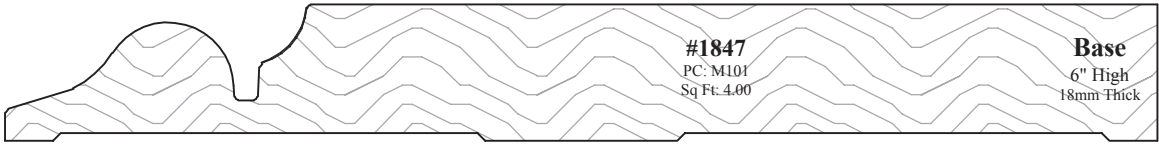
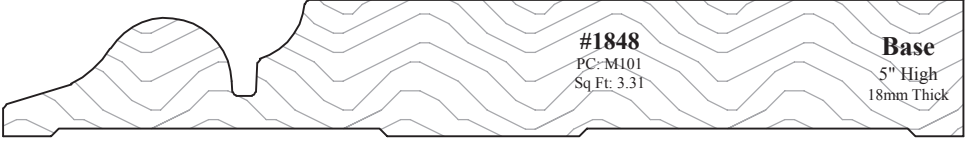
 <p>#1099 Casing PC: M101 Sq Ft: 1.00 1½" High 16mm Thick</p>	 <p>#1636 Base PC: M101 Sq Ft: 3.33 5" High 15mm Thick</p>
 <p>#1098 Casing PC: M101 Sq Ft: 1.50 2¼" High 16mm Thick</p>	 <p>#1231 Base PC: M101 Sq Ft: 2.68 4" High 15mm Thick</p>
 <p>#1097 Casing PC: M101 Sq Ft: 1.84 2¾" High 16mm Thick</p>	 <p>#1096 Base PC: M101 Sq Ft: 2.18 3¼" High 15mm Thick</p>

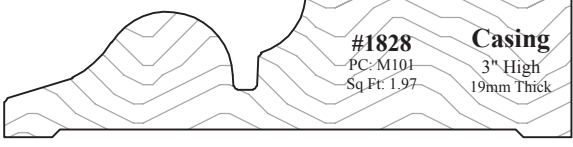
 <p>#1847 Base PC: M101 Sq Ft: 4.00 6" High 18mm Thick</p>
 <p>#1848 Base PC: M101 Sq Ft: 3.31 5" High 18mm Thick</p>
 <p>#1316 Base PC: M101 Sq Ft: 2.83 4¼" High 18mm Thick</p>
 <p>#1828 Casing PC: M101 Sq Ft: 1.97 3" High 19mm Thick</p>

► For PRICING ► See Section N4 in our Wholesale Pricing Catalog.

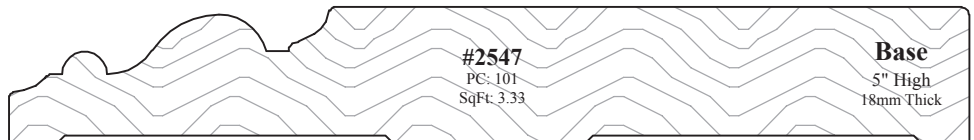
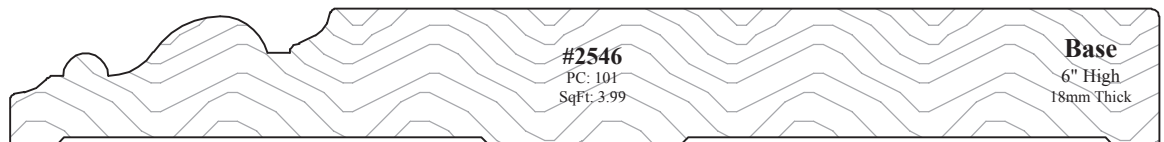
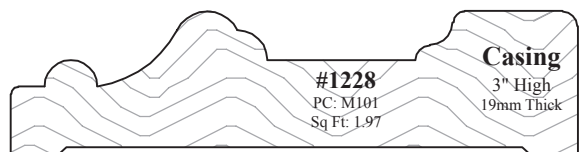
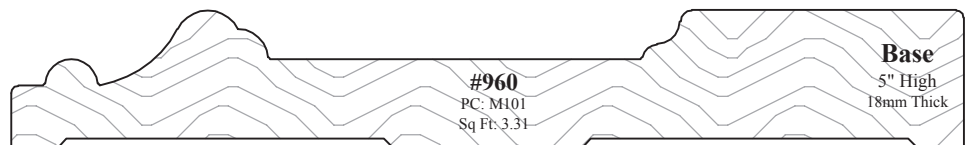
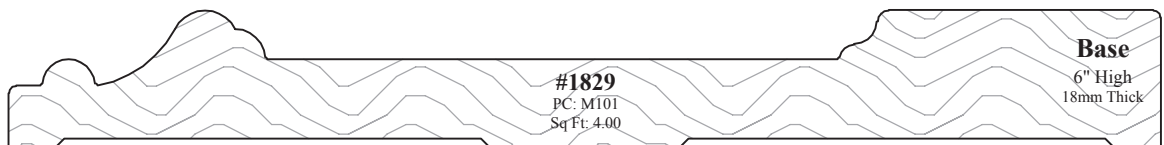
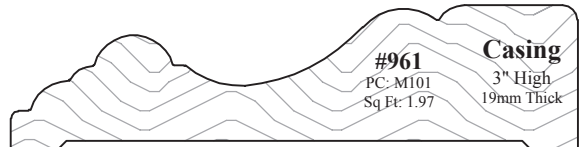

► For PRICING ► See Section N4 in our Wholesale Pricing Catalog.

Applied Moldings - Outside Edge

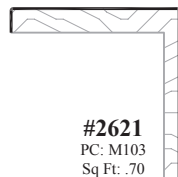
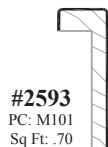
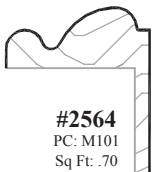
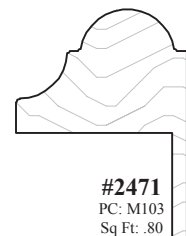
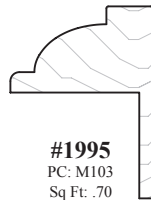
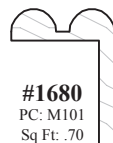
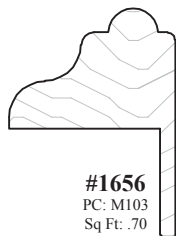
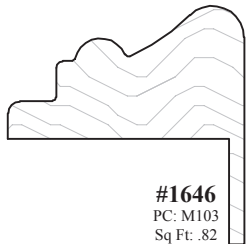
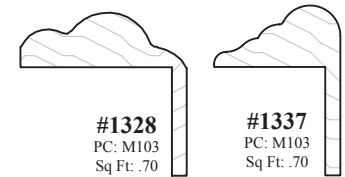
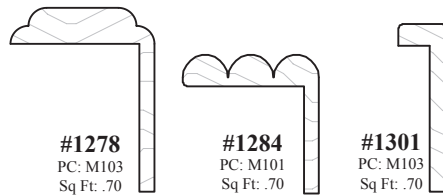
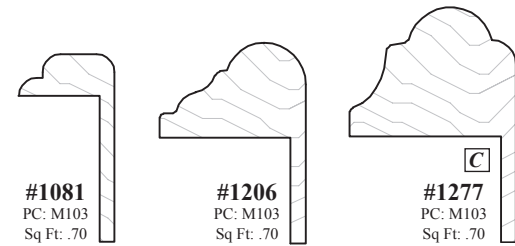
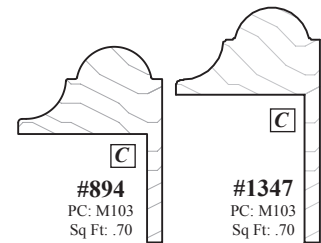
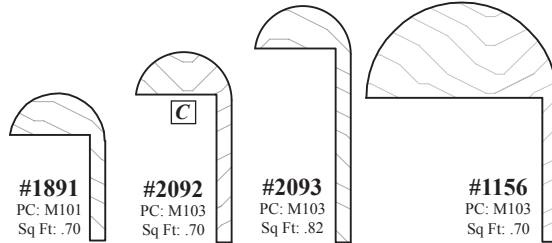
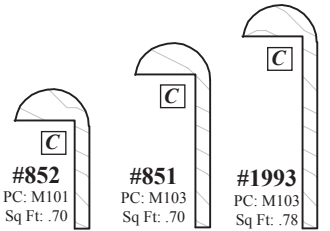
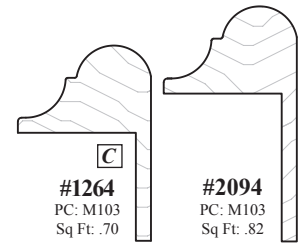
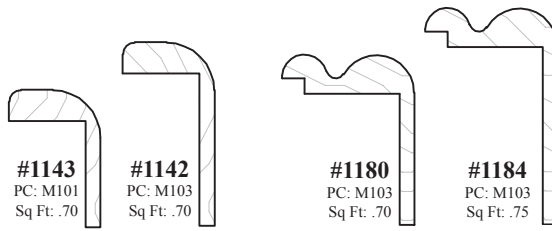
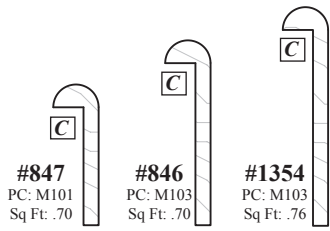

► For PRICING ► See Section N5 in our Wholesale Pricing Catalog.

Applied Moldings - Inside Edge, Shelf, Face

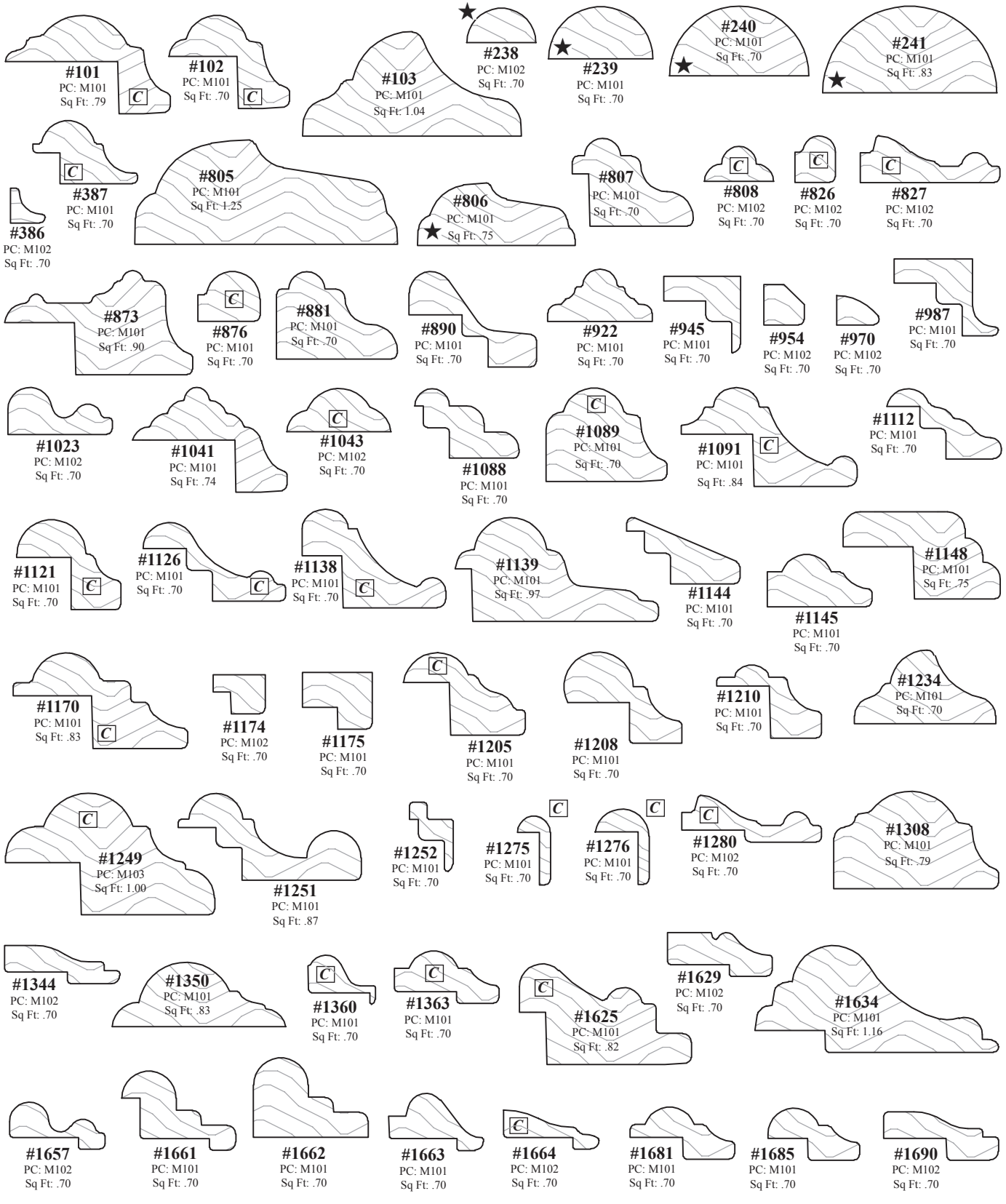

▶ For PRICING ▶ See Section N5 in our Wholesale Pricing Catalog.

Applied Moldings - Inside Edge, Shelf, Face

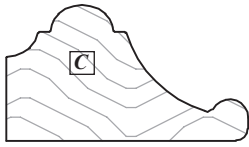

#1691
PC: M101
Sq Ft: .84

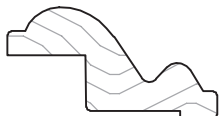

#1692
PC: M101
Sq Ft: .73

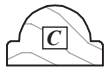

#1693
PC: M102
Sq Ft: .70



#1694
PC: M102
Sq Ft: .70

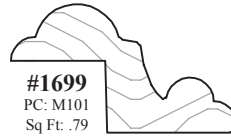

#1699
PC: M101
Sq Ft: .79



#1717
PC: M102
Sq Ft: .70

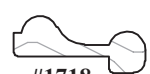

#1718
PC: M102
Sq Ft: .70



#1721
PC: M102
Sq Ft: .70



#1722
PC: M101
Sq Ft: .70



#1734
PC: M101
Sq Ft: .70



#1745
PC: M102
Sq Ft: .70



#1746
PC: M102
Sq Ft: .70



#1751
PC: M101
Sq Ft: .84



#1752
PC: M102
Sq Ft: .70



#1755
PC: M102
Sq Ft: .70



#1770
PC: M102
Sq Ft: .70



#1777
PC: M101
Sq Ft: .70



#1806
PC: M102
Sq Ft: .70



#1809
PC: M101
Sq Ft: .70

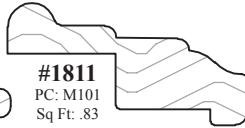

#1811
PC: M101
Sq Ft: .83

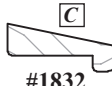

#1832
PC: M102
Sq Ft: .70



#1834
PC: M102
Sq Ft: .70



#1858
PC: M102
Sq Ft: .70



#1861
PC: M102
Sq Ft: .70



#1862
PC: M102
Sq Ft: .70



#1864
PC: M101
Sq Ft: .70



#1874
PC: M101
Sq Ft: .70



#1875
PC: M102
Sq Ft: .84



#1876
PC: M102
Sq Ft: .70

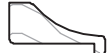

#1880
PC: M102
Sq Ft: .70



#1881
PC: M103
Sq Ft: .76



#1900
PC: M102
Sq Ft: .70



#1901
PC: M102
Sq Ft: .70



#1903
PC: M102
Sq Ft: .70



#1905
PC: M102
Sq Ft: .70



#1907
PC: M101
Sq Ft: .70



#1908
PC: M101
Sq Ft: .70



#1912
PC: M102
Sq Ft: .70



#1913
PC: M102
Sq Ft: .75



#1922
PC: M102
Sq Ft: .75

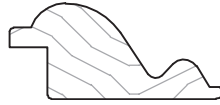

#1927
PC: M101
Sq Ft: .74



#1931
PC: M101
Sq Ft: .70



#1970
PC: M101
Sq Ft: .70



#2007
PC: M101
Sq Ft: .70



#2022
PC: M102
Sq Ft: .70



#2052
PC: M101
Sq Ft: .70



#2053
PC: M101
Sq Ft: .70

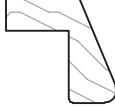

#2054
PC: M101
Sq Ft: .70

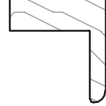

#2056
PC: M101
Sq Ft: .70

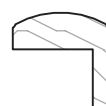

#2057
PC: M101
Sq Ft: .70



#2075
PC: M102
Sq Ft: .70

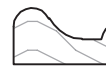

#2079
PC: M102
Sq Ft: .70



#2091
PC: M102
Sq Ft: .70



#2095
PC: M102
Sq Ft: .70

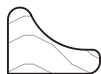

#2172
PC: M102
Sq Ft: .70

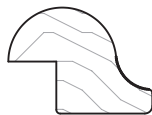

#2213
PC: M101
Sq Ft: .70



#2286
PC: M101
Sq Ft: .70

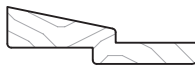

#2297
PC: M102
Sq Ft: .70

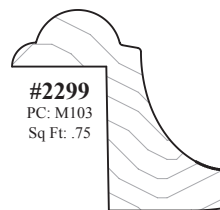

#2299
PC: M103
Sq Ft: .75

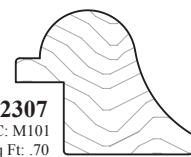

#2307
PC: M101
Sq Ft: .70

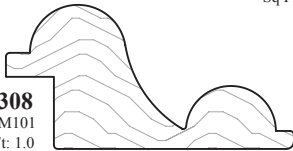

#2308
PC: M101
Sq Ft: 1.0

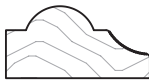

#2315
PC: M101
Sq Ft: .70



#2328
PC: M102
Sq Ft: .70



#2373
PC: M101
Sq Ft: .70



#2385
PC: M102
Sq Ft: .70

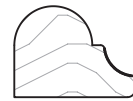

#2397
PC: M101
Sq Ft: .70

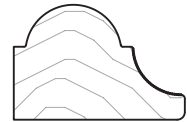

#2398
PC: M101
Sq Ft: .70

► For PRICING ► See Section N5 in our Wholesale Pricing Catalog.

Applied Moldings - Inside Edge, Shelf, Face

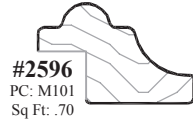
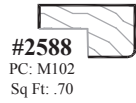
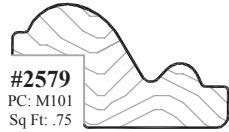
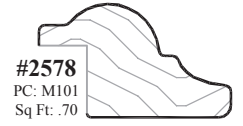
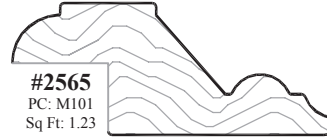
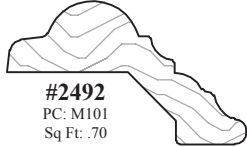
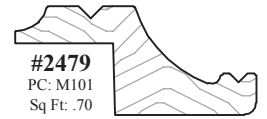
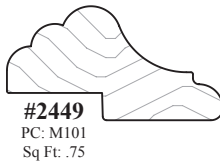
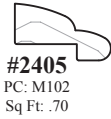
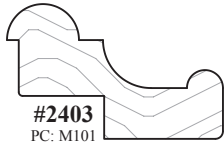

"Old World" Applied Moldings - Inside Edge

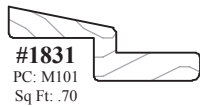
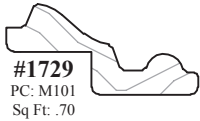
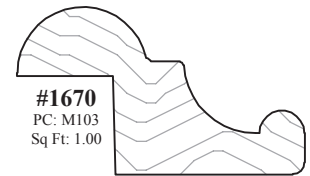
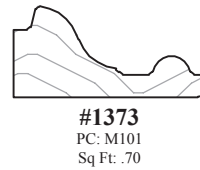
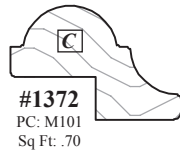
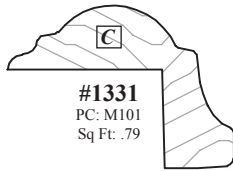
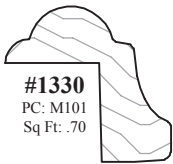

N

► For PRICING ► See Section N5 in our Wholesale Pricing Catalog.

Moldings



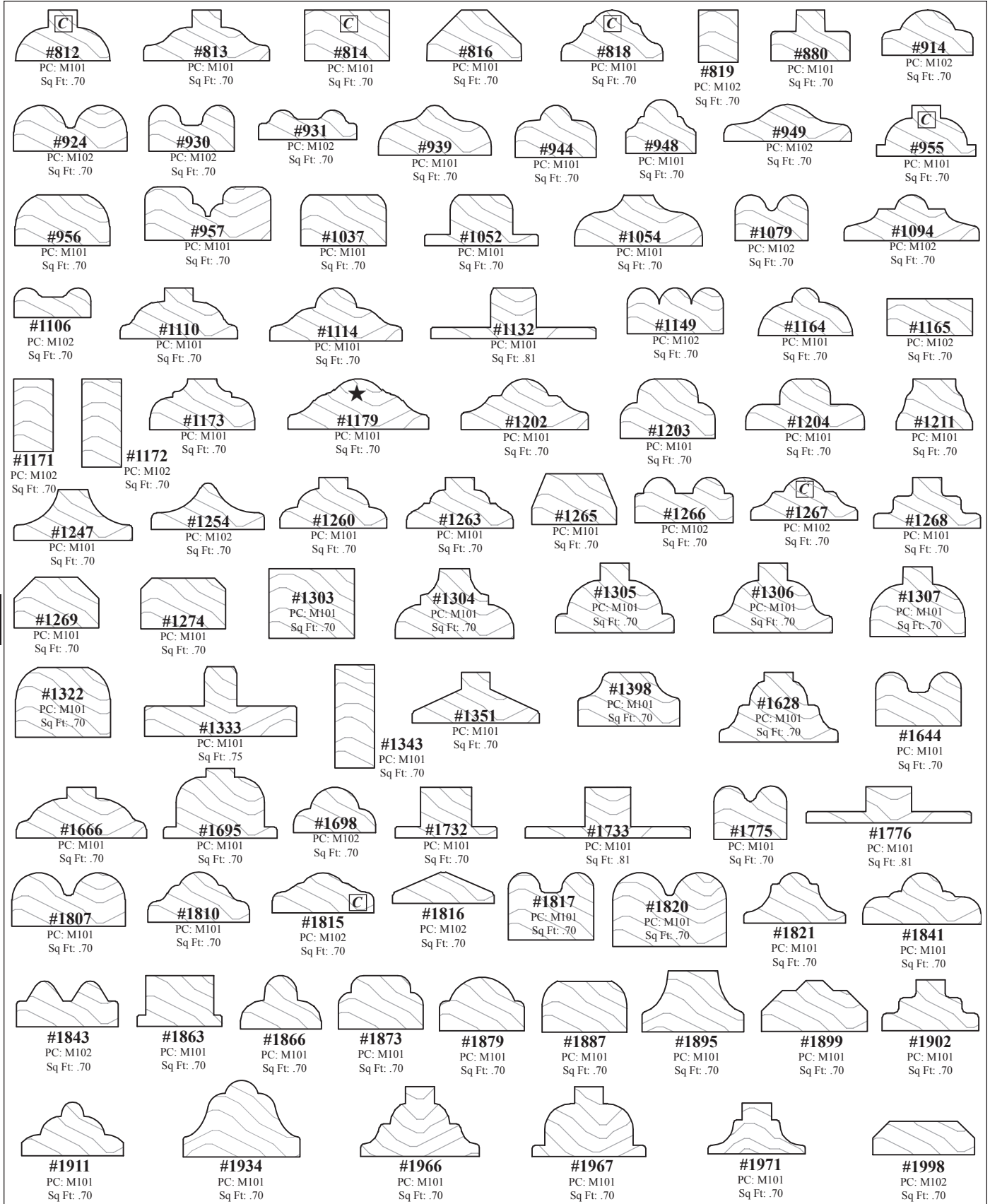















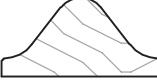



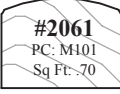



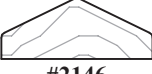



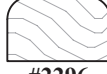

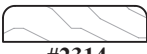





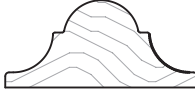





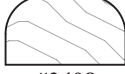

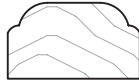



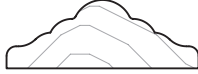

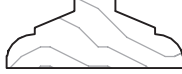

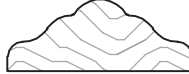
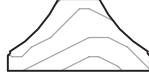
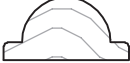
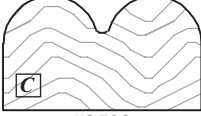

Mullion Stock Molding

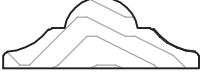

► For PRICING ► See Section N6 in our Wholesale Pricing Catalog.

Mullion Stock Molding

Moldings

 #2006 PC: M101 Sq Ft: .70	 #2008 PC: M102 Sq Ft: .70	 #2009 PC: M102 Sq Ft: .81	 #2014 PC: M101 Sq Ft: .70	 #2015 PC: M101 Sq Ft: .70	 #2016 PC: M101 Sq Ft: .70	 #2017 PC: M101 Sq Ft: .70		
 #2018 PC: M102 Sq Ft: .70	 #2038 PC: M101 Sq Ft: .70	 #2043 PC: M102 Sq Ft: .70	 #2044 PC: M101 Sq Ft: .70	 #2045 PC: M101 Sq Ft: .70	 #2061 PC: M101 Sq Ft: .70	 #2062 PC: M101 Sq Ft: .70	 #2063 PC: M101 Sq Ft: .70	 #2099 PC: M101 Sq Ft: .70
 #2146 PC: M102 Sq Ft: .70	 #2148 PC: M101 Sq Ft: .70	 #2149 PC: M101 Sq Ft: .70	 #2194 PC: M102 Sq Ft: .70	 #2296 PC: M101 Sq Ft: .70	 #2298 PC: M102 Sq Ft: .70	 #2314 PC: M102 Sq Ft: .70		
 #2324 PC: M101 Sq Ft: .86	 #2325 PC: M101 Sq Ft: .70	 #2370 PC: 101 Sq Ft: .70	 #2374 PC: M101 Sq Ft: .70	 #2375 PC: M101 Sq Ft: .70	 #2376 PC: M101 Sq Ft: .70			
 #2377 PC: M101 Sq Ft: .70	 #2380 PC: M101 Sq Ft: .81	 #2384 PC: M101 Sq Ft: .70	 #2387 PC: M101 Sq Ft: .92	 #2399 PC: M101 Sq Ft: .70	 #2406 PC: M101 Sq Ft: .70			
 #2407 PC: M101 Sq Ft: .80	 #2408 PC: M101 Sq Ft: .70	 #2409 PC: M101 Sq Ft: .70	 #2437 PC: M101 Sq Ft: .70	 #2438 PC: M102 Sq Ft: .70	 #2439 PC: M101 Sq Ft: .70			
 #2452 PC: M101 Sq Ft: .70	 #2463 PC: M101 Sq Ft: .70	 #2469 PC: M101 Sq Ft: .70	 #2472 PC: M102 Sq Ft: .70	 #2473 PC: M101 Sq Ft: .70	 #2474 PC: M101 Sq Ft: .70			
 #2493 PC: M101 Sq Ft: .70	 #2494 PC: M101 Sq Ft: .97	 #2495 PC: M101 Sq Ft: .70	 #2504 PC: M101 Sq Ft: .70	 #2506 PC: M101 Sq Ft: .70	 #2507 PC: M101 Sq Ft: .70			
 #2509 PC: M101 Sq Ft: .70	 #2512 PC: M101 Sq Ft: .70	 #2513 PC: M101 Sq Ft: .70	 #2514 PC: M101 Sq Ft: .70	 #2527 PC: M101 Sq Ft: .70	 #2529 PC: M102 Sq Ft: .70			
 #2551 PC: 101 Sq Ft: .70	 #2552 PC: M101 Sq Ft: .70	 #2557 PC: M101 Sq Ft: .83	 #2581 PC: M102 Sq Ft: .70	 #2582 PC: M102 Sq Ft: .70				

N

► For PRICING ► See Section N6 in our Wholesale Pricing Catalog.

Moldings

Mullion Stock Molding

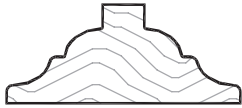

#2587
PC: M101
Sq Ft: .81



#2589
PC: M101
Sq Ft: .70

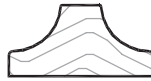

#2590
PC: M101
Sq Ft: .70



#2591
PC: M102
Sq Ft: .70

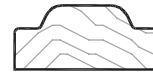

#2595
PC: M101
Sq Ft: .70



#2607
PC: M102
Sq Ft: .70

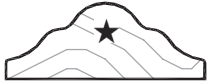

#2611
PC: M101
Sq Ft: .70



#2619
PC: M101
Sq Ft: .70

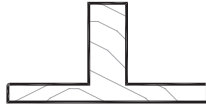

#2620
PC: M101
Sq Ft: .70

N

► For PRICING ► See Section N6 in our Wholesale Pricing Catalog.



1-800-237-1326

WalzCraft®

www.WalzCraft.com

N

Moldings

Column Molding

Half & Quarter Round Column Moldings - Smooth

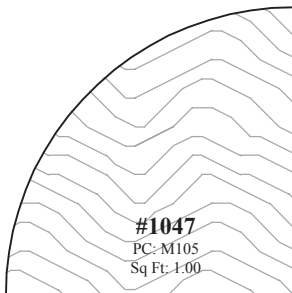
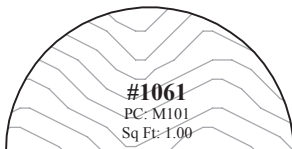
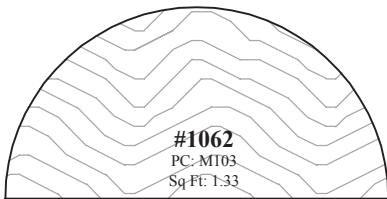
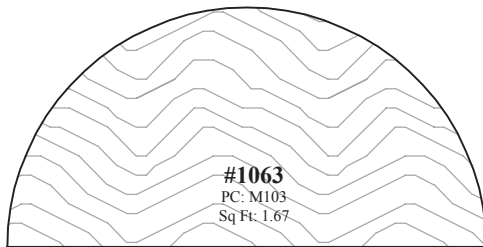
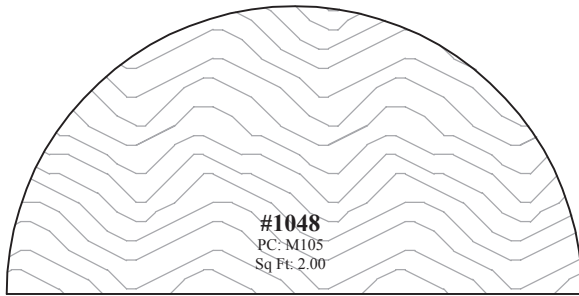

Half Round Column Moldings - Reed

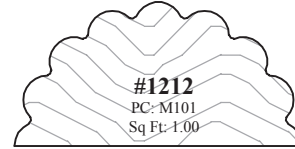
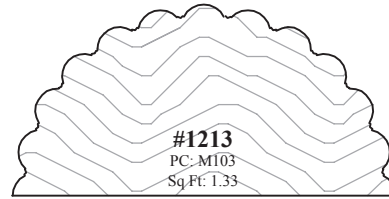
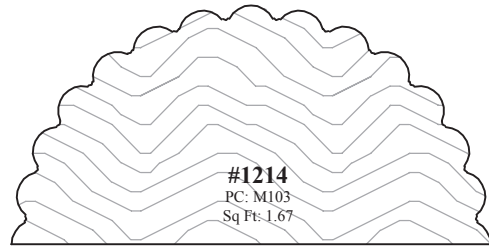
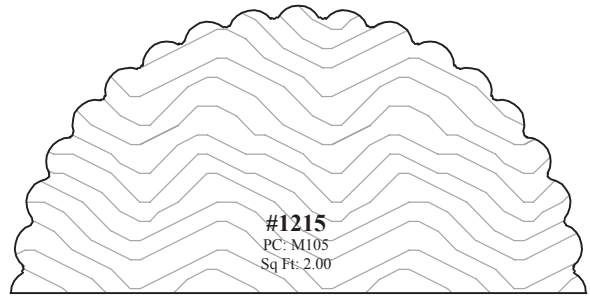

N

► For PRICING ► See Section N7 in our Wholesale Pricing Catalog.



Column Molding

Moldings

Half & Quarter Round Column Moldings - Large Flutes

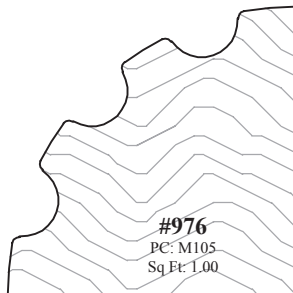
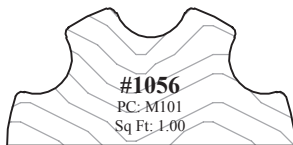
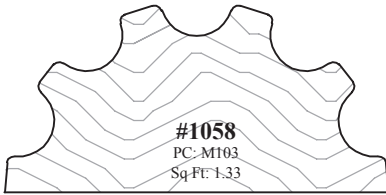
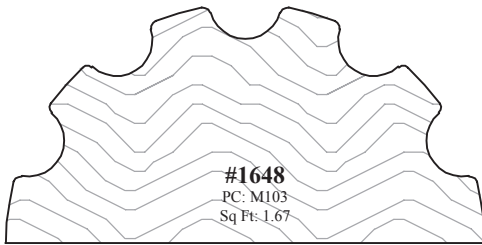
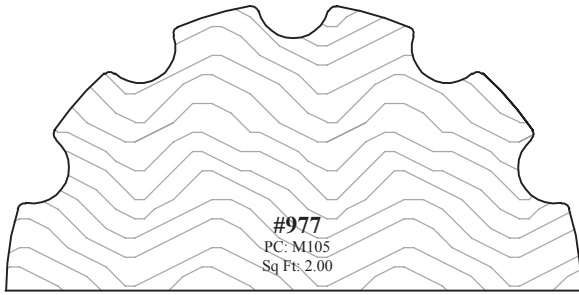

Half & Quarter Round Column Moldings - Small Flutes

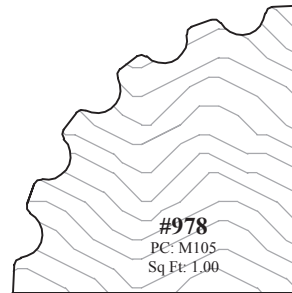
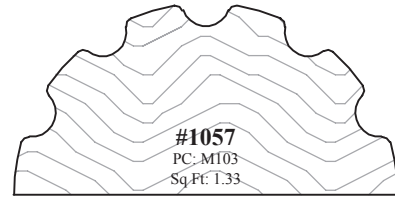
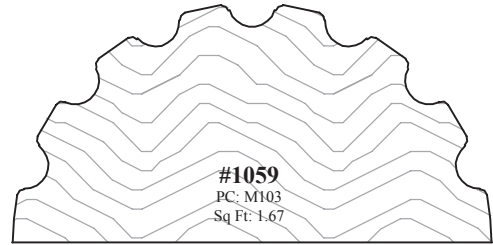
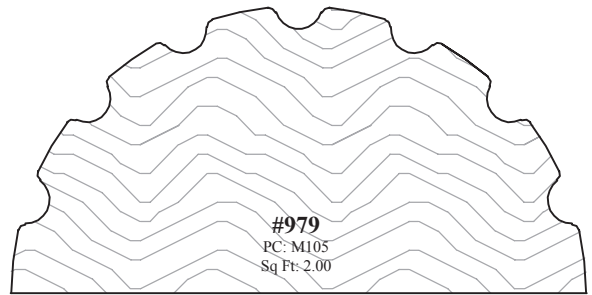

N

► For PRICING ► See Section N7 in our Wholesale Pricing Catalog.

1/4" Beaded Column Moldings

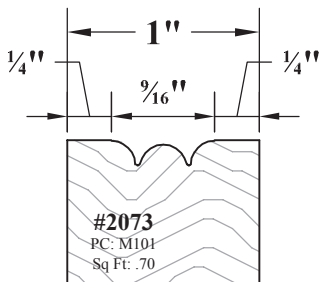
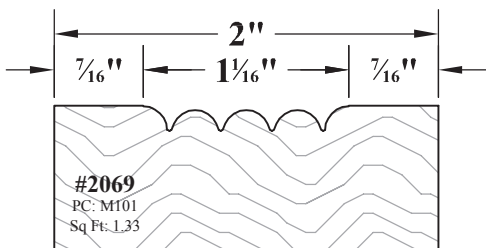
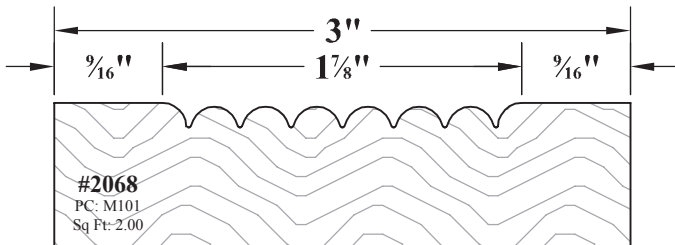
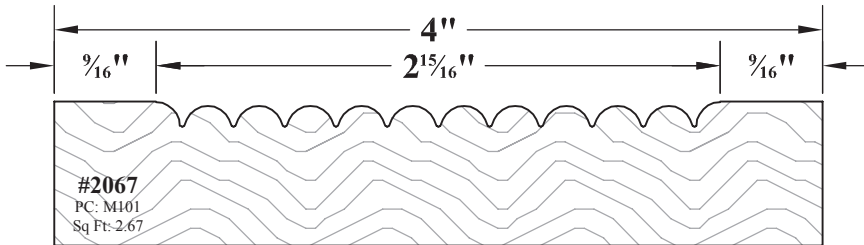
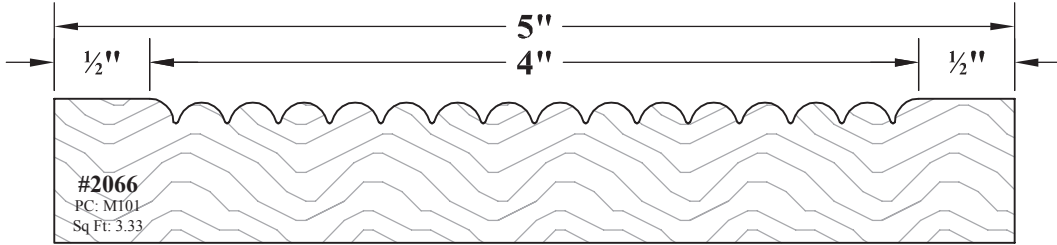
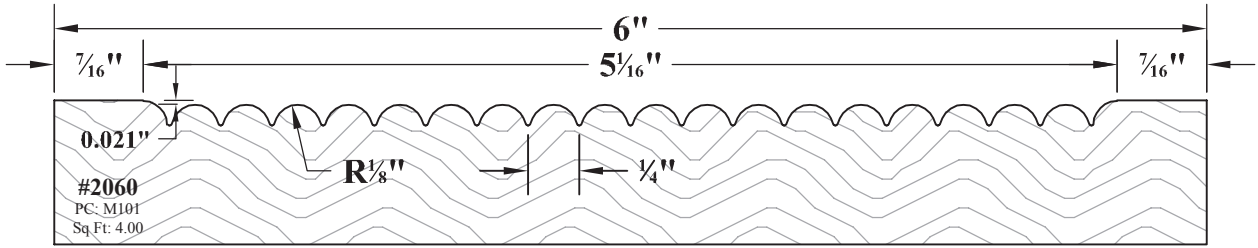

► For PRICING ► See Section N7 in our Wholesale Pricing Catalog.

3/8" Beaded Column Moldings

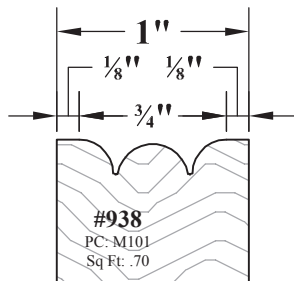
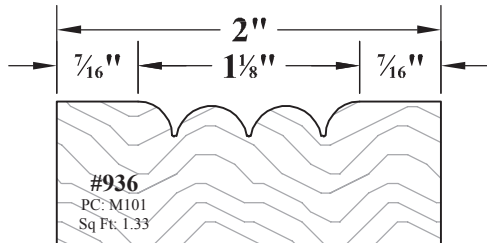
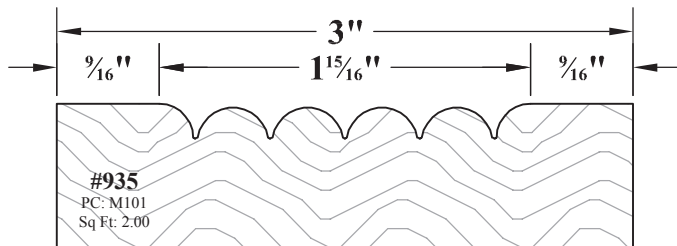
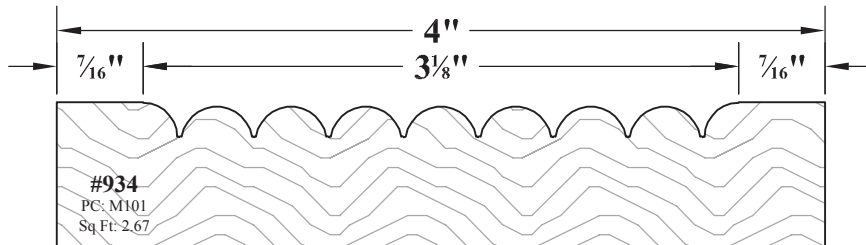
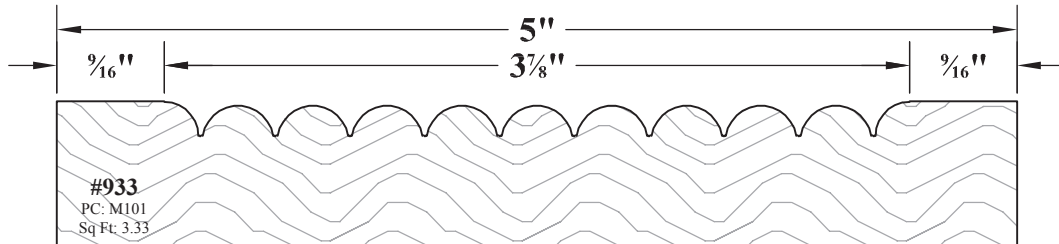
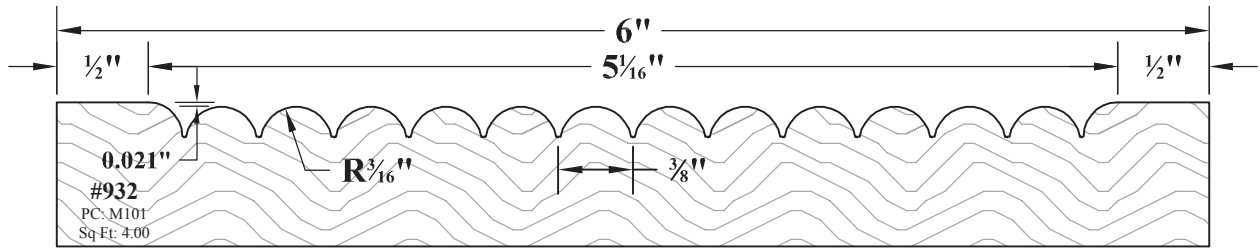

N

► For PRICING ► See Section N7 in our Wholesale Pricing Catalog.

Elliptical Column Moldings

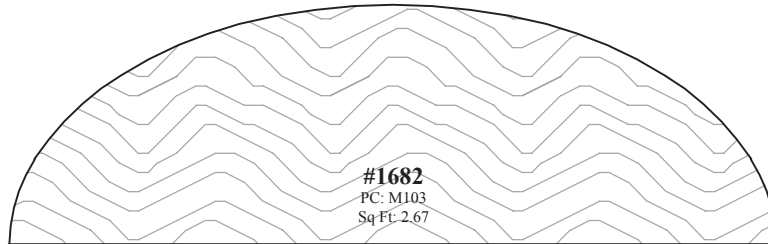
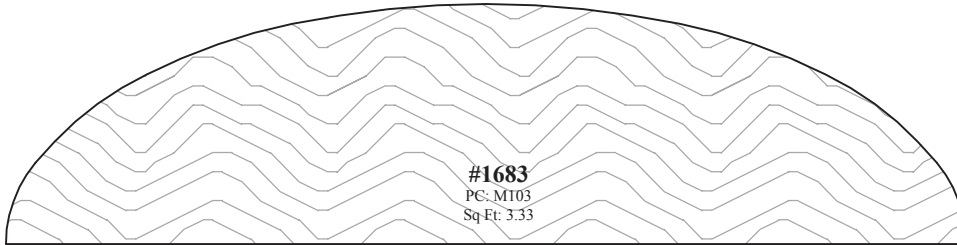
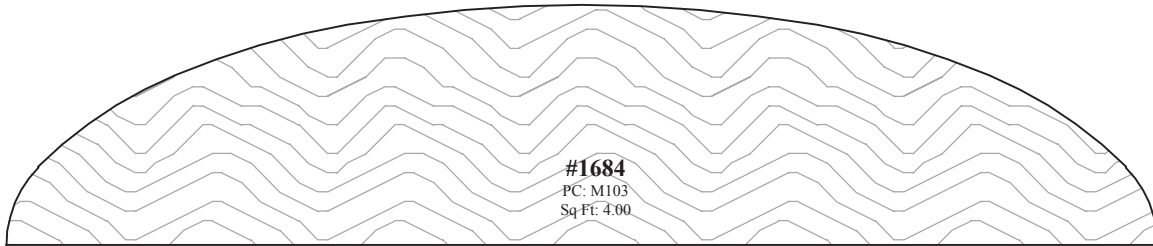

Pyramid Column Moldings

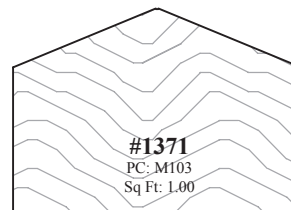
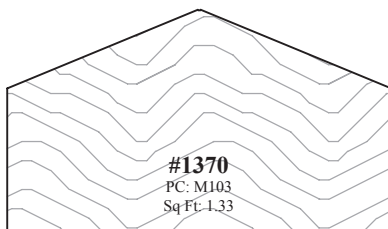
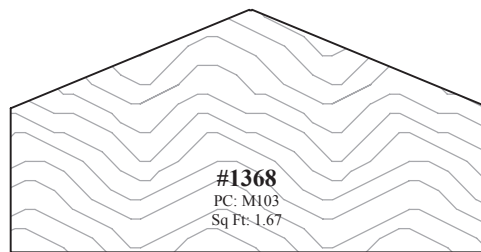
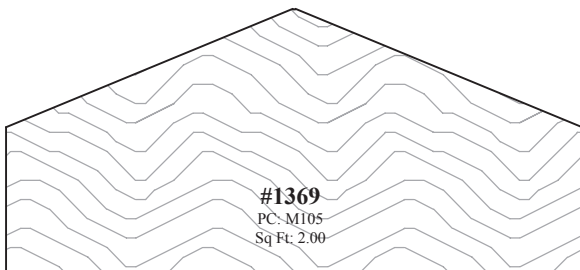

► For PRICING ► See Section N7 in our Wholesale Pricing Catalog.

Reed Column Moldings

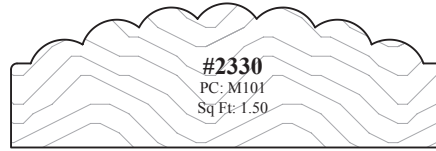
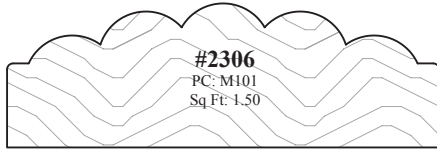

Miscellaneous Column Molding

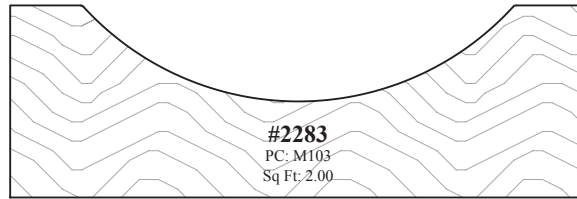

► For PRICING ► See Section N7 in our Wholesale Pricing Catalog.

Round Column Wrap Moldings - Smooth

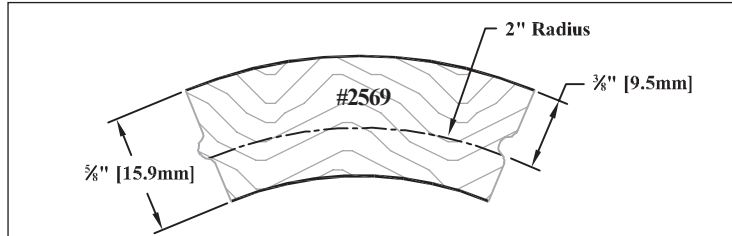
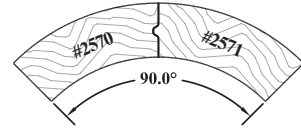
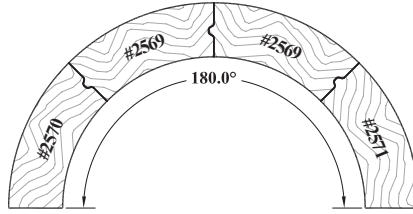
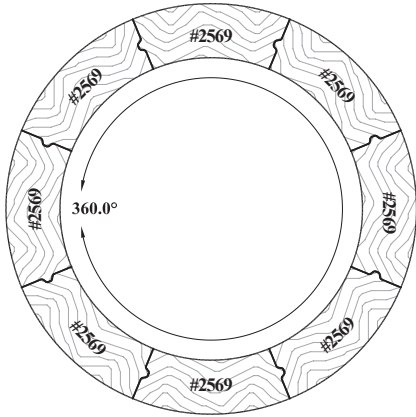

Note: The above application drawings are not drawn to scale.

****All radii measured 3/8" in from the face of molding.****

Column Wrap Applications

Number of Moldings Required

Curve in Degrees	2" Radius	3" Radius	4" Radius	5" Radius	6" Radius	7" Radius	8" Radius	9" Radius
45°	1	2	2	2	2	2	3	3
90°	2	4	4	4	4	4	6	6
135°	3	6	6	6	6	6	9	9
180°	4	8	8	8	8	8	12	12
225°	5	10	10	10	10	10	15	15
270°	6	12	12	12	12	12	18	18
315°	7	14	14	14	14	14	21	21
360°	8	16	16	16	16	16	24	24

2" Radius - Smooth

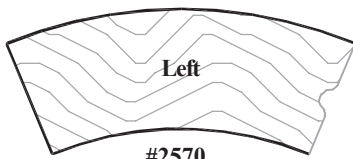

#2570
PC: M101
Sq Ft: 1.21

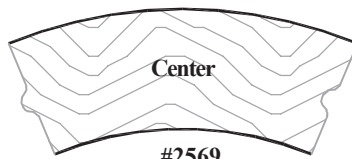

#2569
PC: M101
Sq Ft: 1.21

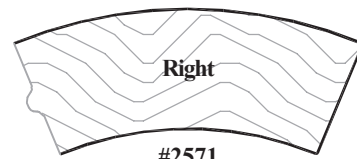

#2571
PC: M101
Sq Ft: 1.21

3" Radius - Smooth

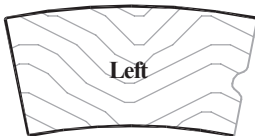

#2567
PC: M101
Sq Ft: .88

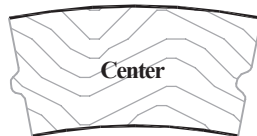

#2566
PC: M101
Sq Ft: .88

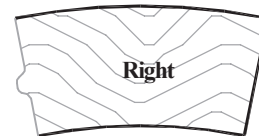

#2568
PC: M101
Sq Ft: .88

► **For PRICING** ► See Section N7 in our Wholesale Pricing Catalog.

Column Molding

Moldings

4" Radius - Smooth



Left

#2574
PC: M101
Sq Ft: 1.14

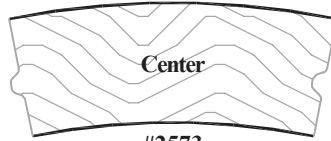

Center

#2573
PC: M101
Sq Ft: 1.14



Right

#2575
PC: M101
Sq Ft: 1.14

5" Radius - Smooth

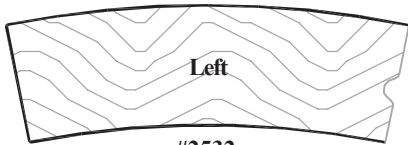

Left

#2532
PC: M101
Sq Ft: 1.40

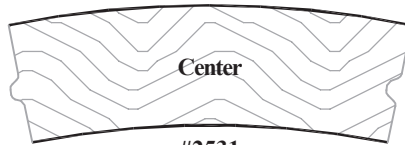

Center

#2531
PC: M101
Sq Ft: 1.40



Right

#2533
PC: M101
Sq Ft: 1.40

6" Radius - Smooth

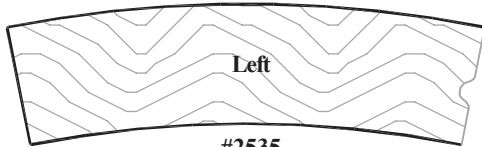

Left

#2535
PC: M101
Sq Ft: 1.66

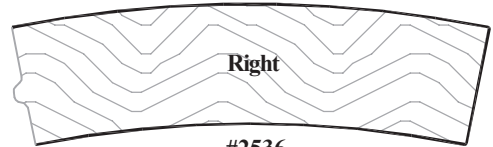

Right

#2536
PC: M101
Sq Ft: 1.66

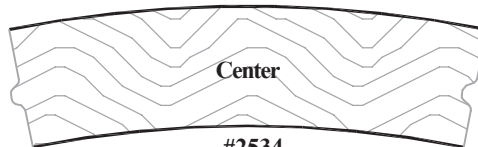

Center

#2534
PC: M101
Sq Ft: 1.66

7" Radius - Smooth

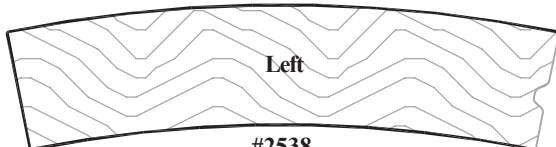

Left

#2538
PC: M101
Sq Ft: 1.92



Right

#2539
PC: M101
Sq Ft: 1.92

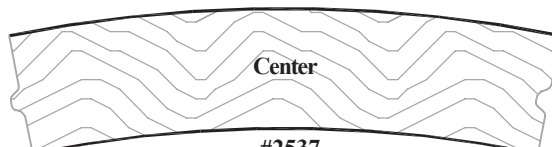

Center

#2537
PC: M101
Sq Ft: 1.92

► For PRICING ► See Section N7 in our Wholesale Pricing Catalog.

8" Radius - Smooth

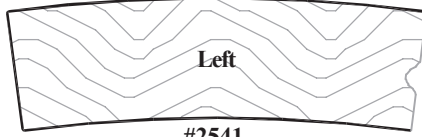

Left

#2541
PC: M101
Sq Ft: 1.46

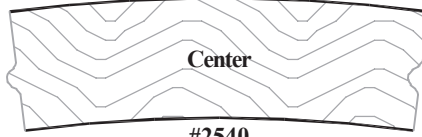

Center

#2540
PC: M101
Sq Ft: 1.47

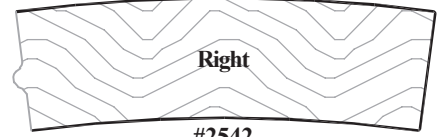

Right

#2542
PC: M101
Sq Ft: 1.47

9" Radius - Smooth



Left

#2544
PC: M101
Sq Ft: 1.63

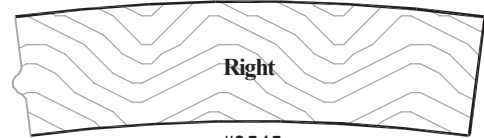

Right

#2545
PC: M101
Sq Ft: 1.64

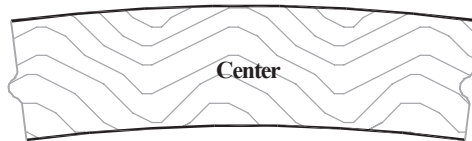

Center

#2543
PC: M101
Sq Ft: 1.64

► For PRICING ► See Section N7 in our Wholesale Pricing Catalog.



Round Column Wrap Moldings - Fluted

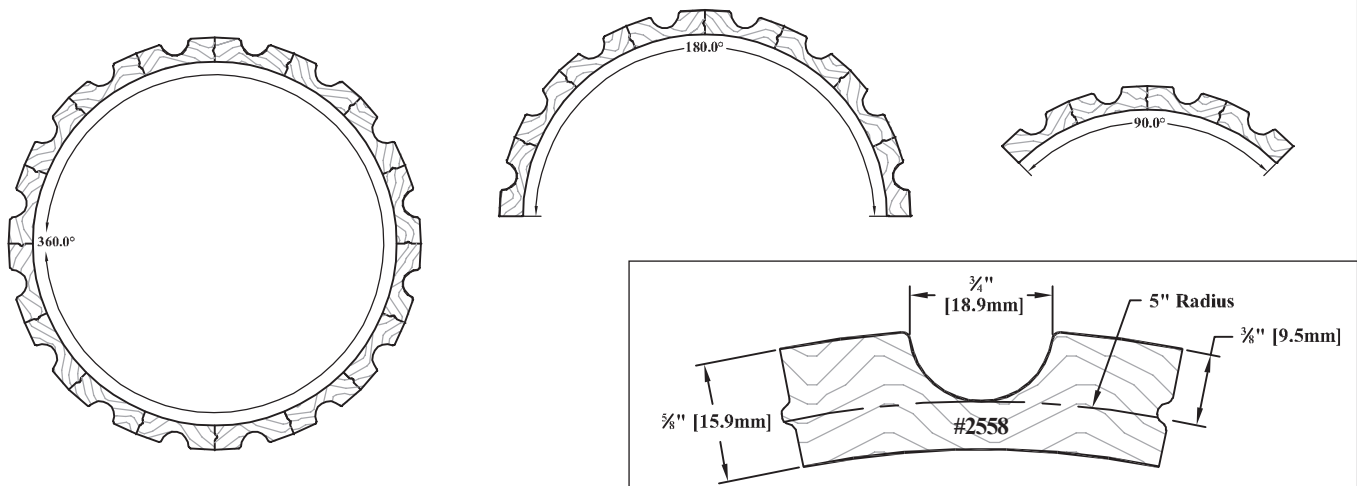

Note: The above application drawings are not drawn to scale.

All radii measured 3/8" in from the face of molding.

Column Wrap Applications	Number of Moldings Required
Curve in Degrees	5" Radius
45°	2
90°	4
135°	6
180°	8
225°	10
270°	12
315°	14
360°	16

5" Radius - Fluted

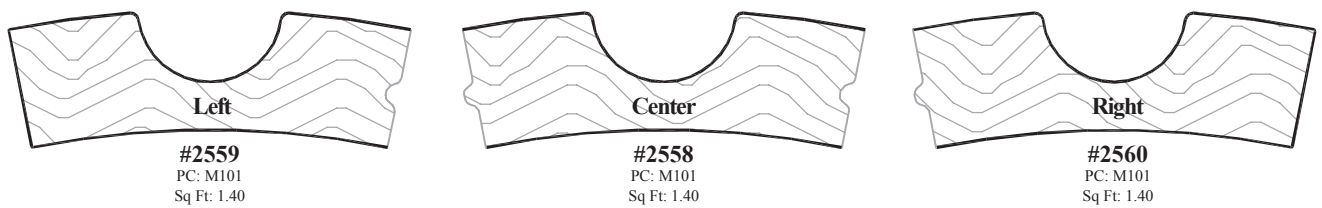

► For PRICING ► See Section N7 in our Wholesale Pricing Catalog.

Wainscot Cap / Backband Moldings

** The addition of a Wainscot Cap Molding provides a finished look to wainscot panels. **

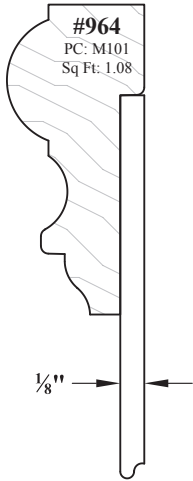

#964
PC: M101
Sq Ft: 1.08

End View
1/8" Thick Plywood

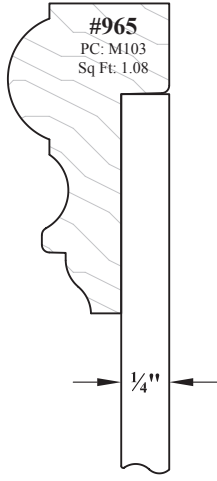

#965
PC: M103
Sq Ft: 1.08

End View
1/4" Thick Plywood

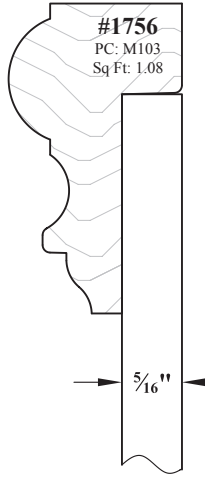

#1756
PC: M103
Sq Ft: 1.08

End View 5/16"
Tongue & Groove
Wainscot

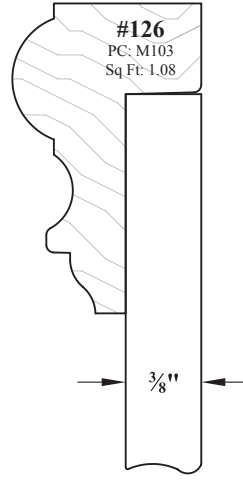

#126
PC: M103
Sq Ft: 1.08

End View 3/8"
Tongue & Groove
Wainscot

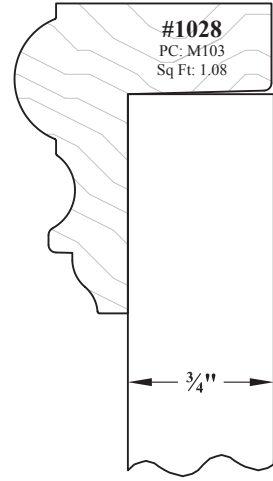

#1028
PC: M103
Sq Ft: 1.08

End View
3/4" Thick Wainscot

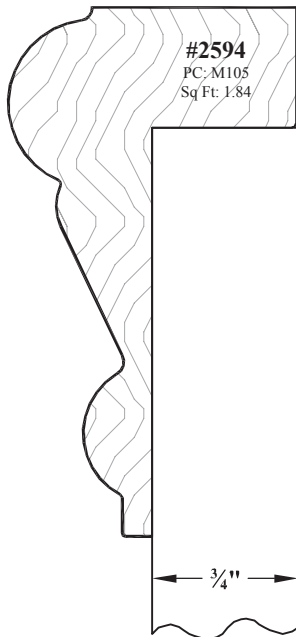

#2594
PC: M105
Sq Ft: 1.84

End View
3/4" Thick Wainscot

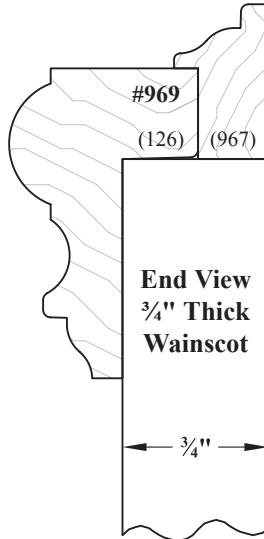

#969

(126) (967)

End View
3/4" Thick
Wainscot

3/4"

#969

PC: M103 + \$10.00 for Assembly
Sq Ft: 1.61

Two pieces, assembled
by WalzCraft.

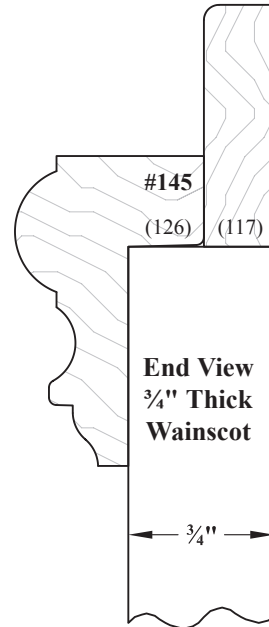

#145

(126) (117)

End View
3/4" Thick
Wainscot

3/4"

#145

PC: M103 + \$10.00 for Assembly
Sq Ft: 1.92

Two pieces, assembled
by WalzCraft.

► For PRICING ► See Section N8 in our Wholesale Pricing Catalog.

Wainscot Molding

Moldings

Wainscot Cap / Backband Moldings

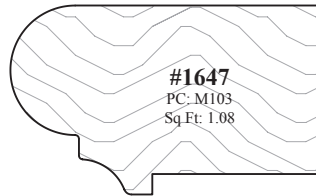
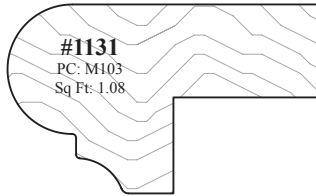
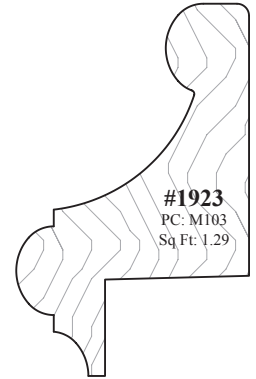
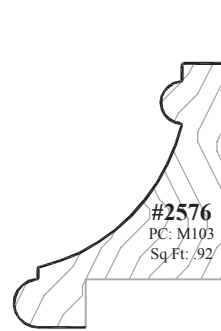
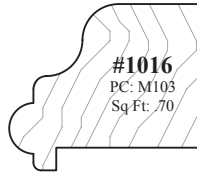
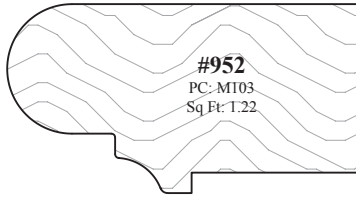

Wainscot Cap / Backband Moldings...continued

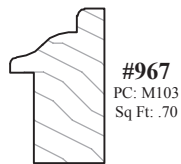
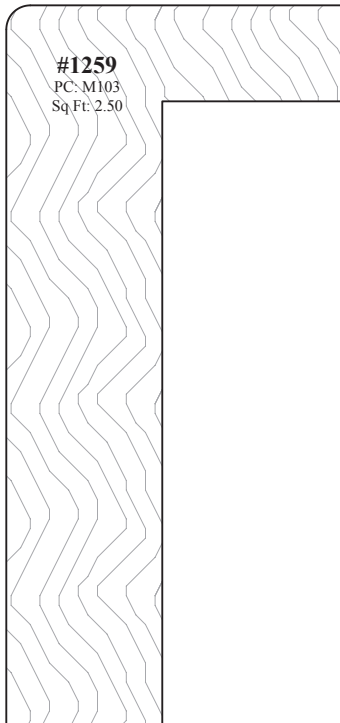

Wainscot Inside Edge Applied Moldings

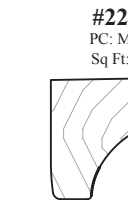
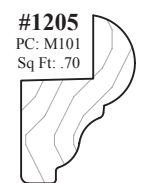
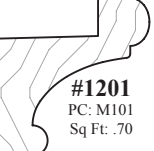
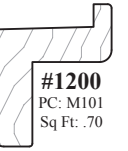
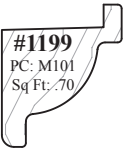
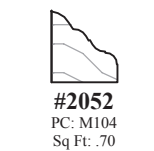
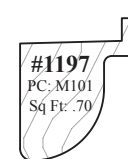
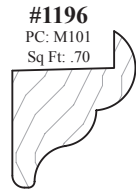
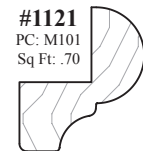
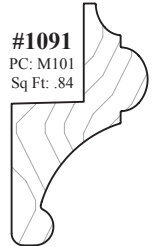
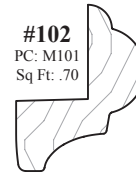
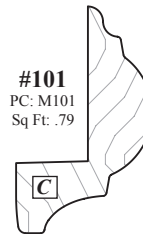

Molding #1200: Designed to accept an additional 3/8" applied molding, such as the #918 (Section N13).

► For PRICING ► See Section N8 in our Wholesale Pricing Catalog.

Moldings

Miscellaneous Moldings

Color Block Molding

- Designed to be cut to size and finished by our customers, to use as color block samples.
- When cut in heights of 5 $\frac{5}{8}$ " these blocks will fit in CD racks for perfect storage and accessibility.

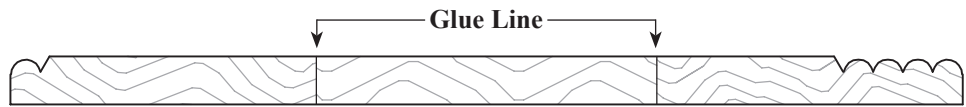

#1288
PC: M102
Sq Ft: 3.31

Door Jamb Stop Molding



#117
PC: M101
Sq Ft: .84

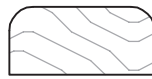

#1652
PC: M101
Sq Ft: .70



#972
PC: M101
Sq Ft: .84



#1619
PC: M102
Sq Ft: .84

Window Sill Moldings

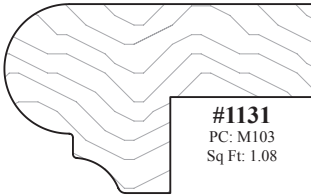

#1131
PC: M103
Sq Ft: 1.08

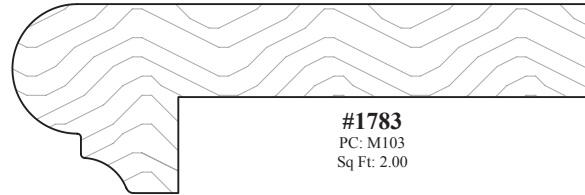

#1783
PC: M103
Sq Ft: 2.00

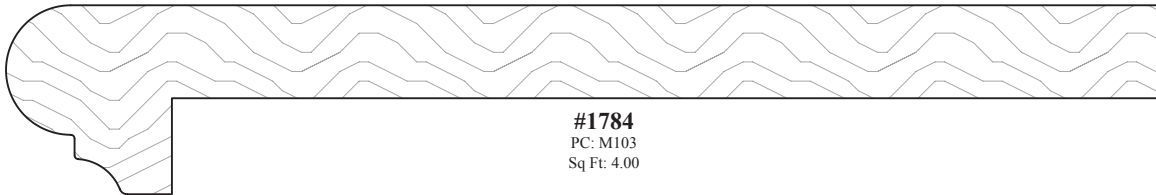

#1784
PC: M103
Sq Ft: 4.00

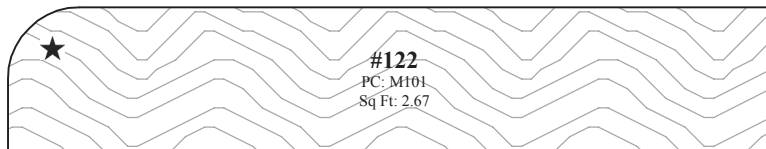

#122
PC: M101
Sq Ft: 2.67

Astragal Molding



#992
PC: M101
Sq Ft: .84



#996
PC: M101
Sq Ft: .84



#993
PC: M101
Sq Ft: .84



#994
PC: M101
Sq Ft: .84

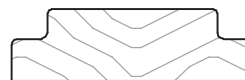

#995
PC: M101
Sq Ft: .84



#2147
PC: M101
Sq Ft: .84

► For PRICING ► See Section N9 in our Wholesale Pricing Catalog.

Miscellaneous Molding

Moldings

Louvered Slat Molding (Non-Operable)

1" Molding



#1051
PC: M102
Sq Ft: .70

1 1/4" Molding



#2436
PC: M102
Sq Ft: .83

1 1/2" Molding



#1245
PC: M102
Sq Ft: 1.00

2" Molding



#1282
PC: M102
Sq Ft: 1.33

2 1/2" Molding



#2238
PC: M102
Sq Ft: 1.67

Louvered Slat Molding (Operable)

1" Molding

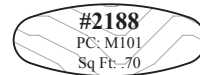

#2188
PC: M101
Sq Ft: .70

1 1/2" Molding

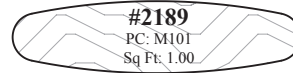

#2189
PC: M101
Sq Ft: 1.00

2" Molding

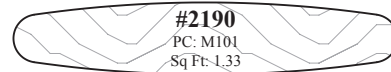

#2190
PC: M101
Sq Ft: 1.33

2 1/2" Molding

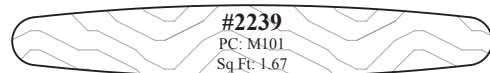

#2239
PC: M101
Sq Ft: 1.67

Operable Louver Actuator Molding



#2191
PC: M102
Sq Ft: .70

Half Lap Molding



#1658
PC: M101
Sq Ft: 2.62

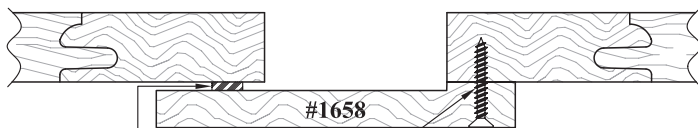

#1658
Rubber Door Bumper
Supplied By Customer Wood Screw Supplied
By Customer

Panel Splice Molding

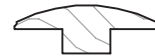

#1286
PC: M102
Sq Ft: .70

Dowel Molding

1" Diameter



#2301
PC: M103
Sq Ft: .70

3/4" Diameter

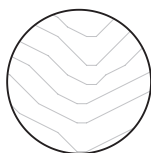

#2304
PC: M101
Sq Ft: .70

1/2" Diameter



#2303
PC: M101
Sq Ft: .70

3/8" Diameter



#985
PC: M101
Sq Ft: .70

1/4" Diameter



#2577
PC: M102
Sq Ft: .70

Square Peg Molding

1/2" Square

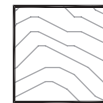

#2610
PC: M101
Sq Ft: .70

3/8" Square



#1185
PC: M101
Sq Ft: .70

1/4" Square



#2609
PC: M102
Sq Ft: .70

▶ For PRICING ▶ See Section N9 in our Wholesale Pricing Catalog.

Moldings

Miscellaneous Molding

Beaded Molding



#831
PC: M102
Sq Ft: .70

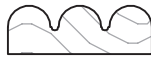

#832
PC: M102
Sq Ft: .70



#833
PC: M102
Sq Ft: .70



#1133
PC: M102
Sq Ft: 1.00

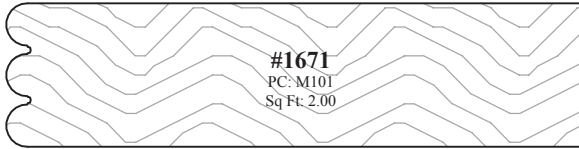

#1671
PC: M101
Sq Ft: 2.00

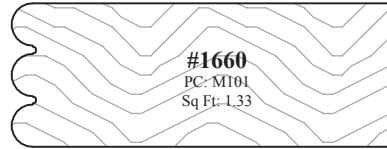

#1660
PC: M101
Sq Ft: 1.33

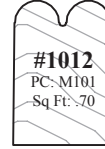

#1012
PC: M101
Sq Ft: .70



#1283
PC: M101
Sq Ft: .70

Inset Bead Molding

For 3/4" Doors



#825
PC: M101
Sq Ft: .70



#1334
PC: M101
Sq Ft: .70

Designed to be pin-nailed to the inside edge of a face frame opening when using inset doors.

For 1" Doors



#834
PC: M103
Sq Ft: .70



#1352
PC: M103
Sq Ft: .70

Miscellaneous Molding



#1846
PC: M103
Sq Ft: .70

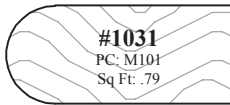

#1031
PC: M101
Sq Ft: .79

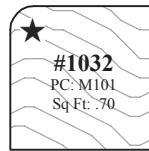

#1032
PC: M101
Sq Ft: .70

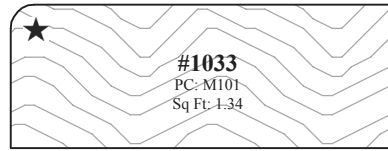

#1033
PC: M101
Sq Ft: 1.34

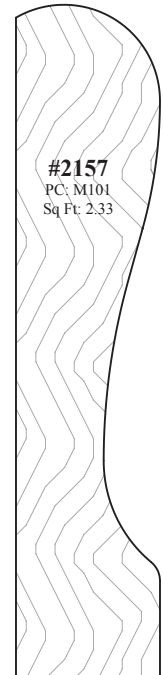

#2157
PC: M101
Sq Ft: 2.33

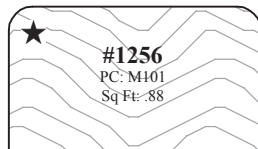

#1256
PC: M101
Sq Ft: .88

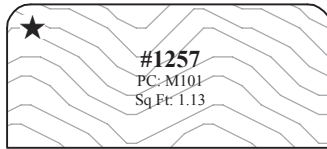

#1257
PC: M101
Sq Ft: 1.13

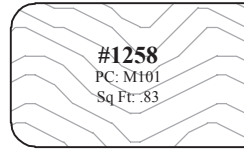

#1258
PC: M101
Sq Ft: .83

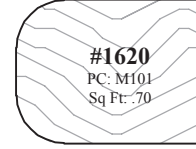

#1620
PC: M101
Sq Ft: .70

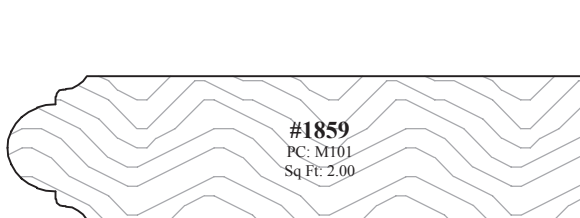

#1859
PC: M101
Sq Ft: 2.00

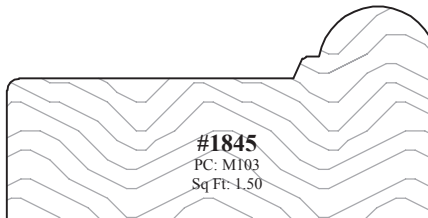

#1845
PC: M103
Sq Ft: 1.50

► For PRICING ► See Section N9 in our Wholesale Pricing Catalog.

Miscellaneous Molding

Moldings

Finger Pull Molding (5/8" Thick Doors)

- Typically the #2241, #2242 & #2243 moldings would be paired with a 5/8" thick Melamine Door or Drawer Front. See **Section F8** for molding application drawings.

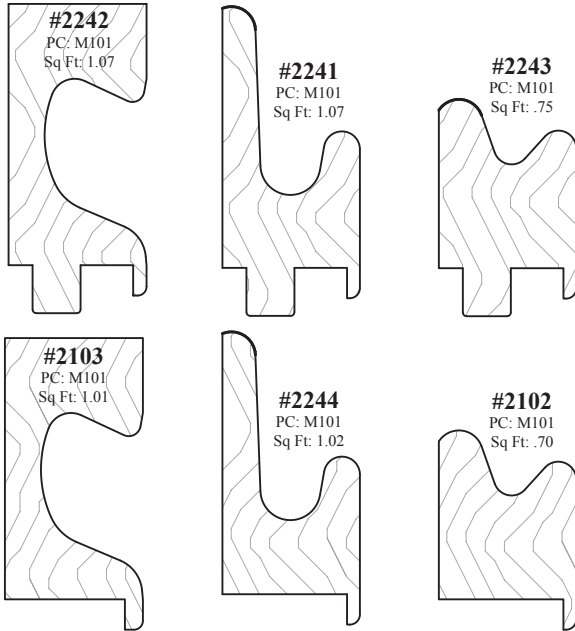

Finger Pull Molding (3/4" Thick Doors)

- Typically the #1803, #1804 & #2211 moldings would be paired with a 3/4" thick Veneered, MDF or RTF Slab Door or Drawer Front. See **Section F8** for molding application drawings.

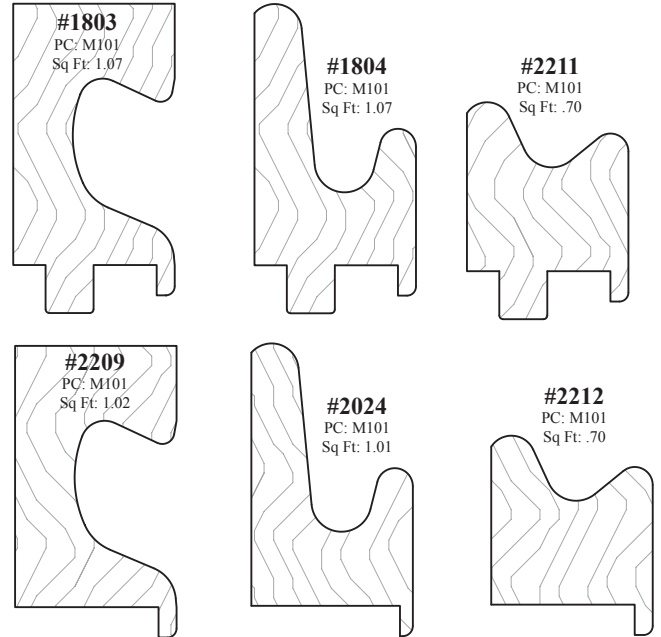

Shelf Bull Nose Molding

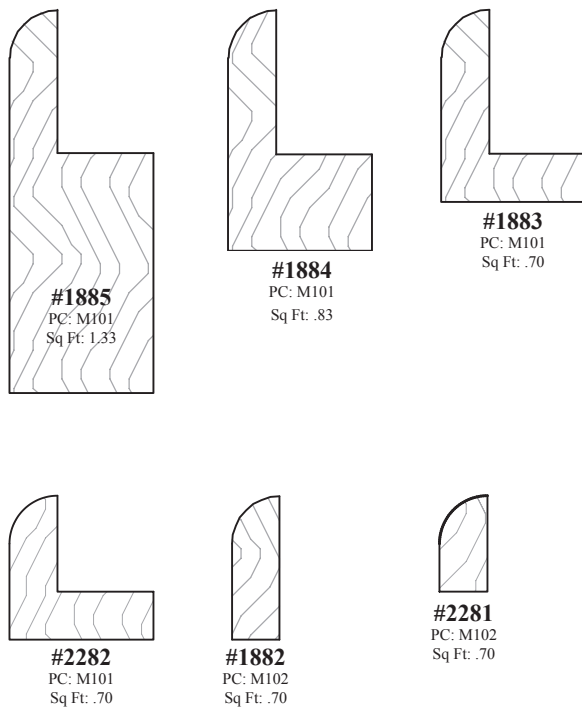

Countertop Edge Molding

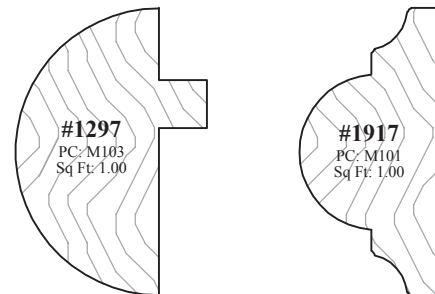

Edgeband Molding

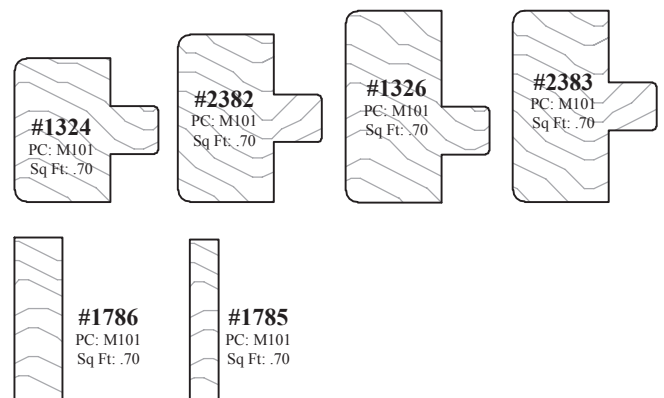

► For PRICING ► See Section N9 in our Wholesale Pricing Catalog.

Wood Retainer Molding

See Section B12 for Cut to Size Price Classes

For 3/4" Doors

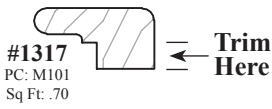

For 1" Doors

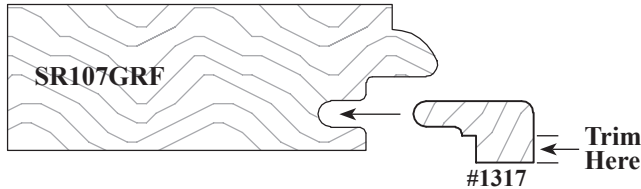
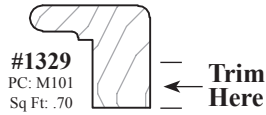

For 3/4" Doors

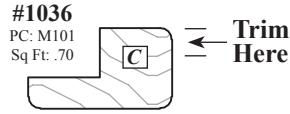

For 1" Doors

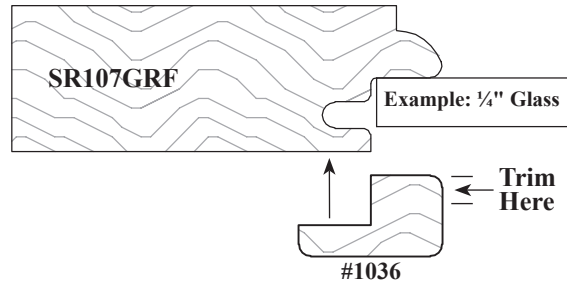
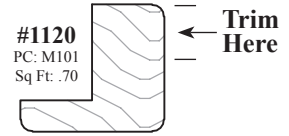

Wood Tenon Filler Molding

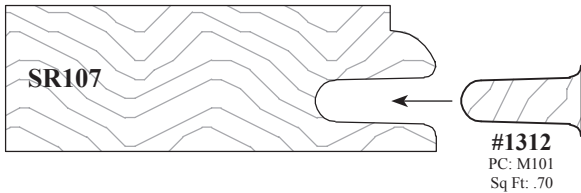

"GRF" Wood Filler Molding

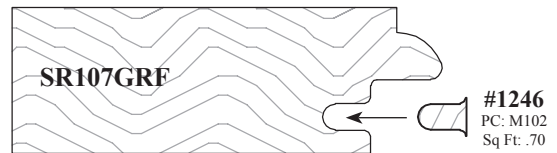

Wood Retainer Molding (8' Lengths)

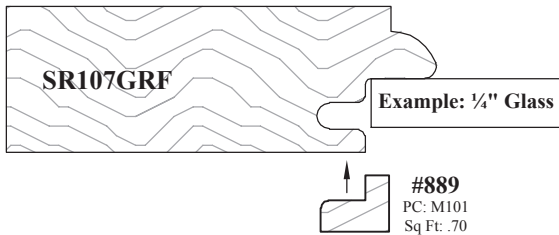

Wood Retainer Molding



#2090
PC: M102
Sq Ft: .70

Not available as a precision cut molding.

Wood Retainer Molding Notes

1)	Pricing	Please see <i>Section N9</i> of the Wholesale Pricing Catalog.
2)	#1317 and #1329 Moldings	Fit into the GRF cut of the stile and rail profile and are designed to be used with 1/8" materials.
3)	#1036 and #1120 Moldings	Designed for use as a wood retainer molding that is fastened to the rear of the 3/4" frame and can be trimmed to size, to accommodate materials thicker than 1/8". The #1120 molding would be used for 1" thick frames.
4)	#1312 Molding	The illustration above shows an example of how this molding fits into the tenon of the stile and rail profile. Designed to fill the tenon PPGC (Panel Plow Groove Cut) of any stile and rail profile, for your custom frame requirements. For use with 3/4" or 1" thick doors.
5)	#1246 Molding	The illustration above shows an example of how this molding fits into the GRF groove of the stile and rail profile. Designed to fill the void for the GRF groove in the stiles and rails of frame and mullion doors. For use with 3/4" or 1" thick doors.
6)	#889 Molding	Designed for use with 1/4" glass. Not available as a precision cut molding.

Miscellaneous Molding

Moldings

GRF Extension Molding (Used with some applied moldings)

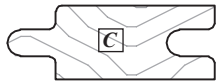

#888
PC: M101
Sq Ft: .72

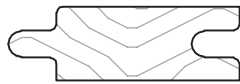

#962
PC: M101
Sq Ft: .80

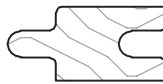

#963
PC: M101
Sq Ft: .70

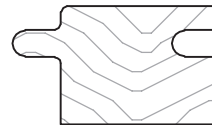

#1135
PC: M101
Sq Ft: .72

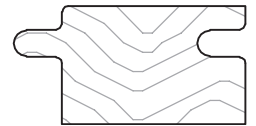

#1136
PC: M101
Sq Ft: .80

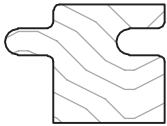

#1137
PC: M101
Sq Ft: .70



#1716
PC: M101
Sq Ft: 1.06

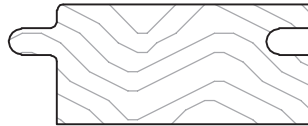

#1719
PC: M101
Sq Ft: 1.06

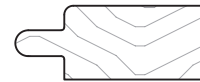

#2365
PC: M101
Sq Ft: 1.06

Chair Rail Molding

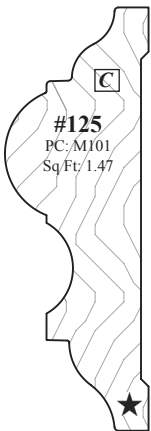

#125
PC: M101
Sq Ft: 1.47

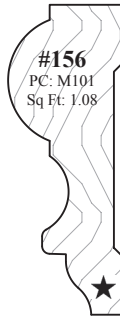

#156
PC: M101
Sq Ft: 1.08

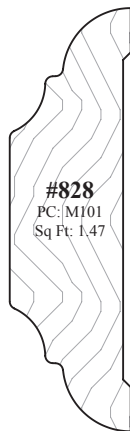

#828
PC: M101
Sq Ft: 1.47

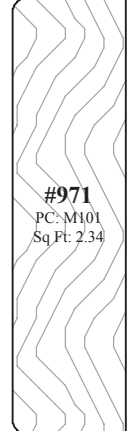

#971
PC: M101
Sq Ft: 2.34

Retail Price Tag Molding

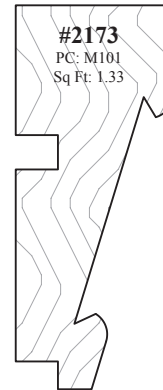

#2173
PC: M101
Sq Ft: 1.33

Drawer Glide Spacer Molding

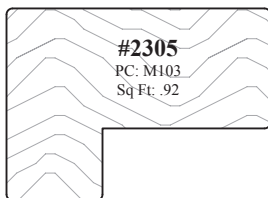

#2305
PC: M103
Sq Ft: .92

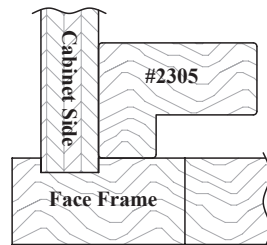

****Used to space drawer glide away from inside edge **
of face frame opening for hinge clearance.**

Step Molding

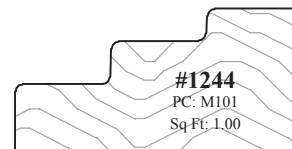

#1244
PC: M101
Sq Ft: 1.00

► For PRICING ► See Section N9 in our Wholesale Pricing Catalog.

Under Cabinet (Light Rail) & Over Cabinet Moldings

#1068
PC: M101
Sq Ft: 1.50

#1019
(1021)

#1019
PC: M101 + Assembly
Fee Sq Ft: 2.25
*Two pieces,
assembled by
WalzCraft.*

#1069
PC: M101
Sq Ft: 1.50

#1969
(864)

#1969
PC: M101 + Assembly
Fee Sq Ft: 2.51
*Two pieces,
assembled by
WalzCraft.*

#1676
(1021)

#1676
PC: M101 + Assembly
Fee Sq Ft: 2.25
*Two pieces,
assembled by
WalzCraft.*

#2086
PC: M101
Sq Ft: 1.0

#2087
PC: M101
Sq Ft: 1.17

#1021
PC: M101
Sq Ft: .75

#2088
(2087)

#2088
PC: M101 + Assembly
Fee Sq Ft: 2.17
*Two pieces, assembled
by WalzCraft.*

#2161
PC: M103
Sq Ft: 1.17

#1064
PC: M101
Sq Ft: 1.00

#1006
(864)

#1006
PC: M101 + Assembly
Fee Sq Ft: 2.01
*Two pieces,
assembled by
WalzCraft.*

#1017
(1021)

#1017
PC: M101 + Assembly
Fee Sq Ft: 1.75
*Two pieces,
assembled by
WalzCraft.*

#864
PC: M101
Sq Ft: 1.01

#1092
PC: M103
Sq Ft: 1.84

#1650
PC: M101
Sq Ft: 1.00

#1007
(864)

#1007
PC: M101 + Assembly
Fee Sq Ft: 2.02
*Two pieces,
assembled by
WalzCraft.*

#1018
(1021)

#1018
PC: M101 + Assembly
Fee Sq Ft: 1.75
*Two pieces,
assembled by
WalzCraft.*

#1904
PC: M101
Sq Ft: 1.34

► **For PRICING** ► See Section **N9** in our Wholesale Pricing Catalog.

Under Cabinet (Light Rail) & Over Cabinet Moldings...continued

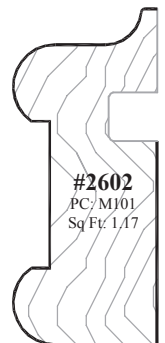
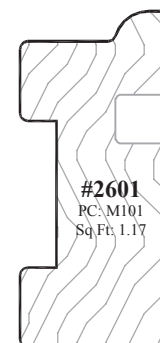
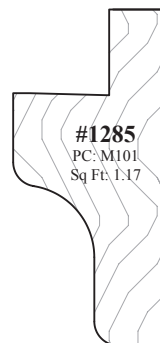
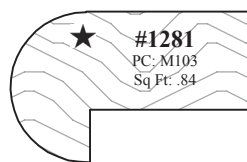
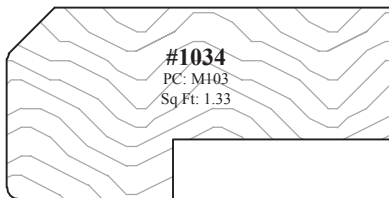
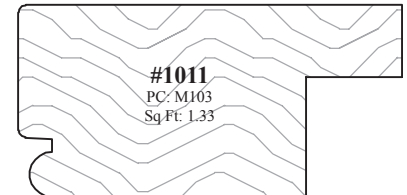
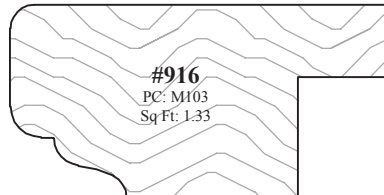
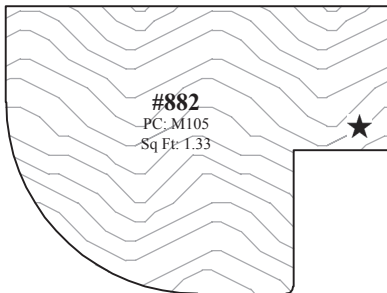
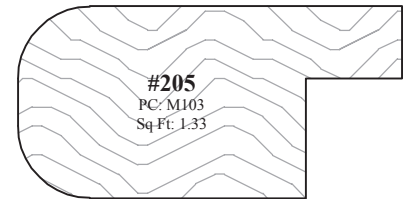
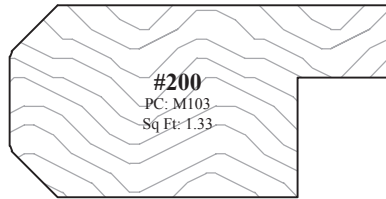
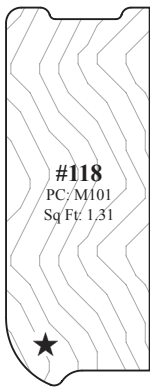
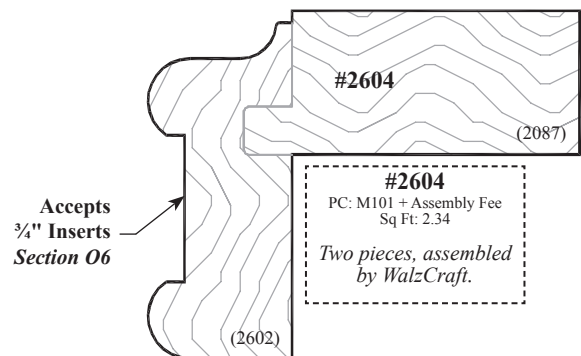
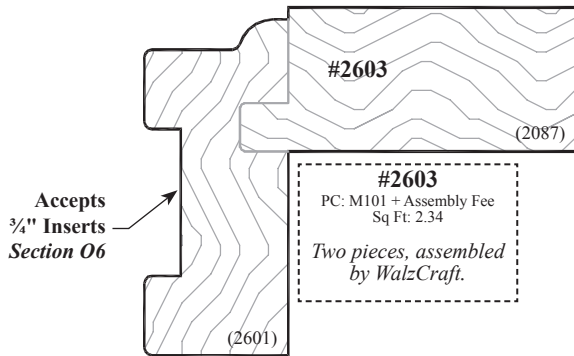

▶ For PRICING ▶ See Section N9 in our Wholesale Pricing Catalog.

Moldings

Miscellaneous Molding

Under Cabinet (Light Rail) & Over Cabinet Moldings...continued

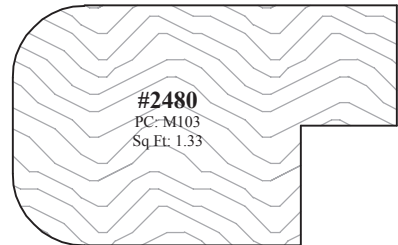
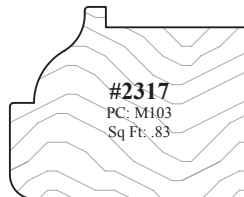
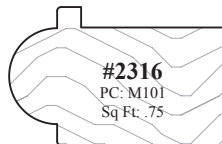
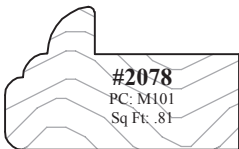
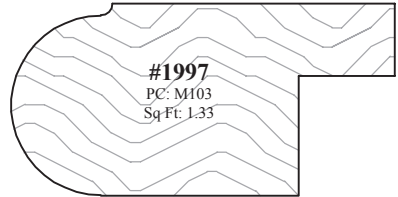
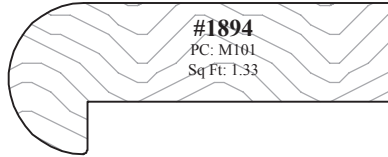
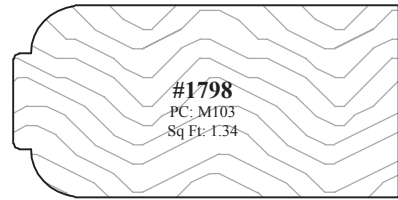
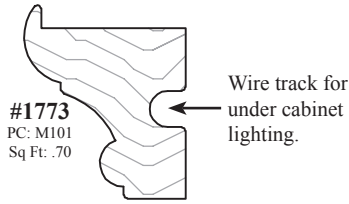
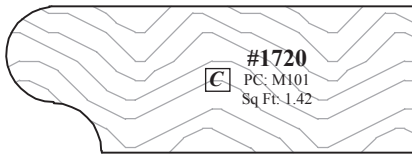
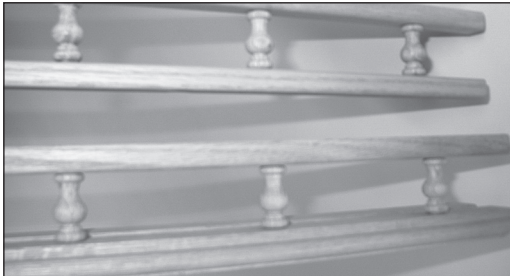

Plate Rail Molding



• Molding #2371 and #2372 do not come pre-drilled for spindles.

#141
PC: M101 + Assembly Fee
Sq Ft: 1.50
Multiple pieces assembled by WalzCraft.

#142
PC: M101 + Assembly Fee
Sq Ft: 2.50
Multiple pieces assembled by WalzCraft.

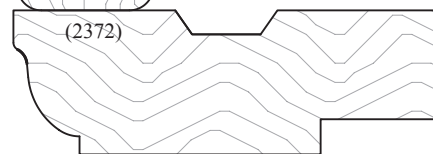
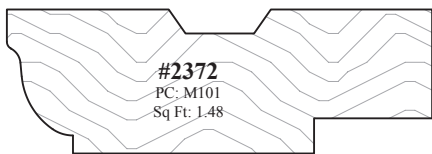
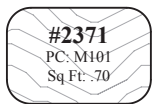

► For PRICING ► See Section N9 in our Wholesale Pricing Catalog.



Spice Rack Molding

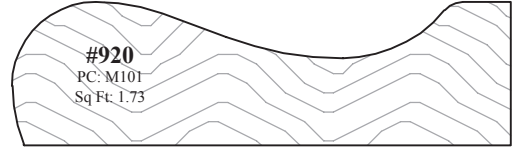
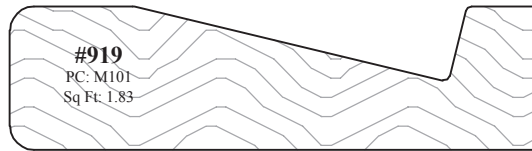
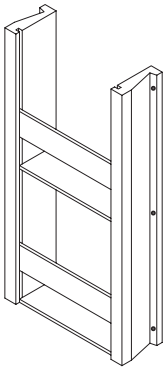

- The #919 and #920 moldings can be used to construct spice racks, church pew book holders, or other small shelving units.
- The example at right shows the #919 molding.
- 3/16" Refacing Stock works well for making the bottoms and fronts.
- See *page N2-3* for 3/16" Solid Wood Refacing Stock.

Tiered Spice Drawer Molding

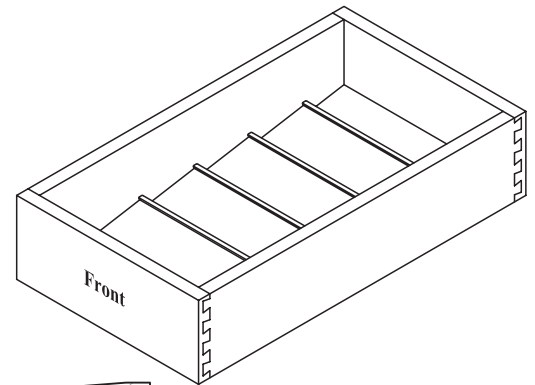
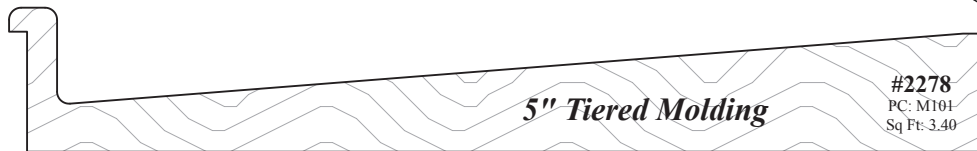

Drawer Box Divider Molding

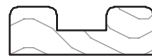
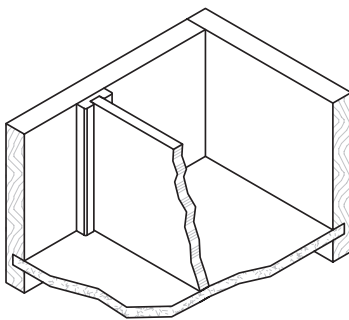

- Available in 8' lengths.
- Designed to be attached to the inside of drawer boxes to accept 3/16", 1/4", 3/8" or 1/2" thick divider material.

Pencil Tray Molding

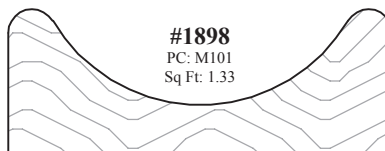

► For PRICING ► See Section N9 in our Wholesale Pricing Catalog.

Moldings

Miscellaneous Molding

Mantel Molding

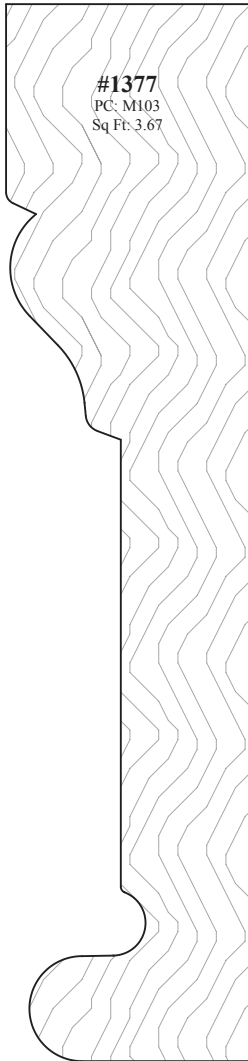

Frieze Molding

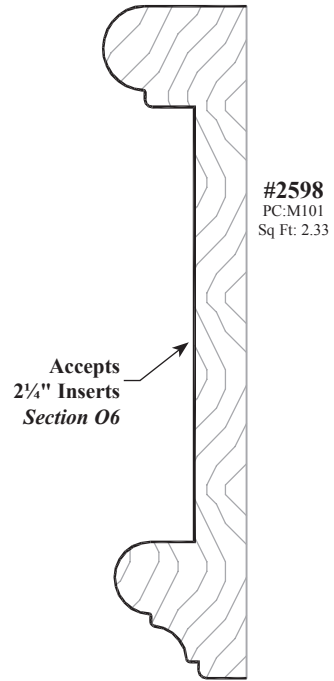
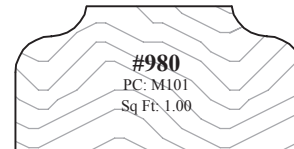
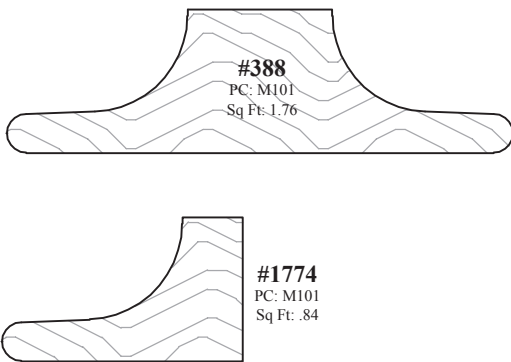

Plate Display Molding



Stemware Molding



Wine Rack Molding

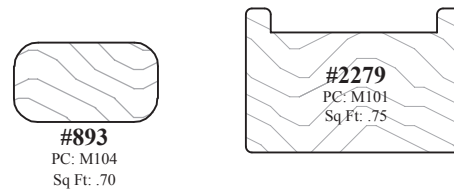

► For PRICING ► See Section N9 in our Wholesale Pricing Catalog.

Bar Rail / Cap Molding

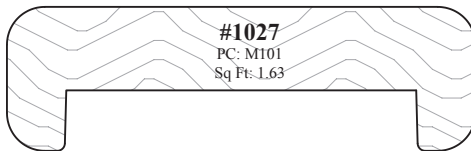
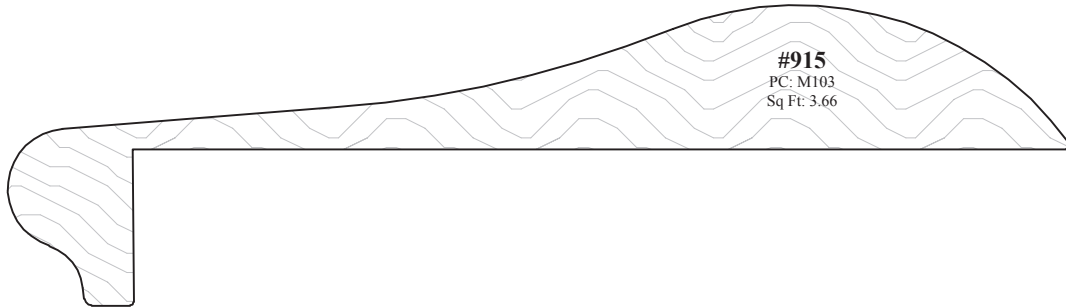
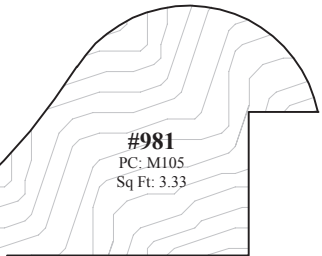
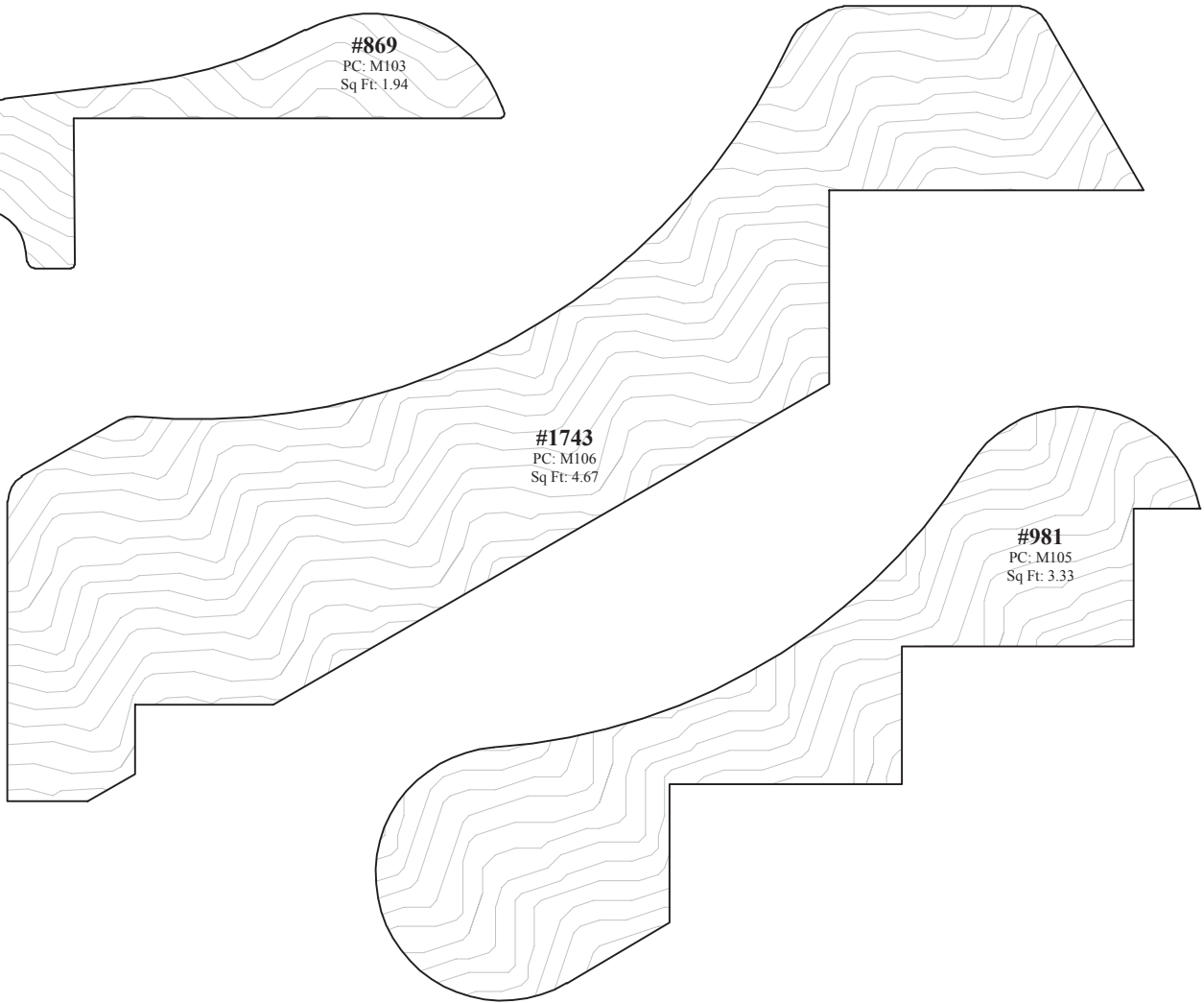
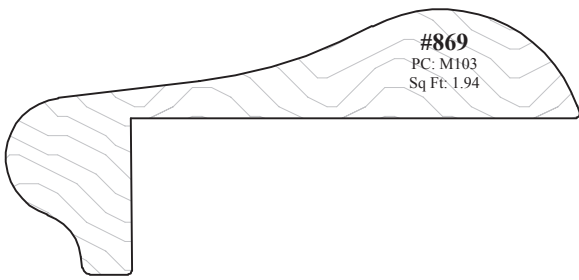

► For PRICING ► See Section N9 in our Wholesale Pricing Catalog.

#1049 Bar Rail Molding (Straight 8' Piece)

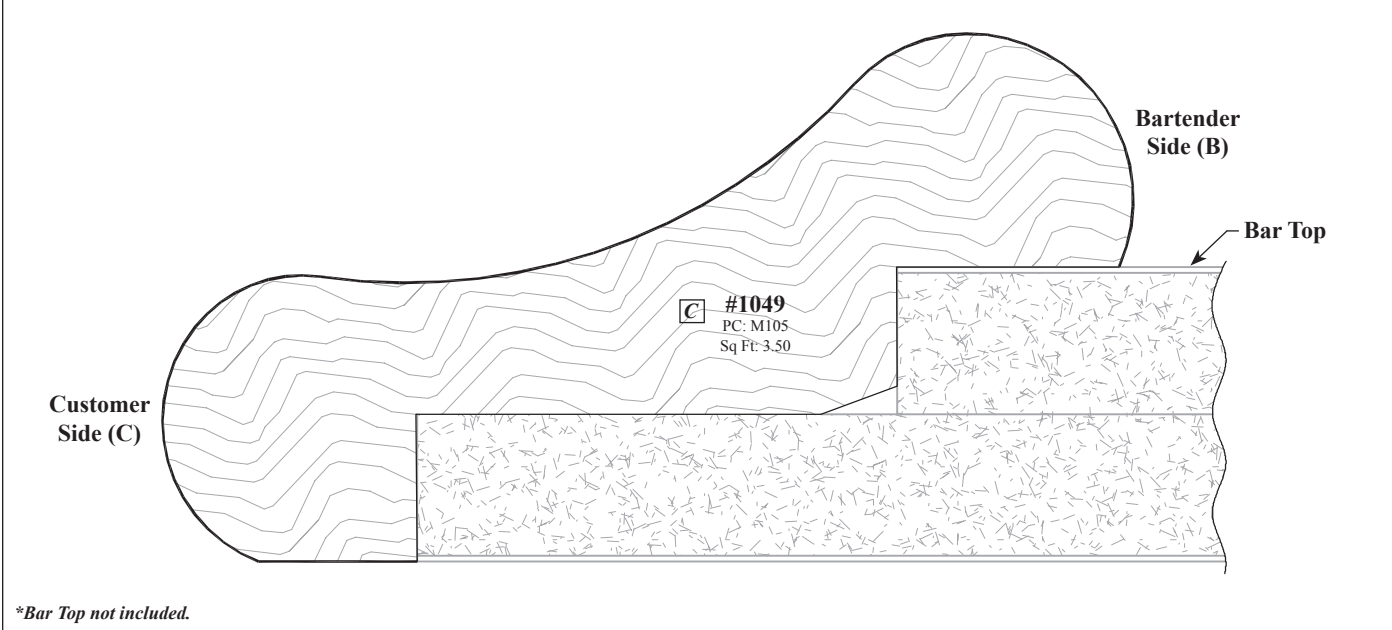

Radius Transition Moldings for #1049 Bar Rail

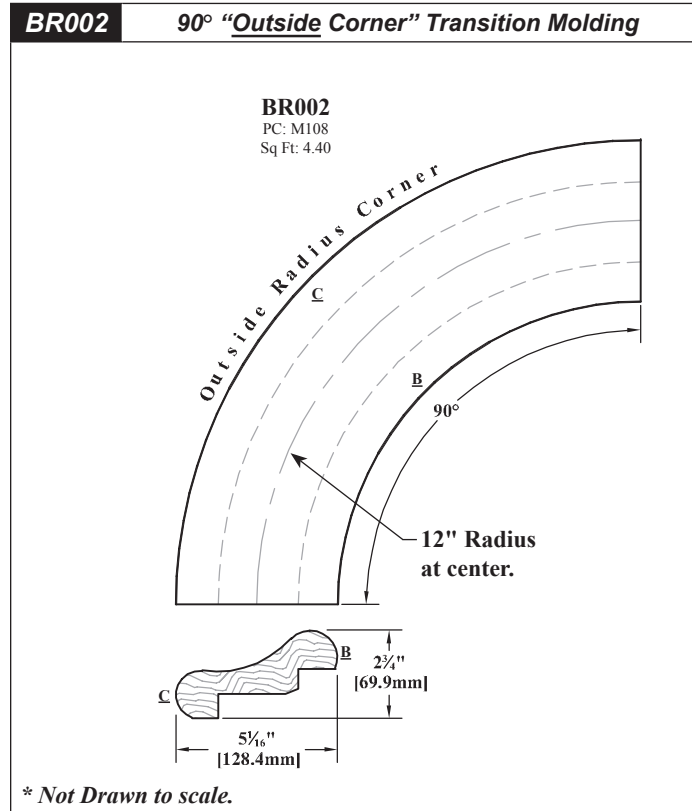
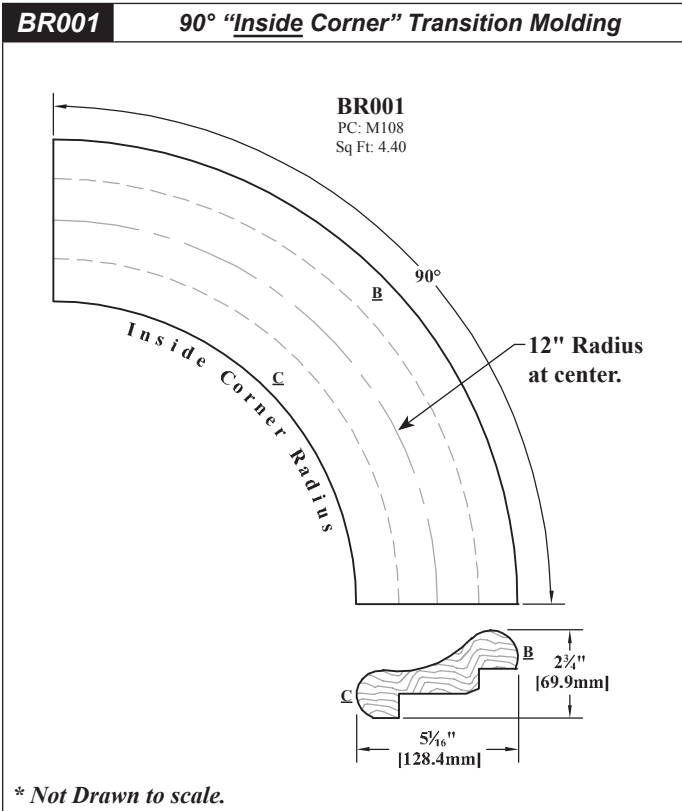

► For PRICING ► See Section N9 in our Wholesale Pricing Catalog.

Radius Transition Moldings for #1049 Bar Rail...continued

BR003 45° "Inside Corner" Transition Molding

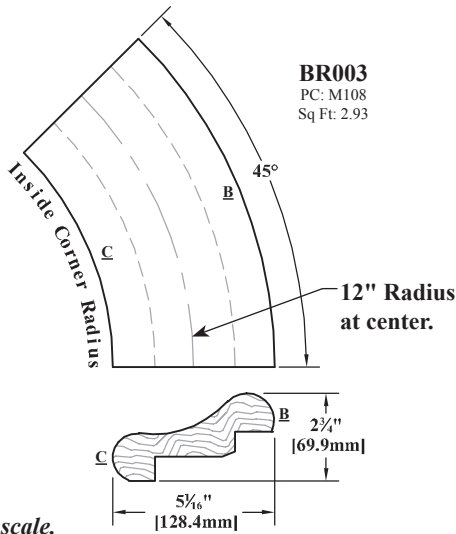

BR004 45° "Outside Corner" Transition Molding

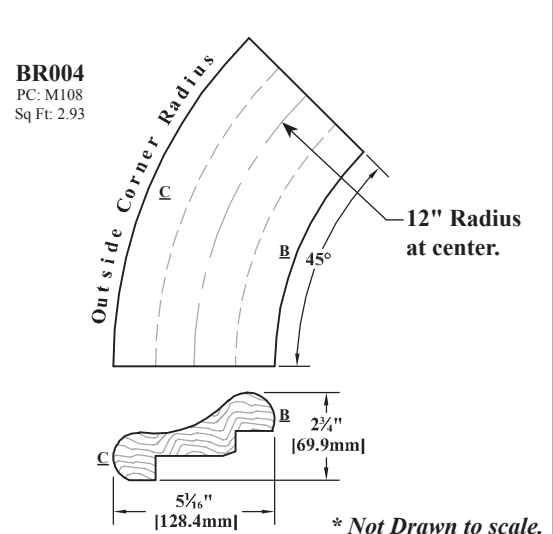

#1049 Bar Rail Molding - Options

BR005 3/8" Thick End Cap

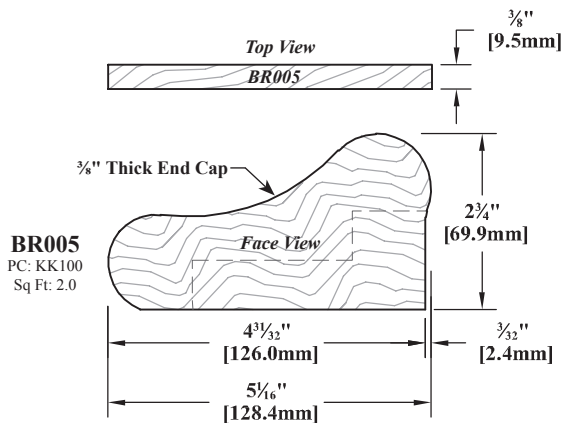

JAM8 Joint Assembly Method - Bolt Lock Rout

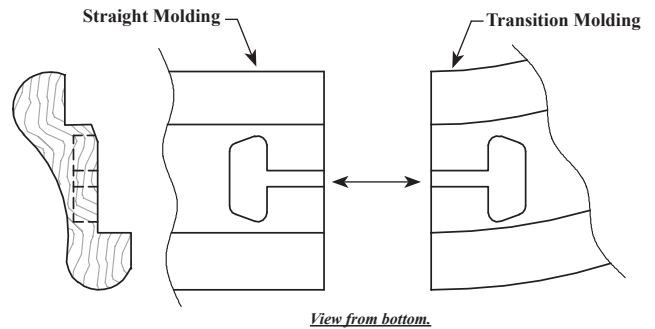

#1049 Bar Rail Molding Notes

1)	Pricing	Please see <i>Section N9</i> of the Wholesale Pricing Catalog.
2)	Wood Species	All standard solid wood species are available.
3)	Finishing	Only available unfinished.
4)	MDF / 3D Laminate	Not available in Raw MDF or 3D Laminate.
5)	Sizes	All part sizes are fixed.
6)	Ordering	When ordering please use <i>Order Form #5 - Moldings & Miscellaneous</i> . Enter quantity, molding / part number and description.
7)	Assembly	Only available unassembled.
8)	End Cap - BR005	End caps are an option that can be used to cap the finished end of a run of #1049 molding. BR005 can be used as a left or right end. Only available shipped loose.
9)	Bolt Lock Route JAM8	Used to connect two pieces of #1049 molding. Bolt Lock Routes are an option that can be added to the end of straight 8' lengths of #1049 and to the Radius Transition Moldings. Bolts included.

► For PRICING ► See Section N9 in our Wholesale Pricing Catalog.

Canopy Styles

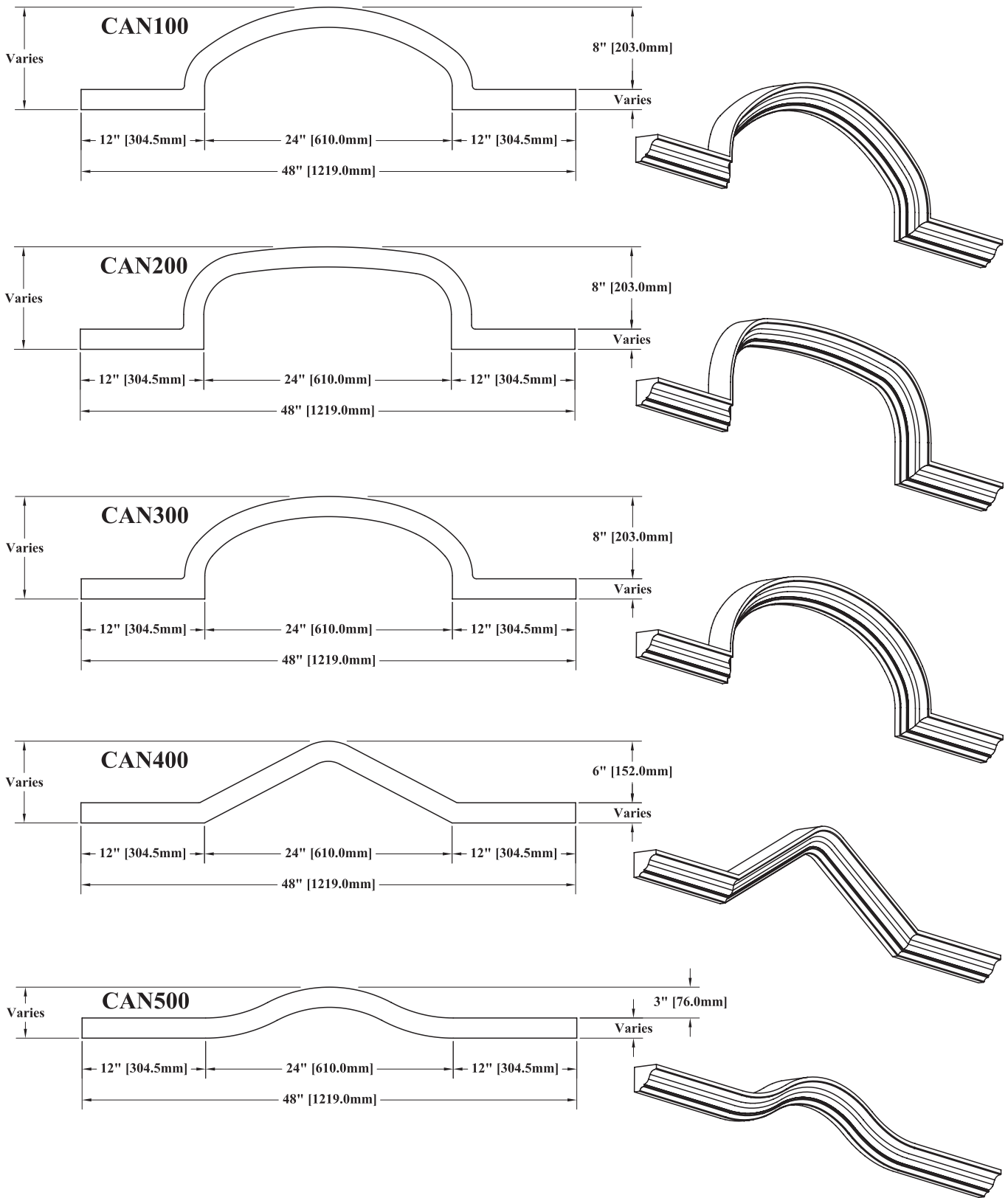

► **For PRICING** ► See Section *N10* in our Wholesale Pricing Catalog.

Canopy Styles

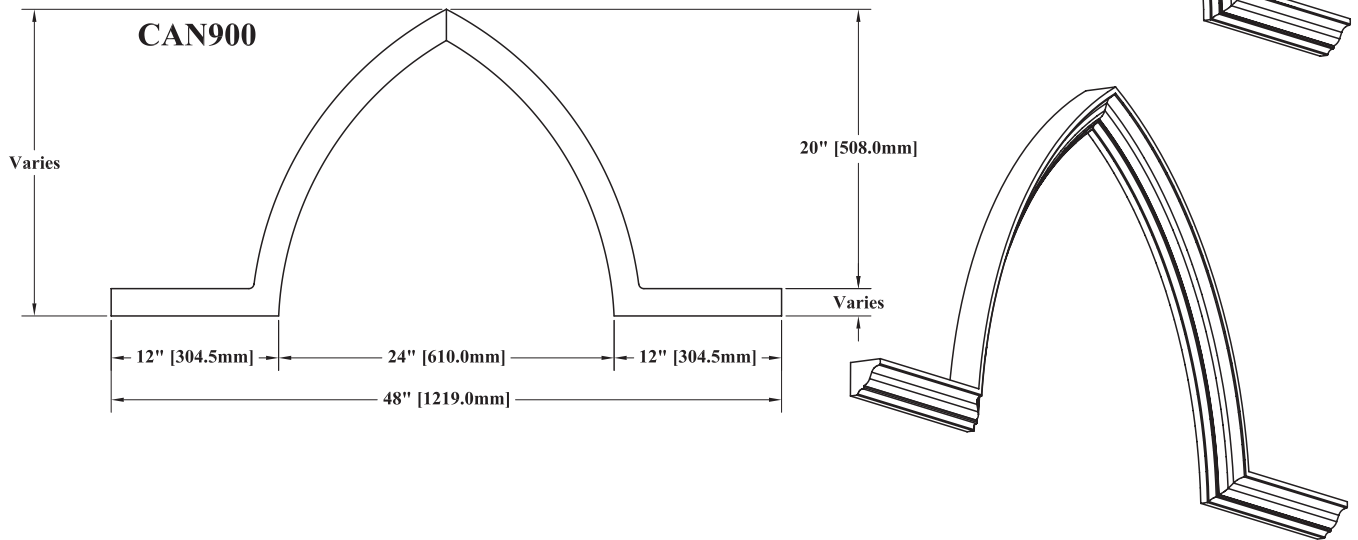
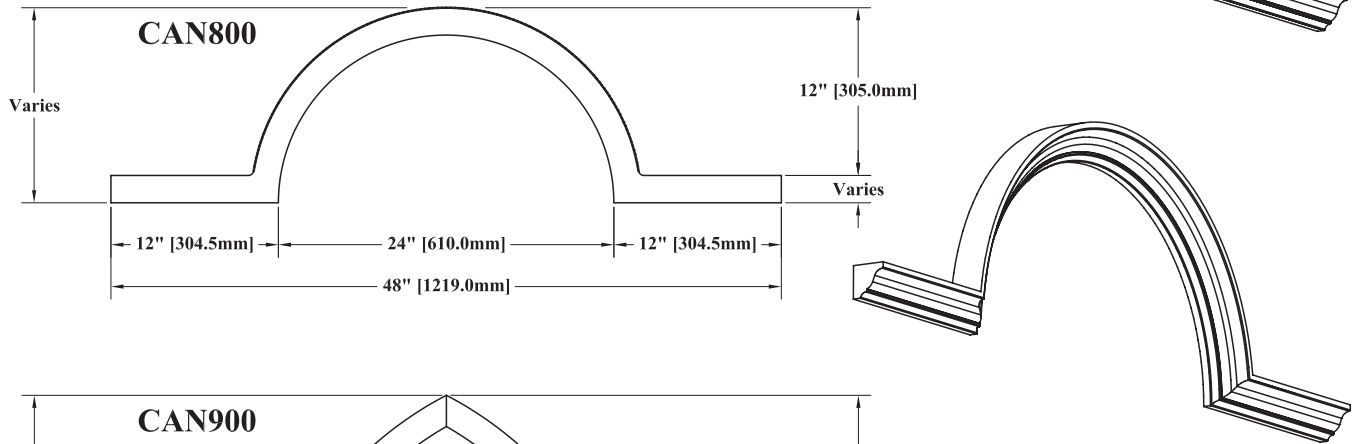
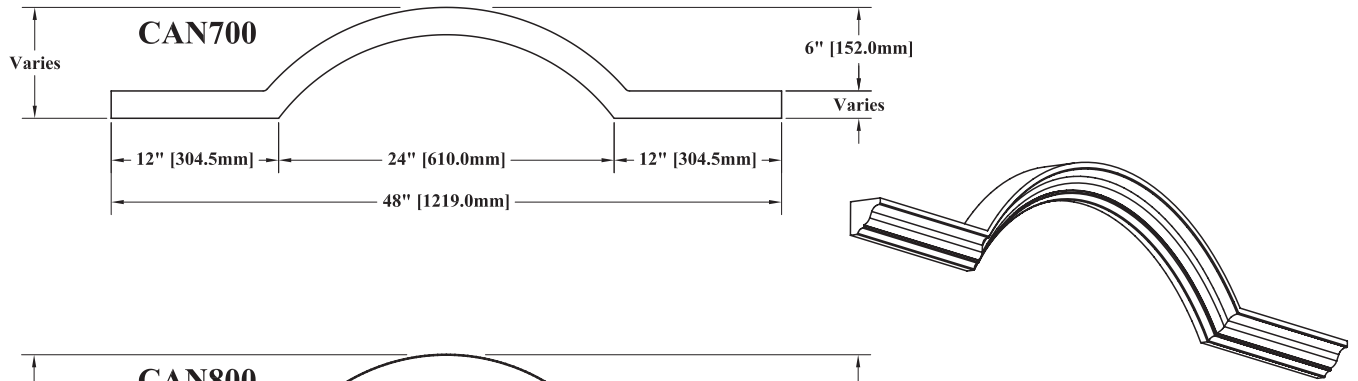
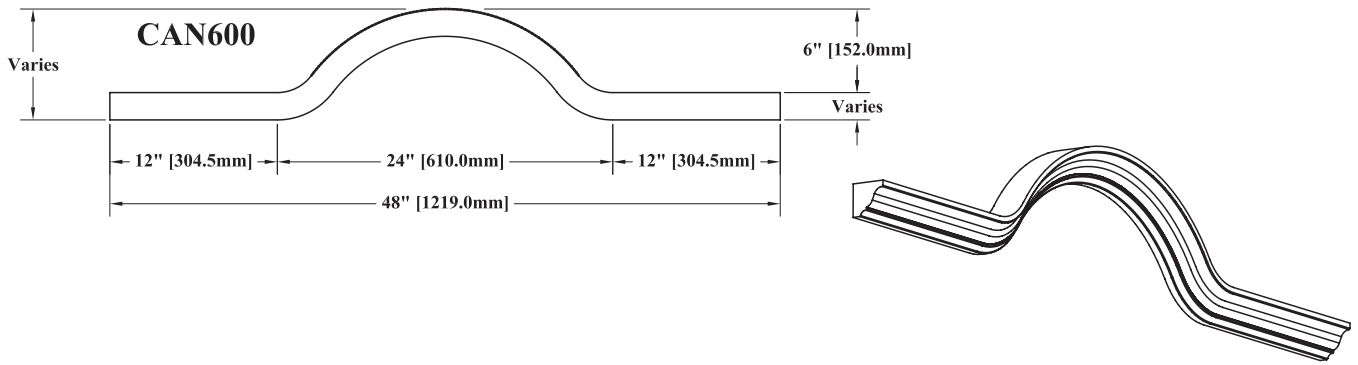

N

► For PRICING ► See Section N10 in our Wholesale Pricing Catalog.

Canopy Molding with Matching Crown Molding

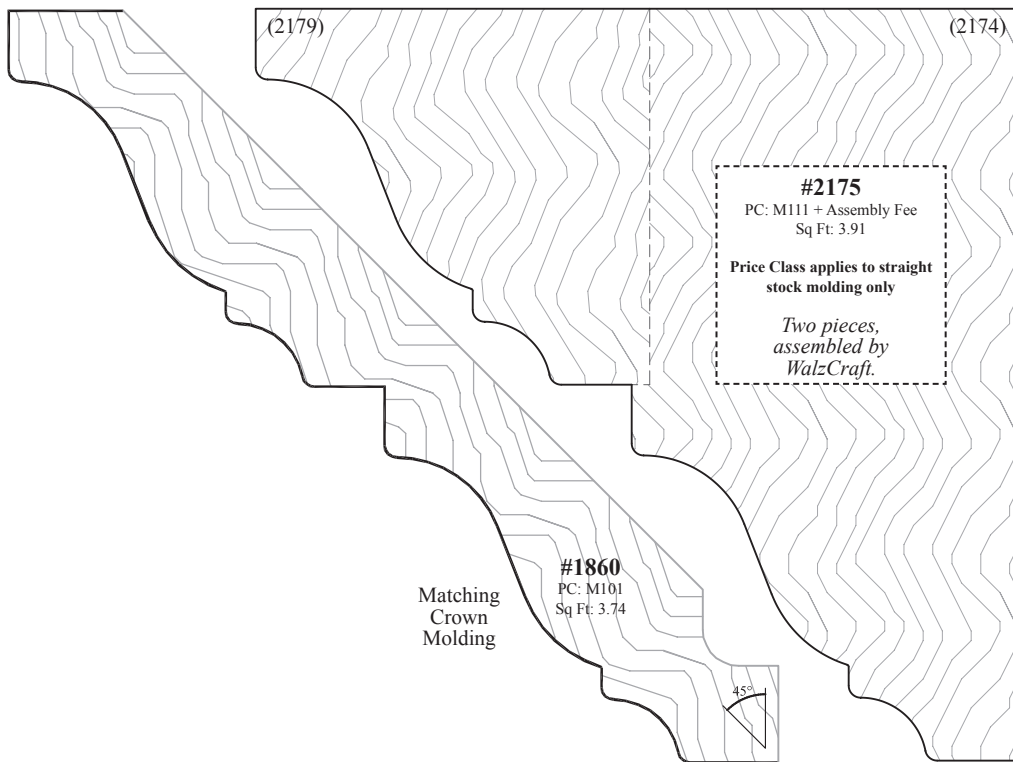
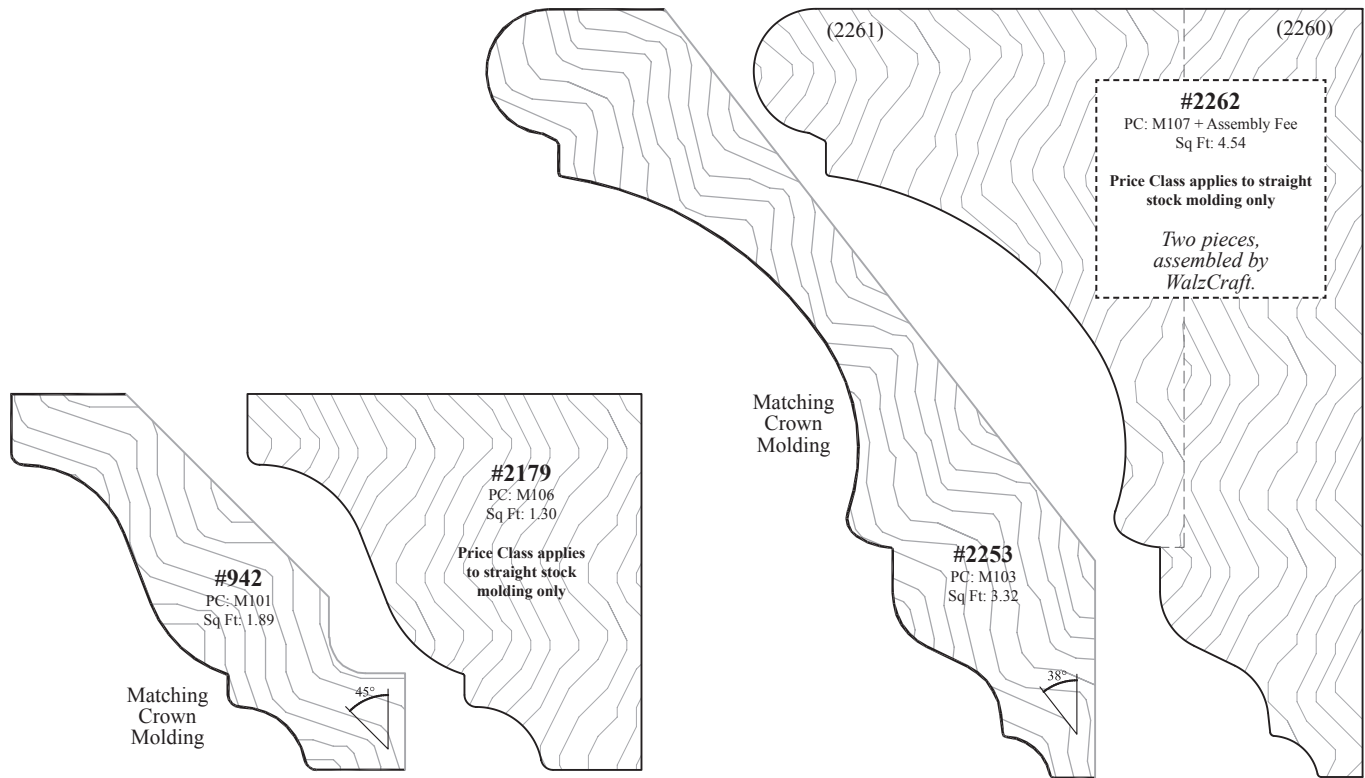

► **For PRICING** ► See Section N10 in our Wholesale Pricing Catalog.

Canopy Molding with Matching Crown Molding

#119
PC: M101
Sq Ft: 1.34
Matching Crown Molding

#2309
PC: M105
Sq Ft: .94
Matching Crown Molding

#1358
PC: M101
Sq Ft: 1.18
Matching Crown Molding

#2310
PC: M103
Sq Ft: .83
Matching Crown Molding

#383
PC: M101
Sq Ft: 1.96
Matching Crown Molding

#2184
PC: M106
Sq Ft: 1.39
Price Class applies to straight stock molding only

#1160
PC: M101
Sq Ft: 2.83
Matching Crown Molding

#2292
PC: M106 + Assembly Fee
Sq Ft: 3.45
Price Class applies to straight stock molding only
Two pieces, assembled by WalzCraft.

#983
PC: M101
Sq Ft: 3.33
Matching Crown Molding

#2182
PC: M115 + Assembly Fee
Sq Ft: 3.48
Price Class applies to straight stock molding only
Two pieces, assembled by WalzCraft.

(2183) (2181) (2293) (2294)

N

► For PRICING ► See Section N10 in our Wholesale Pricing Catalog.

Canopy Styles/Molding Notes

1) Pricing	Please see <i>Section N10</i> of the Wholesale Pricing Catalog .
2) Canopy Styles: Molding Profile Options	Canopy Styles are only available with the following Canopy Molding Profiles: 2175, 2179, 2182, 2184, 2262, 2292, 2309 or 2310 .
	These canopy moldings and their matching crown moldings are also available in straight 8' lengths to use throughout your project. Both 8' straight stock molding profiles are shown.
3) Standard Dimensions	The straight portion on each end of these Canopy Styles is 12" with an overall width of 48".
4) Ordering	1) Select the Canopy Style Number: CAN100, CAN200, CAN300, CAN400, CAN500, CAN600, CAN700, CAN800 or CAN900 .
	2) Select the Canopy Molding Profile: 2175, 2179, 2182, 2184, 2262, 2292, 2309 or 2310 .

Canopy Moldings with Matching Crown Molding

Canopy Molding Number	Matching Crown Molding Number
2175	1860
2179	942
2182	983
2184	383
2262	2253
2292	1160
2309	119
2310	1358

► For PRICING ► See Section N10 in our Wholesale Pricing Catalog.

"Precision" Molded 3/4" Wood Flooring

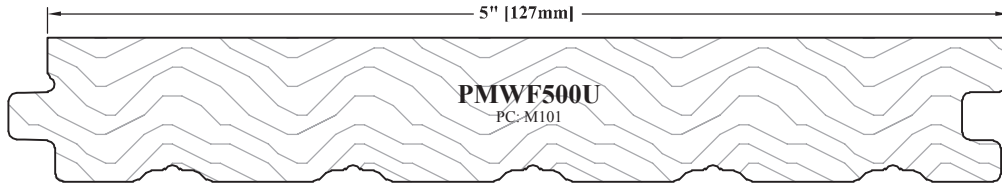
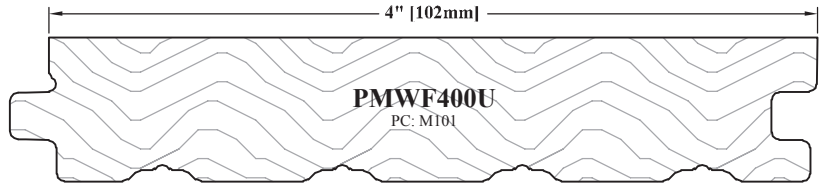
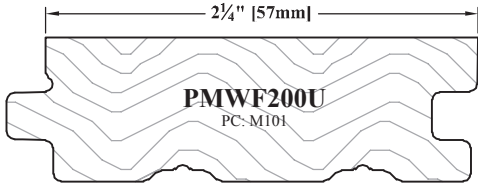
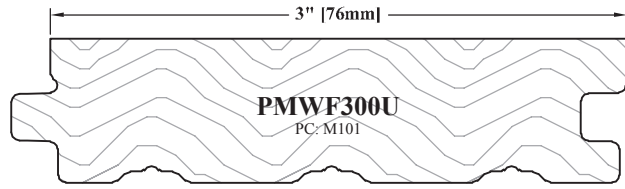
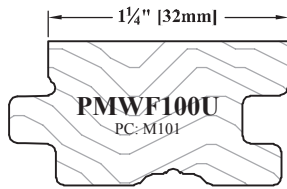

3/4" Wood Flooring Transition Moldings

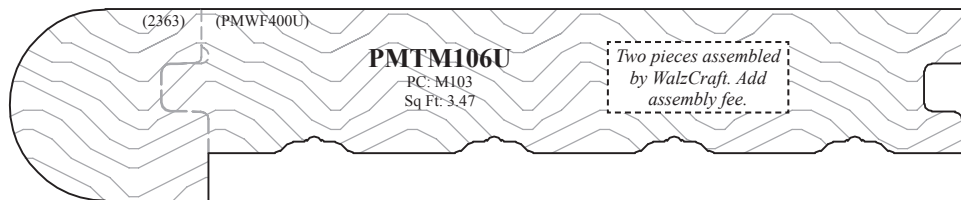
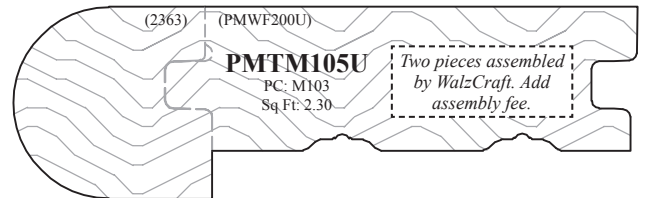
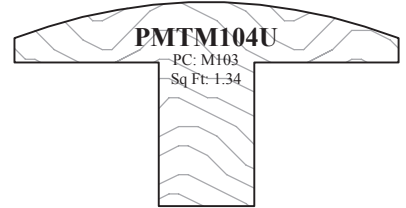
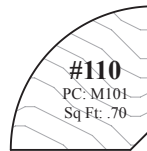
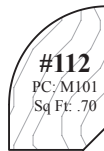

► For PRICING ► See Section N11 in our Wholesale Pricing Catalog.

"Precision" Molded 3/8" Wood Flooring

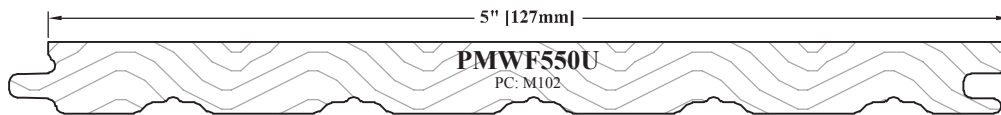
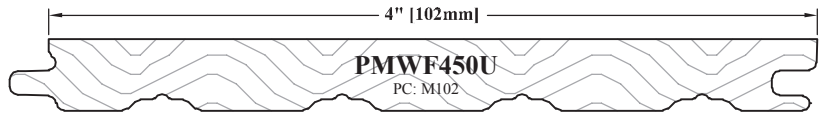
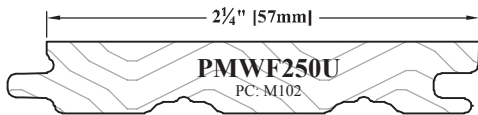
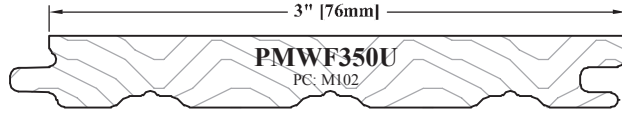
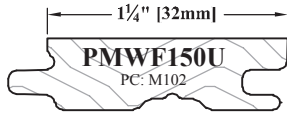

3/8" Wood Flooring Transition Moldings

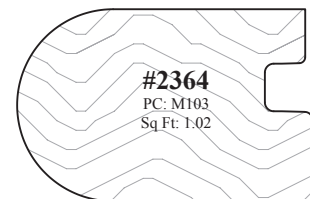
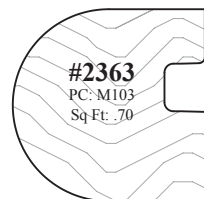
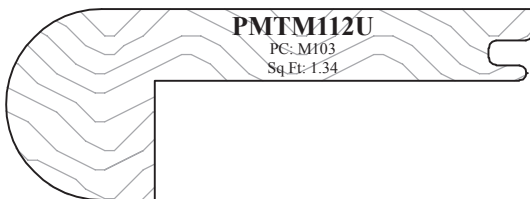
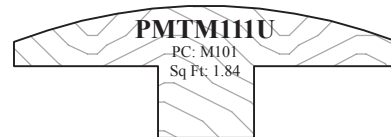
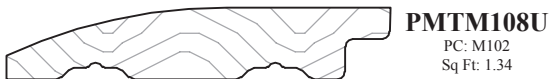
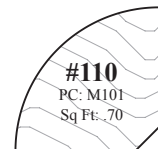
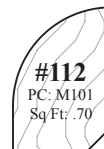
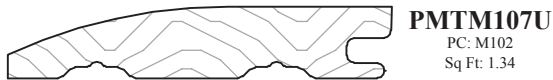

► For PRICING ► See Section N11 in our Wholesale Pricing Catalog.

Precision Molded Wood Flooring Price Classes, # of Sq Ft per Lineal Foot

Molding #	Price Class	Sq Ft / Lineal Foot	Lineal Feet / One Square Foot
PMWF100U	M101	0.121	9.60
PMWF200U	M101	0.205	5.34
PMWF300U	M101	0.268	4.00
PMWF400U	M101	0.350	3.00
PMWF500U	M101	0.434	2.40
PMWF150U	M102	0.121	9.60
PMWF250U	M102	0.205	5.34
PMWF350U	M102	0.268	4.00
PMWF450U	M102	0.350	3.00
PMWF550U	M102	0.434	2.40

N

Wood Flooring Notes

1) Pricing	Please see <i>Section N11</i> of the Wholesale Pricing Catalog .
2) Finishing	Available Unfinished only . (<i>WalzCraft's cabinet grade finish is not engineered for wood flooring.</i>)
3) Sanding	Precision Molded Wood Flooring requires minimal sanding after installation.
4) Material	Moldings are drawn to actual size and are sold in random lengths, varying between 36" and 96".
	Moldings will also be end milled.
	Sanded to 180 grit.
5) Ordering	Total square footage must be supplied. (<i>Note, your total square footage should accommodate a waste factor.</i>)
6) Transition Moldings	Sold in 8' lengths, with 93" guaranteed to be usable.
	Moldings over 6" in width may be produced from a glued up panel, due to lumber availability.

► For PRICING ► See Section N11 in our Wholesale Pricing Catalog.

Molding "Shorts Program"

When working with solid wood occasionally defects are exposed through the manufacturing process that will not allow us to sell the molding as a clear 8' Select/Premium or Natural/Standard Grade. We are sometimes left with 3' - 7' of usable material. Part of our mission is to use our materials and resources in the most efficient manner, which is why we offer the availability of 3' - 7' moldings through this program. As an incentive, when using this **Molding "Shorts Program"** there will be a discount offered if 3' - 7' moldings are available. Please see *Section N12* of the **Wholesale Pricing Catalog** for more information. *The Molding "Shorts Program" does not apply to Outsourced Moldings.*

Molding Notes

1) Pricing	Please see <i>Section N12</i> of the Wholesale Pricing Catalog .		
2) Sanding	Moldings are sanded to 180 grit.		
3) Finishing	Finishing is an option.		
4) Molding Drawings	Solid wood moldings are drawn to actual size and sold in 8' lengths. 93" is guaranteed to be usable.		
5) Usable Molding Lengths	Usable Length of 8' & longer Moldings <i>(Excludes Random Length)</i> WalzCraft offers standard 8' long moldings, and upon request and availability, also manufactures longer moldings from 9' to 16' in even foot increments. In all cases, WalzCraft will ship a molding that is at a minimum 97% usable, rounded down to the nearest inch, per the table to the right. Please consider the lengths listed in the column <i>"Expect as Minimum Usable Material"</i> as a guide for which even foot increment molding to purchase.	Size Ordered	Expected Minimum Usable Material
		8'	93"
		9'	104"
		10'	116"
		11'	128"
		12'	139"
		13'	151"
		14'	162"
		15'	174"
		16'	186"
6) Usable "Random Lengths"	<i>Random Length material is 90% usable.</i>		
7) Molding Widths Over 6"	Due to lumber availability, moldings over 6" wide may be produced from glued up panels.		
8) 3' - 8' "Random Length" Molding Program	Minimum quantity of 200 lineal feet. Use Moldings "Shorts Program" if under minimum quantity. Please specify total footage when ordering.		
9) 3' - 12' "Random Length" Molding Program	Minimum quantity of 200 lineal feet. Use Moldings "Shorts Program" if under minimum quantity.		
	Random lengths that range from 3' to 12' must be either Picked Up or shipped via Common Carrier.		
	Lengths greater than 8' are subject to availability. <i>Please note that the choice of Wood Species and Grade can impact the availability of lengths greater than 8'.</i>		
10) 8' - 12' Length Moldings	For those occasions when you need a molding longer than 8', we will do our best to produce those lengths up to 12' long.		
	Please bear in mind, that longer length moldings are not always possible to produce in all wood species and grades.		
	<i>Please see Usable Molding Lengths, note # 5) above.</i>		
11) Molding Lengths Longer than 12'	Please contact our Customer Support Team, and ask that they research material availability and Wait Times / Lead Times.		
	Please bear in mind, that longer length moldings are not always possible to produce in all wood species and grades.		
	<i>Please see Usable Molding Lengths, note # 5) above.</i>		

► For PRICING ► See Section N12 in our Wholesale Pricing Catalog.

Molding Notes...continued

12)	“Cut to Length” Stemware Moldings	Stemware Moldings #388 & #1774 are available “Cut to Length”
		If WalzCraft is finishing the moldings, the ends will also be finished.
13)	3D Laminate (RTF)	★ = Available on products using RTF.
		3D Laminate (RTF) moldings use the same foil colors that are used on the doors, so the color match is exact.
		For quality reasons, 3D Laminate (RTF) moldings have a solid wood core (Paint Grade Maple).
		Only the face of the molding is covered with 3D Laminate (RTF) foil. The back is unfinished wood.
14)	Curved Products	The ☐ indicates profiles that are available when ordering Convex/Concave Products.
15)	Column Wraps	Column Wraps can be used as transition moldings between cabinets of different depths.
16)	Column Wrap Radius	The radius for a Column Wrap Molding is measured from the center of the thickness.
17)	Fastener Relief Cut	FRC = Fastener relief cut. See <i>page N1-3</i> for assembly detail. Hole drilling and wood screw by customer. FRC is not applicable with Convex/Concave or Canopy moldings.

N

► **For PRICING** ► See Section N12 in our Wholesale Pricing Catalog.



Bead and Egg & Dart Molding - Carved, Embossed and Plain

* When ordering this molding, please specify the total lineal footage required.

Carved Beaded Molding



#1714



Due to tear out in the manufacturing process, this molding is only available in Maple.

* When ordering this molding, please specify the total lineal footage required.

Carved Beaded Molding



#1107



Due to tear out in the manufacturing process, this molding is only available in Maple.

* When ordering this molding, please specify the total lineal footage required.

Embossed Beaded Molding



#1356

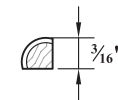

* When ordering this molding, please specify the total lineal footage required.

Embossed Beaded Molding

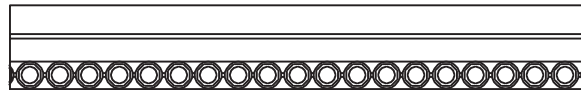

#2381



* When ordering this molding, please specify the total lineal footage required.

Embossed Egg & Dart Molding



#1108



Embossed Egg & Dart Molding

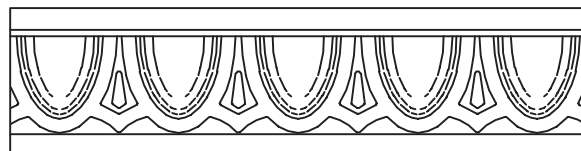

#1163



Plain Egg & Dart Molding

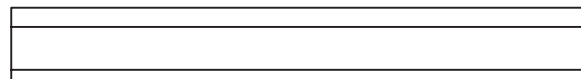

#1999

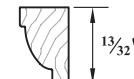

This molding is similar to molding #1108 without the embossed Egg & Dart pattern.

► For PRICING ► See Section N13 in our Wholesale Pricing Catalog.

Quarter and Half Round Rope Molding Options (Face and End Views)

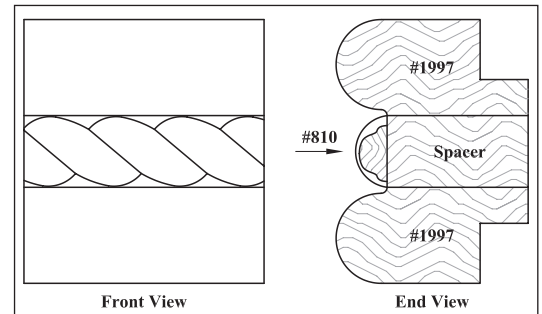
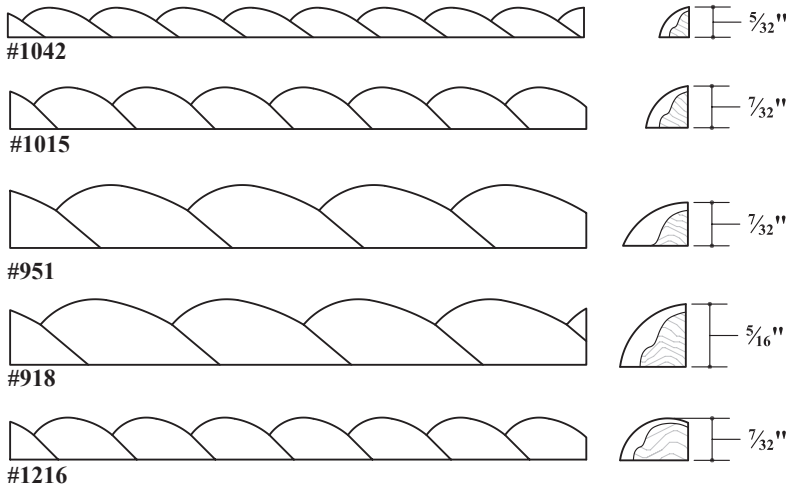

Moldings can be combined in different ways to create your own unique look.

These two drawings are ½ of the actual size.

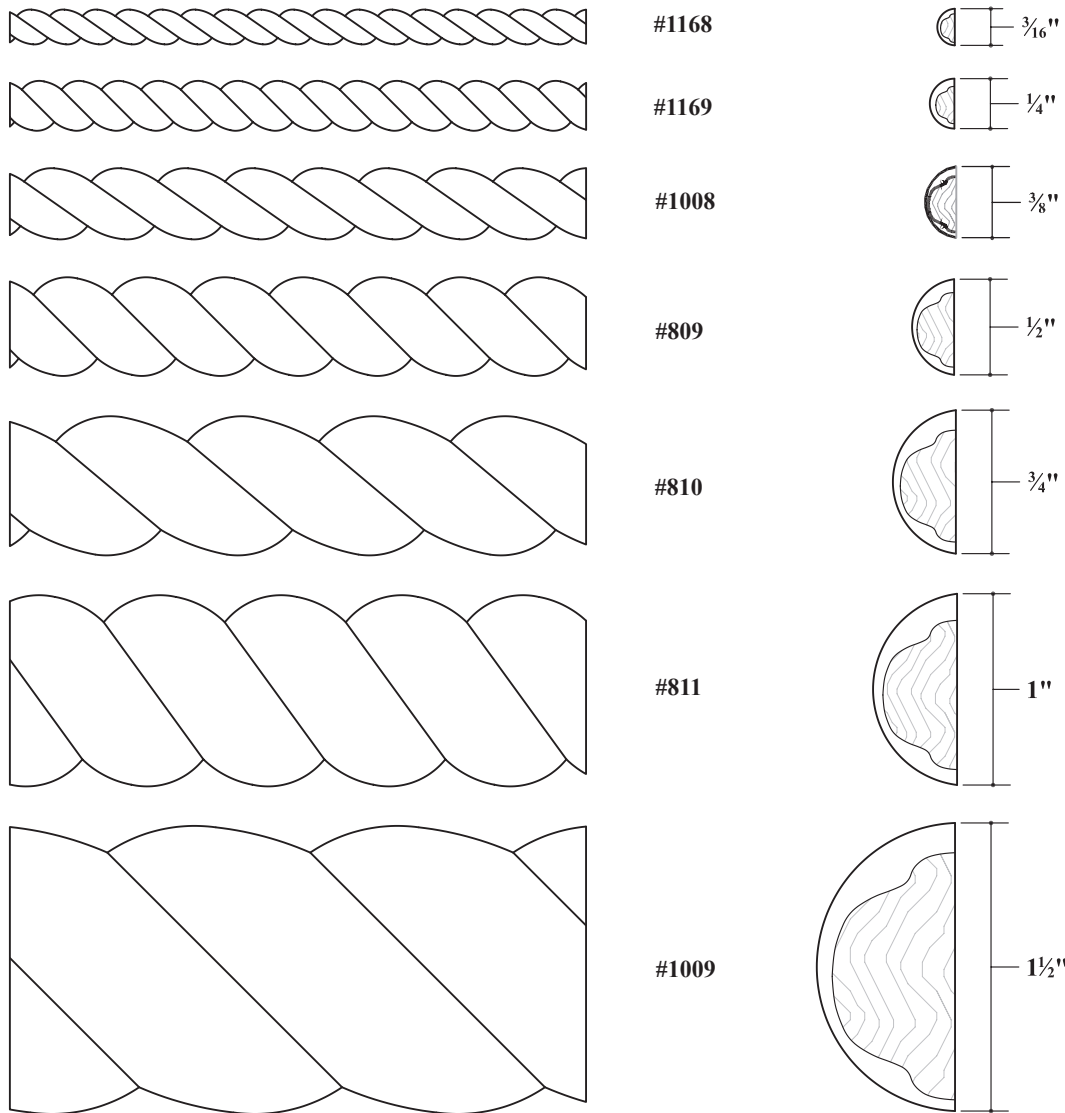

► **For PRICING** ► See Section N13 in our Wholesale Pricing Catalog.

Outsourced Molding Notes

1)	Pricing	Please see <i>Section N13</i> of the Wholesale Pricing Catalog .
2)	Finishing	Finishing is an option. See <i>Chapter R</i> .
3)	Applied Moldings	These moldings may also be applied to some Traditional & Mitered stile and rail profiles with a shelf. See <i>Chapter E</i> .

► **For PRICING** ► See *Section N13* in our Wholesale Pricing Catalog.