



Functional
Flexibility
&
Design
Flexibility



← Stile & Rail →
Width Flexibility

Applied →
Moldings

Mirrored →
Joints

& much more!



Chapter E Table of Contents

Section #	Section Name/Contents	Page #
E.1	Stile & Rail - Traditional Mortise & Tenon Joinery	E.1.2
	◦ Stile & Rail - Traditional M/T Joinery - Only Available with Applied Molding (SR133 & SR155)	E.1.11
E.2	Stile & Rail - Traditional Mortise & Tenon Joinery - Mirror Joints	E.2.1
E.3	Stile & Rail - Traditional Mortise & Tenon Joinery - Old World	E.3.1
E.4	Stile & Rail - Inside Edge Applied Molding	E.4.1
	◦ Stile & Rail - Inside Edge Applied Molding - Old World	E.4.12
E.5	Stile & Rail - Shelf Applied Molding	E.5.1
	◦ Stile & Rail - Shelf Applied Molding - Quarter Round Rope Molding	E.5.12
	◦ Stile & Rail - Shelf Applied Molding - Old World	E.5.19
E.6	Stile & Rail - Face Applied Molding	E.6.1
	◦ Stile & Rail - Face Applied Molding - Half Round Rope Molding	E.6.7
	◦ Stile & Rail - Face Applied Molding - Built-In Shelf/Miter Profiles	E.6.8
	◦ Stile & Rail - Face Applied Molding - RAM Rout/Miter Profiles	E.6.9
E.7	Applied Molding - Corner Blocks	E.7.1
E.8	Applied Molding - Outsourced Moldings	E.8.1
E.9	Stile & Rail - Mitered (<i>Mitre</i>) - MP600/MP6000 Series	E.9.1
	◦ Molder Edges (ME) - Outside Edge Options	E.9.65
E.10	Stile & Rail - Mitered (<i>Mitre</i>) - MP700 Series	E.10.1
E.11	Stile & Rail - Mitered (<i>Mitre</i>) - MP900 Series - Old World	E.11.1
E.12	Center Panel - Standard Raised/Recessed Raised Panels	E.12.1
E.13	Center Panel - Reversed Solid Center Panel (RVSCP-PR324)	E.13.1
E.14	Center Panel - Old World Raised	E.14.1
E.15	Outside Edge - Standard	E.15.1
E.16	Outside Edge - Applied Molding	E.16.1

**Outside Edge – Molder Edges (ME) for MP600/MP6000 Series...See Section E.9 **

**Outside Edges for 1-Piece MDF/3D Laminate (RTF)...See Section V.1 **

Profile Options

Stile & Rail - "Traditional" Mortise & Tenon Joinery

3/4" [19.3mm] Thick "Traditional" Door and Frame Construction

Raised & Flat Panel Stile & Rail Profile

Frame GRF Profile

Standard Lite Mullion

True Lite Mullion

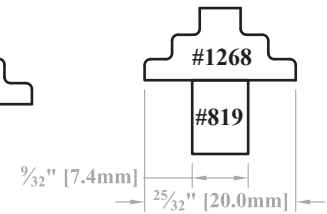
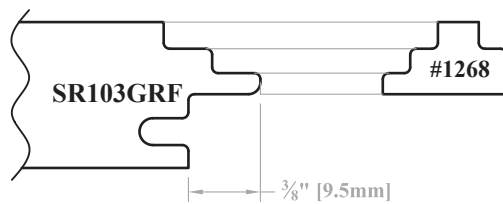
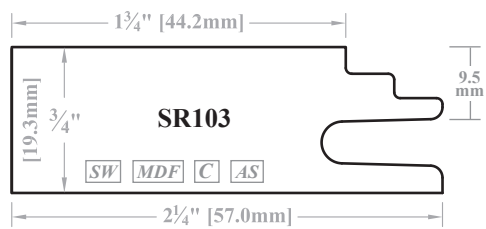
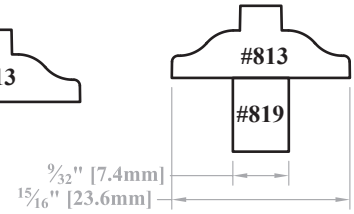
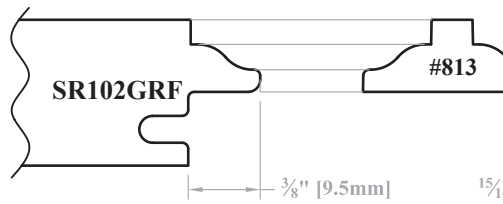
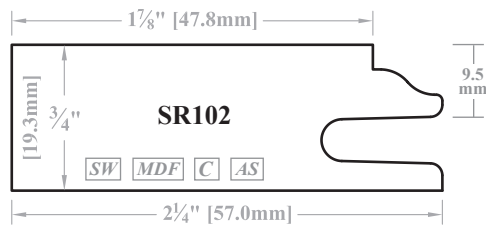
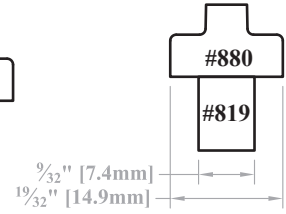
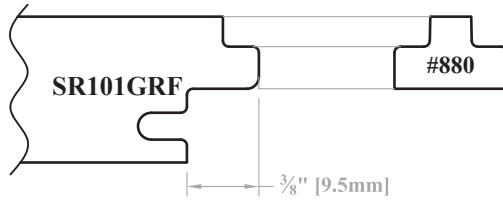
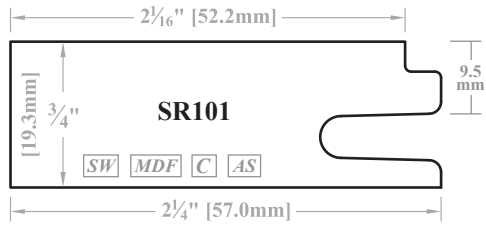
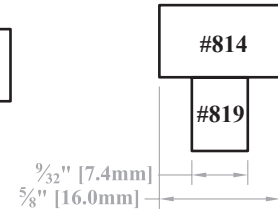
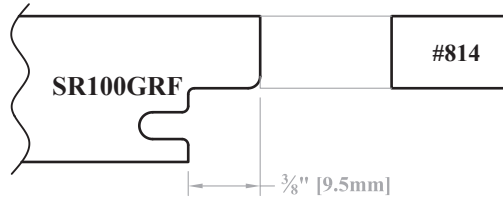
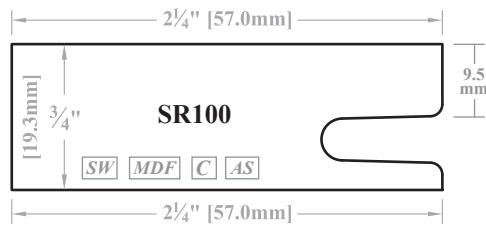

See Profile Options notes in Section B.12 for alternative mullion.

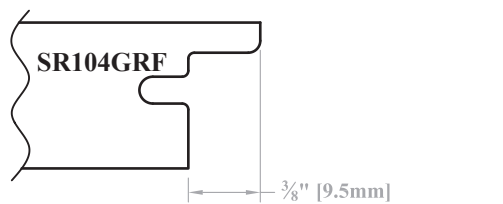
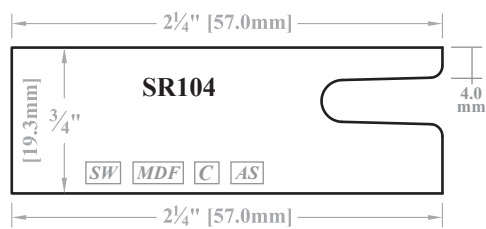

Matching mullion stock is not available for this profile.

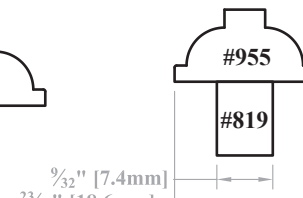
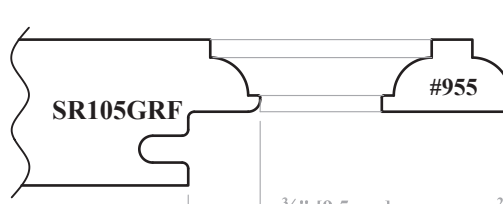
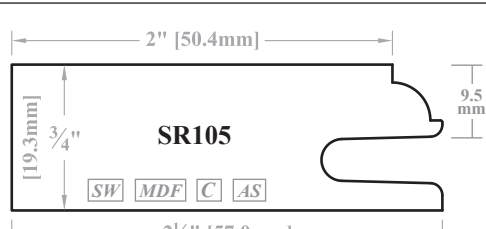

SW = Available in Solid Wood. MDF = Available in Medium Density Fiberboard (MDF). C = Available for Convex/Concave products. AS = Available on Adventure Series Doors.

► For PRICING ► See Section E.1 in our current Wholesale Pricing Catalog.



3/4" [19.3mm] Thick "Traditional" Door and Frame Construction

Raised & Flat Panel Stile & Rail Profile Frame GRF Profile Standard Lite Mullion True Lite Mullion

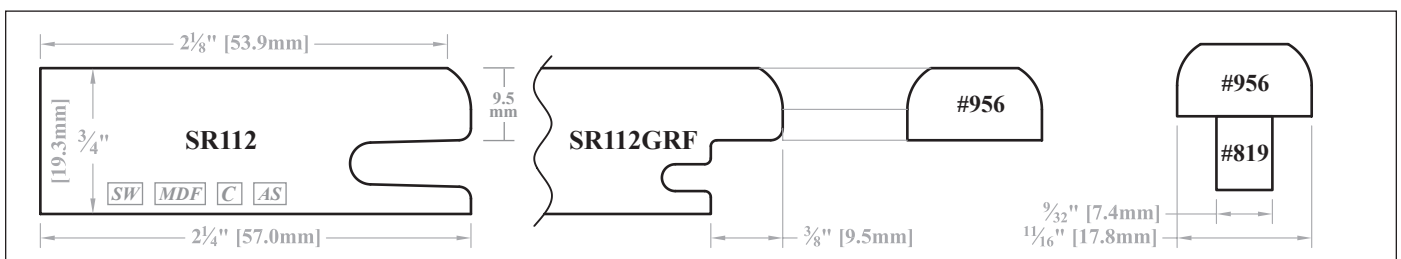
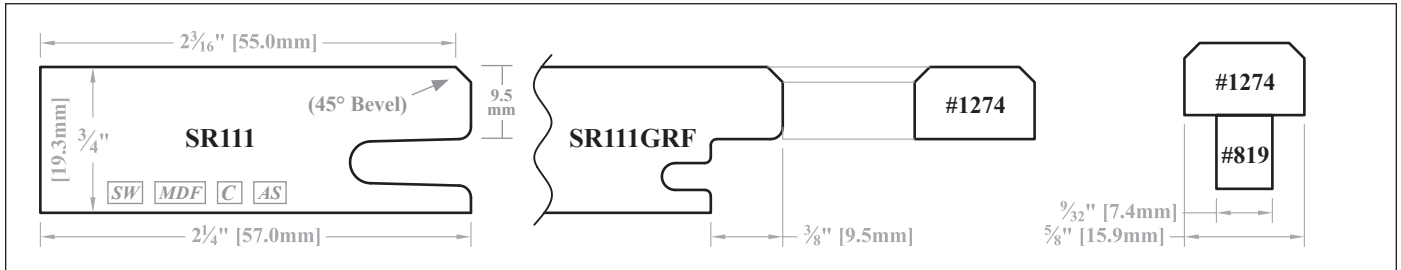
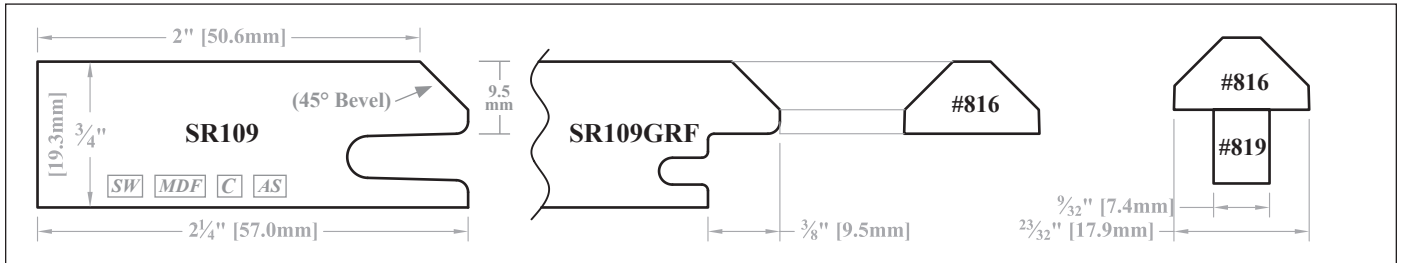
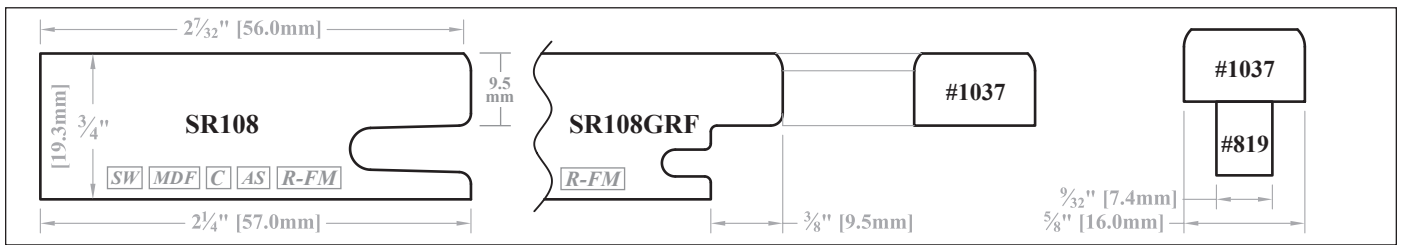
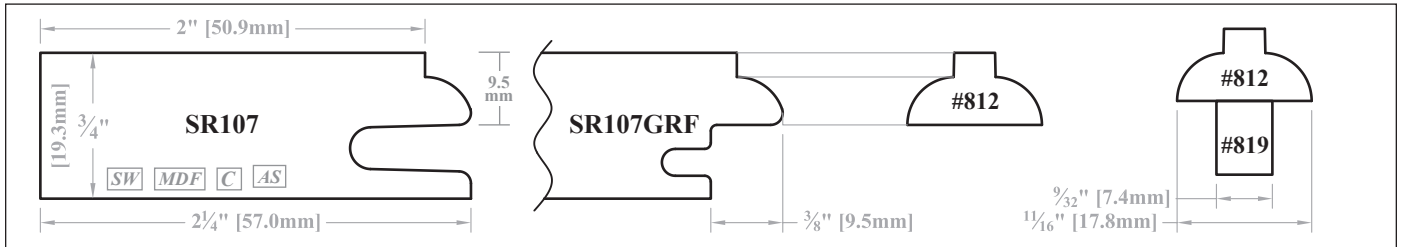
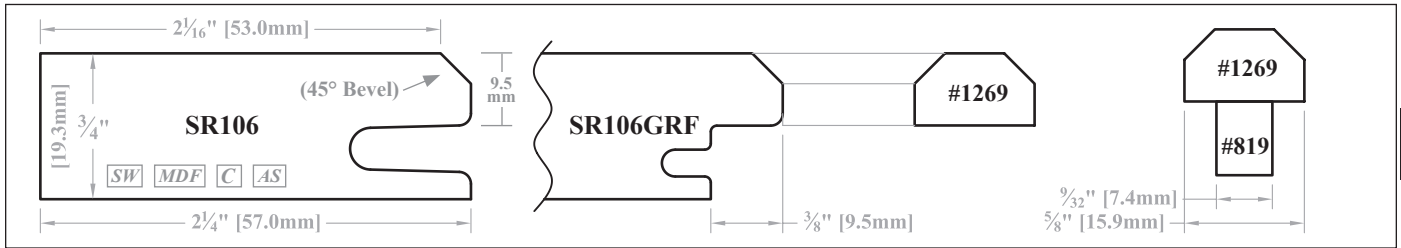

SW = Available in Solid Wood. MDF = Available in Medium Density Fiberboard (MDF). C = Available for Convex/Concave products. R-FM = French Miter Recommended.

► For PRICING ► See Section E.1 in our current Wholesale Pricing Catalog.

Profile Options

Stile & Rail - "Traditional" Mortise & Tenon Joinery

$\frac{3}{4}$ " [19.3mm] Thick "Traditional" Door and Frame Construction

Raised & Flat Panel Stile & Rail Profile

Frame GRF Profile

Standard Lite Mullion

True Lite Mullion

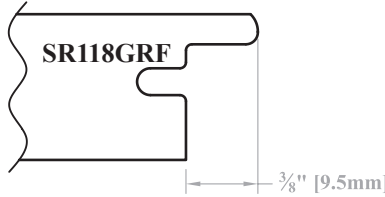
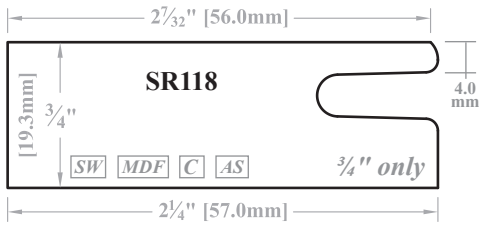
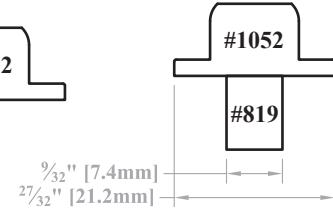
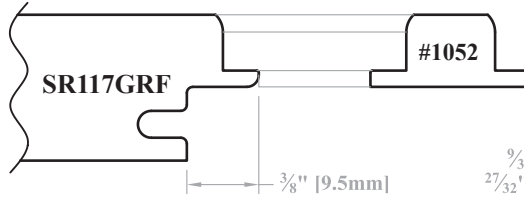
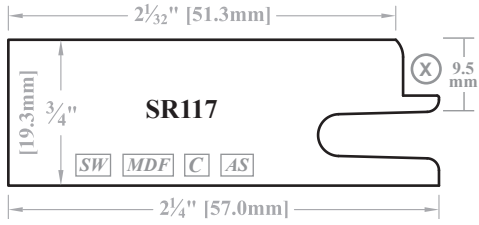

Matching mullion stock is not available for this profile.

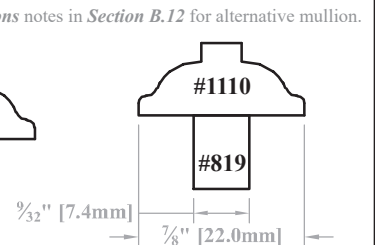
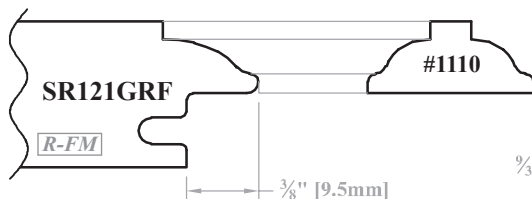
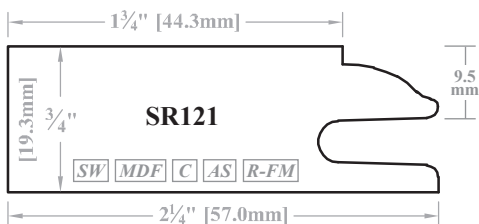
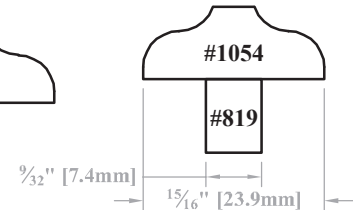
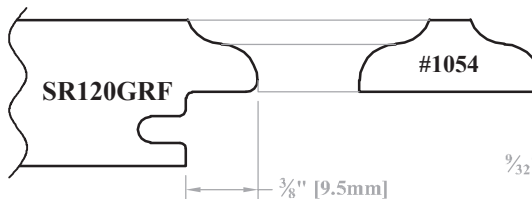
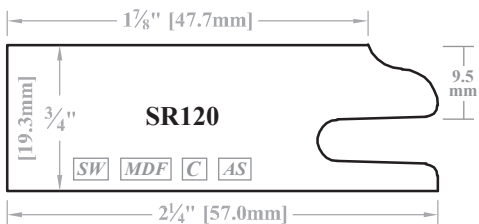
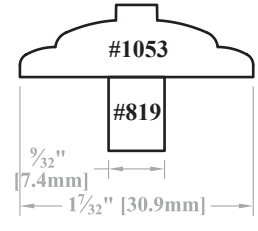
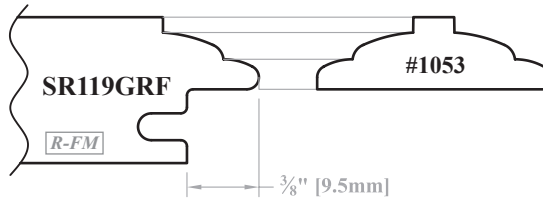
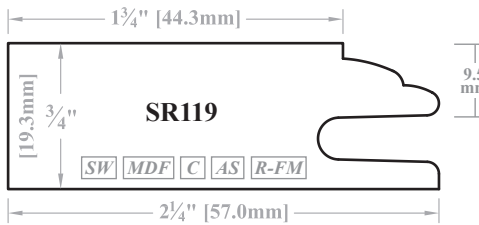



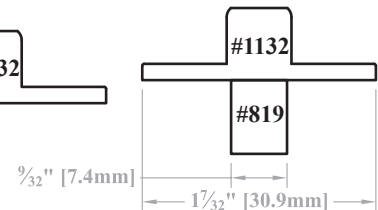
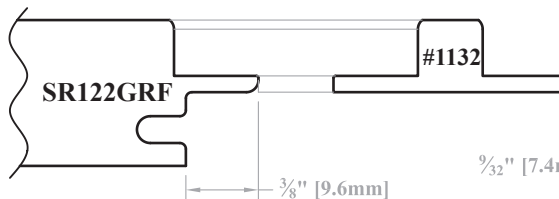
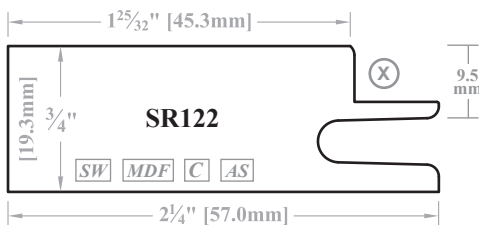







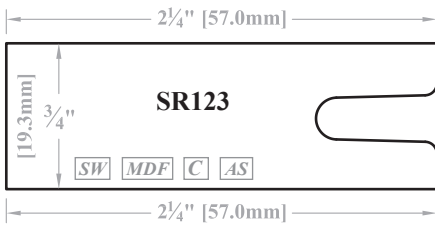
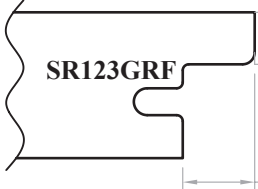

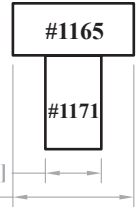
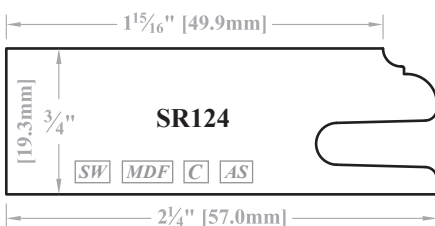
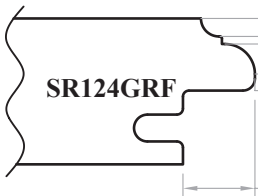

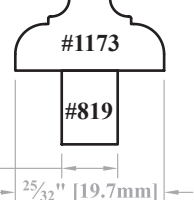
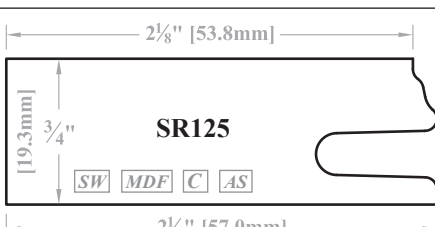
See Profile Options notes in Section B.12 for alternative mullion.

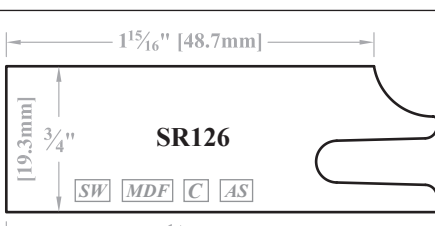

SW = Available in Solid Wood. MDF = Available in Medium Density Fiberboard (MDF). X = Applied Molding Shelf, molding is optional. R-FM = French Miter Recommended.

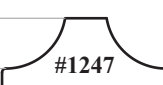
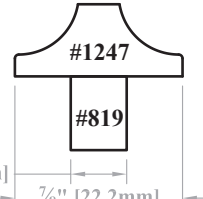
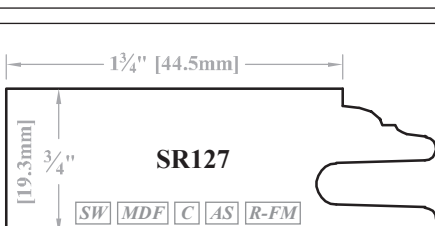
► For PRICING ► See Section E.1 in our current Wholesale Pricing Catalog.

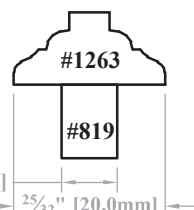
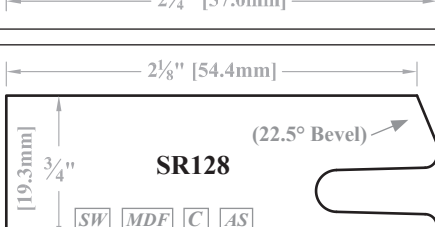
3/4" [19.3mm] Thick "Traditional" Door and Frame Construction

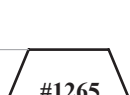
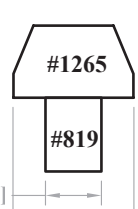
Raised & Flat Panel Stile & Rail Profile	Frame GRF Profile	Standard Lite Mullion	True Lite Mullion
 <p>SR123 [SW] [MDF] [C] [AS] 2 1/4" [57.0mm] 19.3mm [19.3mm] 3/4"</p>	 <p>SR123GRF 3/8" [9.5mm]</p>	 <p>#1165</p>	 <p>#1165 #1171 3/32" [7.4mm] 5/8" [16.0mm]</p>
 <p>SR124 [SW] [MDF] [C] [AS] 2 1/4" [57.0mm] 19.3mm [19.3mm] 3/4"</p>	 <p>SR124GRF 3/8" [9.5mm]</p>	 <p>#1173</p>	 <p>#1173 #819 3/32" [7.4mm] 25/32" [19.7mm]</p>
 <p>SR125 [SW] [MDF] [C] [AS] 2 1/4" [57.0mm] 19.3mm [19.3mm] 3/4"</p>	 <p>SR125GRF 3/8" [9.5mm]</p>	 <p>#1211</p>	 <p>#1211 #819 3/32" [7.4mm] 9/16" [14.3mm]</p>
 <p>SR126 [SW] [MDF] [C] [AS] 2 1/4" [57.0mm] 19.3mm [19.3mm] 3/4"</p>	 <p>SR126GRF 3/8" [9.5mm]</p>	 <p>#1247</p>	 <p>#1247 #819 3/32" [7.4mm] 7/8" [22.2mm]</p>
 <p>SR127 [SW] [MDF] [C] [AS] [R-FM] 2 1/4" [57.0mm] 19.3mm [19.3mm] 3/4"</p>	 <p>SR127GRF [R-FM] 3/8" [9.5mm]</p>	 <p>#1263</p>	 <p>#1263 #819 3/32" [7.4mm] 25/32" [20.0mm]</p>
 <p>SR128 [SW] [MDF] [C] [AS] 2 1/4" [57.0mm] 19.3mm [19.3mm] 3/4" (22.5° Bevel)</p>	 <p>SR128GRF 3/8" [9.5mm]</p>	 <p>#1265</p>	 <p>#1265 #819 3/32" [7.4mm] 5/8" [16.0mm]</p>

[SW] = Available in Solid Wood. [MDF] = Available in Medium Density Fiberboard (MDF). [C] = Available for Convex/Concave products. [AS] = Available on Adventure Series Doors.

► For PRICING ► See Section E.1 in our current Wholesale Pricing Catalog.

Profile Options

Stile & Rail - "Traditional" Mortise & Tenon Joinery

3/4" [19.3mm] Thick "Traditional" Door and Frame Construction

Raised & Flat Panel Stile & Rail Profile

Frame GRF Profile

Standard Lite Mullion

True Lite Mullion

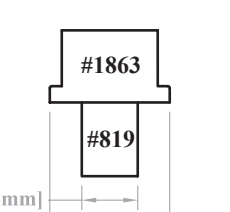
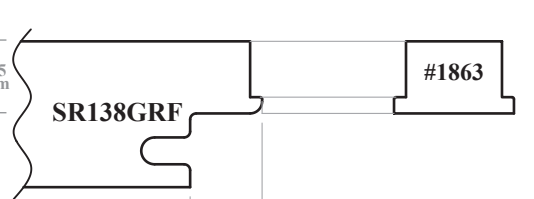
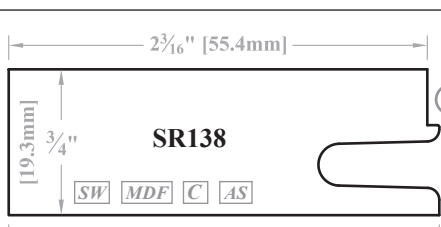
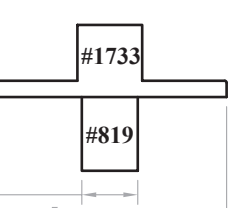
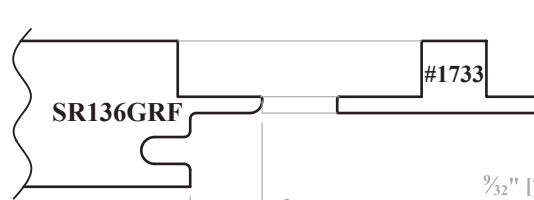
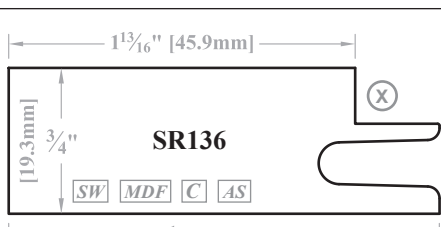
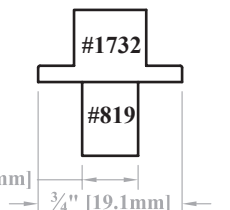
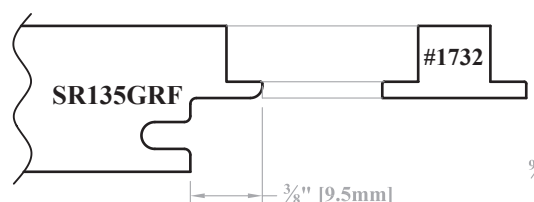
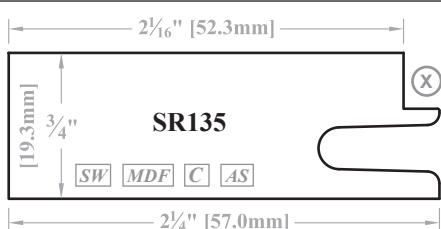
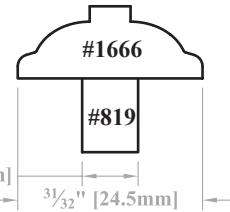
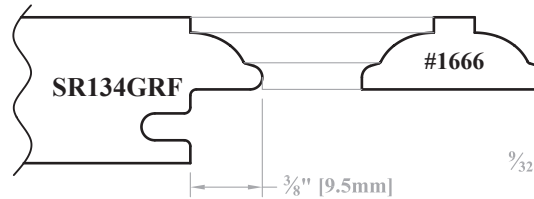
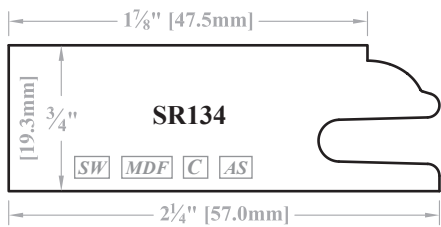
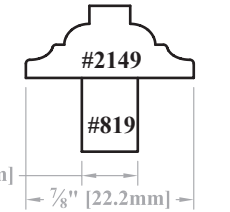
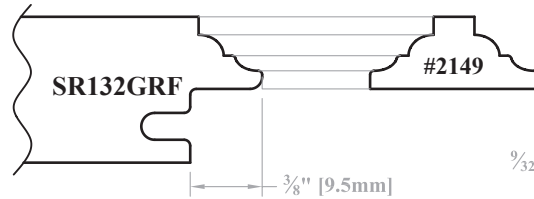
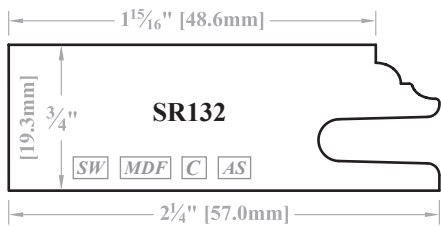
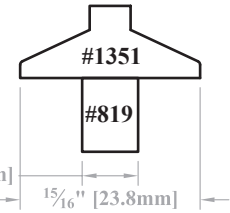
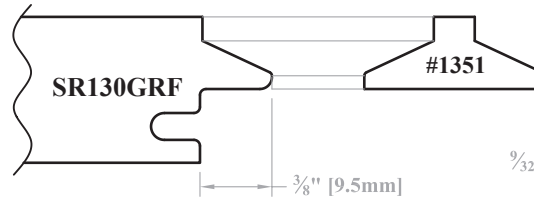
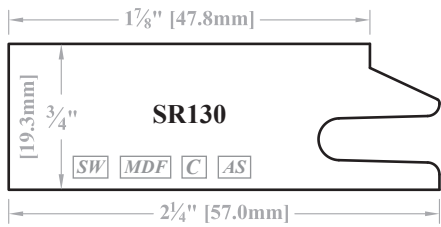

SW = Available in Solid Wood. MDF = Available in Medium Density Fiberboard (MDF). C = Available for Convex/Concave products. X = Applied Molding Shelf, molding is optional.

► For PRICING ► See Section E.1 in our current Wholesale Pricing Catalog.

3/4" [19.3mm] Thick "Traditional" Door and Frame Construction

Raised & Flat Panel Stile & Rail Profile

Frame GRF Profile

Standard Lite Mullion

True Lite Mullion

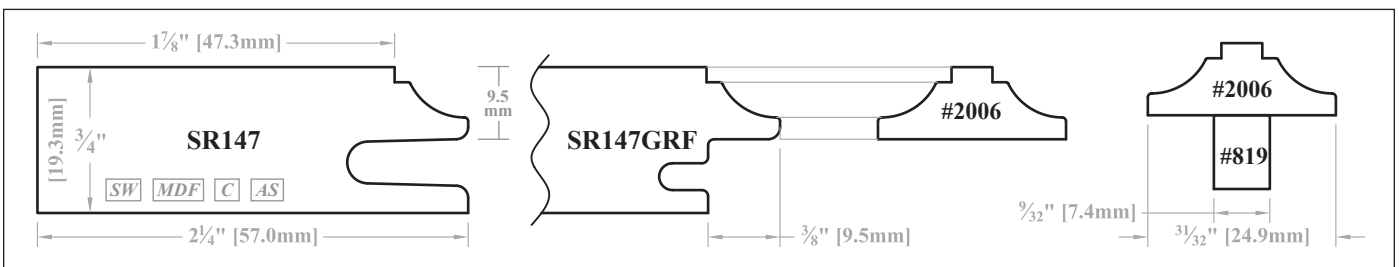
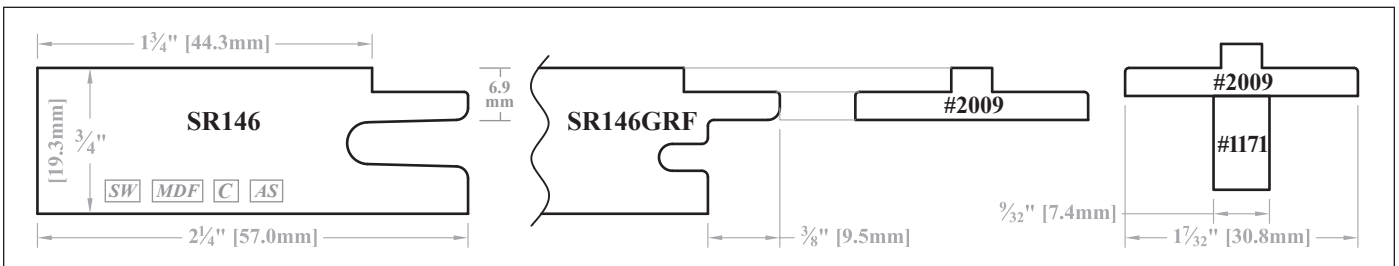
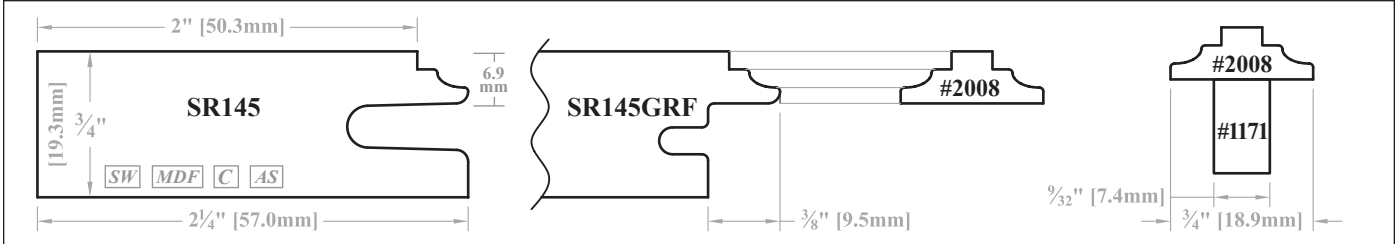
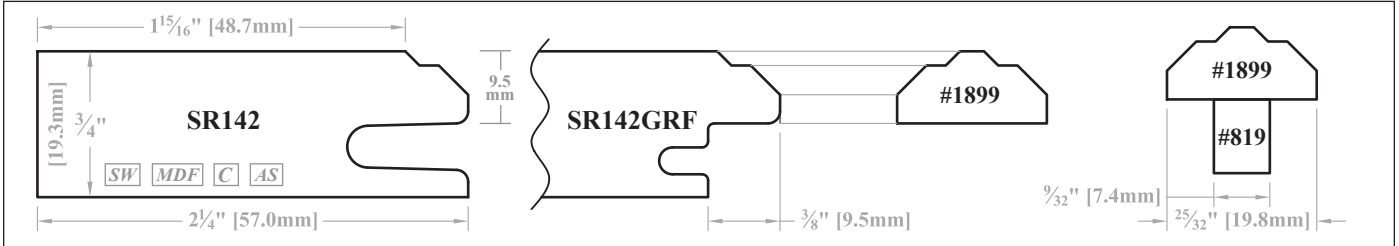
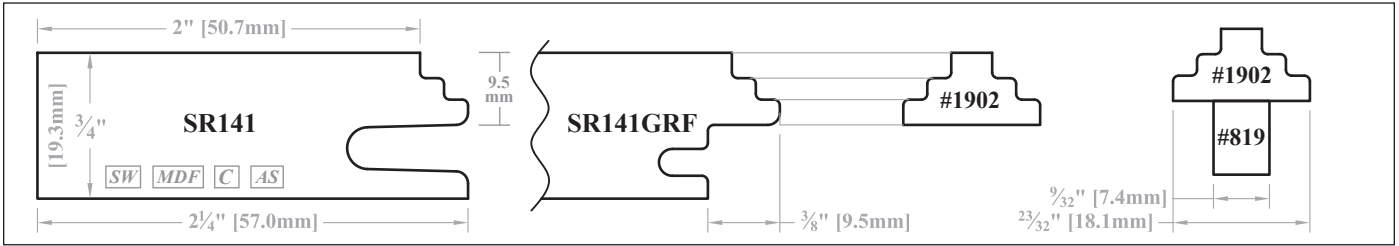
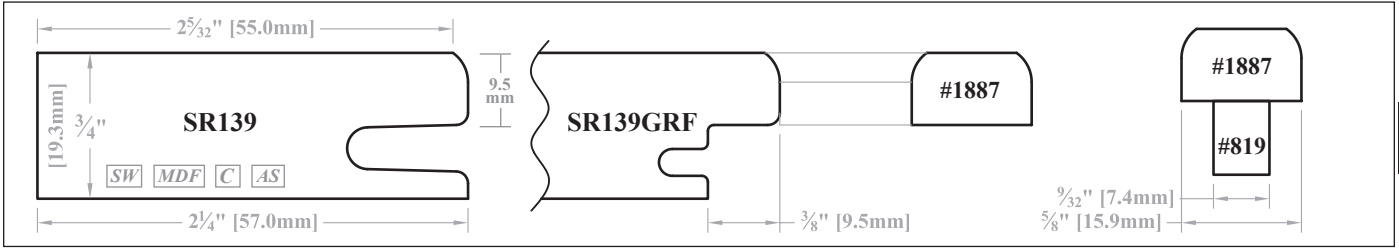

SW = Available in Solid Wood. MDF = Available in Medium Density Fiberboard (MDF). C = Available for Convex/Concave products. AS = Available on Adventure Series Doors.

► For PRICING ► See Section E.1 in our current Wholesale Pricing Catalog.

E

Profile Options

Stile & Rail - "Traditional" Mortise & Tenon Joinery

3/4" [19.3mm] Thick "Traditional" Door and Frame Construction

Raised & Flat Panel Stile & Rail Profile

Frame GRF Profile

Standard Lite Mullion

True Lite Mullion

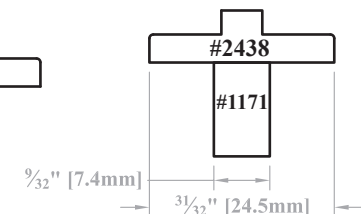
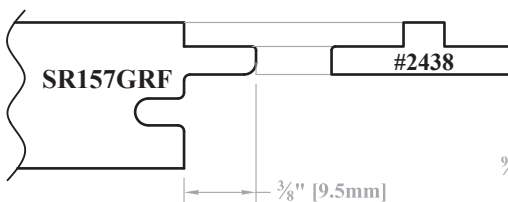
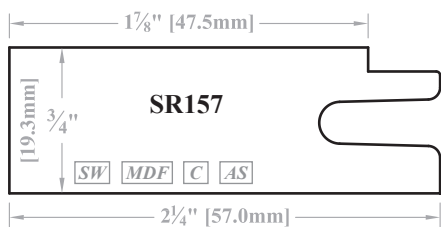
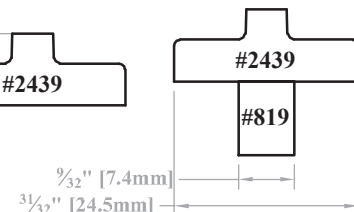
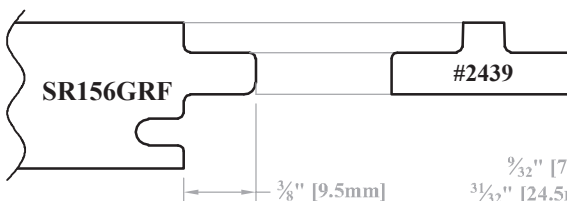
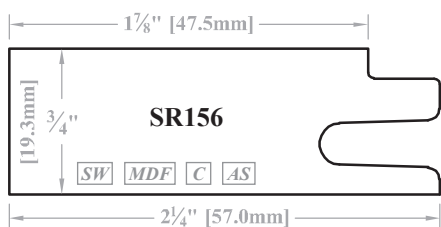
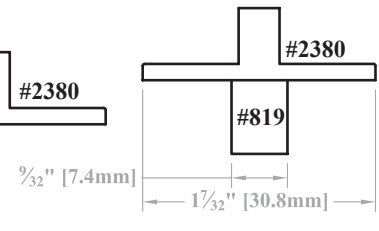
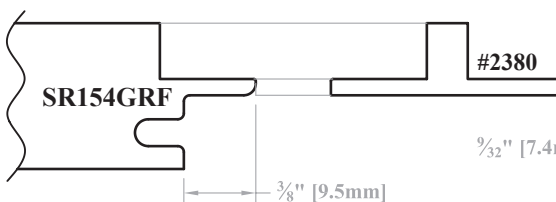
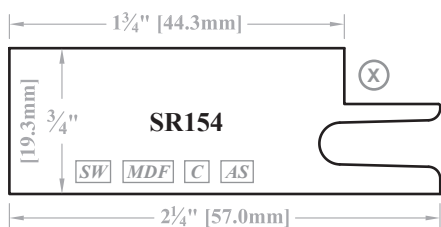
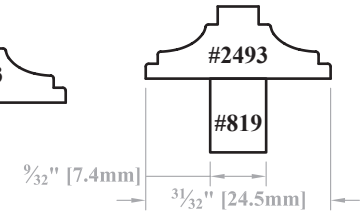
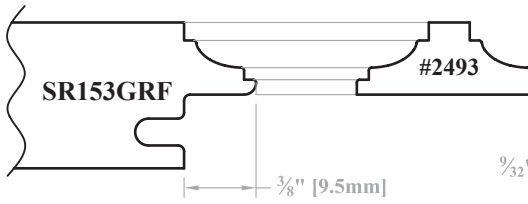
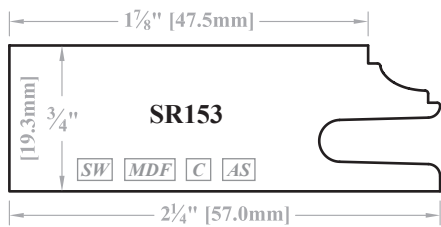
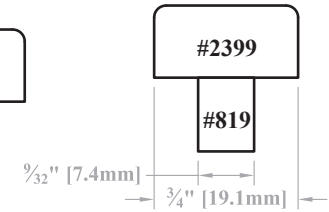
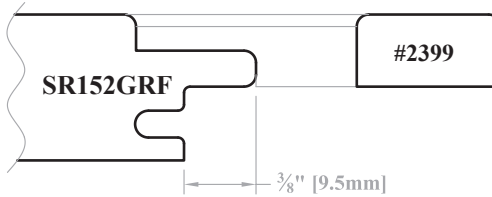
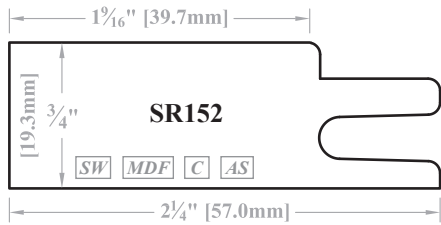
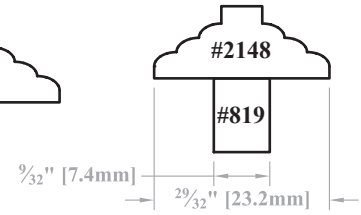
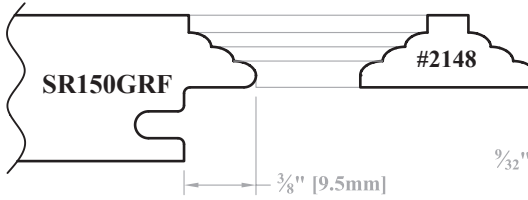
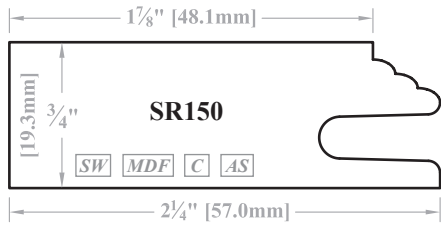

SW = Available in Solid Wood. MDF = Available in Medium Density Fiberboard (MDF). X = Applied Molding Shelf, molding is optional. AS = Available on Adventure Series Doors.

► For PRICING ► See Section E.1 in our current Wholesale Pricing Catalog.

3/4" [19.3mm] Thick "Traditional" Door and Frame Construction

Raised & Flat Panel Stile & Rail Profile

Frame GRF Profile

Standard Lite Mullion

True Lite Mullion

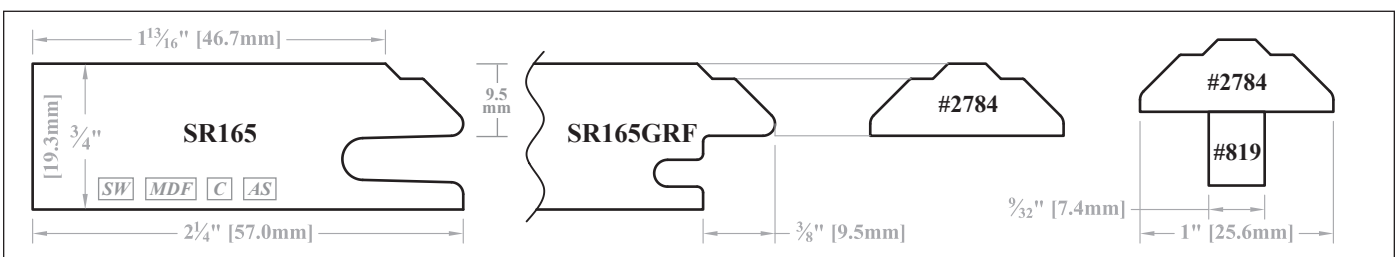
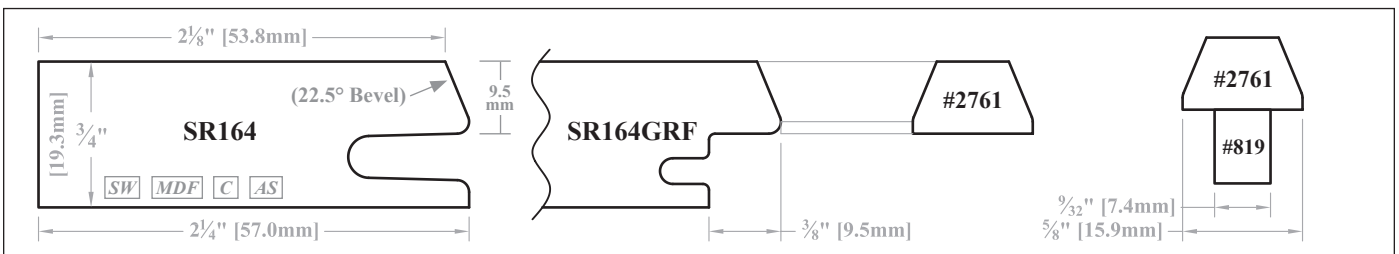
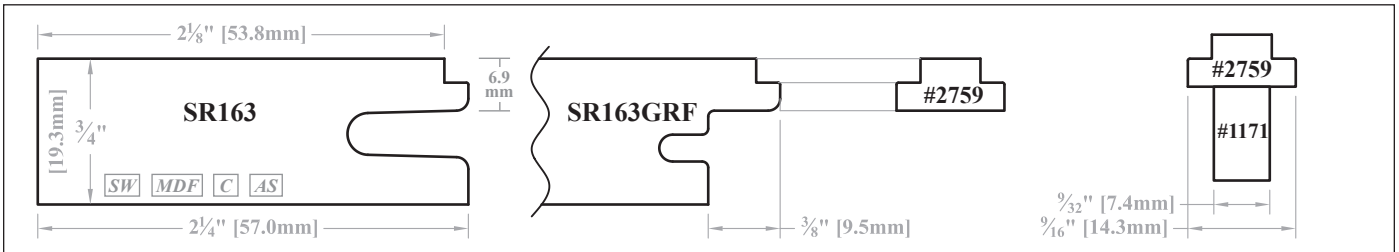
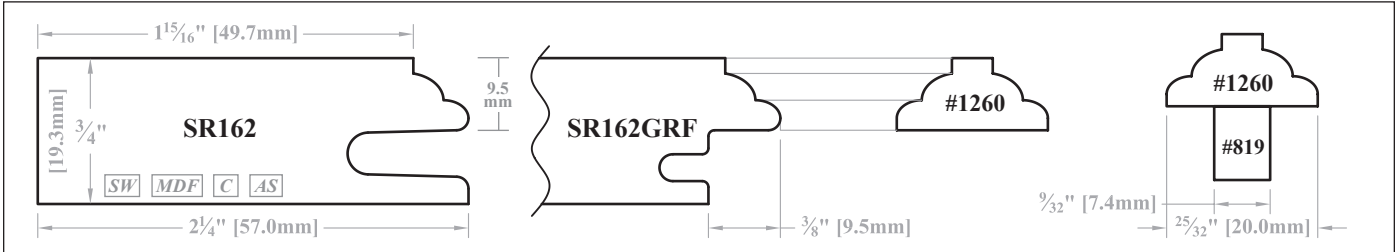
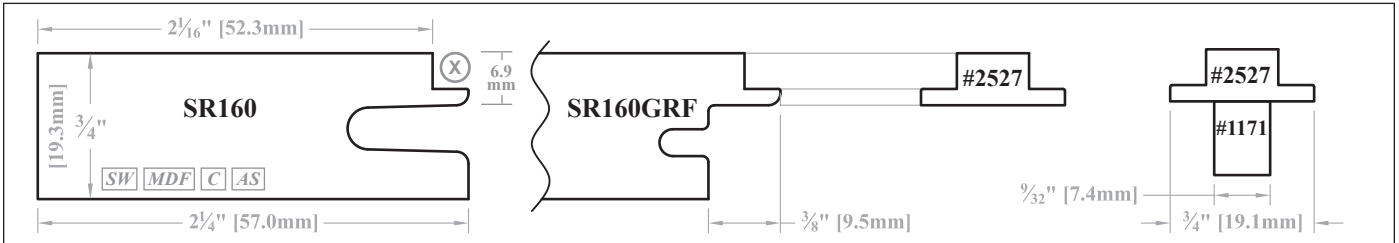
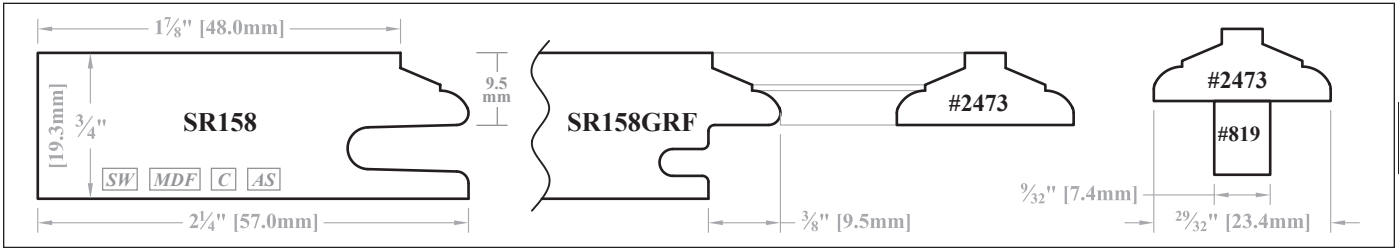

SW = Available in Solid Wood. MDF = Available in Medium Density Fiberboard (MDF). C = Available for Convex/Concave products. R-FM = French Miter Recommended.

► For PRICING ► See Section E.1 in our current Wholesale Pricing Catalog.

E

Profile Options

Stile & Rail - "Traditional" Mortise & Tenon Joinery

3/4" [19.3mm] Thick "Traditional" Door and Frame Construction

Raised & Flat Panel Stile & Rail Profile

Frame GRF Profile

Standard Lite Mullion

True Lite Mullion

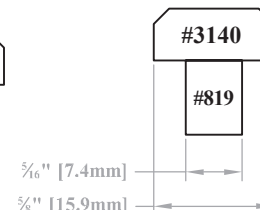
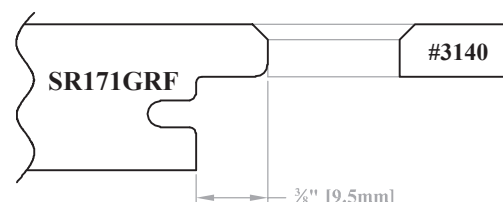
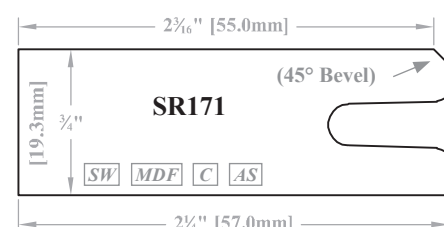
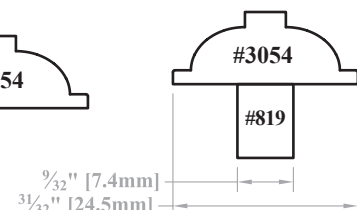
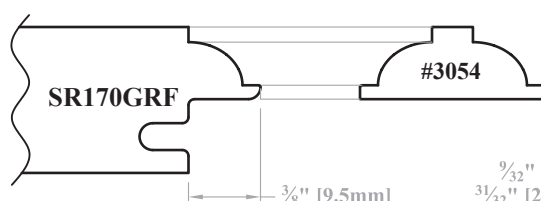
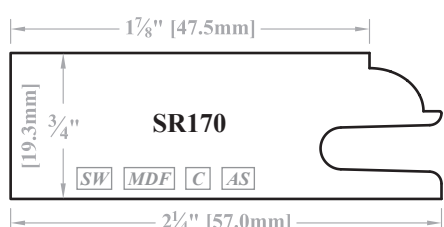
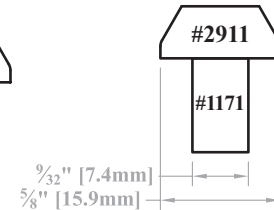
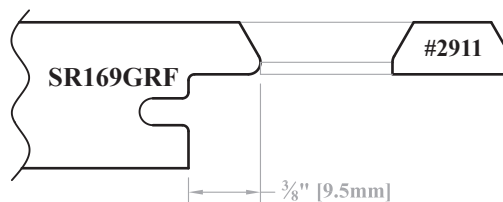
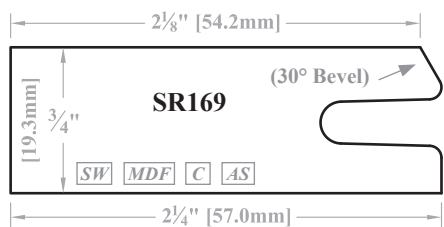
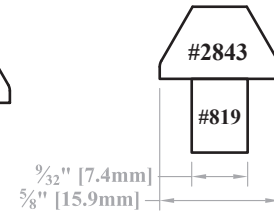
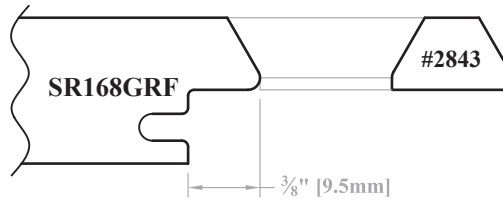
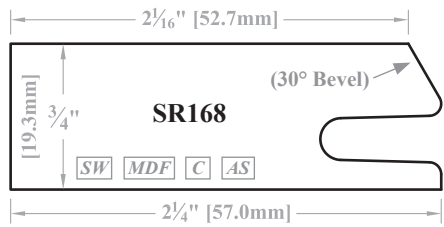
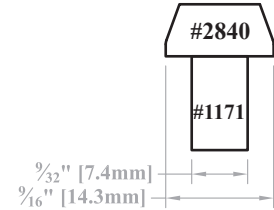
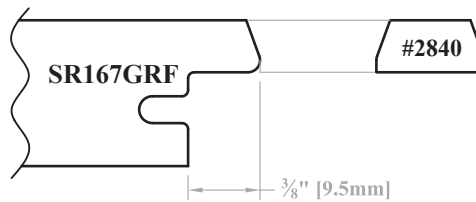
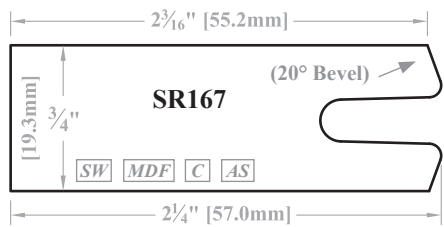
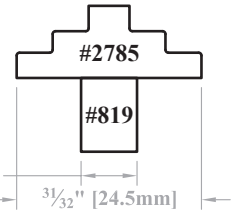
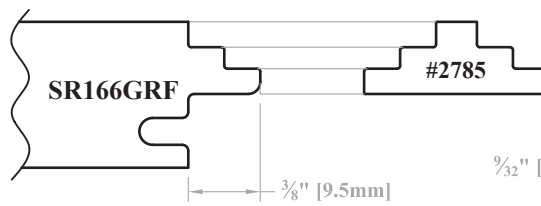
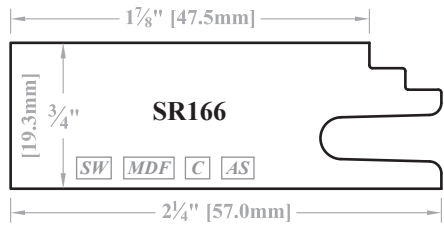

SW = Available in Solid Wood. MDF = Available in Medium Density Fiberboard (MDF). C = Available for Convex/Concave products. AS = Available on Adventure Series Doors.

► For PRICING ► See Section E.1 in our current Wholesale Pricing Catalog.

Stile & Rail - "Traditional" Mortise & Tenon Joinery

Profile Options

3/4" [19.3mm] Thick "Traditional" Door and Frame Construction

Raised & Flat Panel Stile & Rail Profile

Frame GRF Profile

Standard Lite Mullion

True Lite Mullion

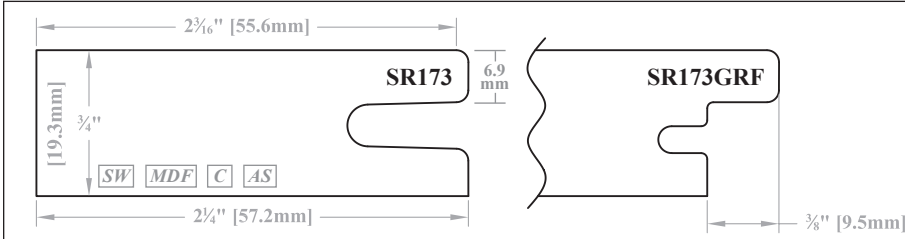

Matching mullion stock is not available for this profile.

3/4" [19.1mm] Thick "Traditional" Door and Frame Construction - "Only" Available with Applied Molding

Raised & Flat Panel Stile & Rail Profile

Frame GRF Profile

Standard Lite Mullion

True Lite Mullion

#1664 Applied Molding

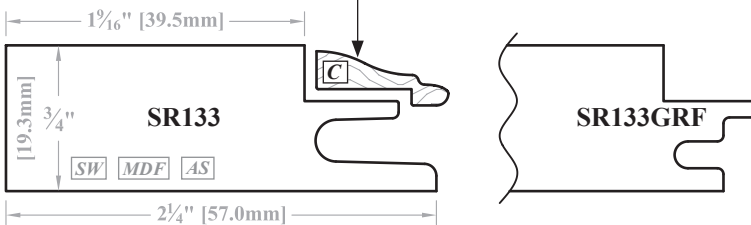

See Section E.5 for Matching Mullion Stock options.

#2405 Applied Molding

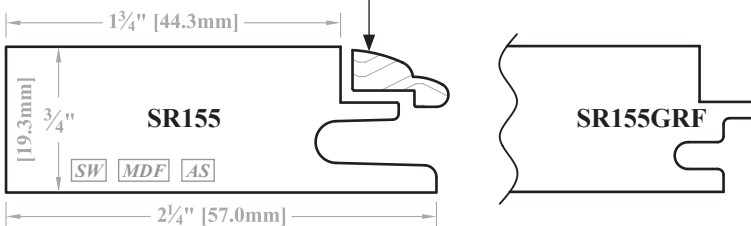

* Applied Molding #2405 is not available with Shaped Rails.

See Section E.5 for Matching Mullion Stock options.

SW = Available in Solid Wood. MDF = Available in Medium Density Fiberboard (MDF). C = Available for Convex/Concave products. AS = Available on Adventure Series Doors.

► For PRICING ► See Section E.1 in our current Wholesale Pricing Catalog.

Profile Options

Stile & Rail - "Traditional" Mortise & Tenon Joinery

Ordering & Pricing Notes: 3/4" [19.3mm] Thick "Traditional" Stile & Rail Profiles

Ordering Guidelines

1	Order Forms	Applicable order forms will include spaces to indicate your chosen profiles.
Pricing		
1	Pricing	Please see <i>Section E.1</i> of our current Wholesale Pricing Catalog.

Technical Notes: 3/4" [19.3mm] Thick "Traditional" Stile & Rail Profiles

Cabinet Door & Drawer Front Options (Chapter B)

1	French Miter	<p>[R-FM] = Recommended French Miter. Due to the nature of these profiles, in order to provide a more quality oriented joint, WalzCraft recommends that they be ordered as French Miter construction. Please see <i>Section B.7</i> for more information on French Miter doors. The French Miter joint represents a step up in quality and will provide a much cleaner look. If choosing to order these R-FM profiles with French Miter construction, please use the matching French Miter door style along with the matching miter profile. For example, if you want a Style 10 door with stile & rail profile SR119, but made with French Miter construction, please order door style 10FM with mitered stile & rail profile MP603-57 (<i>page E.9.2</i>).</p> <ul style="list-style-type: none"> • SR108 matches MP618-57, SR119 matches MP603-57, SR121 matches MP626-57, and SR127 matches MP637-57. • If applying to a convex/concave door, the profiles will need to remain traditional (SR108, SR119, SR121, SR127). <p>French Miter construction is only available on square door styles (Ex: Style 10), and is not available on doors styles with shaped rails (Ex: Style 2000).</p> <p>Minimum rail length for doors with French Miter construction is 5 1/2".</p> <p>Electing to have a door built with French Miter construction will result in the door being priced using French Miter pricing. The door will be more expensive than a Traditional Mortise & Tenon door.</p>
2	Adventure Series	[AS] = These profile options are available on Adventure series doors. See <i>Section B.7</i> for more information.
3	Gothic Door Styles 4100, 4200, 9100 and 9200	For Stile and Rail Profile availability, see our website under: Resources/Technical Information.

Convex/Concave Options (Chapter D)

1	Curved Products	The [C] indicates profiles that are available for Convex/Concave products. For additional ordering guidelines, see <i>Chapter D</i> .
---	-----------------	--

Material Options

1	Material Options	<p>[SW] = Profile is available on products made from solid wood.</p> <p>[MDF] = Profile is available on products made from MDF (Medium Density Fiberboard).</p>
---	------------------	---

Profile Options (Chapter E)

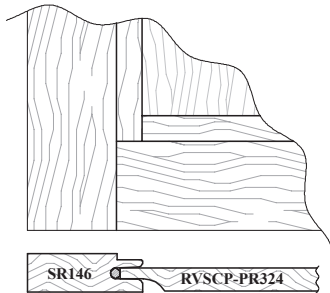
1	Profile Drawings	All stile & rail and mullion stock drawings are shown at full scale.
2	Mitered Stile & Rail Profiles	See <i>Sections E.9, E.10 and E.11</i> for mitered stile and rail profiles.
3	Applied Molding Shelf	(X) = indicates that a shelf applied molding can be used. See <i>Section E.4</i> for more information.
4	SR101, SR117, SR122, SR135, SR136, SR146, SR152, SR154, SR156, SR157	<p>When choosing one of these "shelf" stile & rail profiles, the mortise & tenon joint will appear as shown in the example to the right (<i>not drawn to scale</i>):</p> 

Continued on next page...

► For PRICING ► See *Section E.1* in our current Wholesale Pricing Catalog.

Technical Notes: 3/4" [19.3mm] Thick "Traditional" Stile & Rail Profiles...continued

Profile Options (Chapter E)...continued

5	SR104, SR118	Center panels will be <i>flush</i> with the face of stiles and rails when using these center panel profiles: <ul style="list-style-type: none"> • PR318-25, PR319-10, PR320-25, PR320-32, PR320-44, PR321-32, PR328-32 or PR329-19. ◦ Available in solid wood, raw MDF and MDF - MR (Moisture Resistant), Raw.
		Center panels will be <i>recessed</i> below the face of the stiles and rails when using these center panel profiles: <ul style="list-style-type: none"> • RVSCP-PR324 (<i>Reversed Solid Center Panel</i>) ◦ Available in solid wood, raw MDF and MDF - MR (Moisture Resistant), Raw. • 1/4" [6.4mm] Flat Panel ◦ Available in veneer, raw MDF and MDF - MR (Moisture Resistant), Raw.
		SR104 and SR118 are only compatible with the center panel profiles noted above.
6	SR123, SR145, SR146, SR157, SR160, SR163, SR167, SR169, SR171, SR173	Center panels will be <i>recessed</i> below the face of the stiles and rails when using these center panel profiles: <ul style="list-style-type: none"> • PR318-25, PR319-10, PR320-25, PR320-32, PR320-44, PR321-32, PR328-32, PR329-19, RVSCP-PR324 (<i>Reversed Solid Center Panel</i>) ◦ Available in solid wood, raw MDF and MDF - MR (Moisture Resistant), Raw. • 1/4" [6.4mm] Flat Panel ◦ Available in veneer, raw MDF and MDF - MR (Moisture Resistant), Raw.
		SR123, SR145, SR146, SR157, SR160, SR163, SR167, SR169, SR171, SR173 are only compatible with the center panel profiles listed above.
7	SR117, SR122, SR135, SR136, SR138, SR154, SR160	Applied moldings are not included with these profiles and must be ordered separately. For Applied Mold-ing options, see <i>Section E.5</i> .
8	SR133, SR155	Only available with Applied Molding.
		All standard Center Panel Profile Reveals are compatible with the Applied Moldings designed for the SR133 and SR155 shelf. For additional Applied Molding options, see <i>Section E.5</i> .
9	Frame "GRF" Profiles	Frame GRF profiles will accept 1/8" [3.2mm] glass if using rubber retainer.
		To order, mark the box (X) for Frame Only or indicate the Mullion Lite Pattern (<i>ie: 2 x 3</i>) or LP Option (<i>ie: LP105</i>) in the box provided on your order form.
		For mullions, denote the # of Lites and whether they are Standard (S) or True Lite (TL). <ul style="list-style-type: none"> • True Lites are 2-piece construction.

Sizes/Dimensions

1	Standard Stile and Rail Dimensions and Non-Standard Parts	Traditional stile and rail dimensions are 2 1/4" [57.2mm] wide. Traditional stiles and rails can be ordered from 1 1/2" [38.1mm] wide to 10" [254.0mm] wide in 1/4" [6.4mm] increments without incurring a Non-Standard part size charge. See <i>Section A.5</i> for more information.
		The minimum <i>width</i> , at the narrowest point, for any top/bottom rail with or without a "GRF" cut is 1 1/4" [31.8mm].
		The minimum <i>width</i> , at the narrowest point, for any outside stile, center stile or center rail with or without a "GRF" cut is 1 1/2" [38.1mm].
		A 1 1/4" [44.5m] minimum is required for hinge boring (<i>Section F.1</i>).
2	Minimum Length	The minimum <i>visual length</i> for a top or bottom rail and a center stile or rail is 2 1/8" [54mm].
3	Part Sizes	Stile and rail widths and lengths are determined by measuring across the back of the stiles and rails only.

Stile & Rail - Traditional Mortise & Tenon Joinery - END

► For PRICING ► See Section E.1 in our current Wholesale Pricing Catalog.

Profile Options

Stile & Rail - "Traditional" Mortise & Tenon Joinery - Mirror Joints

3/4" Thick "Traditional" Door and Frame Construction - Mirror Joints

Raised and Flat Panel Door Stile & Rail Joint

Frame GRF Profile

Standard Lite Mullion

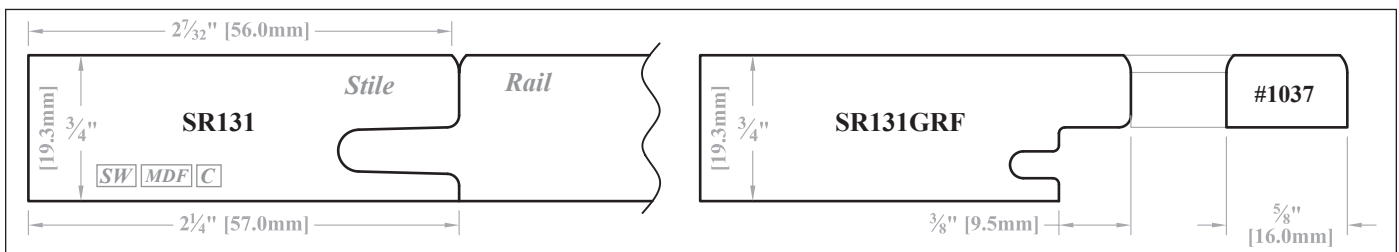
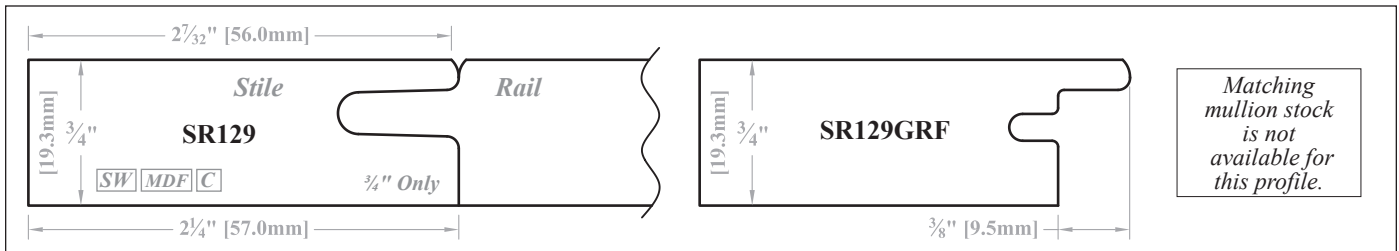
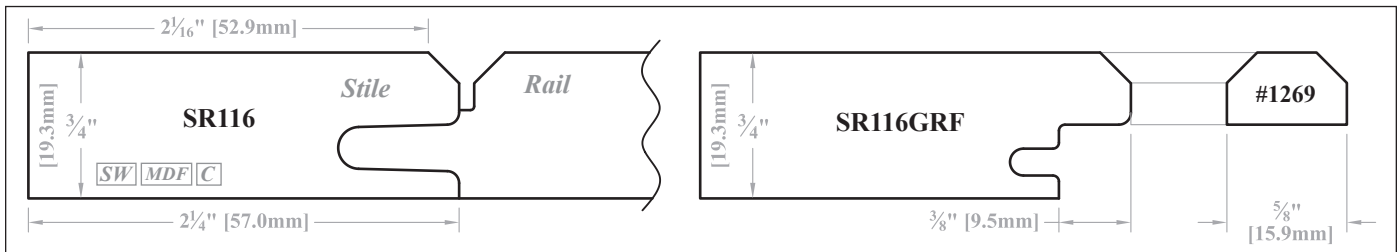
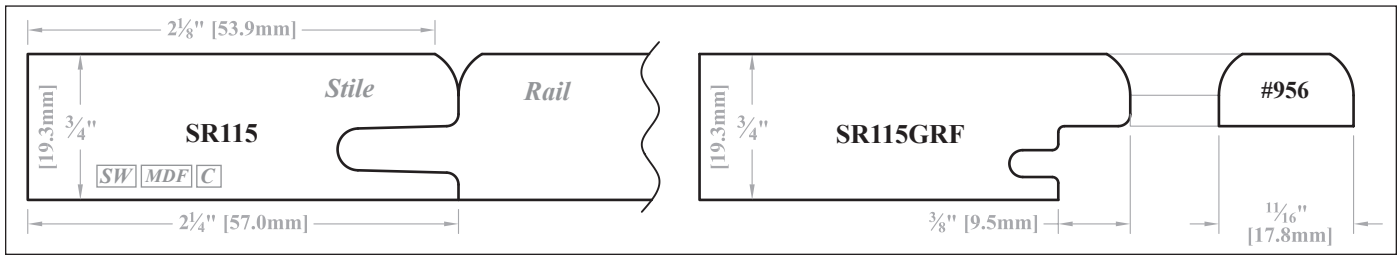
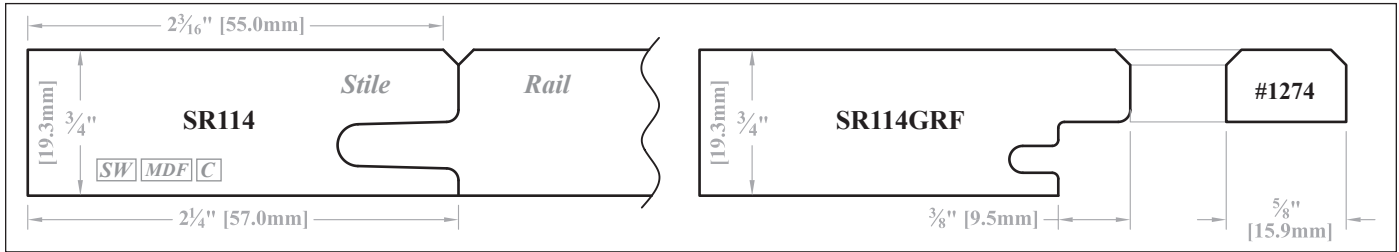
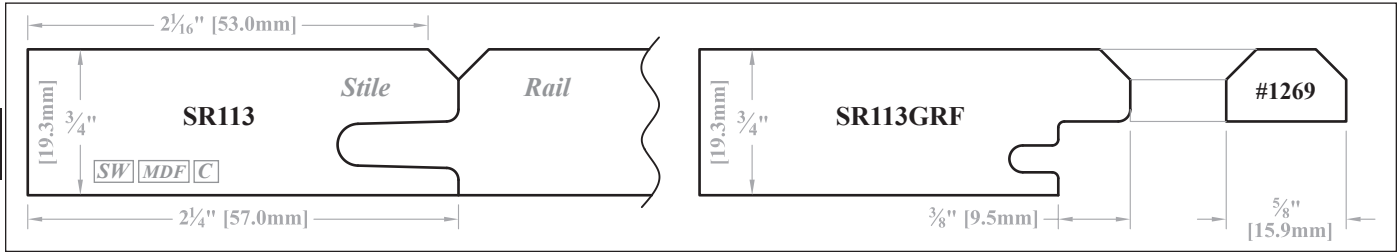

[SW] = Available in Solid Wood.

[MDF] = Available in Medium Density Fiberboard (MDF).

[C] = Available for Convex/Concave Products.

► For PRICING ► See Section E.2 in our current Wholesale Pricing Catalog.



3/4" Thick "Traditional" Door and Frame Construction - Mirror Joints

Raised and Flat Panel Door Stile & Rail Joint Frame GRF Profile Standard Lite Mullion

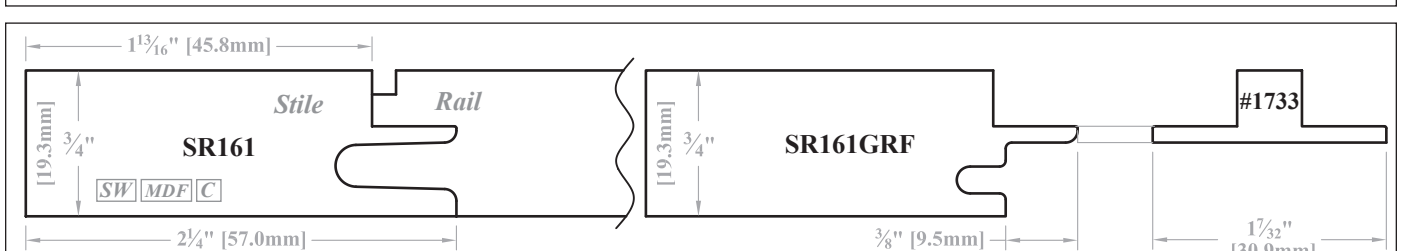
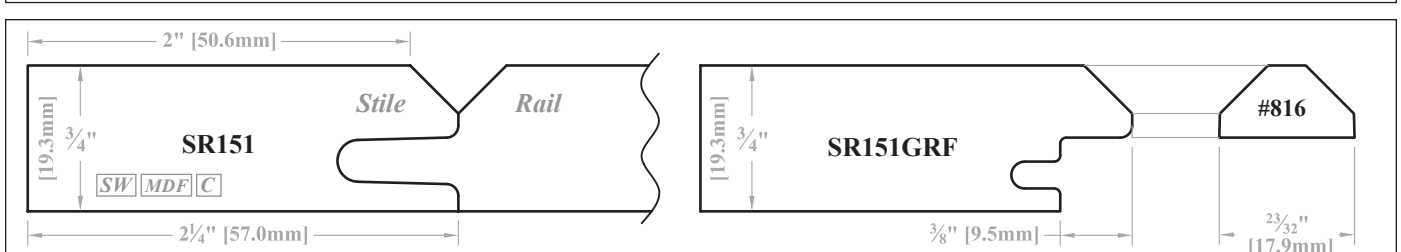
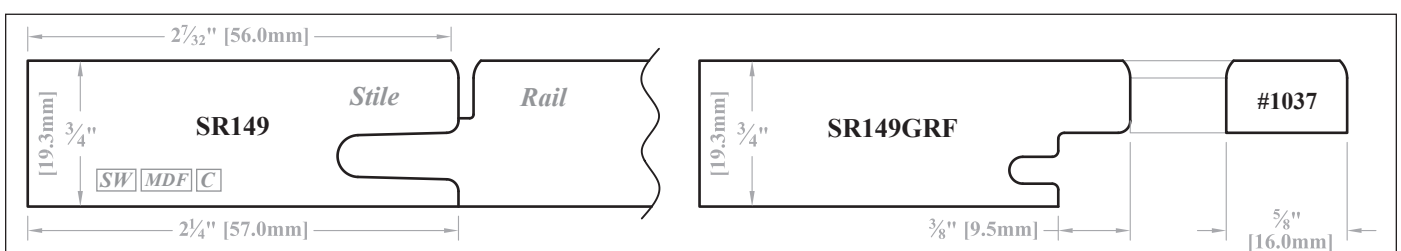
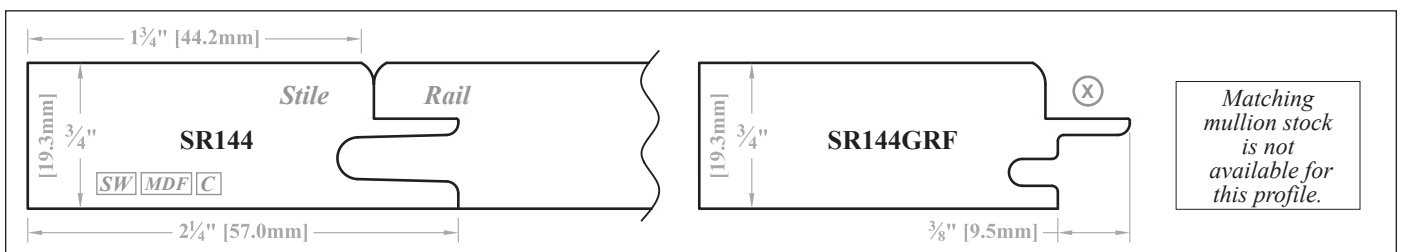
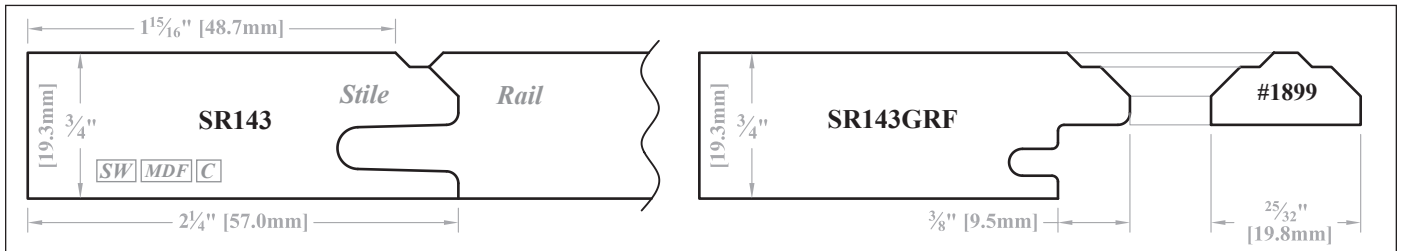
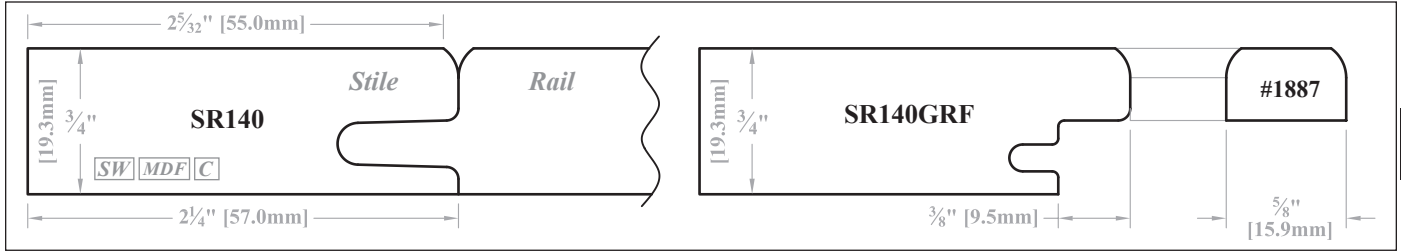

[SW] = Available in Solid Wood. [MDF] = Available in Medium Density Fiberboard (MDF). [C] = Available for Convex/Concave Products.

► For PRICING ► See Section E.2 in our current Wholesale Pricing Catalog.

Profile Options

Stile & Rail - "Traditional" Mortise & Tenon Joinery - Mirror Joints

Raised and Flat Panel Door Stile & Rail Joint

Frame GRF Profile

Standard Lite Mullion

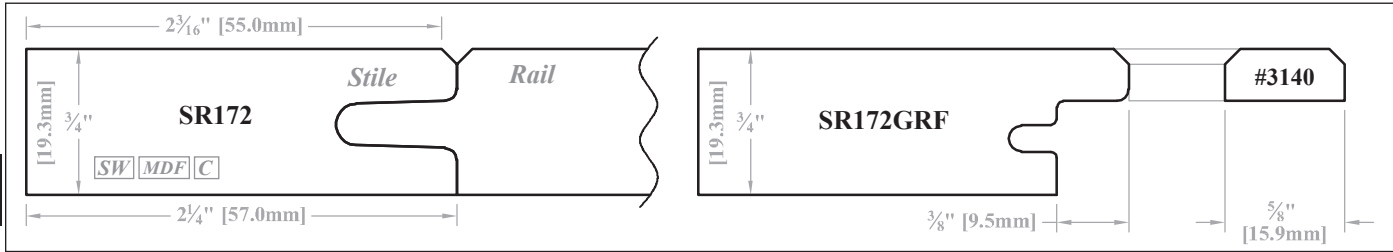

Ordering & Pricing Notes: 3/4" [19.3mm] Thick "Traditional" Stile & Rail Profiles - Mirror Joints

Ordering Guidelines

1	Order Forms	Applicable order forms will include spaces to indicate your chosen profiles.
Pricing		
1	Pricing	Please see <i>Section E.2</i> of our current Wholesale Pricing Catalog.

Technical Notes: 3/4" [19.3mm] Thick "Traditional" Stile & Rail Profiles - Mirror Joints

Cabinet Door & Drawer Front Options (Chapter B)

1	Quarter and Half Circle Doors	Mirror Joints are not available with the following door styles: 895L/R, 896L/R, 897L/R, 1890, 1896, 995L/R, 996L/R, 997L/R, 1990, 1996.
2	Door Styles 1800, 1801, 1400, 1401	Please check hinge bore placement compatibility when increasing the width of top and bottom rails.

Convex/Concave Options (Chapter D)

1	Curved Products	The C indicates profiles that are available for Convex/Concave Products. For additional ordering guidelines, see <i>Chapter D</i> .
---	-----------------	---

Material Options

1	Material Options	SW = Profile is available on products made from solid wood. MDF = Profile is available on products made from MDF (Medium Density Fiberboard).
---	------------------	--

Profile Options (Chapter E)

1	Profile Drawings	All stile & rail and mullion stock drawings are shown at full scale.
2	Miter Stile & Rail Profiles	Mitered door construction requires the use of mitered stile & rail profiles, see <i>Sections E.9 - E.11</i> .
3	SR129	Center panels will be flush with the face of stiles and rails when using these center panel profiles: • PR318-25, PR319-10, PR320-25, PR320-32, PR320-44, PR321-32, PR328-32 or PR329-19. ◦ Available in solid wood and raw MDF.
		Center panels will be recessed below the face of the stiles and rails when using these center panel profiles: • RVSCP-PR324 (<i>Reversed Solid Center Panel</i>) ◦ Available in solid wood, raw MDF and MDF - MR (Moisture Resistant), Raw. • 1/4" [6.4mm] Flat Panel ◦ Available in veneer, raw MDF and MDF - MR (Moisture Resistant), Raw.
		SR129 is only compatible with the center panel profiles noted above.
4	SR172	Center panels will be recessed below the face of the stiles and rails when using these center panel profiles: • PR318-25, PR319-10, PR320-25, PR320-32, PR320-44, PR321-32, PR328-32, PR329-19, RVSCP-PR324 (<i>Reversed Solid Center Panel</i>) ◦ Available in solid wood, raw MDF and MDF - MR (Moisture Resistant), Raw. • 1/4" [6.4mm] Flat Panel ◦ Available in veneer, raw MDF and MDF - MR (Moisture Resistant), Raw.
		SR172 is only compatible with the center panel profiles listed above.

Continued on next page...

SW = Available in Solid Wood. MDF = Available in Medium Density Fiberboard (MDF). C = Available for Convex/Concave Products.

► For PRICING ► See *Section E.2* in our current Wholesale Pricing Catalog.

Technical Notes: 3/4" [19.3mm] Thick "Traditional" Stile & Rail Profiles - Mirror Joints...continued

Profile Options (Chapter E)...continued

5	Frame GRF Profiles	Frame GRF profiles will accept 1/8" glass if using rubber retainer.
		To order, mark the box (X) for Frame Only or indicate the Mullion Lite Pattern (ie: 2 x 3) or LP Option (ie: LP105) in the box provided on your Order Form.
		For mullions, denote the # of Lites and whether they are Standard (S) or True Lite (TL). <ul style="list-style-type: none"> • True Lites are 2-piece construction.

Sizes/Dimensions

1	Standard Stile and Rail Dimensions and Non-Standard Parts	Traditional stile and rail dimensions are 2 1/4" [57.2mm] wide. Traditional stiles and rails can be ordered from 1 1/2" [38.1mm] wide to 10" [254.0mm] wide in 1/4" [6.4mm] increments without incurring a Non-Standard part size charge. Please see Non-Standard Part Sizes in Section A.5 for more information.
		The minimum width , at the narrowest point, for any top/bottom rail with or without a GRF cut is 1 1/4" [31.8mm].
		The minimum width , at the narrowest point, for any outside stile, center stile or center rail with or without a GRF cut is 1 1/2" [38.1mm].
		A 1 3/4" [44.5mm] minimum is required for hinge boring (Section F.1).
		The minimum distance for the flat surface between the stile and rail profile and the outside edge profile is 3/16" [4.8mm], this factor may also affect the minimum size required for hinge boring. Please refer to our website to reference the Stile & Rail Dimension and Outside Edge Profile charts to determine the minimum stile and rail size using this formula: Stile/Rail Profile Width + 3/16" [4.8mm] Flat Surface + Outside Edge Profile Width = Minimum Stile/Rail Width.
2	Minimum Length	The minimum visual length for a top or bottom rail and a center stile or rail is 2 1/8" [54mm].
3	Part Sizes	Stile and rail widths and lengths are determined by measuring across the back of the stiles and rails only.

Stile & Rail - Traditional Mortise & Tenon Joinery - Mirror Joints - END

E

► For PRICING ► See Section E.2 in our current Wholesale Pricing Catalog.



Profile Options

Stile & Rail - "Traditional" Mortise & Tenon Joinery - Old World

1" [25.4mm] Thick "Old World" Door and Frame Construction

Raised & Flat Panel Stile & Rail Profile

Frame GRF Profile

Standard Lite Mullion

True Lite Mullion

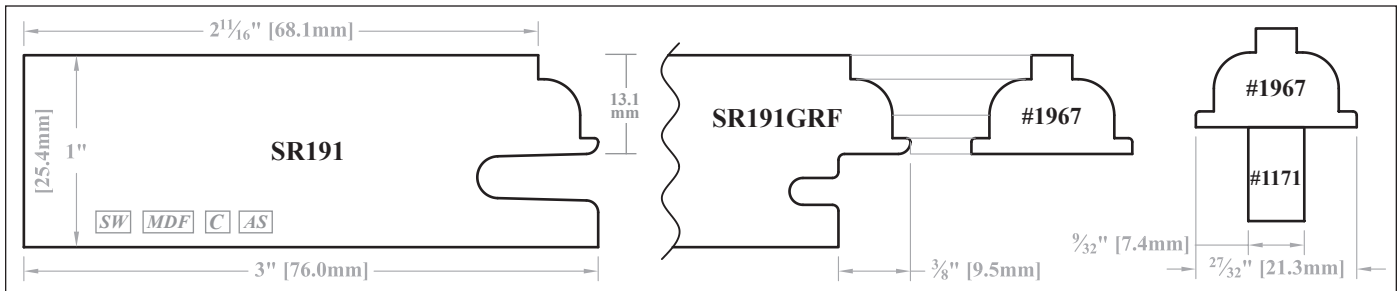
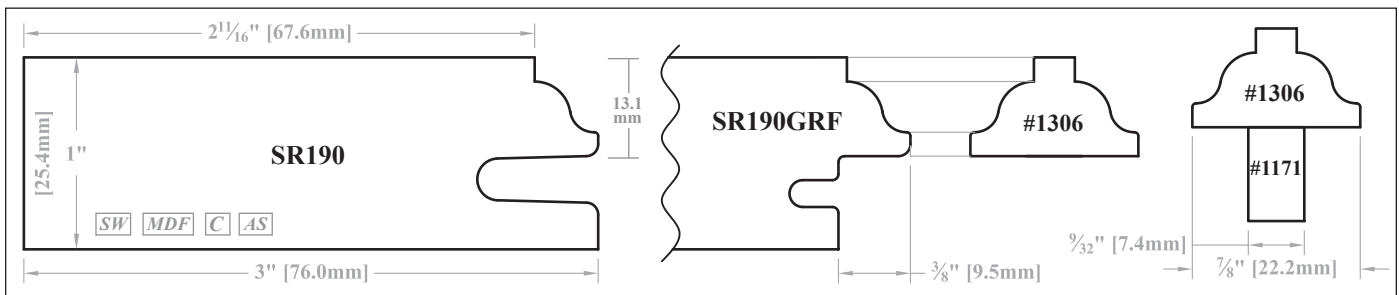
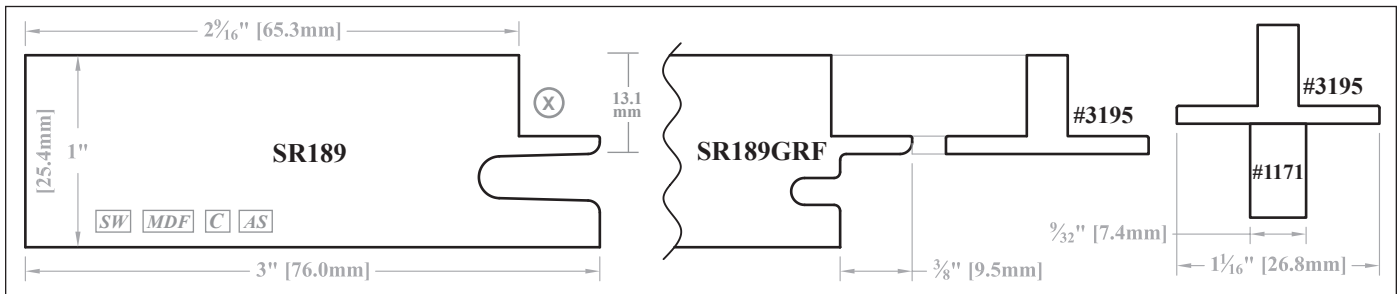
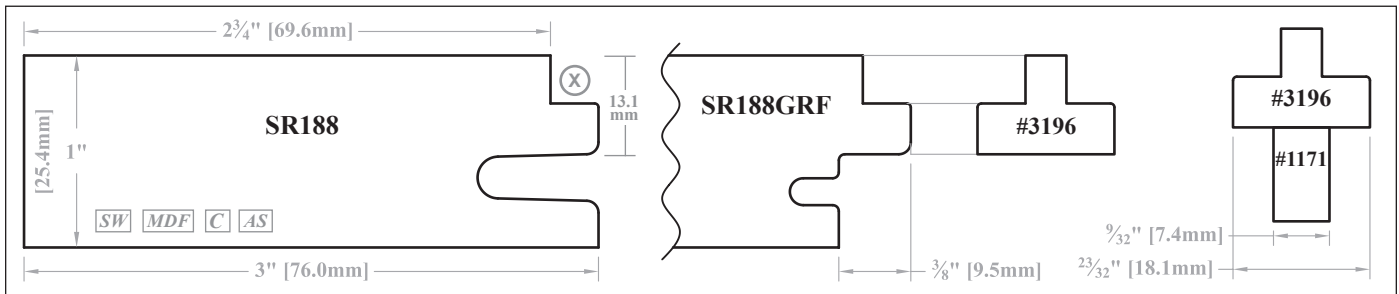
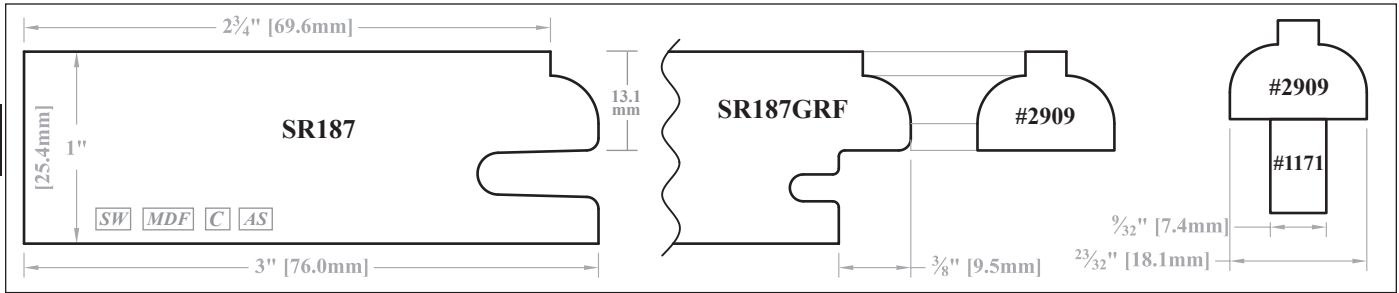

SW = Available in Solid Wood. C = Available for Convex/Concave products. AS = Available on Adventure Series Doors. X = Applied Molding Shelf, molding is optional.

► For PRICING ► See Section E.3 in our current Wholesale Pricing Catalog.

1" [25.4mm] Thick "Old World" Door and Frame Construction

Raised & Flat Panel Stile & Rail Profile

Frame GRF Profile

Standard Lite Mullion

True Lite Mullion

See Profile Options notes in Section B.12 for alternative mullion.

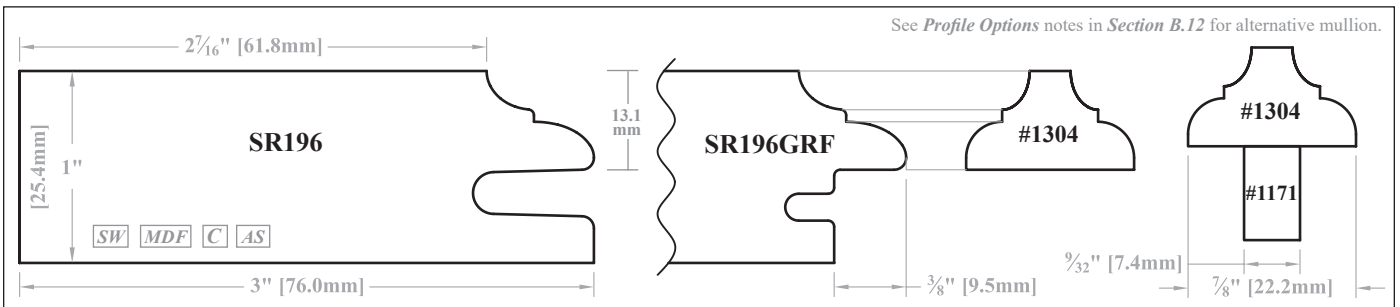
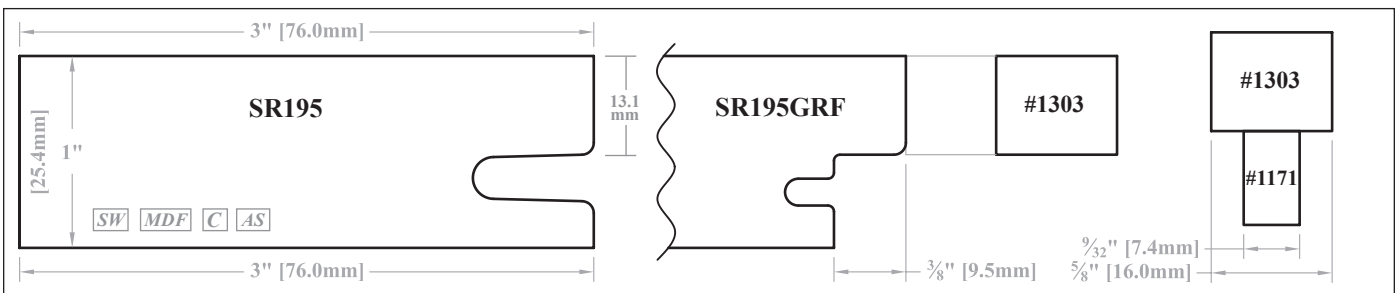
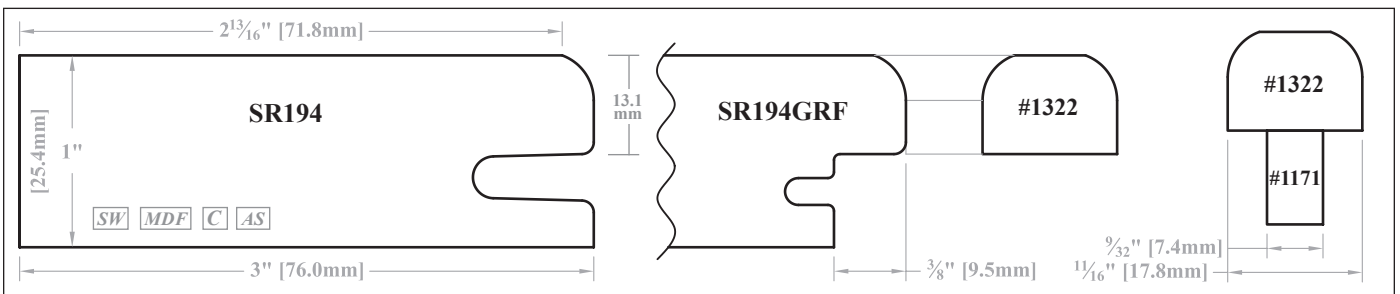
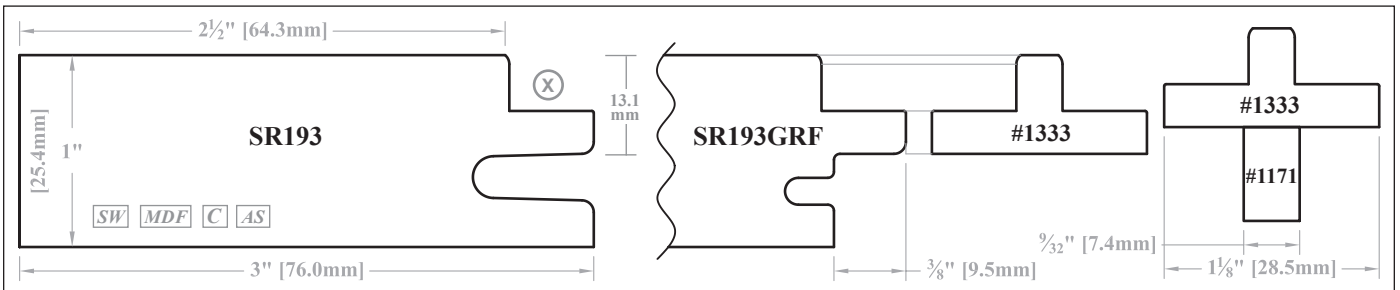
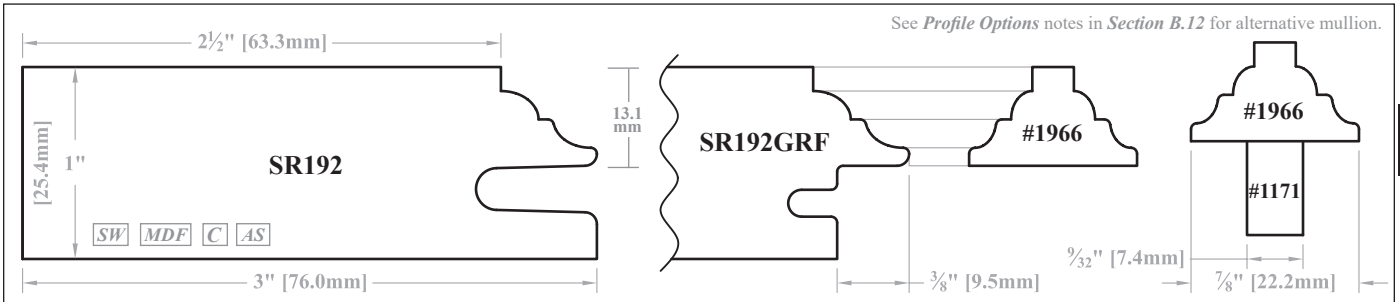

SW = Available in Solid Wood. C = Available for Convex/Concave products. AS = Available on Adventure Series Doors. X = Applied Molding Shelf, molding is optional.

► For PRICING ► See Section E.3 in our current Wholesale Pricing Catalog.

E

Profile Options

Stile & Rail - "Traditional" Mortise & Tenon Joinery - Old World

1" [25.4mm] Thick "Old World" Door and Frame Construction

Raised & Flat Panel Stile & Rail Profile

Frame GRF Profile

Standard Lite Mullion

True Lite Mullion

See Profile Options notes in Section B.12 for alternative mullion.

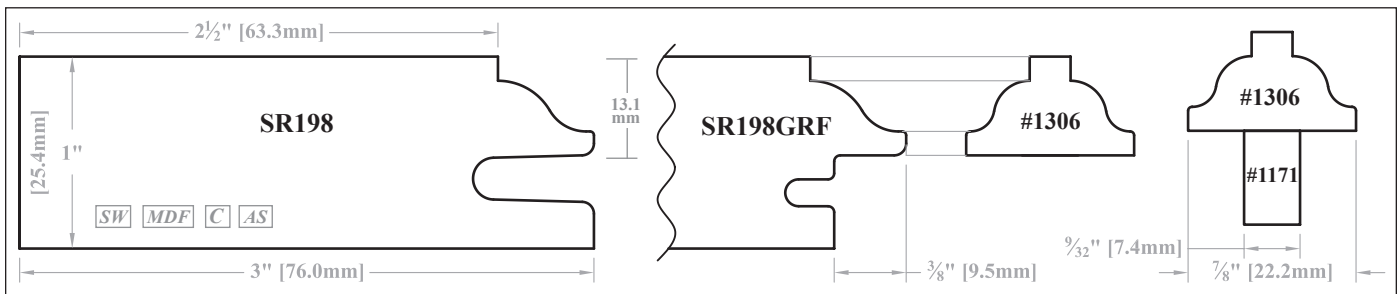
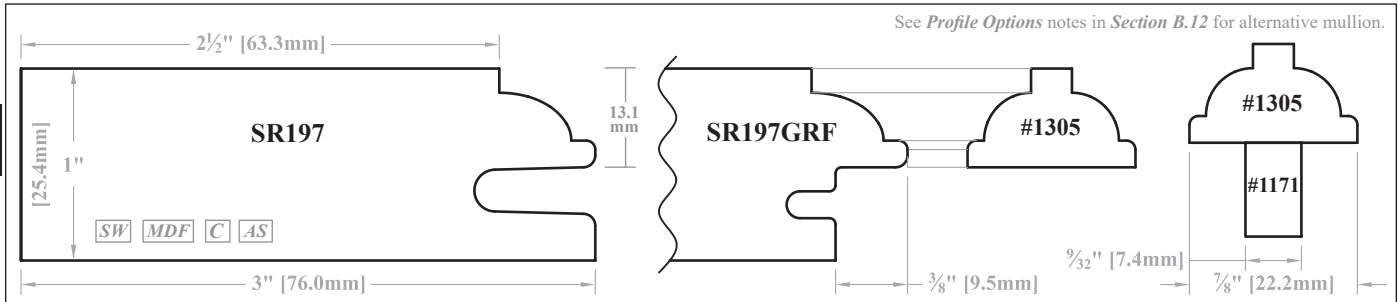

See Profile Options notes in Section B.12 for alternative mullion.

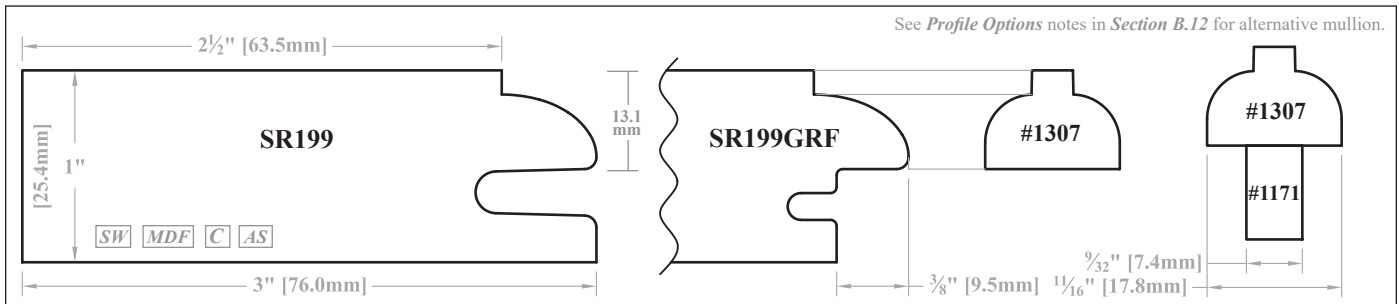

SW = Available in Solid Wood.

C = Available for Convex/Concave products.

AS = Available on Adventure Series Doors.

⊗ = Applied Molding Shelf, molding is optional.

► For PRICING ► See Section E.3 in our current Wholesale Pricing Catalog.

E.3.3
V18.2



WalzCraft.com



(Phone) 1-800-237-1326

6:00AM - 5:30PM CST

(24 Hour Fax) 1-608-781-3667

Ordering & Pricing Notes: Old World "Traditional" Stile & Rail Profiles

Ordering Guidelines

1	Order Forms	Applicable order forms will include spaces to indicate your chosen profiles.
Pricing		
1	Pricing	Please see <i>Section E.3</i> of our current Wholesale Pricing Catalog .

Technical Notes: Old World "Traditional" Stile & Rail Profiles

Cabinet Door & Drawer Front Options (Chapter B)

1	Adventure Series	<input type="checkbox"/> AS = These profile options are available on Adventure series doors. See <i>Section B.7</i> for more information.
2	Gothic Door Styles 4100, 4200, 9100, 9200	Compatible with all Old World stile & rail profiles from <i>Section E.3</i> .

Convex/Concave Options (Chapter D)

1	Curved Products	The <input type="checkbox"/> C indicates profiles that are available for Convex/Concave products. For additional ordering guidelines, see <i>Chapter D</i> .
---	-----------------	--

Material Options

1	Material Options	<input type="checkbox"/> SW = Profile is available on products made from solid wood. <input type="checkbox"/> MDF = Profile is available on products made from MDF (Medium Density Fiberboard).
---	------------------	--

Profile Options (Chapter E)

1	Profile Drawings	All stile & rail and mullion stock drawings are full scale.
2	Mitered Stile & Rail Profiles	See <i>Section E.11</i> for Old World mitered stile & rail profiles.
3	Applied Molding Shelf	<input checked="" type="checkbox"/> This symbol indicates that a shelf applied molding can be used. See <i>Section E.4</i> for more information.
4	Center Panel Profile Options	The center panel profiles designed for use with Old World stile & rail profiles can be found in <i>Sections E.13</i> and <i>E.14</i> . • Old World stile & rail profiles from this section are not compatible with traditional center panel profiles from <i>Section E.12</i> . • See <i>page A.4.4</i> for typical construction of a 1" [25.4mm] thick Old World door.
5	Frame GRF Profiles	Frame GRF profiles will accept 1/8" [3.2mm] glass if using rubber retainer. To order, mark the box (X) for Frame Only or indicate the Mullion Lite Pattern (<i>ie: 2 x 3</i>) or LP Option (<i>ie: LP105</i>) in the box provided on your order form. For mullions, denote the # of Lites and whether they are Standard (S) or True Lite (TL). • True Lites are 2-piece construction.

Sizes/Dimensions

1	Thickness	Old World stile & rail profiles made from solid wood are available 1" [25.4mm], 1 1/8" [28.6mm] and 1 1/4" [31.8mm] thick. Old World stile & rail profiles made from raw MDF are only available 1" [25.4mm] thick. Old World stile & rail profiles made from raw MDF-MR are not available. Outside edge and stile & rail profile dimensions for 1 1/8" [28.6mm] and 1 1/4" [31.8mm] thicknesses are the same as those of our 1" [25.4mm] thick Old World door construction. • Additional thickness for the 1 1/8" [28.6mm] and 1 1/4" [31.8mm] Old World door construction is added to the back side of the stile & rail.
2	Standard Stile and Rail Dimensions and Non-Standard Parts	Old World stile and rail dimensions are 3" [76.2mm] wide. Stiles or rails that are greater or less than 3" [76.2mm] may be subject to Non-Standard part size charges. Please see <i>Section A.5</i> for more information on Non-Standard Part Sizes . The minimum width , at the narrowest point, for any top/bottom rail with or without a GRF cut is 1 1/4" [31.8mm]. The minimum width , at the narrowest point, for any outside stile, center stile or center rail with or without a GRF cut is 1 1/2" [38.1mm]. A 1 1/4" [44.5mm] minimum is required for hinge boring (<i>Section F.1</i>). The minimum distance for the flat surface between the stile and rail profile and the outside edge profile is 3/16" [4.8mm], this factor may also affect the minimum size required for hinge boring. Please refer to our website to reference the Stile & Rail Dimension and Outside Edge Profile charts to determine the minimum stile and rail size using this formula: Stile/Rail Profile Width + 3/16" [4.8mm] Flat Surface + Outside Edge Profile Width = Minimum Stile/Rail Width.
3	Minimum Length	The minimum visual length for a top or bottom rail and a center stile or rail is 2 1/2" [54mm].
4	Part Sizes	Stile and rail widths and lengths are determined by measuring across the back of the stiles and rails only.

Stile & Rail - Traditional Mortise & Tenon Joinery - Old World - END

► For PRICING ► See *Section E.3* in our current Wholesale Pricing Catalog.

Profile Options

Stile & Rail - Inside Edge Applied Molding

Inside Edge Applied Molding Applications with Matching Mullion Stock - 3/4" [19.3mm] Thick Doors

PC: AM101 Multiplier: .79 (#101)

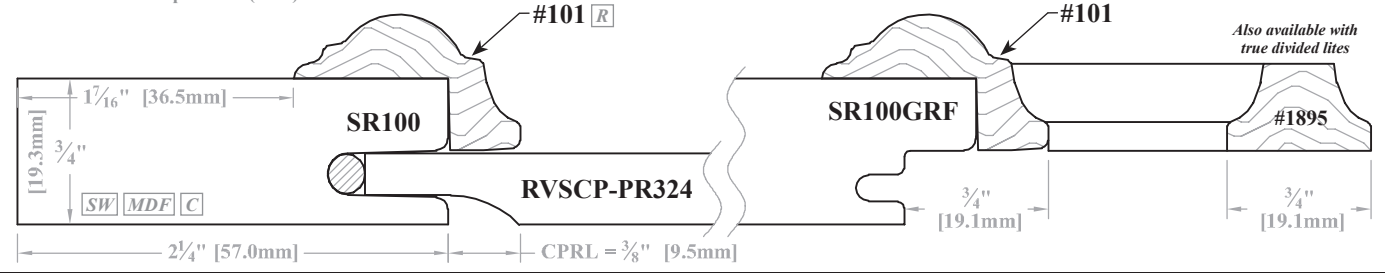

PC: AM101 Multiplier: .72 (#102)



PC: AM101 Multiplier: .83 (#1170)

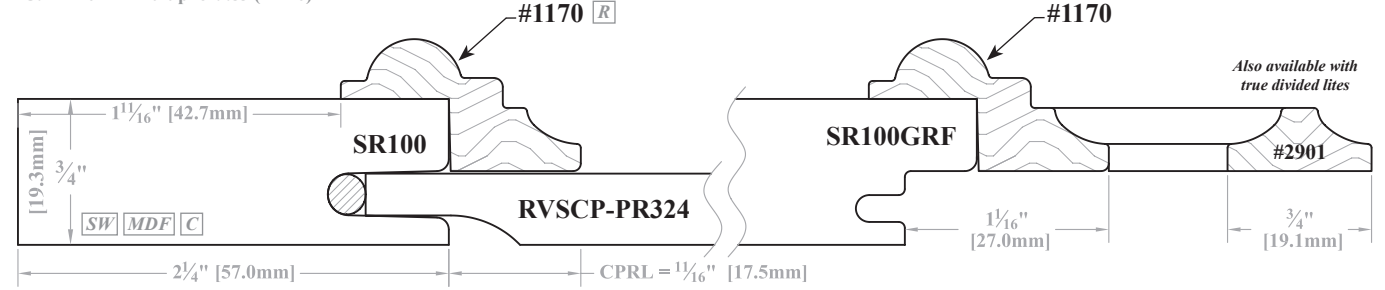

PC: AM101 Multiplier: .72 (#1205)

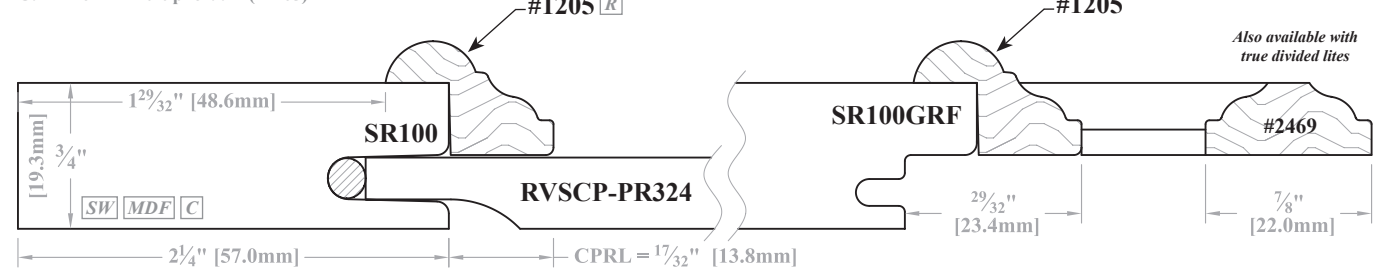

PC: AM101 Multiplier: .75 (#1148)

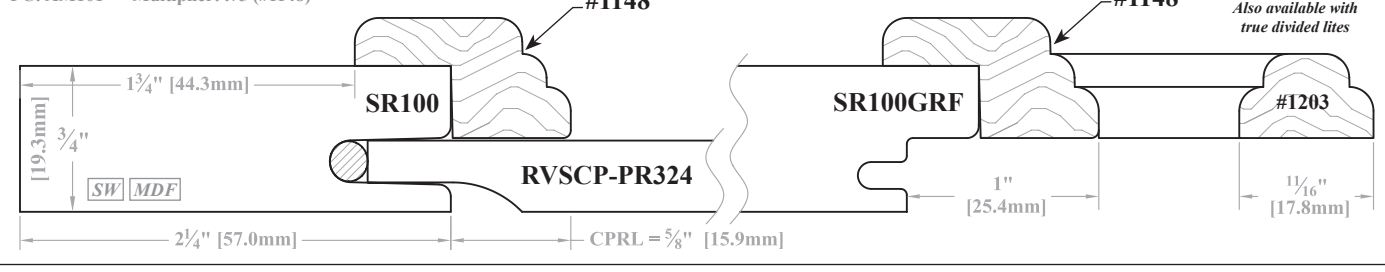

SW = Available in Solid Wood.

C = Stile/Rail & Applied Molding combo shown are available Convex/Concave

R = Available radiused to follow contour of shaped rails.

MDF = Stile / Rail profile available on 5-piece MDF doors. Applied molding will be solid wood.

► For PRICING ► See Section E.4 in our current Wholesale Pricing Catalog.

Inside Edge Applied Molding Applications with Matching Mullion Stock - 3/4" [19.3mm] Thick Doors

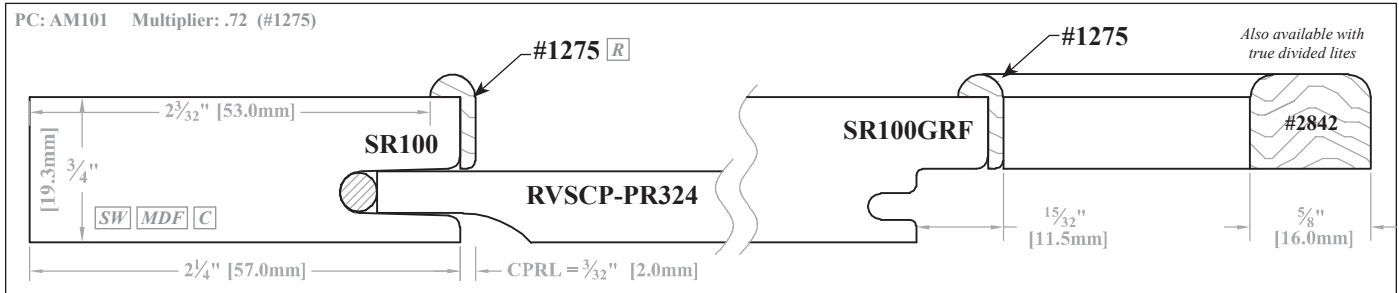
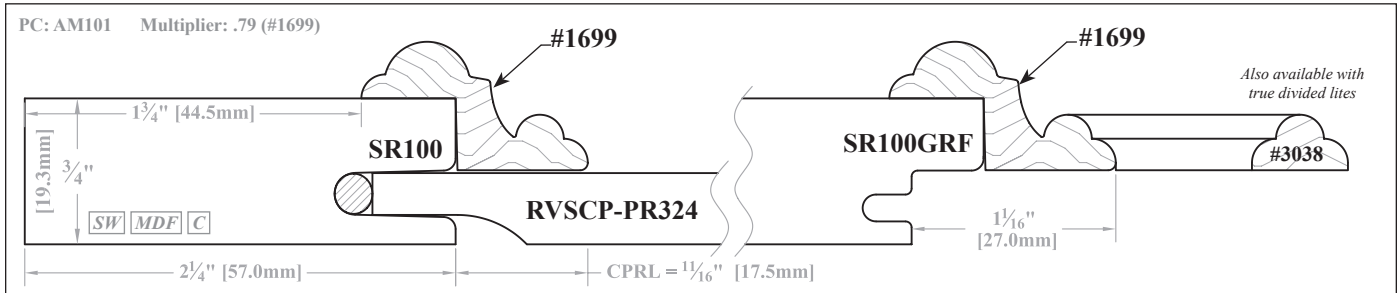
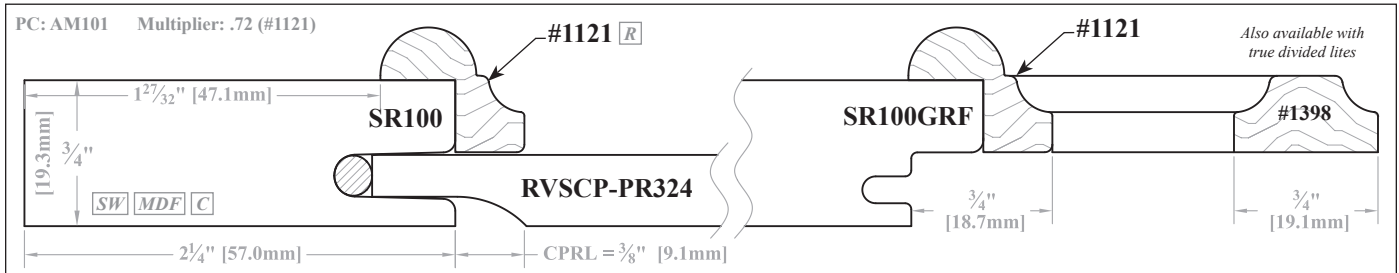
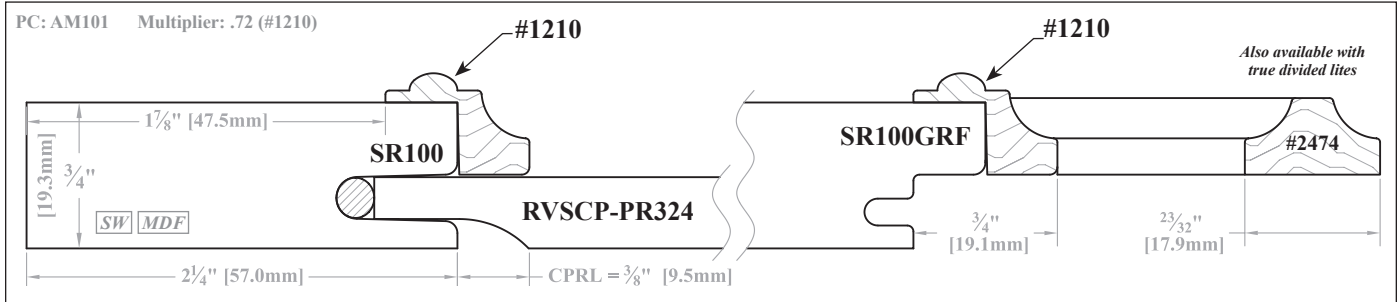
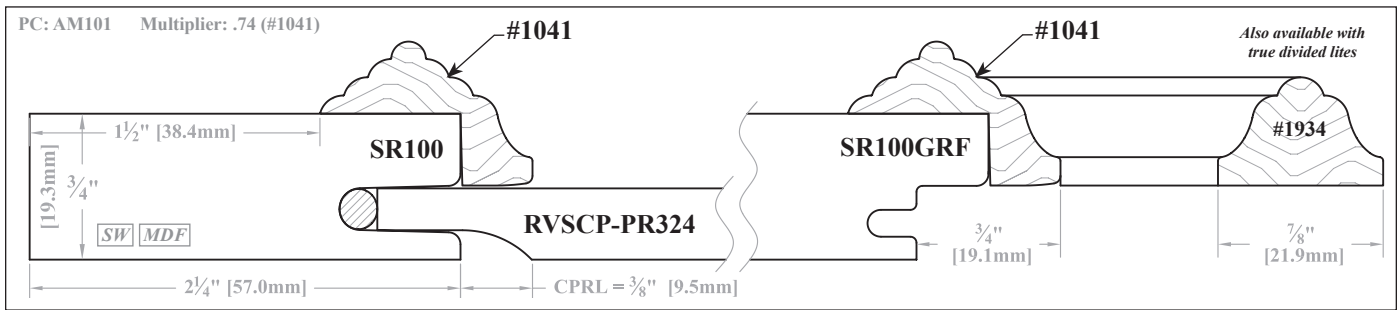

[SW] = Available in Solid Wood. [C] = Stile/Rail & Applied Molding combo shown are available Convex/Concave
 [R] = Available radiused to follow contour of shaped rails. [MDF] = Stile/Rail profile available on 5-piece MDF doors. Applied molding will be solid wood.

► For PRICING ► See Section E.4 in our current Wholesale Pricing Catalog.

Profile Options

Stile & Rail - Inside Edge Applied Molding

Inside Edge Applied Molding Applications with Matching Mullion Stock - $\frac{3}{4}$ " [19.3mm] Thick Doors

PC: AM101 Multiplier: .72 (#1276)

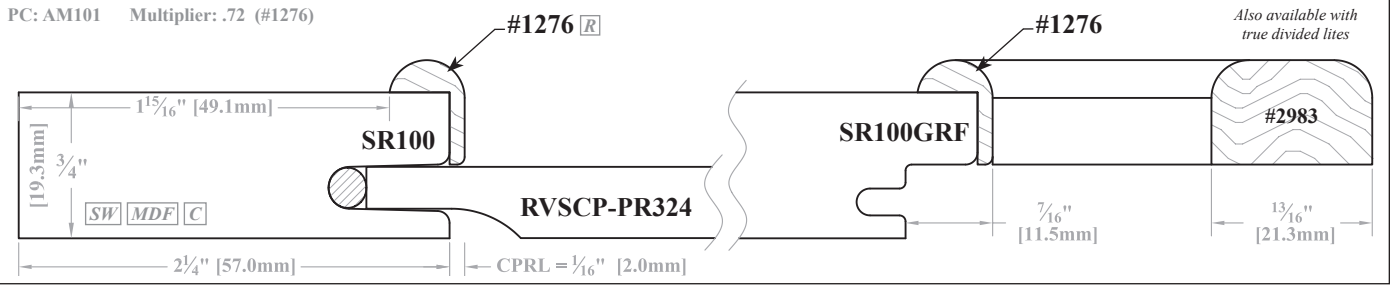

PC: AM101 Multiplier: .72 (#2054)

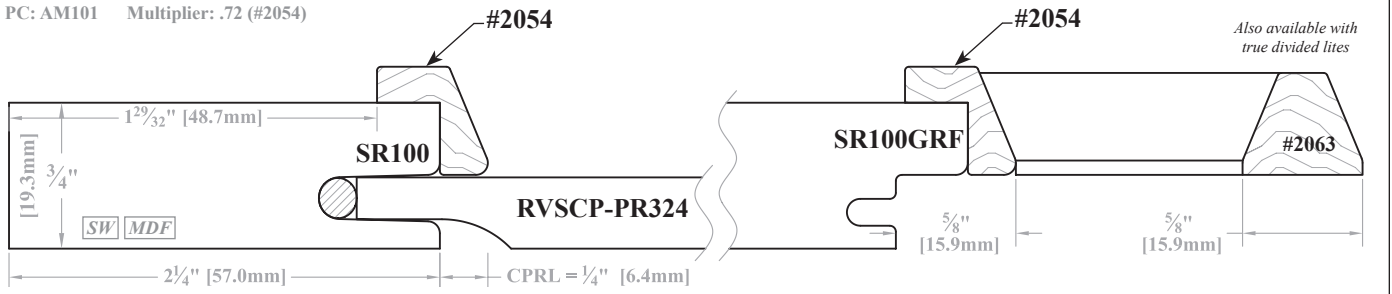

PC: AM101 Multiplier: .72 (#2056)



PC: AM101 Multiplier: .72 (#2057)

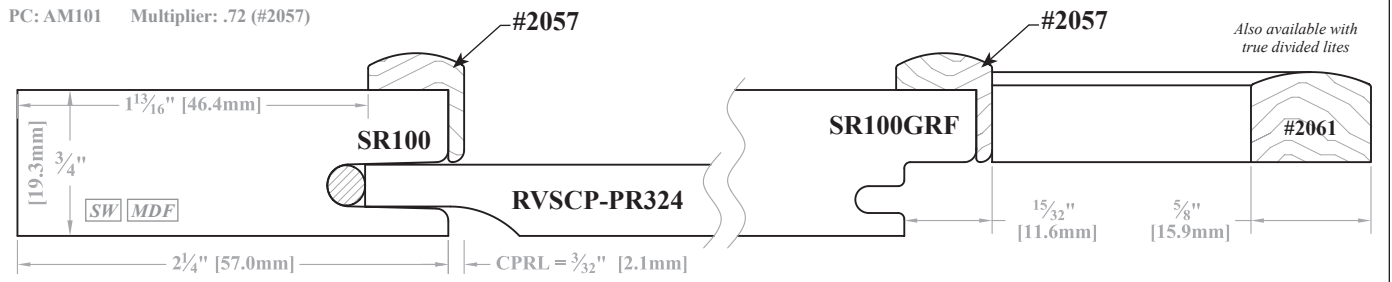

PC: AM101 Multiplier: 1.06 (#1716 - GRF Extension Molding)

PC: AM101 Multiplier: 1.00 (#2308)

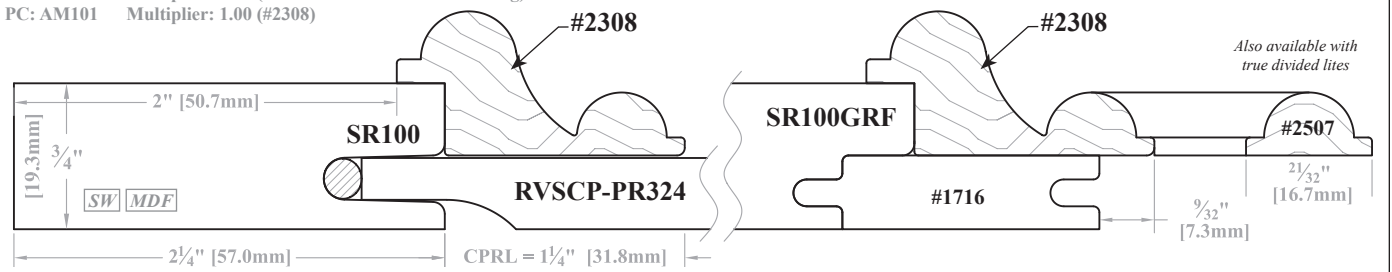

[SW] = Available in Solid Wood.

[C] = Stile/Rail & Applied Molding combo shown are available Convex/Concave

[R] = Available radiused to follow contour of shaped rails.

[MDF] = Stile/Rail profile available on 5-piece MDF doors. Applied molding will be solid wood.

► For PRICING ► See Section E.4 in our current Wholesale Pricing Catalog.

Inside Edge Applied Molding Applications with Matching Mullion Stock - 3/4" [19.3mm] Thick Doors

PC: AM101 Multiplier: .72 (#2451)

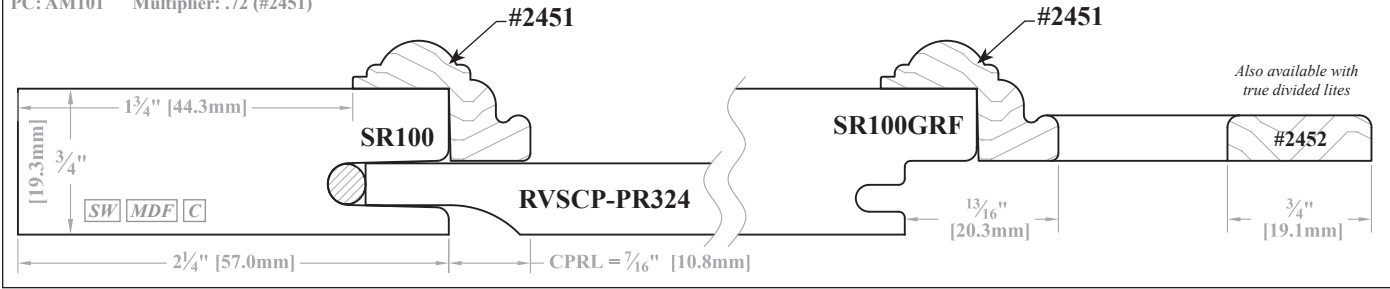

PC: AM101 Multiplier: .72 (#2508)

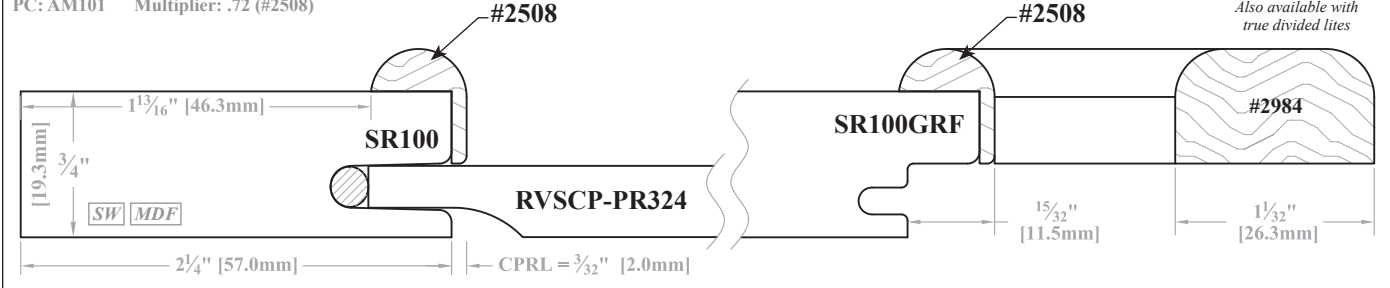

PC: AM101 Multiplier: 1.23 (#2565)

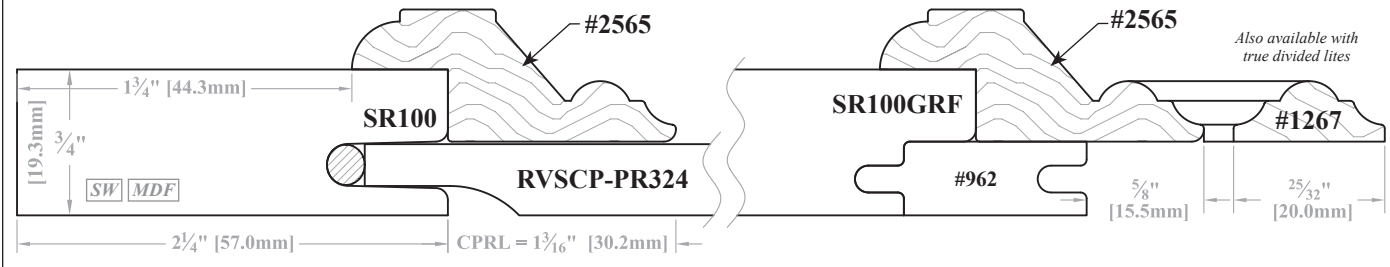

PC: AM101 Multiplier: .72 (#2932)

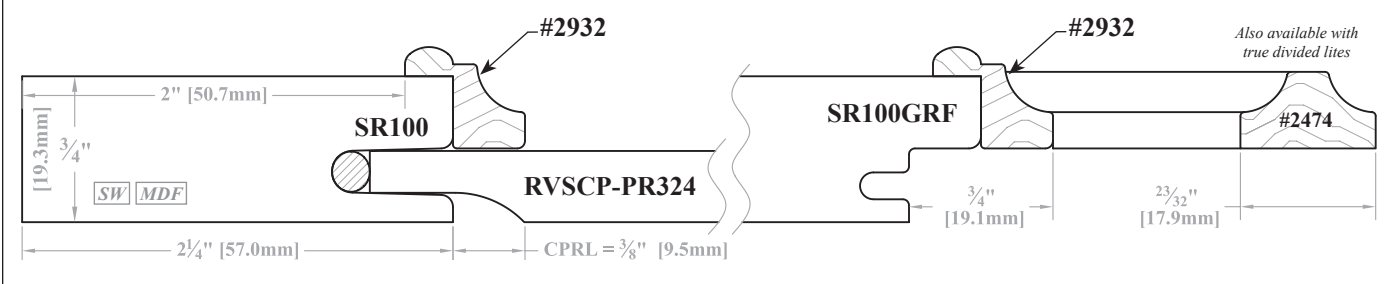

SW = Available in Solid Wood.

C = Stile/Rail & Applied Molding combo shown are available Convex/Concave

R = Available radiused to follow contour of shaped rails.

MDF = Stile/Rail profile available on 5-piece MDF doors. Applied molding will be solid wood.

► For PRICING ► See Section E.4 in our current Wholesale Pricing Catalog.

Profile Options

Stile & Rail - Inside Edge Applied Molding

Inside Edge Applied Molding Applications with Matching Mullion Stock - 3/4" [19.3mm] Thick Doors

PC: AM101 Multiplier: .72 (#1112)

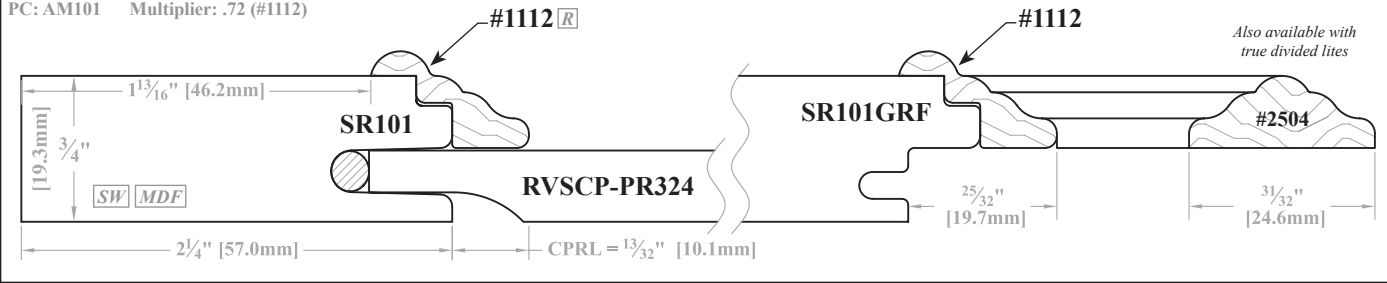

PC: AM101 Multiplier: .72 (#1252)

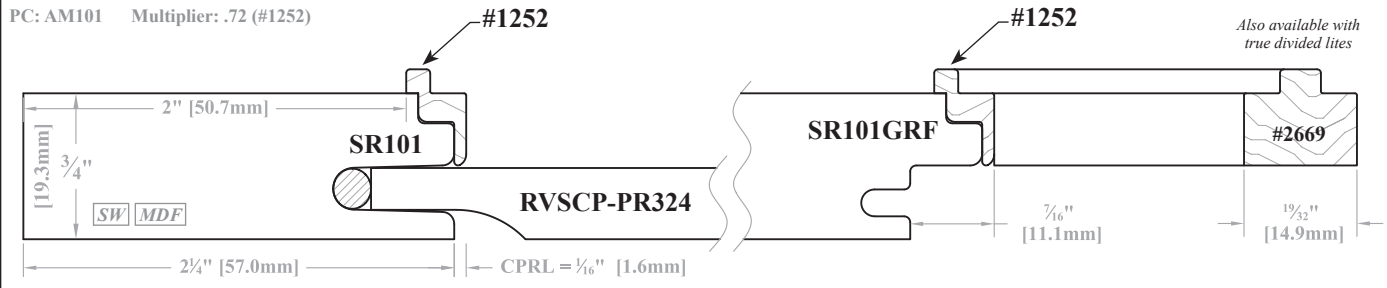

PC: AM101 Multiplier: .72 (#1126)

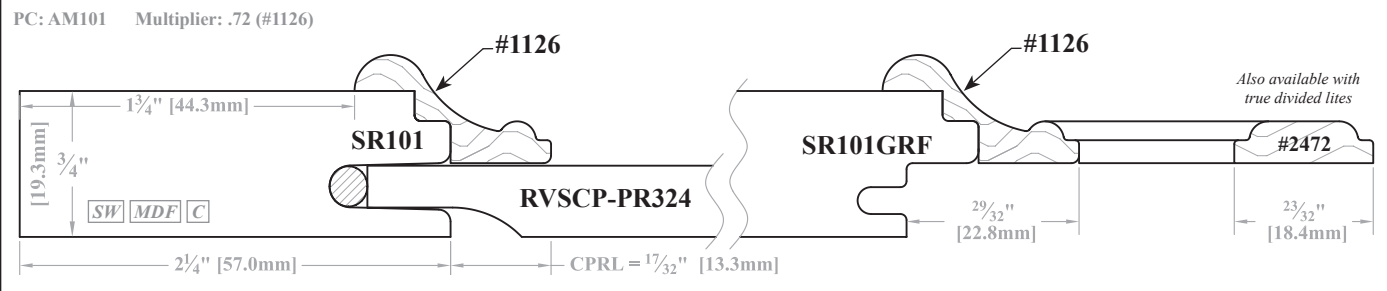

PC: AM101 Multiplier: .72 (#1088)

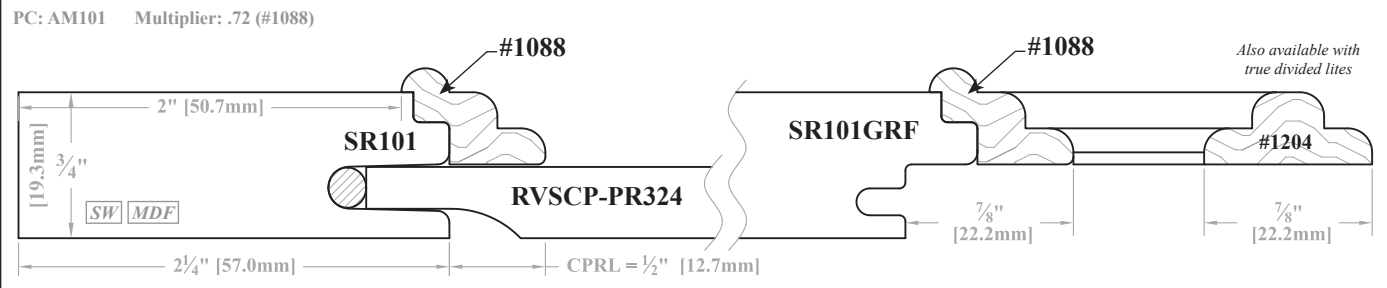

PC: AM101 Multiplier: .72 (#1144)

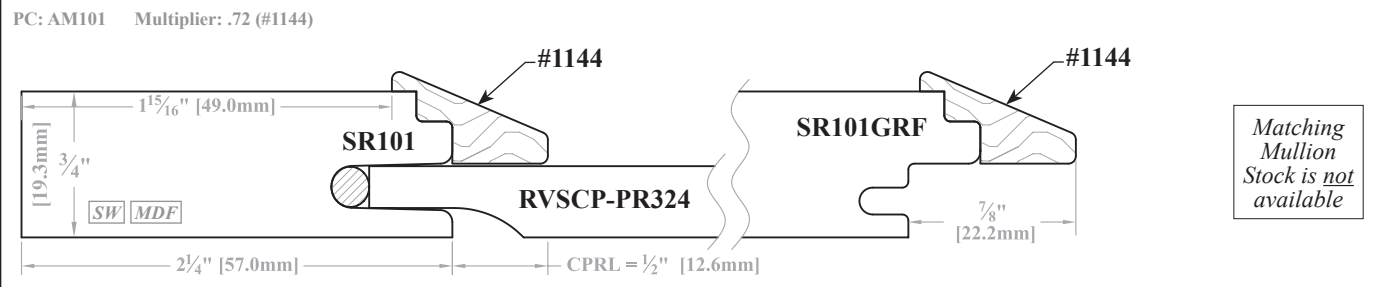

SW = Available in Solid Wood.

C = Stile/Rail & Applied Molding combo shown are available Convex/Concave

R = Available radiused to follow contour of shaped rails.

MDF = Stile/Rail profile available on 5-piece MDF doors. Applied molding will be solid wood.

► For PRICING ► See Section E.4 in our current Wholesale Pricing Catalog.

Inside Edge Applied Molding Applications with Matching Mullion Stock - 3/4" [19.3mm] Thick Doors

PC: AM101 Multiplier: .72 (#1809)

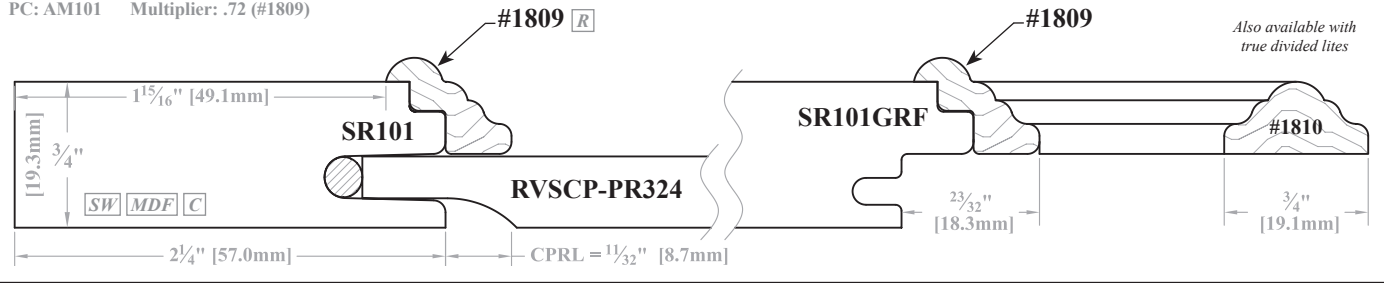

PC: AM101 Multiplier: .72 (#387)

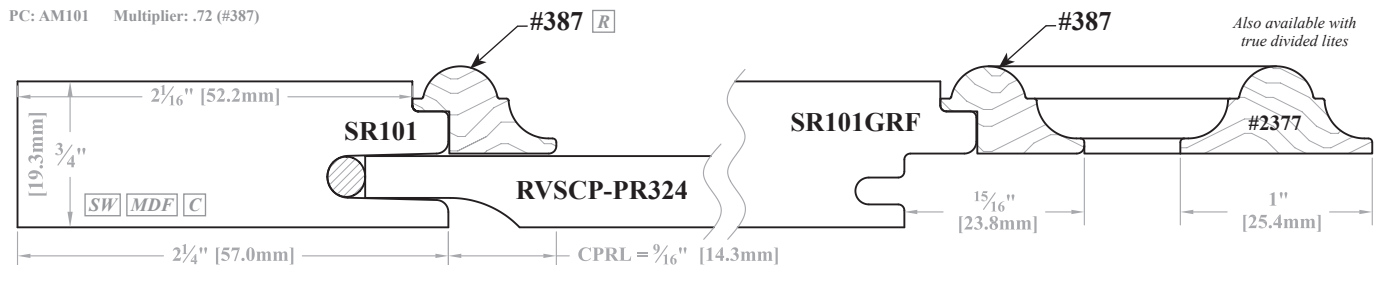

PC: AM101 Multiplier: .72 (#890)

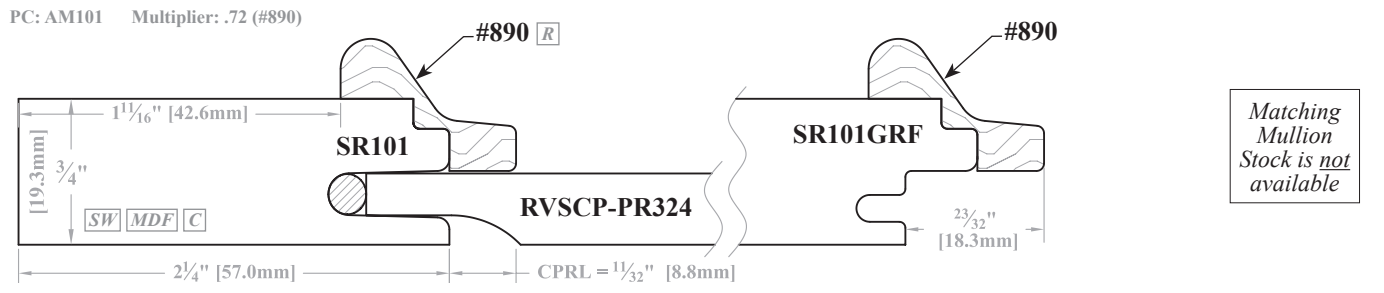

PC: AM101 Multiplier: .72 (#945)



PC: AM101 Multiplier: .72 (#987)

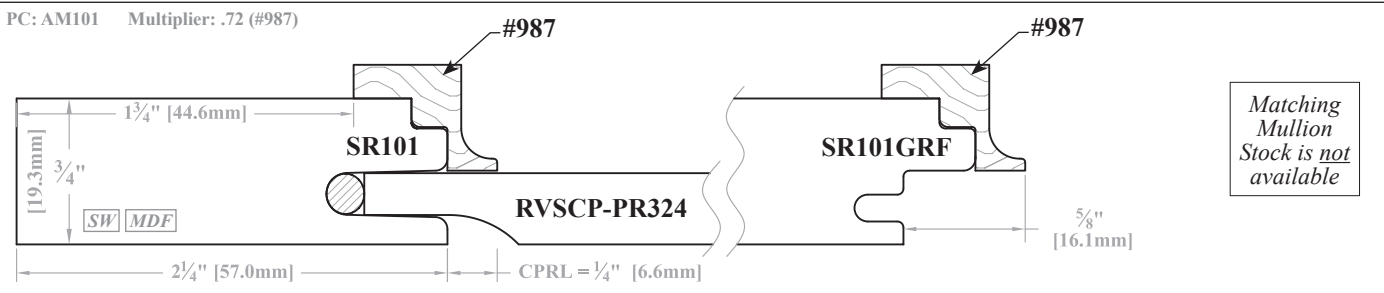

[SW] = Available in Solid Wood.

[C] = Stile/Rail & Applied Molding combo shown are available Convex/Concave

[R] = Available radiused to follow contour of shaped rails.

[MDF] = Stile/Rail profile available on 5-piece MDF doors. Applied molding will be solid wood.

► For PRICING ► See Section E.4 in our current Wholesale Pricing Catalog.

Profile Options

Stile & Rail - Inside Edge Applied Molding

Inside Edge Applied Molding Applications with Matching Mullion Stock - 3/4" [19.3mm] Thick Doors

PC: AM102 Multiplier: .72 (#1174)

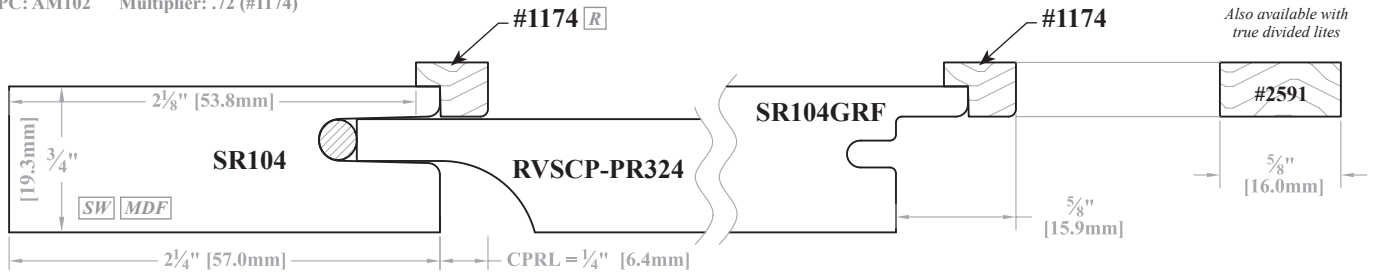

PC: AM101 Multiplier: .72 (#1175)

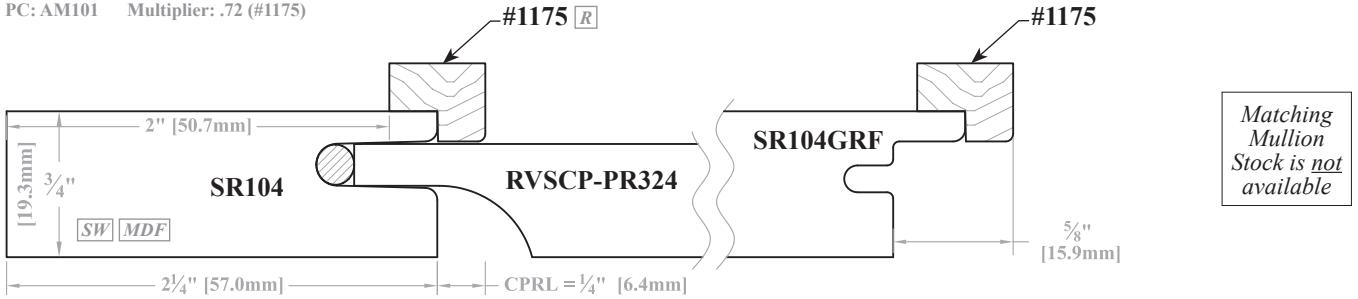

PC: AM102 Multiplier: .72 (#1690)



PC: AM101 Multiplier: .72 (#1681)

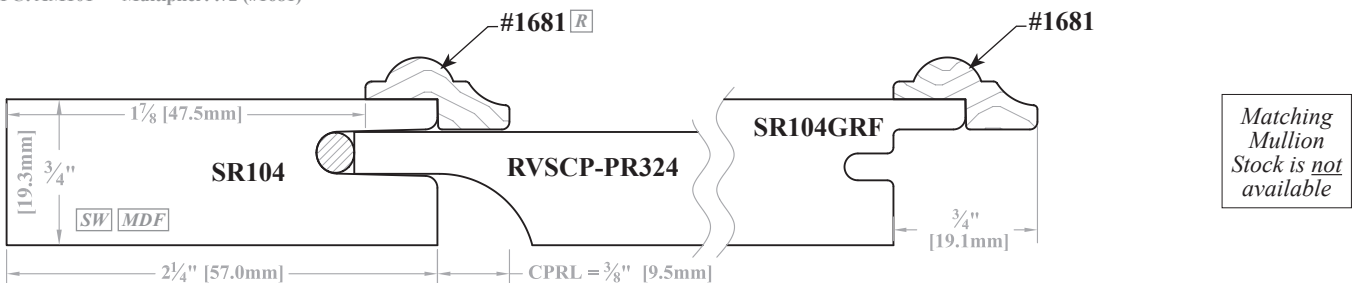

PC: AM101 Multiplier: 1.16 (#1634)
PC: AM101 Multiplier: .80 (#1136 - GRF Extension Molding)

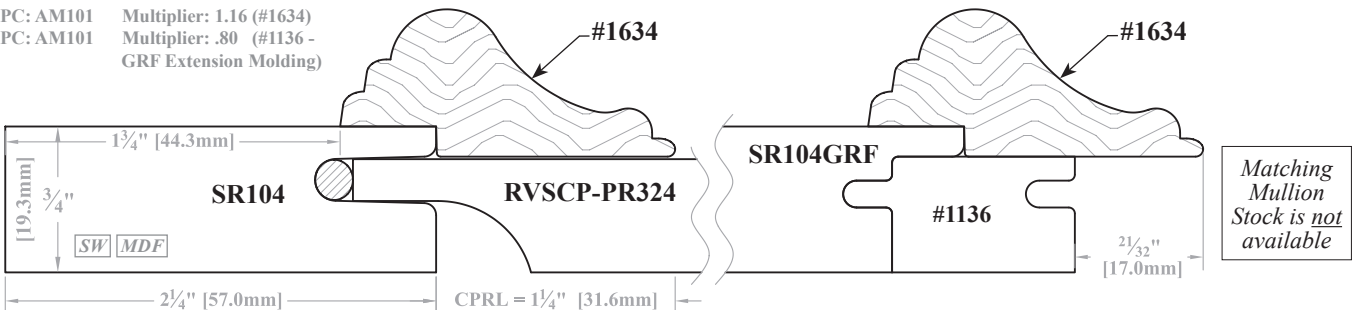

[SW] = Available in Solid Wood. [C] = Stile/Rail & Applied Molding combo shown are available Convex/Concave
[R] = Available radiused to follow contour of shaped rails. [MDF] = Stile/Rail profile available on 5-piece MDF doors. Applied molding will be solid wood.

► For PRICING ► See Section E.4 in our current Wholesale Pricing Catalog.

Inside Edge Applied Molding Applications with Matching Mullion Stock - 3/4" [19.3mm] Thick Doors

PC: AM101 Multiplier: .72 (#1685)

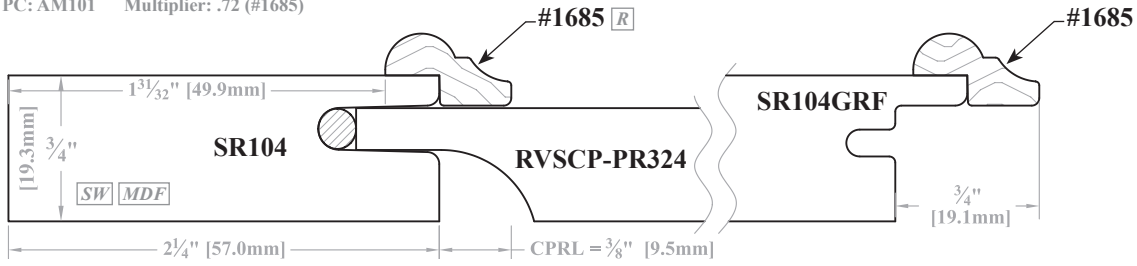

PC: AM102 Multiplier: .72 (#1913)

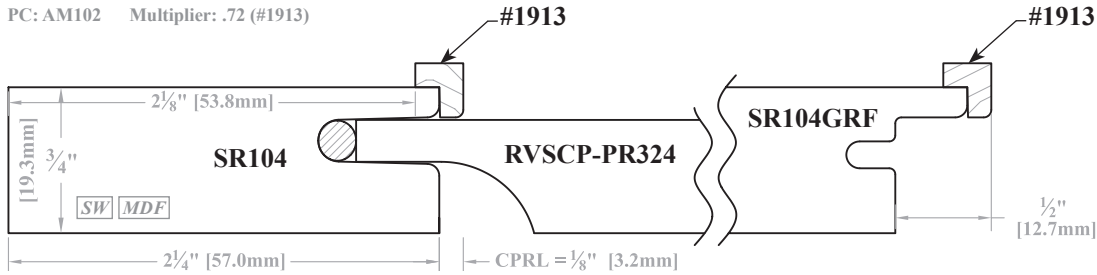

PC: AM101 Multiplier: .75 (#2449)

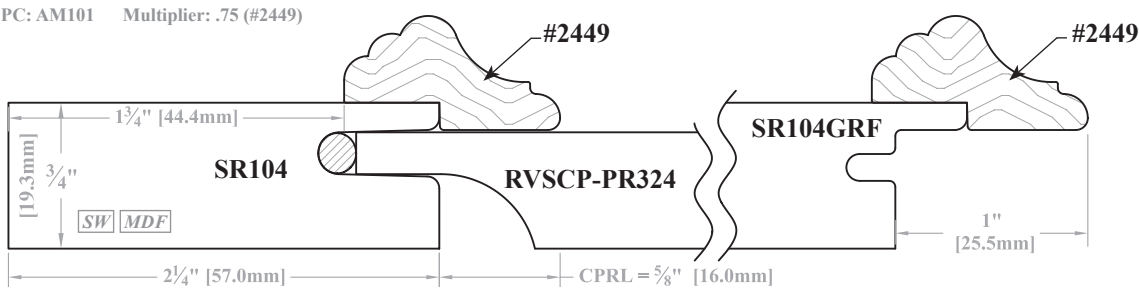

PC: AM101 Multiplier: .72 (#3126)

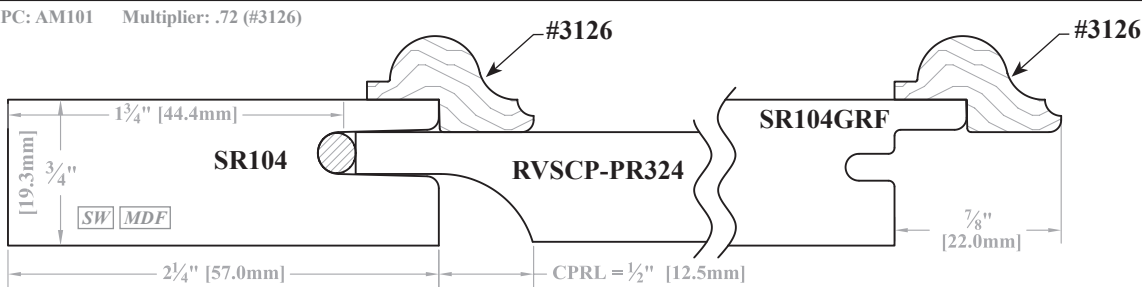

PC: AM101 Multiplier: .83 (#2492)

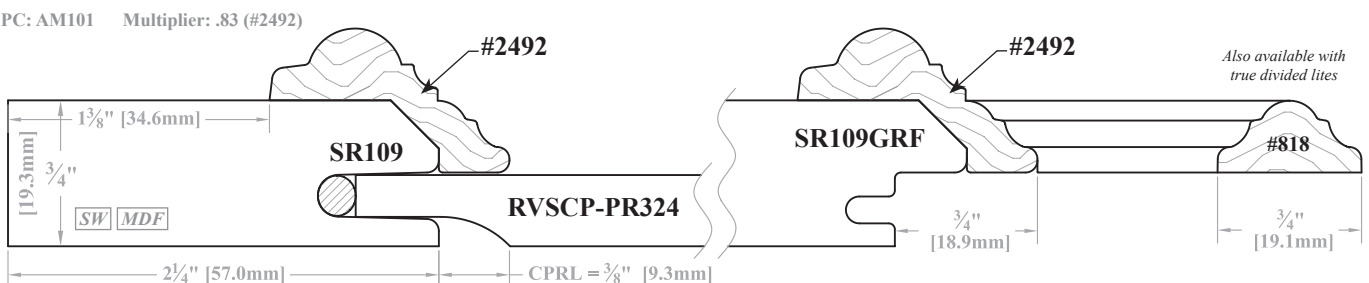

[SW] = Available in Solid Wood.

[C] = Stile/Rail & Applied Molding combo shown are available Convex/Concave

[R] = Available radiused to follow contour of shaped rails.

[MDF] = Stile/Rail profile available on 5-piece MDF doors. Applied molding will be solid wood.

► For PRICING ► See Section E.4 in our current Wholesale Pricing Catalog.

Profile Options

Stile & Rail - Inside Edge Applied Molding

Inside Edge Applied Molding Applications with Matching Mullion Stock - 3/4" [19.3mm] Thick Doors

PC: AM101 Multiplier: .72 (#1734)

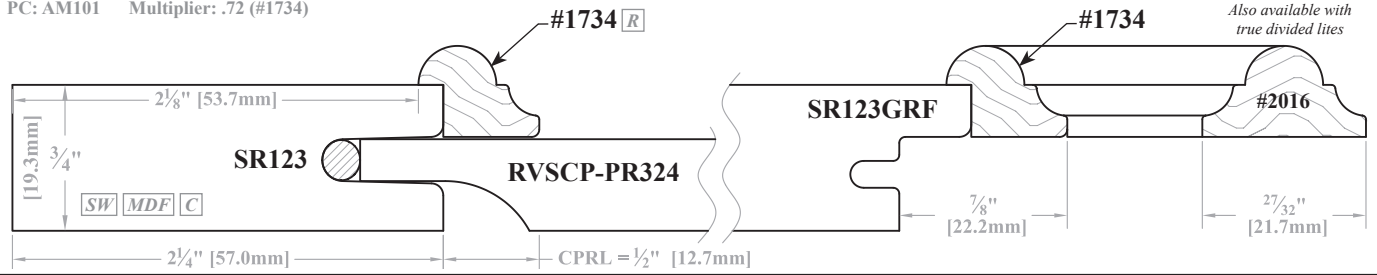

PC: AM101 Multiplier: .72 (#1777)

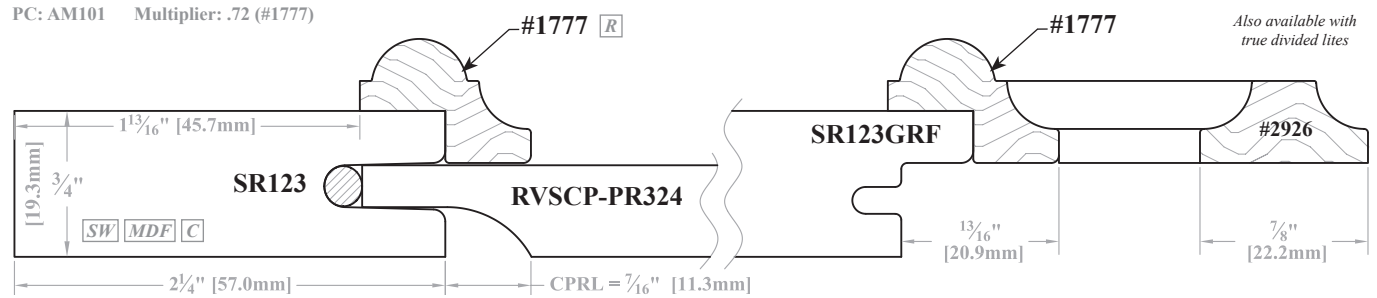

PC: AM101 Multiplier: .74 (#1927)

PC: AM101 Multiplier: .81 (#2924 - GRF Extension Molding)

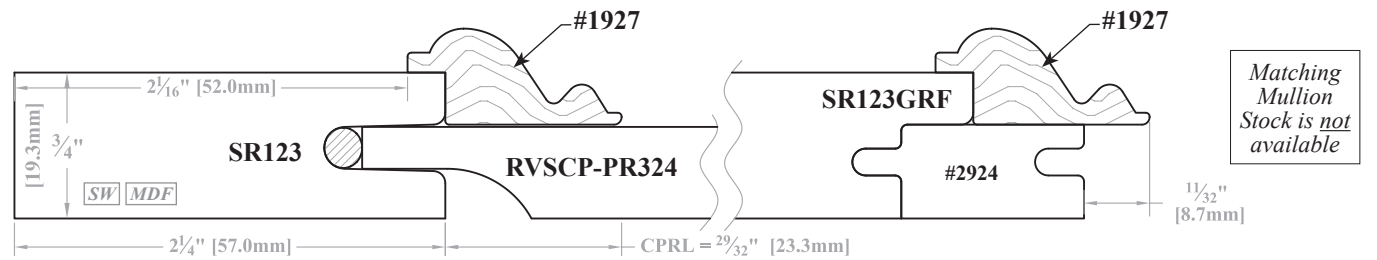

PC: AM101 Multiplier: .72 (#1907)

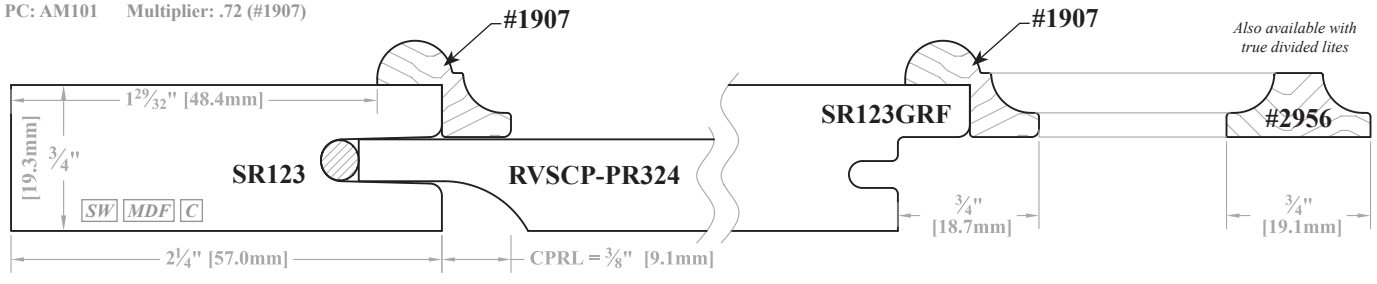

PC: AM101 Multiplier: .72 (#1970)

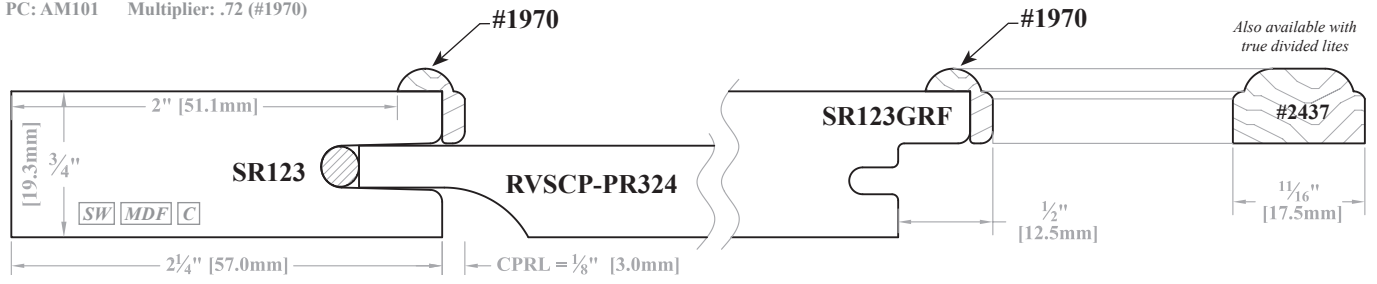

SW = Available in Solid Wood.

C = Stile/Rail & Applied Molding combo shown are available Convex/Concave

R = Available radiused to follow contour of shaped rails.

MDF = Stile/Rail profile available on 5-piece MDF doors. Applied molding will be solid wood.

► For PRICING ► See Section E.4 in our current Wholesale Pricing Catalog.

Stile & Rail - Inside Edge Applied Molding

Profile Options

Inside Edge Applied Molding Applications with Matching Mullion Stock - 3/4" [19.3mm] Thick Doors

PC: AM101 Multiplier: .72 (#2007)

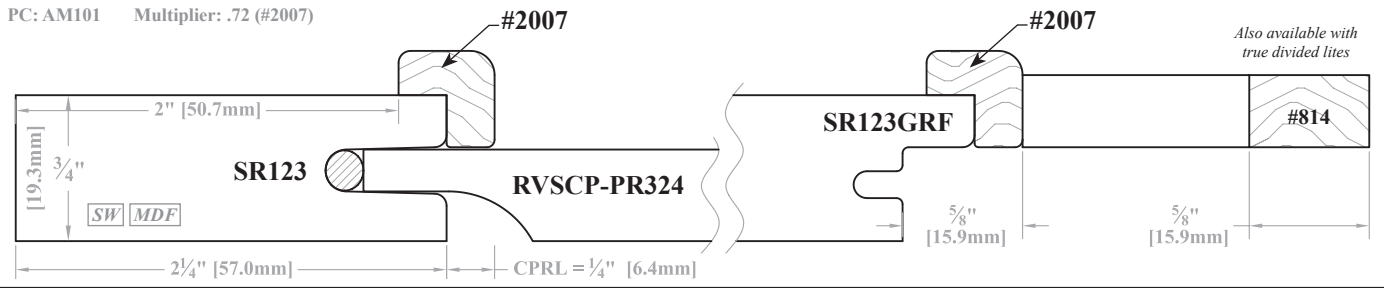

PC: AM102 Multiplier: .72 (#2091)

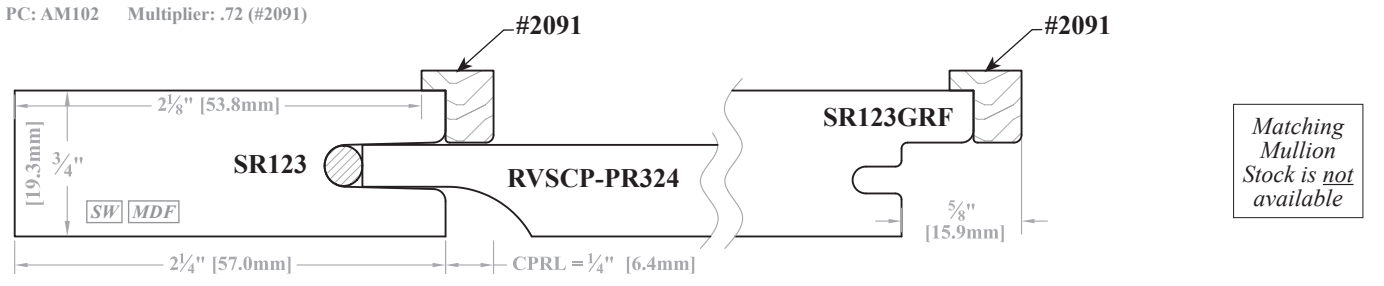

PC: AM101 Multiplier: .72 (#2213)

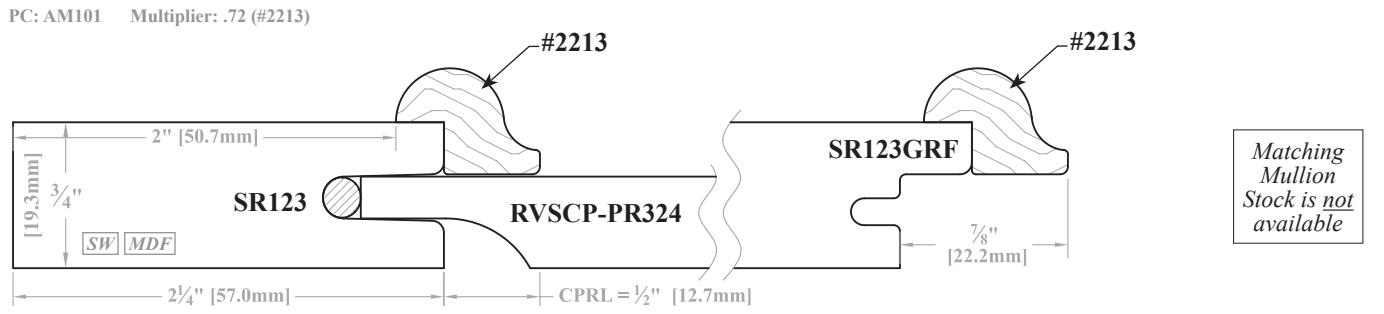

PC: AM101 Multiplier: .72 (#2286)

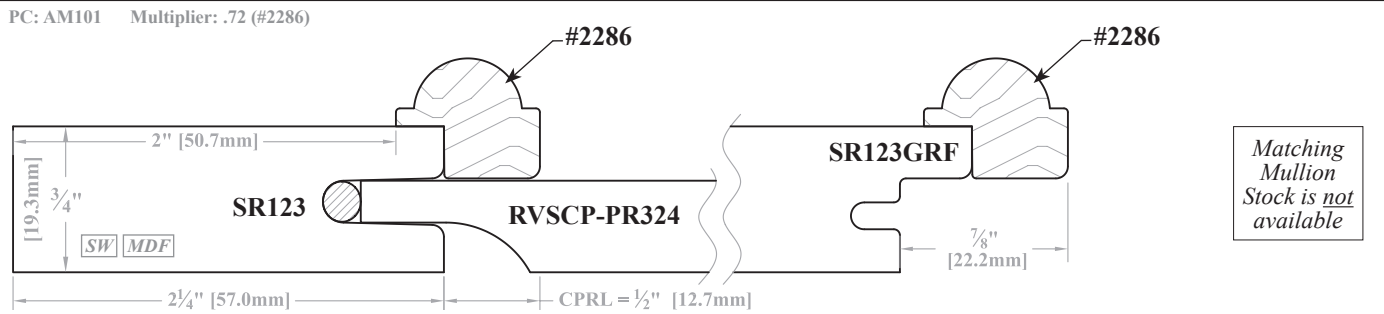

PC: AM101 Multiplier: .72 (#2596)

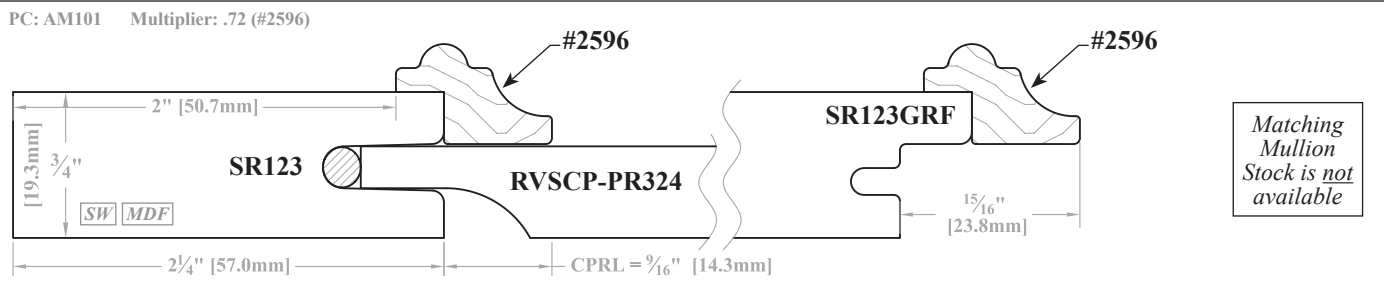

[SW] = Available in Solid Wood.

[C] = Stile/Rail & Applied Molding combo shown are available Convex/Concave

[R] = Available radiused to follow contour of shaped rails.

[MDF] = Stile/Rail profile available on 5-piece MDF doors. Applied molding will be solid wood.

► For PRICING ► See Section E.4 in our current Wholesale Pricing Catalog.

Profile Options

Stile & Rail - Inside Edge Applied Molding

Inside Edge Applied Molding Applications with Matching Mullion Stock - 3/4" [19.3mm] Thick Doors

PC: AM101 Multiplier: .72 (#2597)

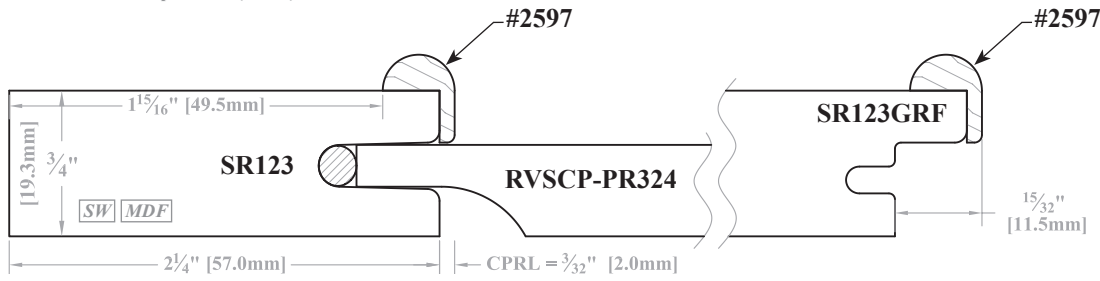

Matching Mullion Stock is not available

E

SW = Available in Solid Wood. **C** = Stile/Rail & Applied Molding combo shown are available Convex/Concave
R = Available radiused to follow contour of shaped rails. **MDF** = Stile/Rail profile available on 5-piece MDF doors. Applied molding will be solid wood.

► For PRICING ► See Section E.4 in our current Wholesale Pricing Catalog.

Inside Edge Applied Molding Applications with Matching Mullion Stock - 1" [25.4mm] Thick "Old World" Doors

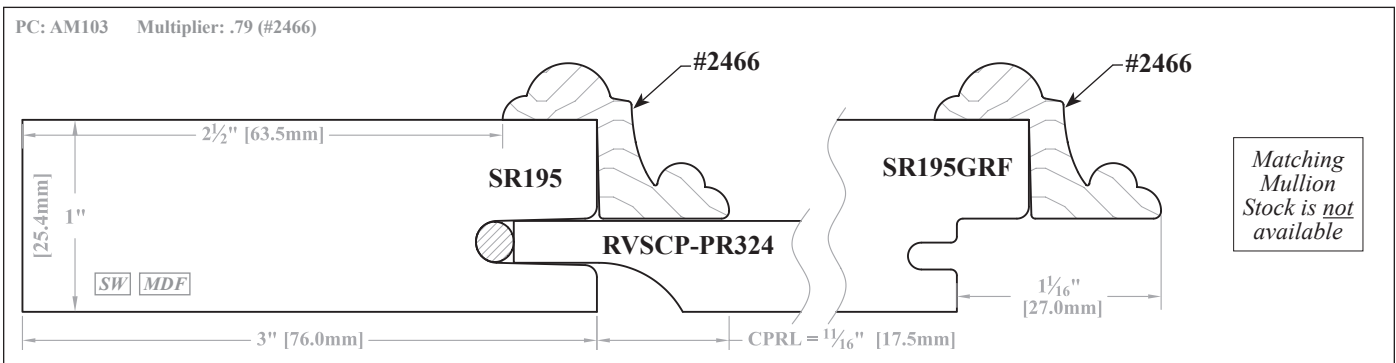
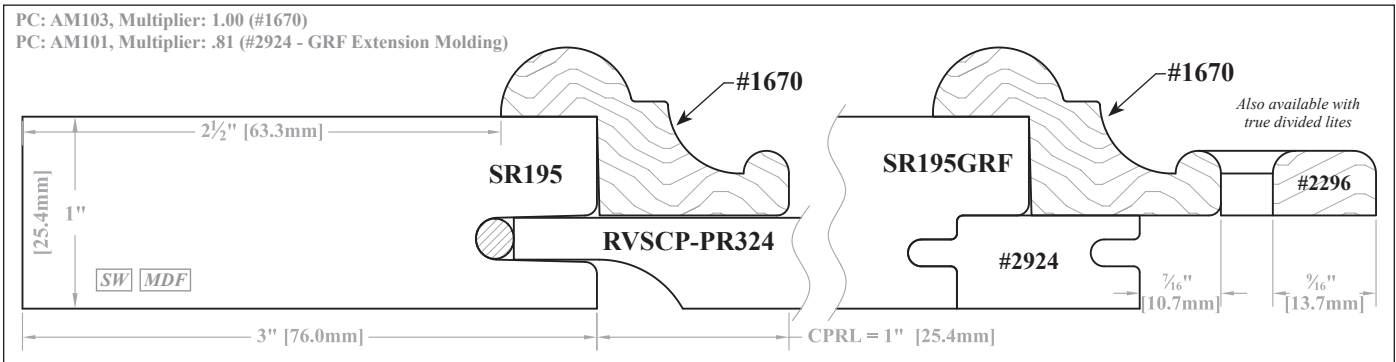
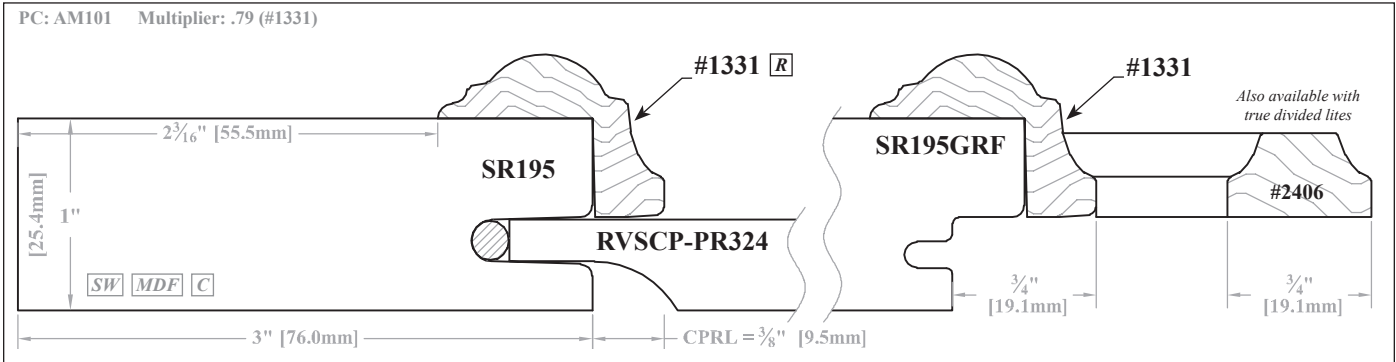
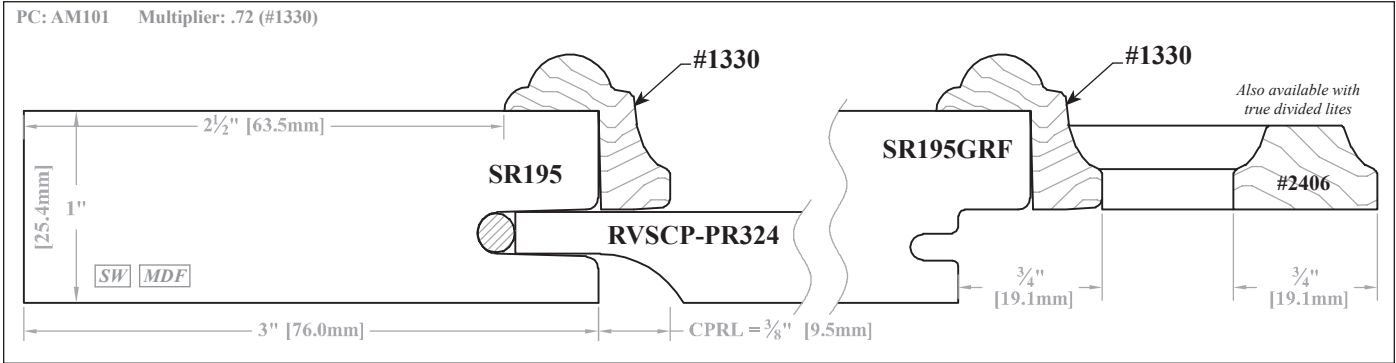

SW = Available in Solid Wood. C = Stile/Rail & Applied Molding combo shown are available Convex/Concave
R = Available radiused to follow contour of shaped rails. MDF = Stile/Rail profile available on 5-piece MDF doors. Applied molding will be solid wood.

► **For PRICING** ► See Section E.4 in our current Wholesale Pricing Catalog.

Ordering & Pricing Notes: Inside Edge Applied Molding Stile/Rail Profiles

Ordering Guidelines

1	Order Forms	Applicable order forms will include spaces to indicate your chosen profiles.
Pricing		
1	Pricing	Please see <i>Section E.4</i> and <i>E.8</i> of our current Wholesale Pricing Catalog .

Technical Notes: Inside Edge Applied Molding Stile/Rail Profiles

Cabinet Door & Drawer Front Options (Chapter B)

1	Doors w/ Square Rails	Raised or flat panel square doors, frames or wainscot panels using Traditional or Mitered stile and rail joinery are available with applied moldings.
2	Doors w/ Angled Stiles or Rails	Raised or flat panel angled doors, frames or wainscot panels using Traditional stile and rail joinery are available with applied moldings. Door Price Classes: 122, 126, 139, 140, 222, 226, 239, 240.
3	Doors w/ Shaped Rails	Raised or flat panel doors, frames or wainscot panels with one or more shaped rail, as well as quarter circle, half circle and Gothic doors and frames are available with applied moldings that follow the contour of the shaped rails. Not all applied moldings are available, please refer to <i>Molding Options</i> notes within this section. Some door styles may require additional customization which may be subject to additional design charges.

Convex/Concave Options (Chapter D)

1	Curved Products	[C] = Indicates that the stile/rail profile and applied molding and/or GRF extension molding combinations shown are available for Convex/Concave applications. See <i>Chapter D</i> for more information on Convex/Concave products.
---	-----------------	---

General Information (Chapter A)

1	Ready to Assemble (RTA)	Doors and drawer fronts with applied molding are not available Ready to Assemble (RTA).
---	-------------------------	---

Material Options

1	Material Options	[SW] = Stile & rail profile available on products made from solid wood. [MDF] = Stile & rail profile available on 5-piece MDF doors. Applied molding will be solid wood.
---	------------------	---

Miscellaneous

1	Application Method	Most applied moldings are glued and press fit. Small headless pins may be necessary for some applications. If used, these tiny pin holes will not be filled with putty.
---	--------------------	--

Molding Options (Chapter N)

1	GRF Extension Moldings	Some applied moldings require an additional GRF extension molding when frame & mullion doors are ordered. For door styles with a shaped rail or rails (ie: style 2000), the rail will be routed to follow the contour of the shape, thereby requiring the glass to be cut to follow the contour of the shape also.
2	Radius Molding	[R] = Indicates applied moldings, mullion stock moldings (when used as applied moldings) and GRF extension moldings can be radiused to follow the contour of a shaped rail (ie: arched top rail of door style 2000). Note, these options are not to be confused with options available for lite patterns. Stile & rail profile/mullion stock availability for lite pattern options can be found on our website.
3	Multiple Applied Moldings	You may use more than one applied molding on a door or drawer front. Each applied molding would be priced using the lineal inch price for that molding, in addition to joint charges for each molding. Contact our Customer Support Team for questions.

Profile Options (Chapter E)

1	Compatibility	See our website , Resources/Technical Information for Applied Molding/Centers Panel Compatibility charts to ensure that the molding and panel profile you have selected are compatible. When using a veneered flat or RVSCP-PR324 (Reversed Solid Center Panel) , we suggest allowing 1" [25.4mm] of visible flat surface on the center panel to allow for attaching hardware. See our website , Resources/Technical Information for Applied Molding S/R & Mitered Profile Compatibility charts.
---	---------------	--

Continued on next page...

► For **PRICING** ► See *Section E.4* in our current Wholesale Pricing Catalog.

Technical Notes: Inside Edge Applied Molding Stile/Rail Profiles...continued

Sizes/Dimensions

1	Application Drawings	The application drawings shown throughout <i>Sections E.4, E.5 and E.6</i> can utilize either Traditional or Old World joinery. Traditional stile & rail profiles are standard at 2¼" [57.2mm] wide and Old World are standard at 3" [76.2mm] wide. Drawings are shown at full scale.
		The dimension on the face after the molding is applied will vary, depending on the outside edge profile that is selected.
2	Applied Molding on Center Stiles and/or Center Rails	When ordering an applied molding profile on a door stile with a center stile or center rail, the amount of visible flat space on the center stile & rail will be less than that of the outside stile & rail, given that the applied molding would be affixed to both sides of the center stile & rail. WalzCraft does not automatically modify the width of the center stile & rail to compensate for this.

Wood Specie Options (Chapter S)

1	Wood Species and Grade	When ordering applied moldings, the applied molding will match the wood species and grade of the door unless otherwise noted. Wood species may be limited. See <i>Section E.8</i> in our current Wholesale Pricing Catalog for availability. If an applied molding is Quarter Sawn, Rift Sawn (Straight Grain) or (Straight Grain), WalzCraft will attempt to match the grain on the face of the molding to the grain on the face of the product (ie: door or drawer front). However, it should be expected that Quarter Sawn grain will have some amount of Rift Sawn character, and Rift Sawn grain will have some amount of Quarter Sawn character. This is especially true when moldings have deep profiles.
2	MDF Stiles/Rails with Solid Wood Applied Molding	When stiles/rails are MDF, the applied molding will be made from one of the following: • Maple-Hard/Soft-Mixed-Value/Budget/Paint Grade • Birch-Value/Budget/Paint Grade • Poplar-Value/Budget/Paint Grade.

Center Panel Reveal Loss (CPRL)

When placing an applied molding on a door with a raised center panel, WalzCraft will not automatically adjust the center panel reveal.

- You must factor in the Center Panel Reveal Loss (CPRL) and plan accordingly.
- See examples below of how the center panel reveal is affected when adding an applied molding.

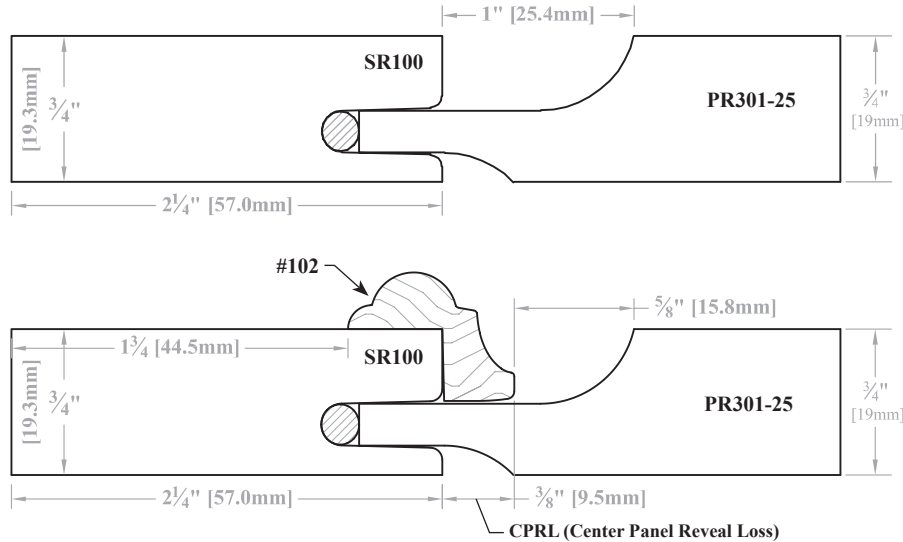

1" Center Panel Reveal (PR301-25) less 3/8" Center Panel Reveal Loss (CPRL) from applied molding #102 = 5/8".

Stile & Rail - Inside Edge Applied Molding - END

► For PRICING ► See Section E.4 in our current Wholesale Pricing Catalog.

Shelf Applied Molding Applications with Matching Mullion Stock - 3/4" [19.3mm] Thick Doors

Molding #1356 is an Embossed Beaded Molding.
See Outsourced Applied Moldings for Top View, Wood Species Options and Pricing.

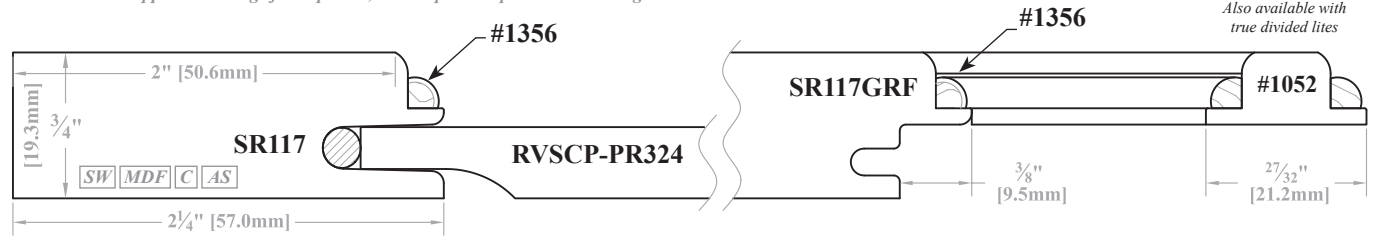

PC: AM102 Multiplier: .72 (#1721)

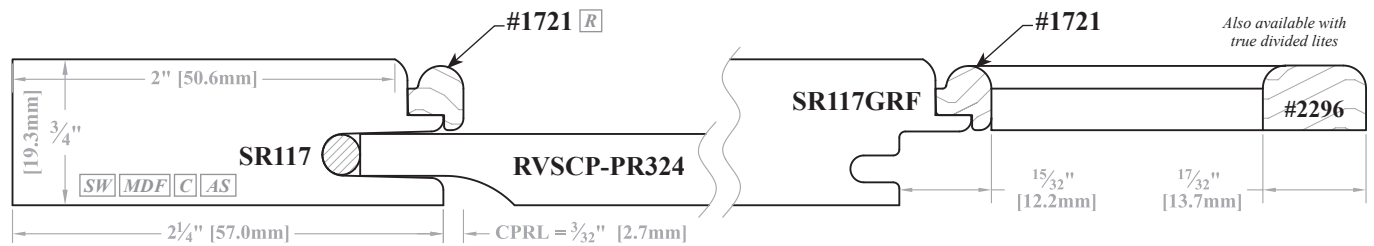

PC: AM102 Multiplier: .72 (#1861)

* Applied Molding #1861 is not available with Shaped Rails or Curved Products.

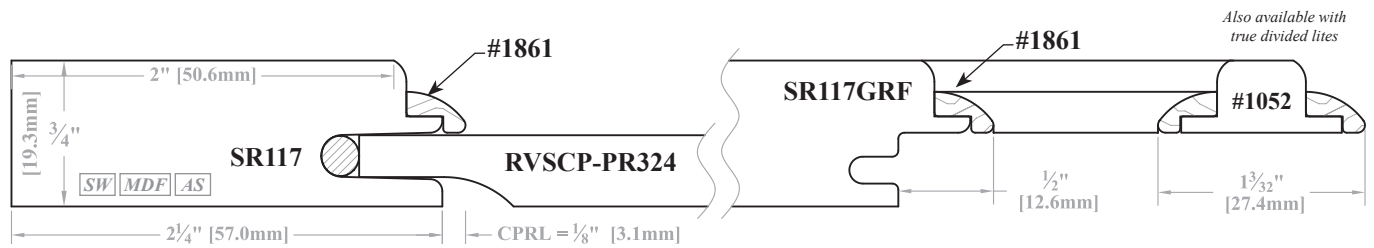

PC: AM101 Multiplier: .72 (#1722)

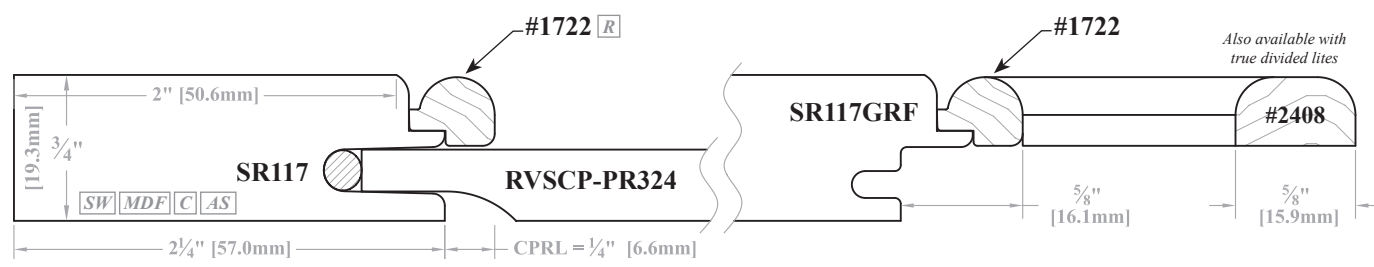

PC: AM102 Multiplier: .72 (#1629)

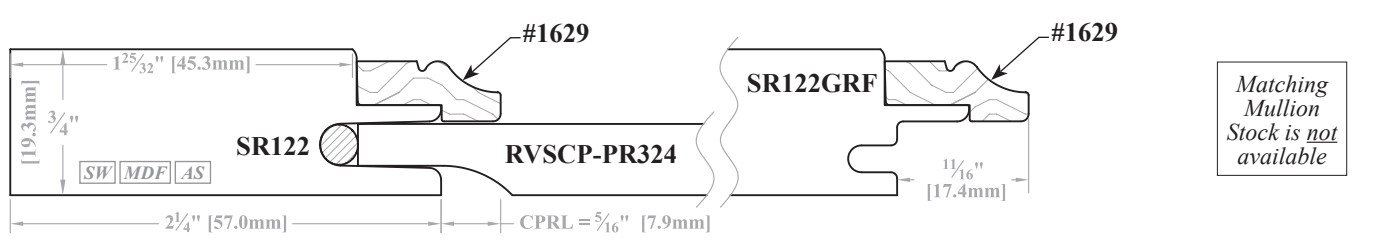

SW = Available in Solid Wood. **C** = Stile/Rail & Applied Molding combo shown are available Convex/Concave **AS** = Available on Adventure Series Doors.
R = Available radiused to follow contour of shaped rails. **MDF** = Stile/Rail profile available on 5-piece MDF doors. Applied molding will be solid wood.

► For PRICING ► See Section E.5 in our current Wholesale Pricing Catalog.

Profile Options

Stile & Rail - Shelf Applied Molding

Shelf Applied Molding Applications with Matching Mullion Stock - 3/4" [19.3mm] Thick Doors

PC: AM102 Multiplier: .72 (#1746)

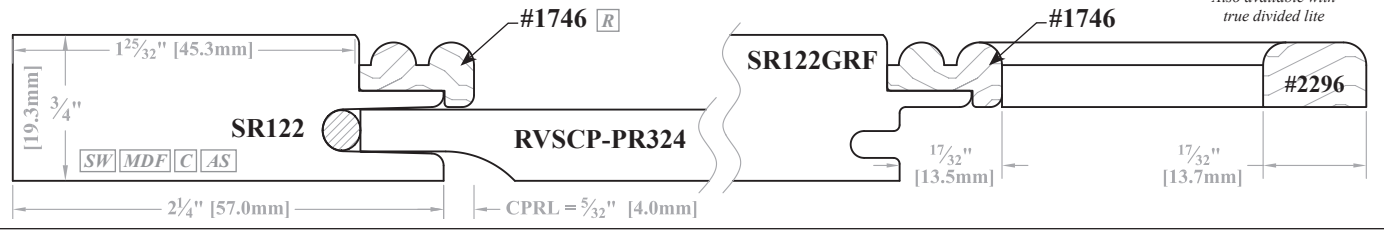

PC: AM101 Multiplier: .72 (#1360)

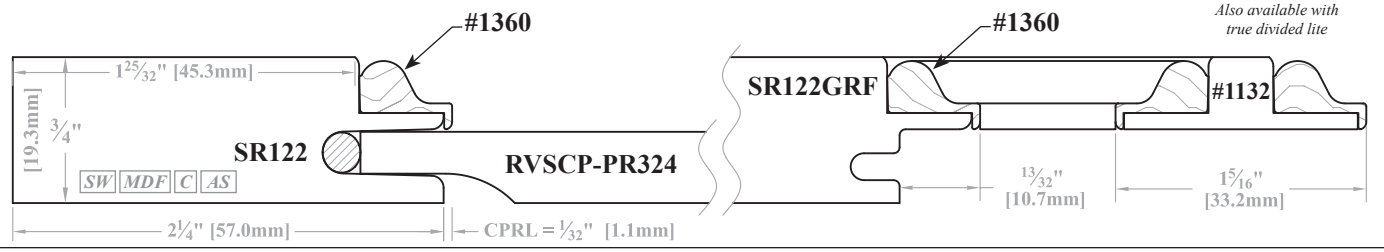

PC: AM102 Multiplier: .72 (#1280)
PC: AM101 Multiplier: .72 (#963 - GRF Extension Molding)

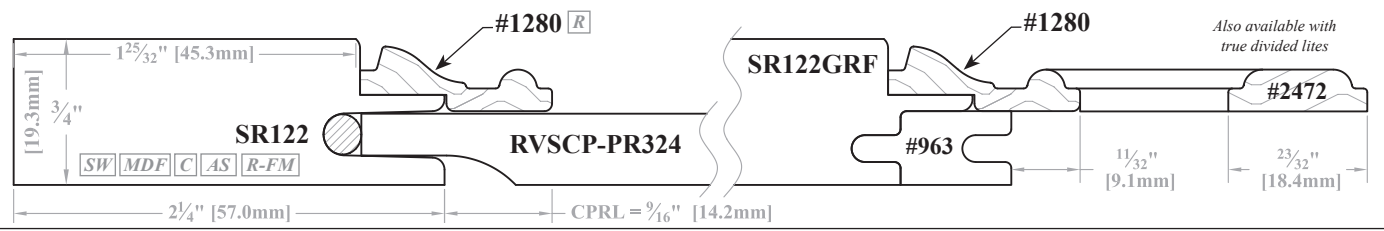

PC: AM102 Multiplier: .72 (#1344)

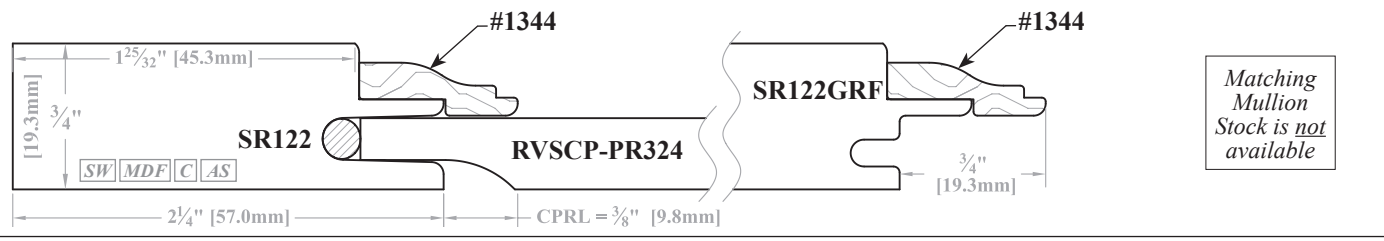

[SW] = Available in Solid Wood. [C] = Stile/Rail & Applied Molding combo shown are available Convex/Concave [AS] = Available on Adventure Series Doors.
[R] = Available radiused to follow contour of shaped rails. [MDF] = Stile/Rail profile available on 5-piece MDF doors. Applied molding will be solid wood.

► For PRICING ► See Section E.5 in our current Wholesale Pricing Catalog.

Shelf Applied Molding Applications with Matching Mullion Stock - 3/4" [19.3mm] Thick Doors

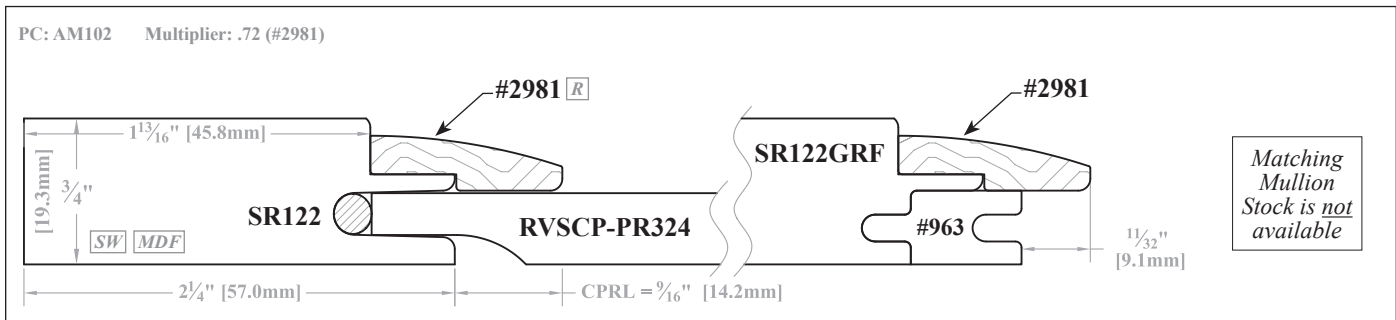
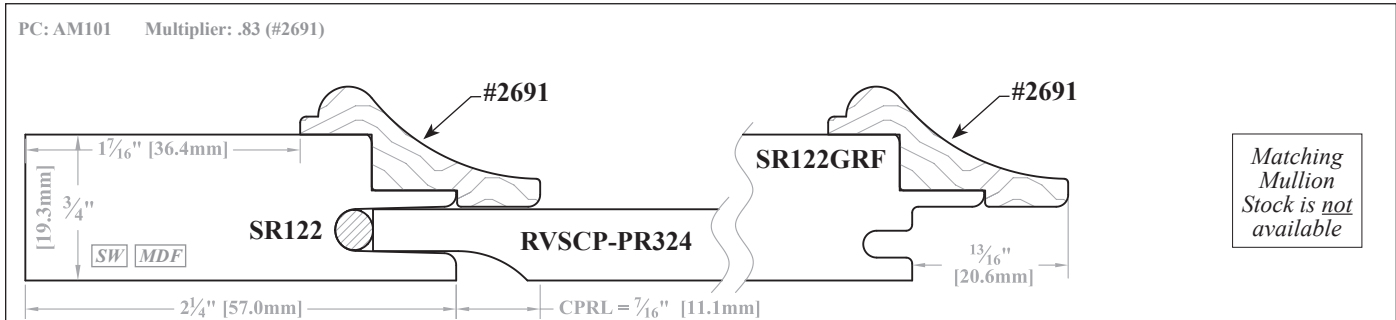
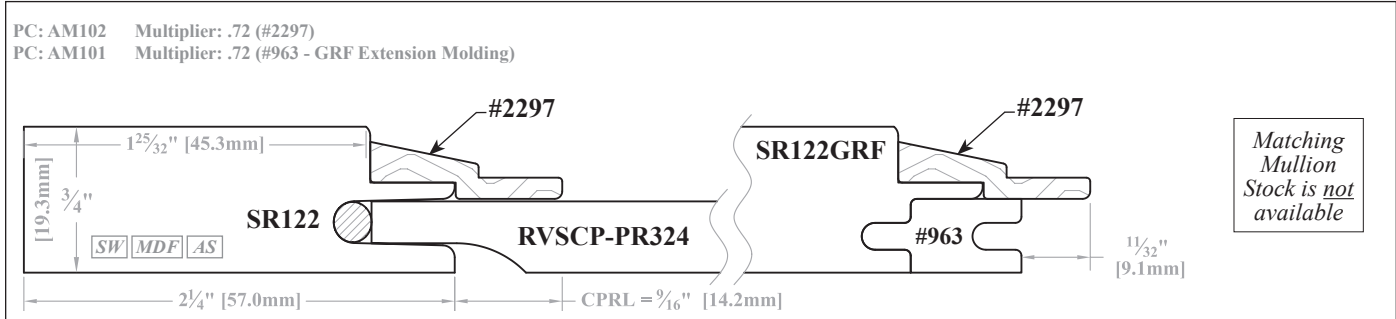
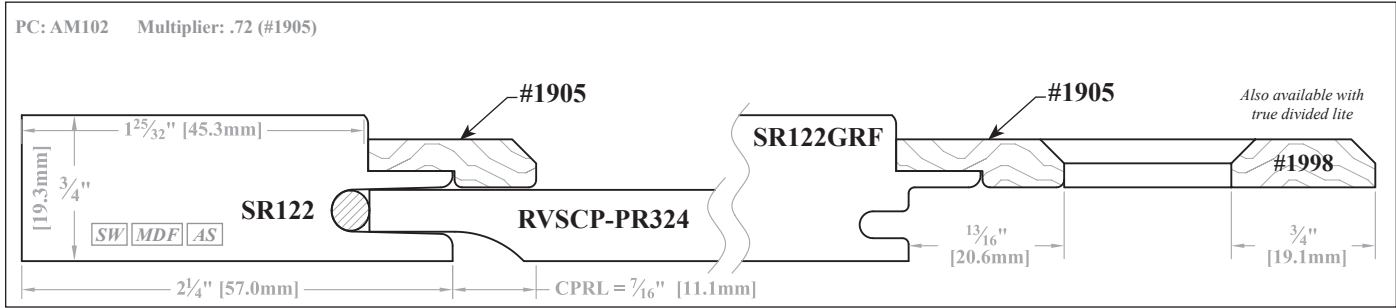
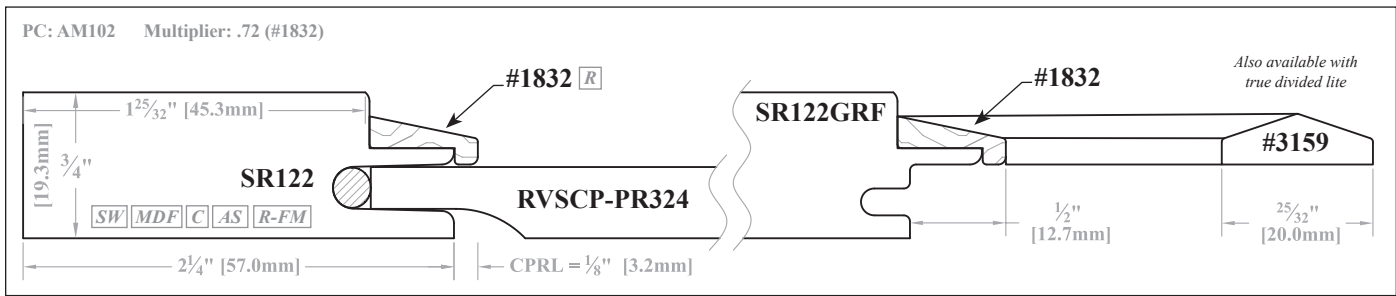

SW = Available in Solid Wood. C = Stile/Rail & Applied Molding combo shown are available Convex/Concave AS = Available on Adventure Series Doors.
R = Available radiused to follow contour of shaped rails. MDF = Stile/Rail profile available on 5-piece MDF doors. Applied molding will be solid wood.

► For PRICING ► See Section E.5 in our current Wholesale Pricing Catalog.

Profile Options

Stile & Rail - Shelf Applied Molding

Shelf Applied Molding Applications with Matching Mullion Stock - 3/4" [19.3mm] Thick Doors

PC: AM101 Multiplier: .83 (#2982)

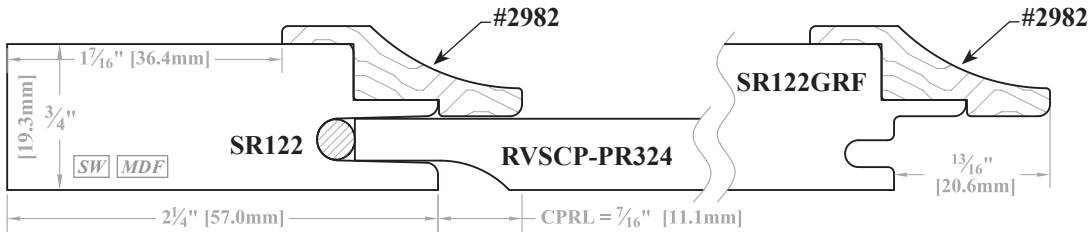

Matching Mullion Stock is not available

PC: AM101 Multiplier: .92 (#3146)
PC: AM101 Multiplier: .72 (#888 - GRF Extension Molding)

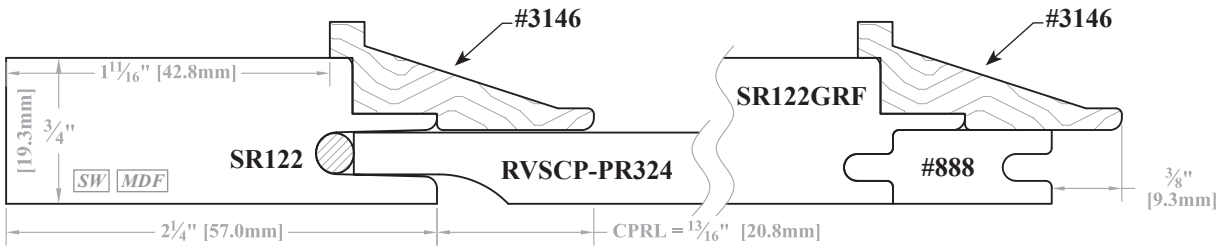

Matching Mullion Stock is not available

PC: AM102 Multiplier: .72 (#1721)

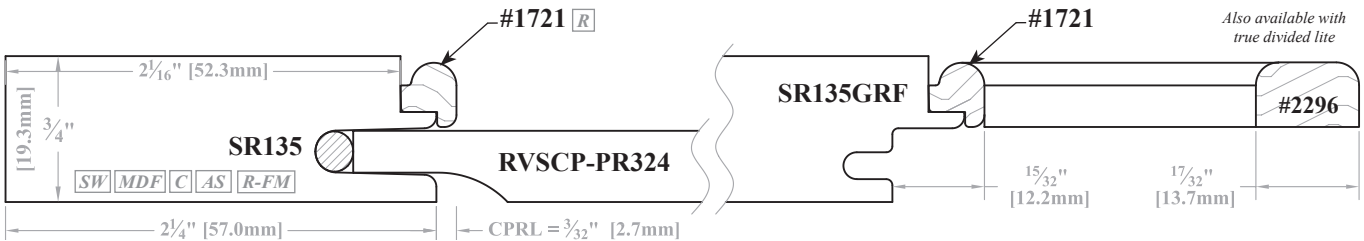

Also available with true divided lite

PC: AM101 Multiplier: .72 (#1722)

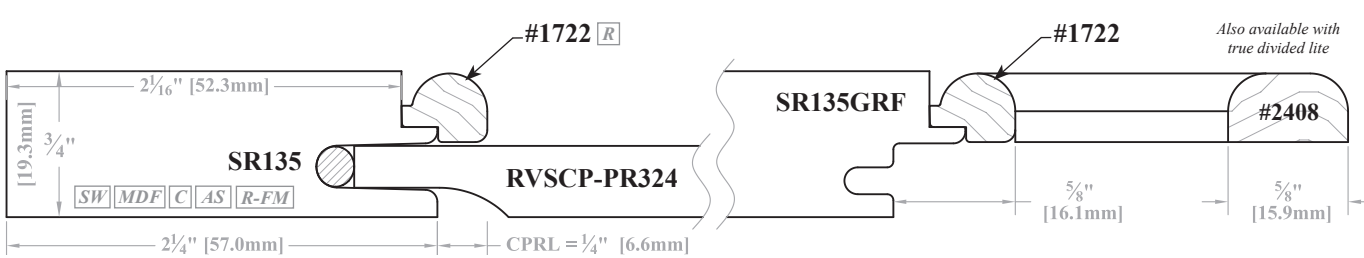

Also available with true divided lite

PC: AM102 Multiplier: .72 (#1752)



Also available with true divided lite

SW = Available in Solid Wood. C = Stile/Rail & Applied Molding combo shown are available Convex/Concave AS = Available on Adventure Series Doors.
R = Available radiused to follow contour of shaped rails. MDF = Stile/Rail profile available on 5-piece MDF doors. Applied molding will be solid wood.

► For PRICING ► See Section E.5 in our current Wholesale Pricing Catalog.

Shelf Applied Molding Applications with Matching Mullion Stock - 3/4" [19.3mm] Thick Doors

PC: AM102 Multiplier: .72 (#1755)

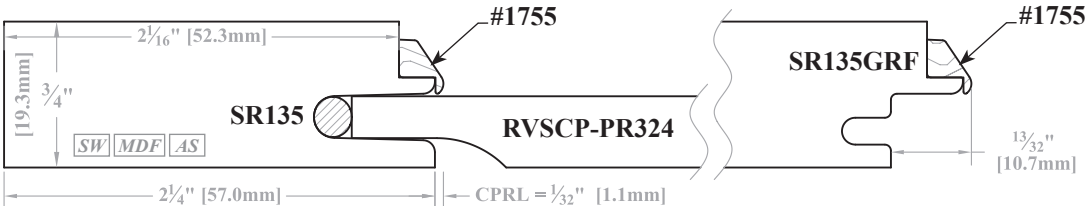

Matching Mullion Stock is not available

PC: AM102 Multiplier: .72 (#1770)

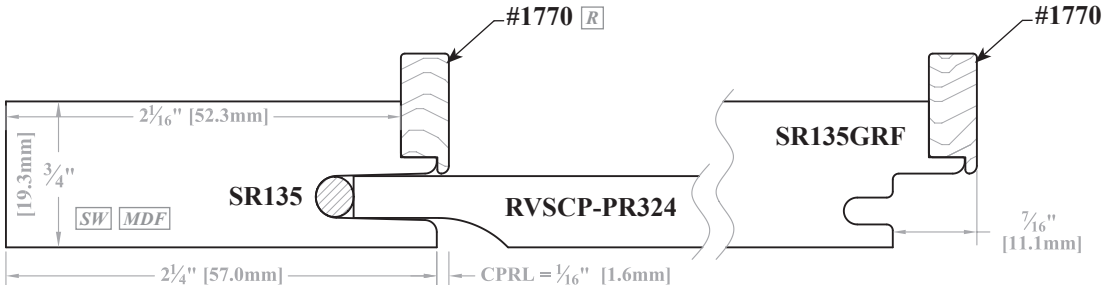

Matching Mullion Stock is not available

PC: AM102 Multiplier: .72 (#1834)

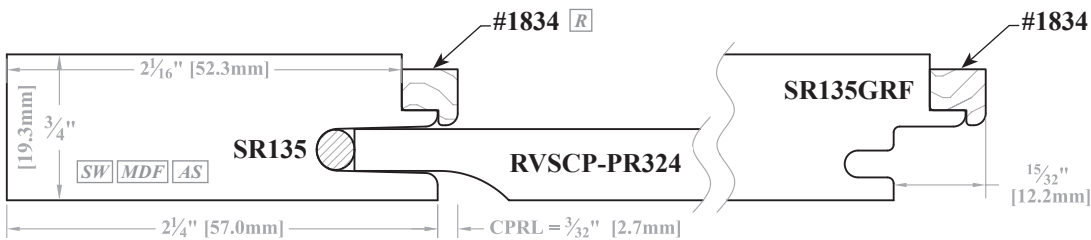

Matching Mullion Stock is not available

PC: AM102 Multiplier: .72 (#1858)

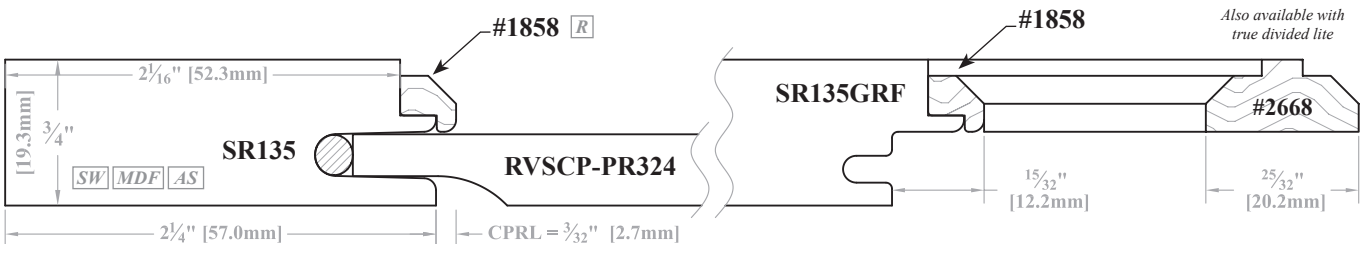

Also available with true divided lite

PC: AM102 Multiplier: .72 (#1861)

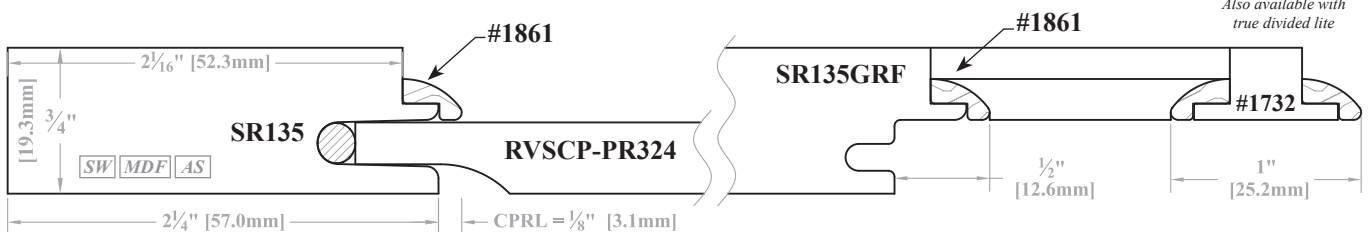

Also available with true divided lite

[SW] = Available in Solid Wood.

[C] = Stile/Rail & Applied Molding combo shown are available Convex/Concave

[AS] = Available on Adventure Series Doors.

[R] = Available radiused to follow contour of shaped rails.

[MDF] = Stile/Rail profile available on 5-piece MDF doors. Applied molding will be solid wood.

► For PRICING ► See Section E.5 in our current Wholesale Pricing Catalog.

Profile Options

Stile & Rail - Shelf Applied Molding

Shelf Applied Molding Applications with Matching Mullion Stock - 3/4" [19.3mm] Thick Doors

PC: AM101 Multiplier: .72 (#2053)

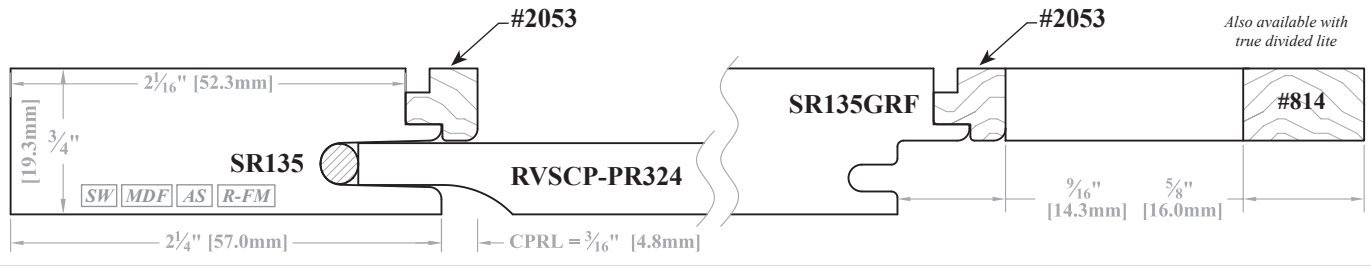

PC: AM101 Multiplier: .72 (#2630)

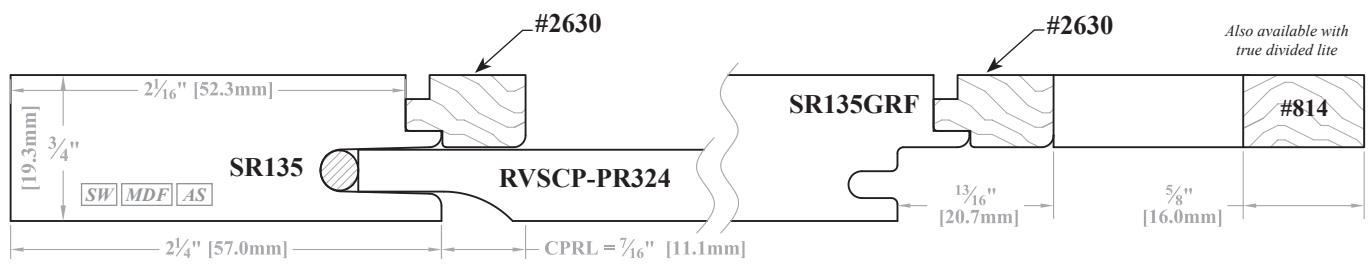

PC: AM101 Multiplier: .72 (#3076)

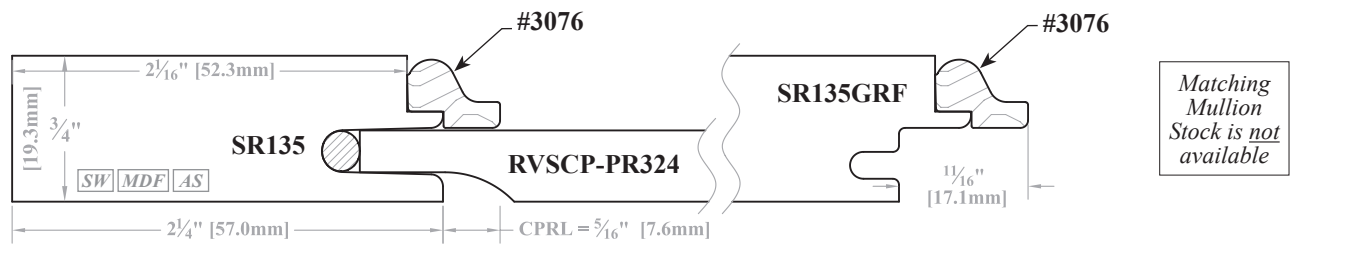

PC: AM101 Multiplier: .72 (#1360)

* Applied Molding #1360 is not available with Shaped Rails.

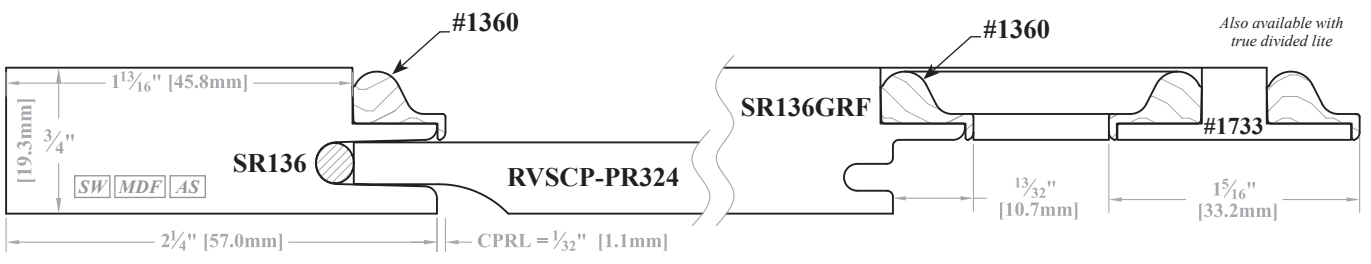

PC: AM102 Multiplier: .72 (#1745)

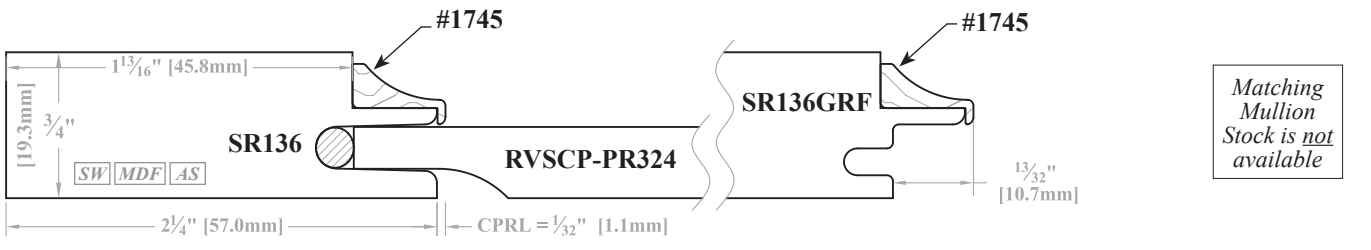

► For PRICING ► See Section E.5 in our current Wholesale Pricing Catalog.

Shelf Applied Molding Applications with Matching Mullion Stock - 3/4" [19.3mm] Thick Doors

PC: AM102 Multiplier: .72 (#1746)

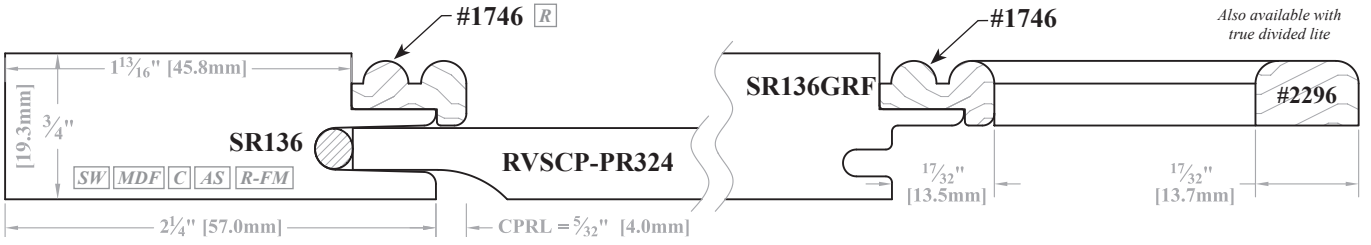

Molding #1108 is an Embossed Egg & Dart Molding
See Outsourced Applied Moldings for Top View, Wood Species Options and Pricing.

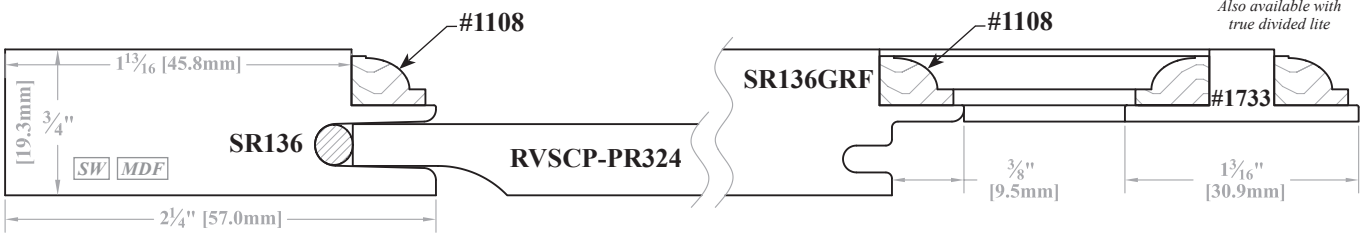

PC: AM102 Multiplier: .84 (#1875)
PC: AM101 Multiplier: .72 (#888 - GRF Extension Molding)

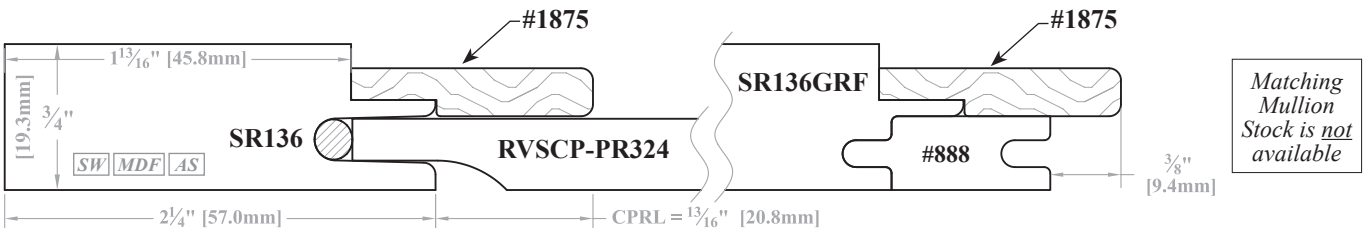

PC: AM102 Multiplier: 0.72 (#1876)

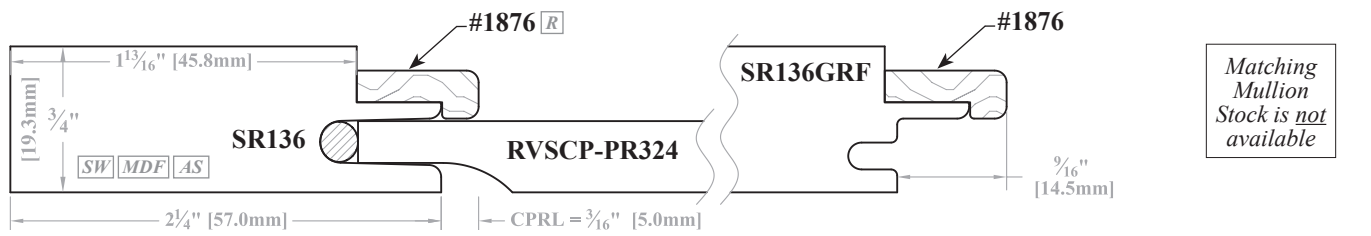

PC: AM101 Multiplier: 0.72 (#1363)

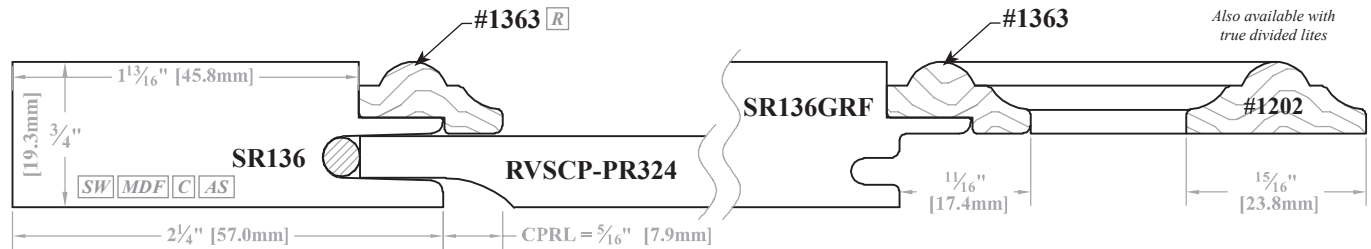

SW = Available in Solid Wood. C = Stile/Rail & Applied Molding combo shown are available Convex/Concave AS = Available on Adventure Series Doors.
R = Available radiused to follow contour of shaped rails. MDF = Stile/Rail profile available on 5-piece MDF doors. Applied molding will be solid wood.

► For PRICING ► See Section E.5 in our current Wholesale Pricing Catalog.

Profile Options

Stile & Rail - Shelf Applied Molding

Shelf Applied Molding Applications with Matching Mullion Stock - 3/4" [19.3mm] Thick Doors

PC: AM102 Multiplier: .72 (#1880)

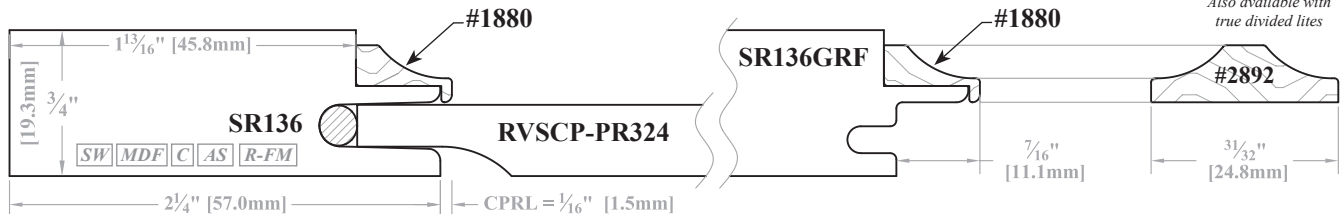

PC: AM102 Multiplier: .72 (#1912)



PC: AM102 Multiplier: .75 (#1922)
PC: AM101 Multiplier: .72 (#888 - GRF Extension Molding)

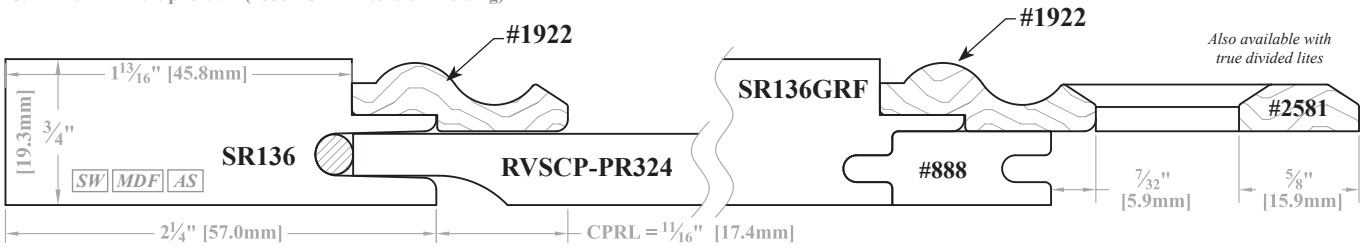

Molding #1999 is a Plain Egg & Dart Molding
See Outsourced Applied Moldings for Top View, Wood Species Options and Pricing.

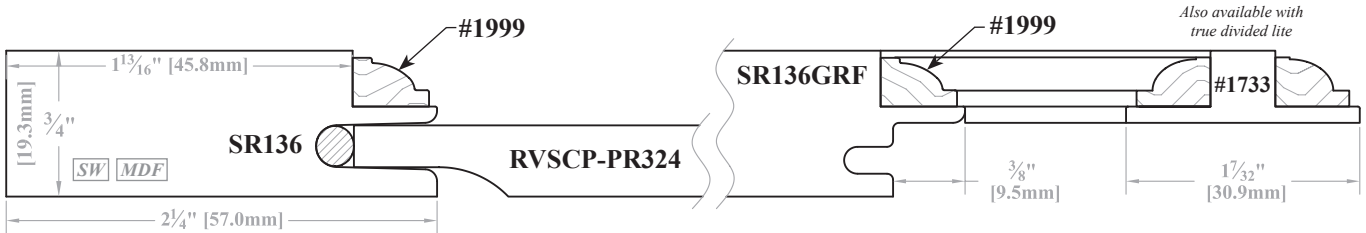

PC: AM102 Multiplier: .72 (#2022)

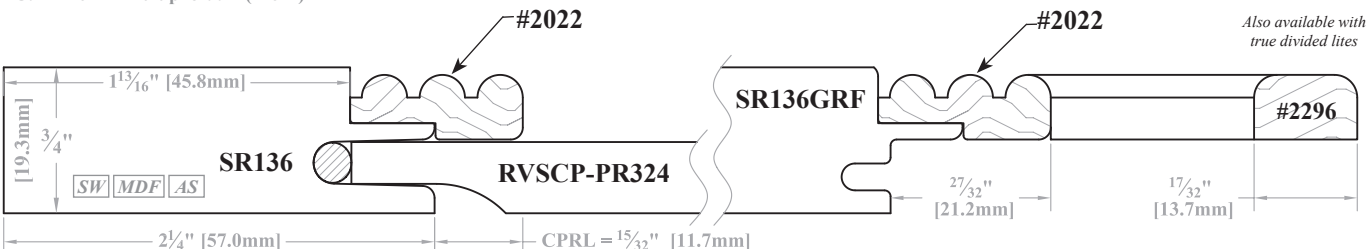

[SW] = Available in Solid Wood. [C] = Stile/Rail & Applied Molding combo shown are available Convex/Concave [AS] = Available on Adventure Series Doors.
[R] = Available radiused to follow contour of shaped rails. [MDF] = Stile/Rail profile available on 5-piece MDF doors. Applied molding will be solid wood.

► For PRICING ► See Section E.5 in our current Wholesale Pricing Catalog.

Shelf Applied Molding Applications with Matching Mullion Stock - 3/4" [19.3mm] Thick Doors

PC: AM102 Multiplier: .72 (#2095)

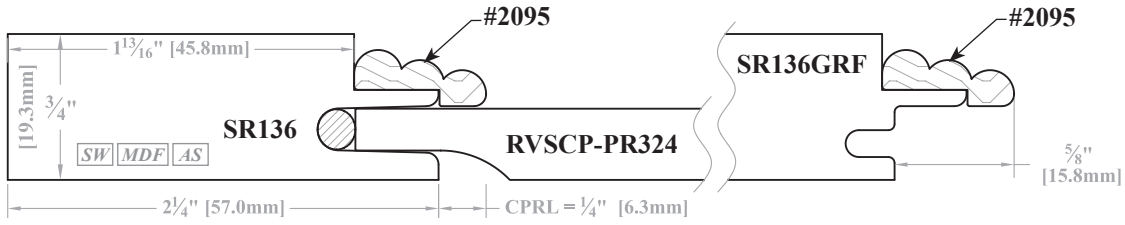

Matching Mullion Stock is *not* available

PC: AM102 Multiplier: .72 (#2627)

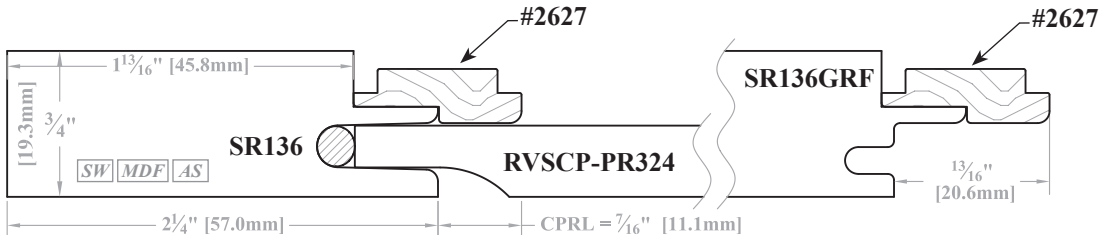

Matching Mullion Stock is *not* available

PC: AM101 Multiplier: .72 (#2643)

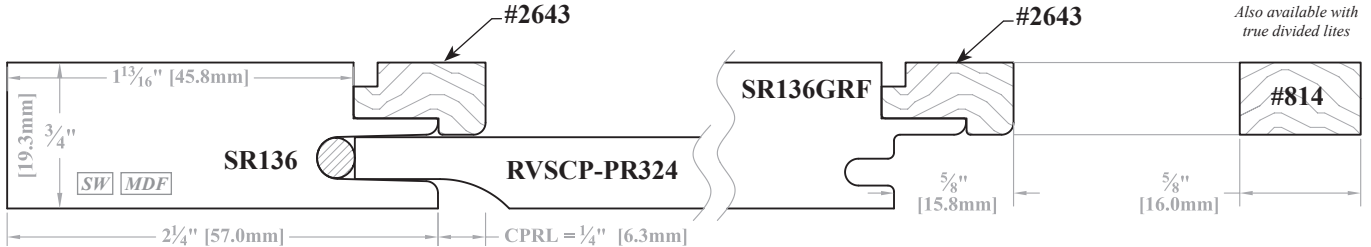

Also available with true divided lites

PC: AM102 Multiplier: .72 (#2690)

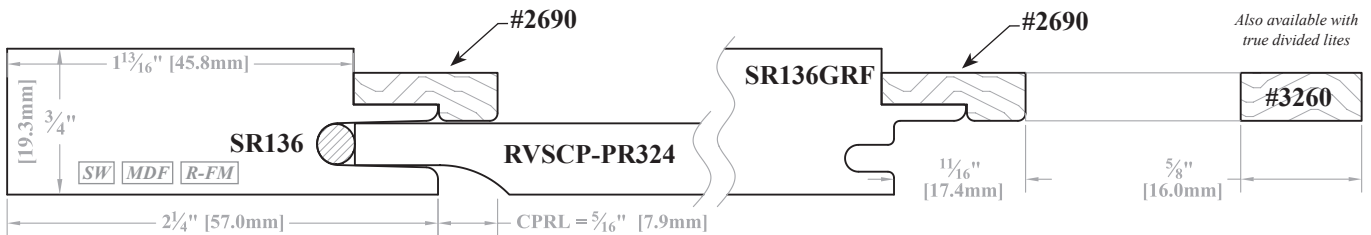

Also available with true divided lites

PC: AM102 Multiplier: .72 (#2789)
PC: AM101 Multiplier: .72 (#963 - GRF Extension Molding)

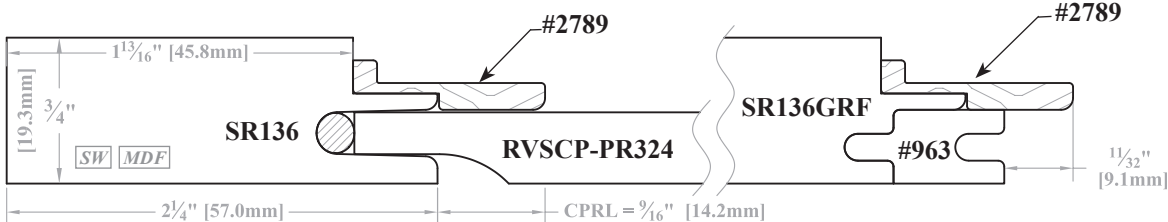

Matching Mullion Stock is *not* available

[SW] = Available in Solid Wood. [C] = Stile/Rail & Applied Molding combo shown are available Convex/Concave [AS] = Available on Adventure Series Doors.
[R] = Available radiused to follow contour of shaped rails. [MDF] = Stile/Rail profile available on 5-piece MDF doors. Applied molding will be solid wood.

► For PRICING ► See Section E.5 in our current Wholesale Pricing Catalog.

Profile Options

Stile & Rail - Shelf Applied Molding

Shelf Applied Molding Applications with Matching Mullion Stock - 3/4" [19.3mm] Thick Doors

PC: AM101 Multiplier: .83 (#2955)

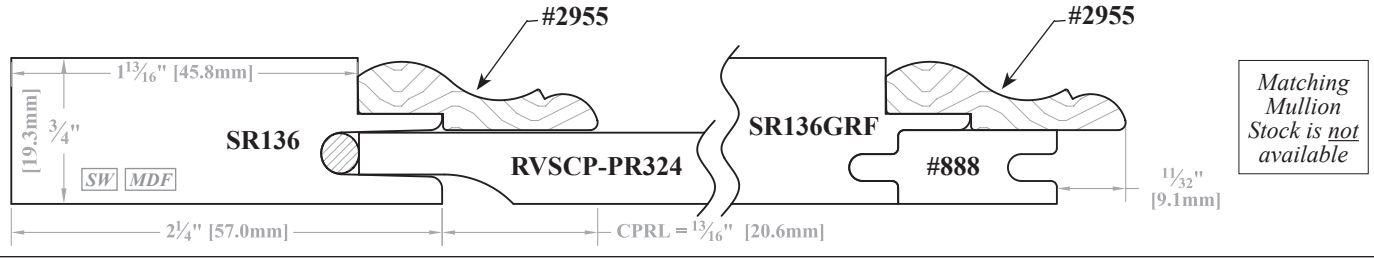

PC: AM101 Multiplier: .84 (#3122)

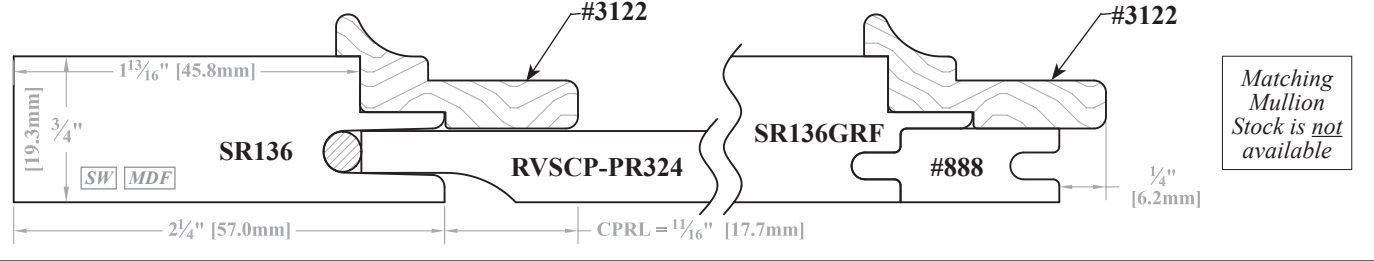

PC: AM101 Multiplier: .72 (#3147)

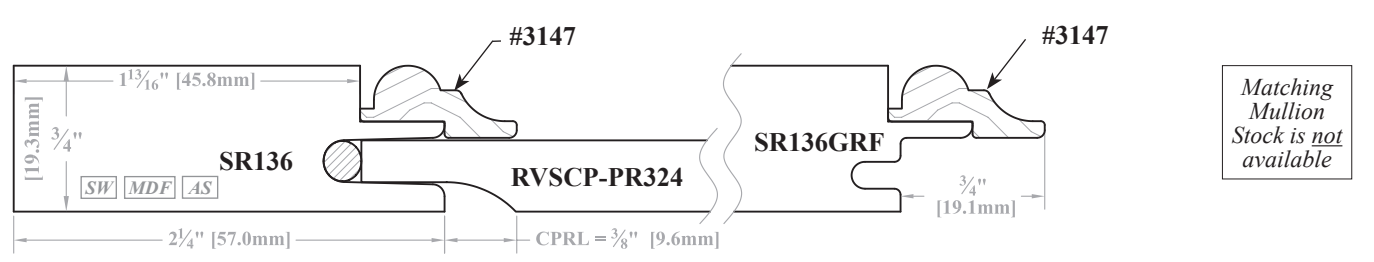

Molding #3162 is an Embossed Egg & Dart Molding
See Outsourced Applied Moldings for Top View, Wood Species Options and Pricing.

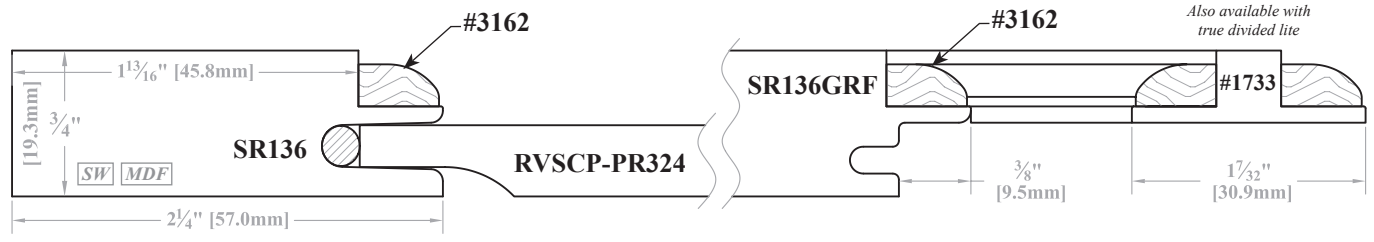

PC: AM101 Multiplier: .87 (#3203)

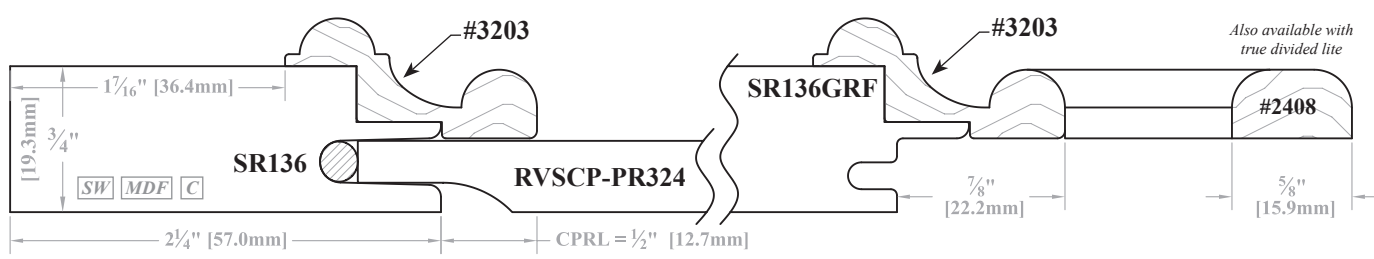

SW = Available in Solid Wood. C = Stile/Rail & Applied Molding combo shown are available Convex/Concave AS = Available on Adventure Series Doors.
R = Available radiused to follow contour of shaped rails. MDF = Stile/Rail profile available on 5-piece MDF doors. Applied molding will be solid wood.

► For PRICING ► See Section E.5 in our current Wholesale Pricing Catalog.

Shelf Applied Molding Applications with Matching Mullion Stock - 3/4" [19.3mm] Thick Doors

PC: AM102 Multiplier: .72 (#1862)

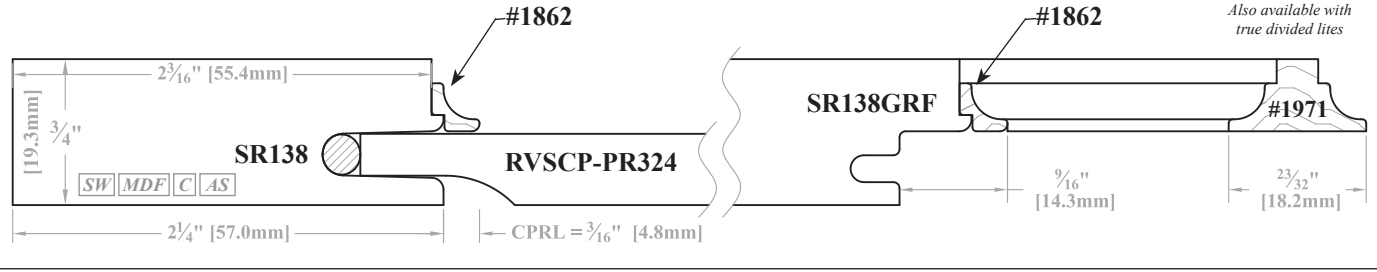

PC: AM101 Multiplier: .72 (#2637)

SR144 is a Mirror Joint. See Section E.2 for more information.

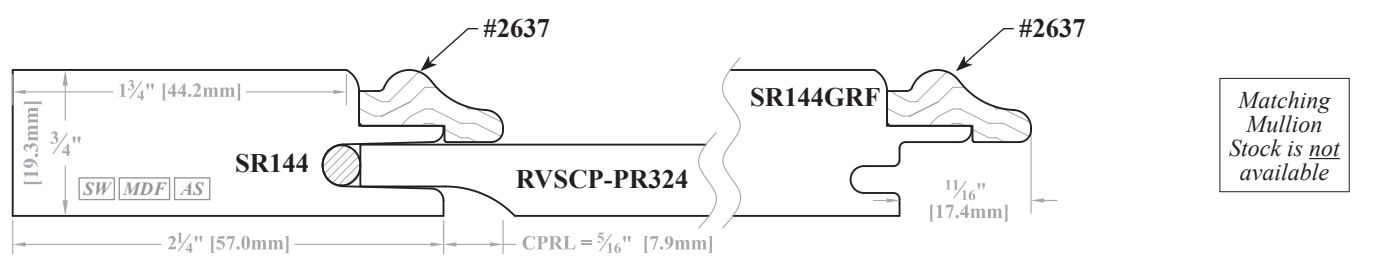

PC: AM102 Multiplier: .72 (#2638)

SR144 is a Mirror Joint. See Section E.2 for more information.

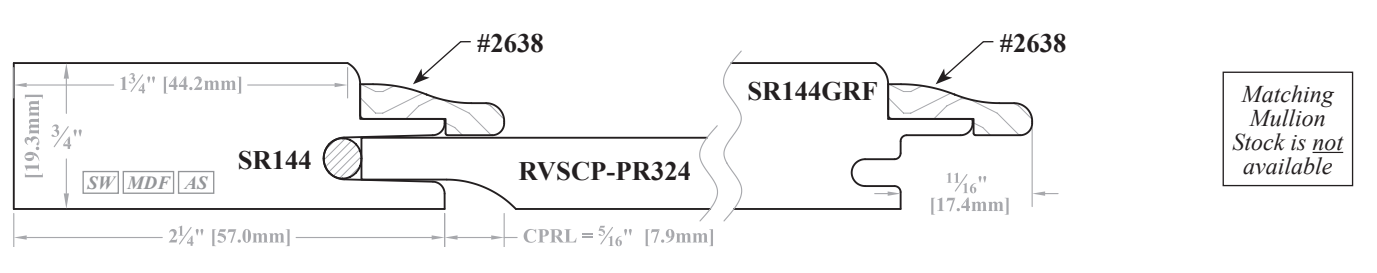

Molding #2381 is an Embossed Beaded Molding. See Outsourced Applied Moldings for Top View, Wood Species Options and Pricing.

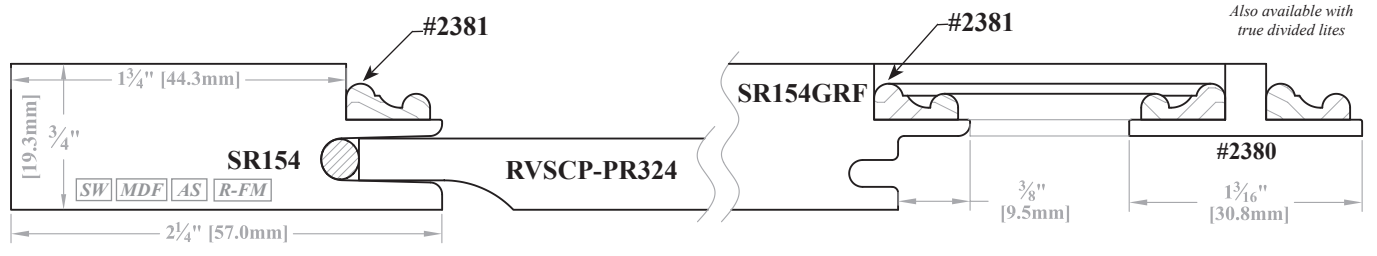

[SW] = Available in Solid Wood. [C] = Stile/Rail & Applied Molding combo shown are available Convex/Concave [AS] = Available on Adventure Series Doors. [R] = Available radiused to follow contour of shaped rails. [MDF] = Stile/Rail profile available on 5-piece MDF doors. Applied molding will be solid wood.

► For PRICING ► See Section E.5 in our current Wholesale Pricing Catalog.

Profile Options

Stile & Rail - Shelf Applied Molding

Shelf Applied Molding Applications with Matching Mullion Stock - 3/4" [19.3mm] Thick Doors

PC: AM102 Multiplier: .72 (#2588)

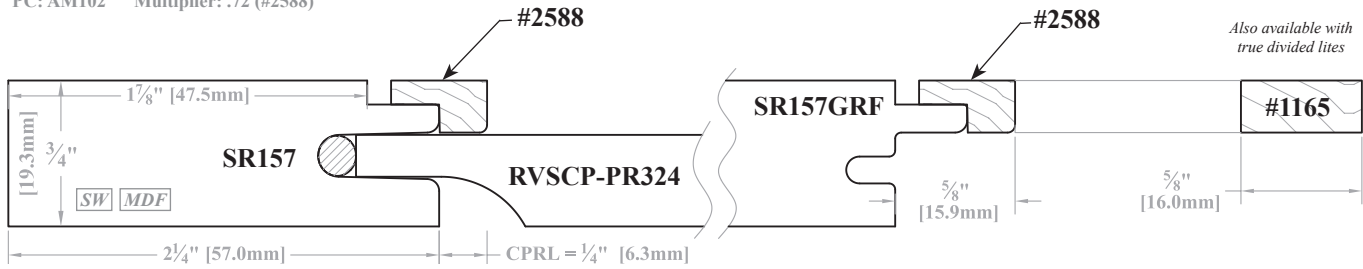

PC: AM102 Multiplier: .72 (#2528)

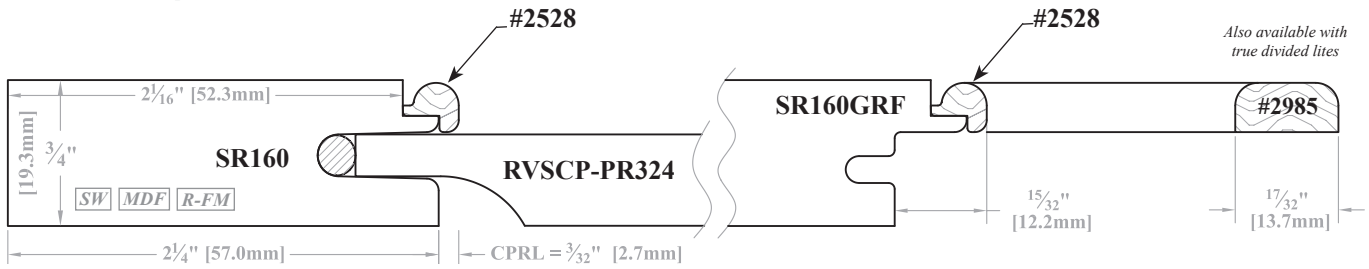

PC: AM102 Multiplier: .72 (#2849)

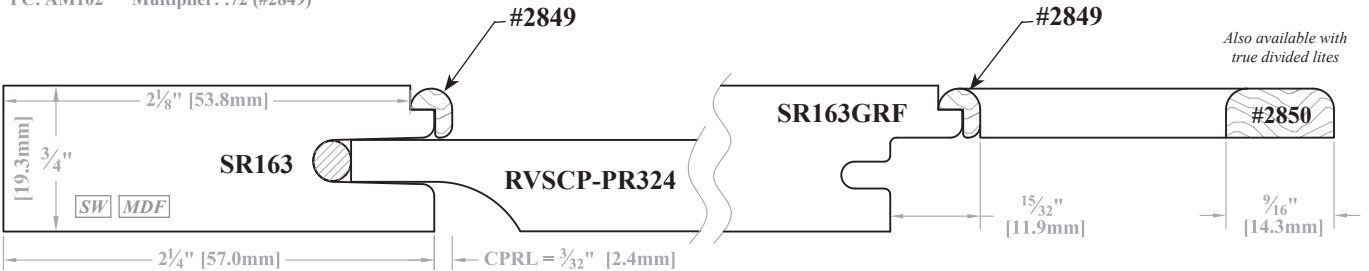

Shelf Applied Quarter Round Rope Moldings - 3/4" [19.1mm] Thick Doors

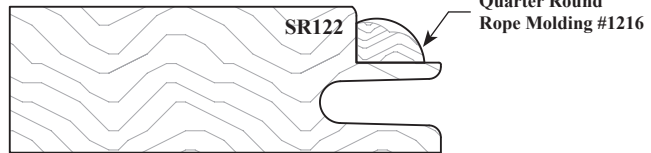
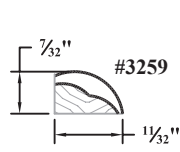
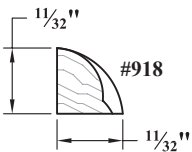
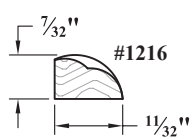
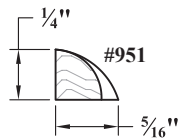

* See Section E.8 of the Wholesale Pricing Catalog for Outsourced Applied Molding Wood Species & Pricing.

[SW] = Available in Solid Wood.
 [C] = Stile/Rail & Applied Molding combo shown are available Convex/Concave
 [AS] = Available on Adventure Series Doors.
[R] = Available radiused to follow contour of shaped rails.
 [MDF] = Stile/Rail profile available on 5-piece MDF doors. Applied molding will be solid wood.

► For PRICING ► See Section E.5 in our current Wholesale Pricing Catalog.

SR133 - Shelf Applied Molding Applications with Matching Mullion Stock - 3/4" [19.3mm] Thick Doors

PC: AM101 Multiplier: .83 (#1811)

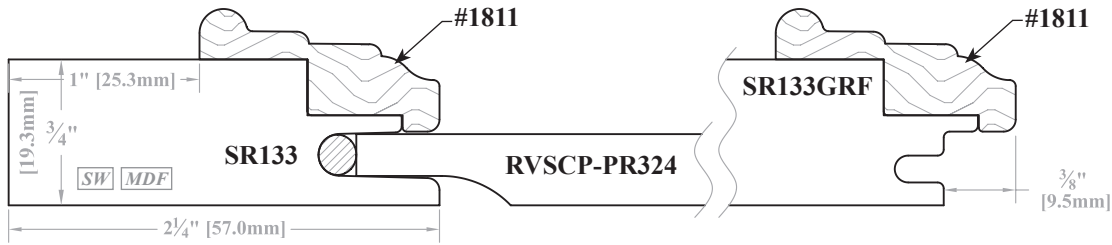

Matching Mullion Stock is *not* available

PC: AM102 Multiplier: .72 (#1718)



Also available with true divided lites

PC: AM102 Multiplier: .72 (#1657)



Also available with true divided lites

PC: AM102 Multiplier: .72 (#1717)

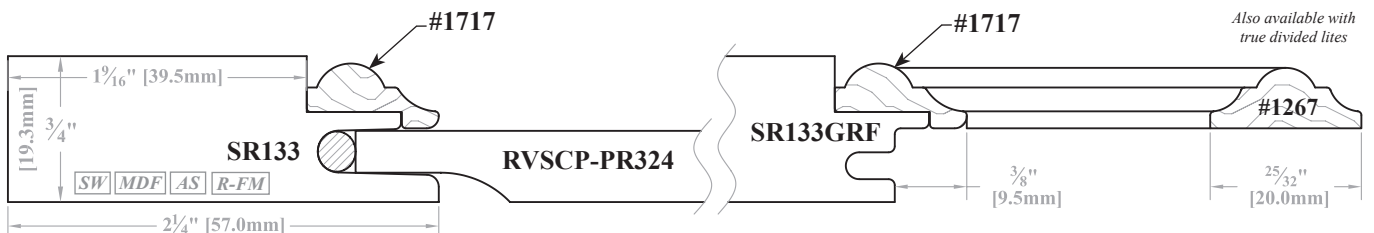

See Profile Options notes in Section B.12 for alternative mullion.

Also available with true divided lites

PC: AM101 Multiplier: .72 (#1661)



Also available with true divided lites

SW = Available in Solid Wood.

C = Stile/Rail & Applied Molding combo shown are available Convex/Concave

AS = Available on Adventure Series Doors.

R = Available radiused to follow contour of shaped rails.

MDF = Stile/Rail profile available on 5-piece MDF doors. Applied molding will be solid wood.

► For PRICING ► See Section E.5 in our current Wholesale Pricing Catalog.

Profile Options

Stile & Rail - Shelf Applied Molding

SR133 - Shelf Applied Molding Applications with Matching Mullion Stock - 3/4" [19.3mm] Thick Doors

PC: AM102 Multiplier: .72 (#1664)



PC: AM101 Multiplier: .72 (#1663)



PC: AM101 Multiplier: .73 (#1692)

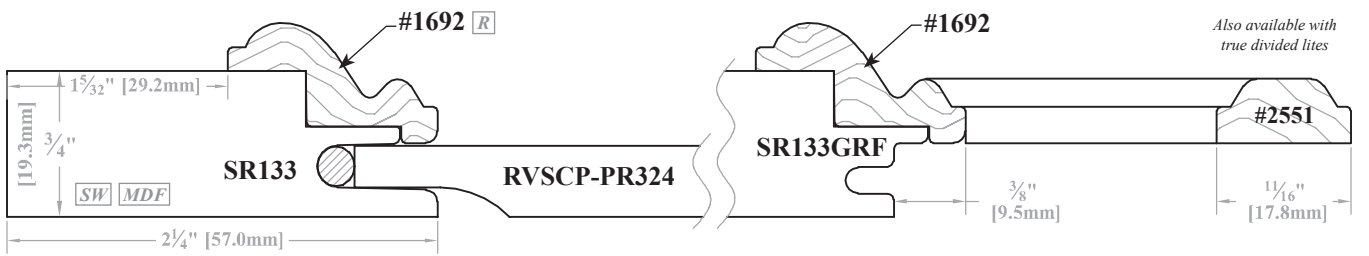

PC: AM102 Multiplier: .72 (#3053)

See Profile Options notes in Section B.12 for alternative mullion.

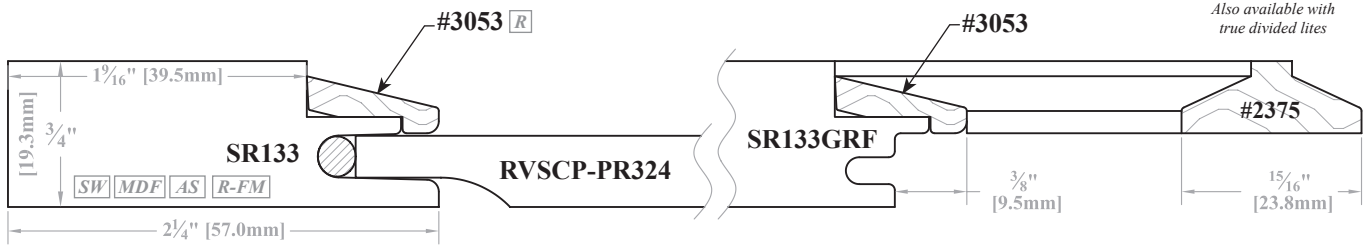

PC: AM101 Multiplier: .72 (#1864)

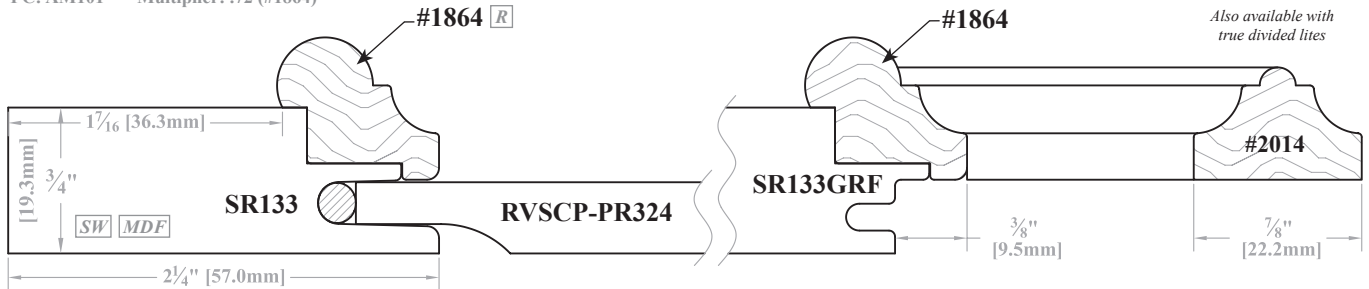

[SW] = Available in Solid Wood. [C] = Stile/Rail & Applied Molding combo shown are available Convex/Concave [AS] = Available on Adventure Series Doors.
[R] = Available radiused to follow contour of shaped rails. [MDF] = Stile/Rail profile available on 5-piece MDF doors. Applied molding will be solid wood.

► For PRICING ► See Section E.5 in our current Wholesale Pricing Catalog.

SR133 - Shelf Applied Molding Applications with Matching Mullion Stock - 3/4" [19.3mm] Thick Doors

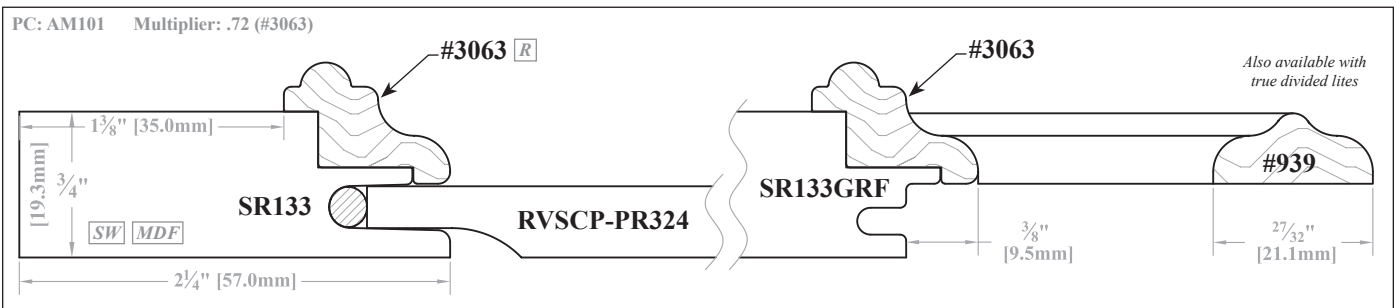
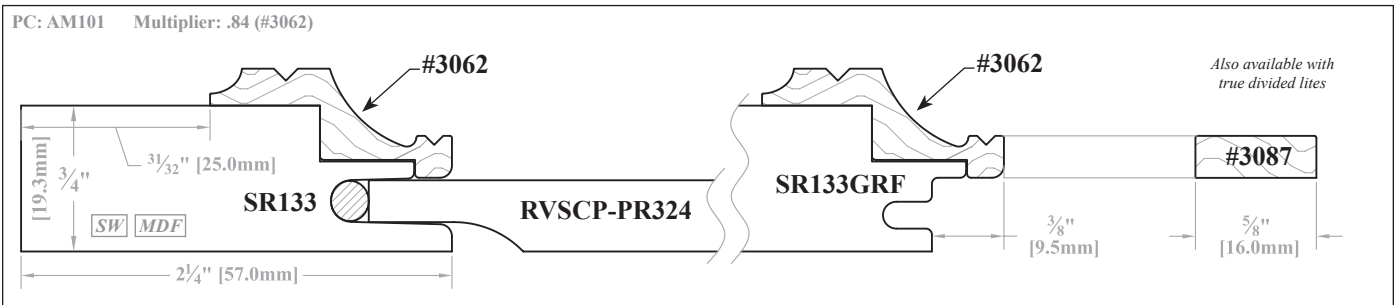
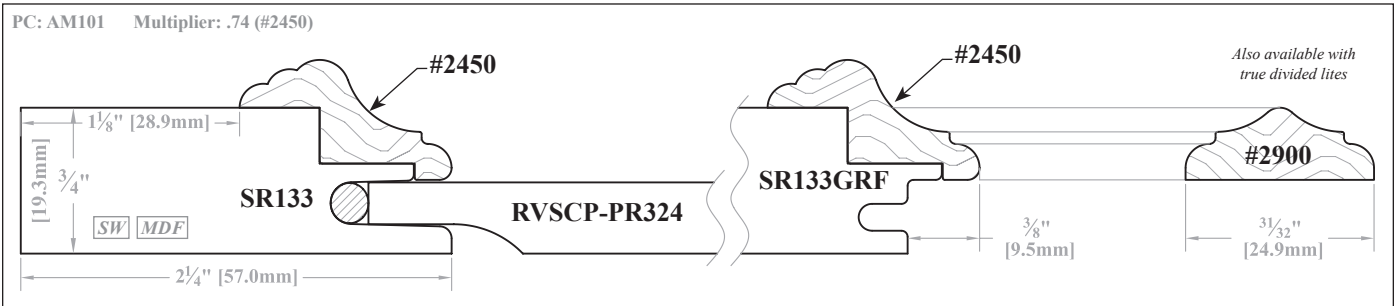
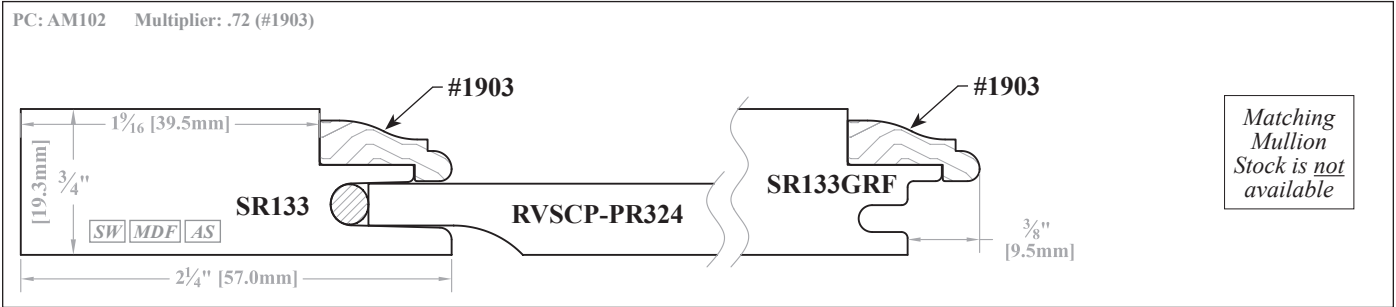
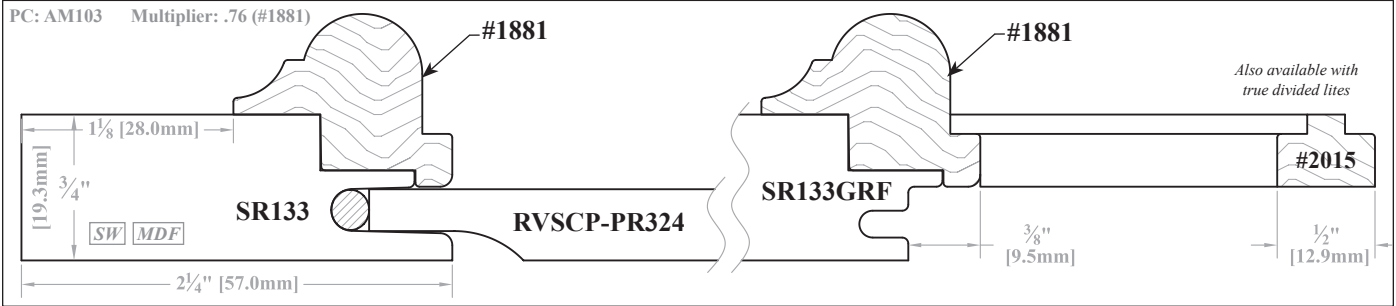

SW = Available in Solid Wood. C = Stile/Rail & Applied Molding combo shown are available Convex/Concave AS = Available on Adventure Series Doors.
 R = Available radiused to follow contour of shaped rails. MDF = Stile/Rail profile available on 5-piece MDF doors. Applied molding will be solid wood.

► For PRICING ► See Section E.5 in our current Wholesale Pricing Catalog.

Profile Options

Stile & Rail - Shelf Applied Molding

SR133 - Shelf Applied Molding Applications with Matching Mullion Stock - 3/4" [19.3mm] Thick Doors

PC: AM101 Multiplier: .90 (#3064)

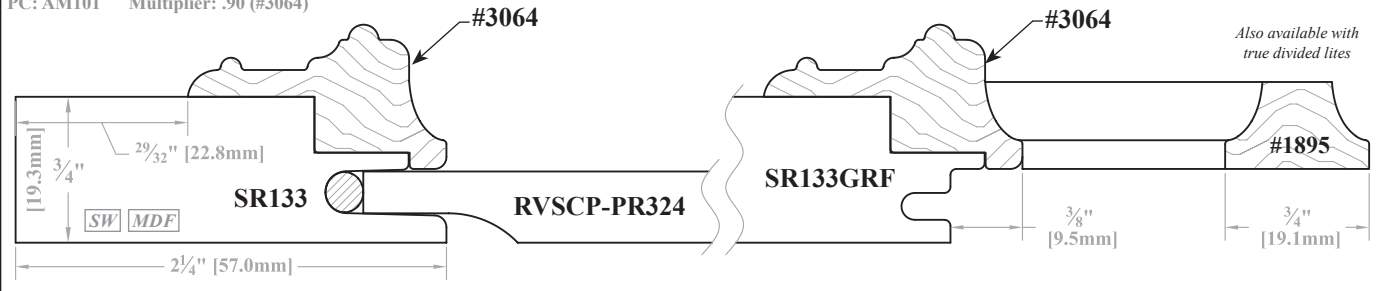

PC: AM101 Multiplier: .94 (#3065)

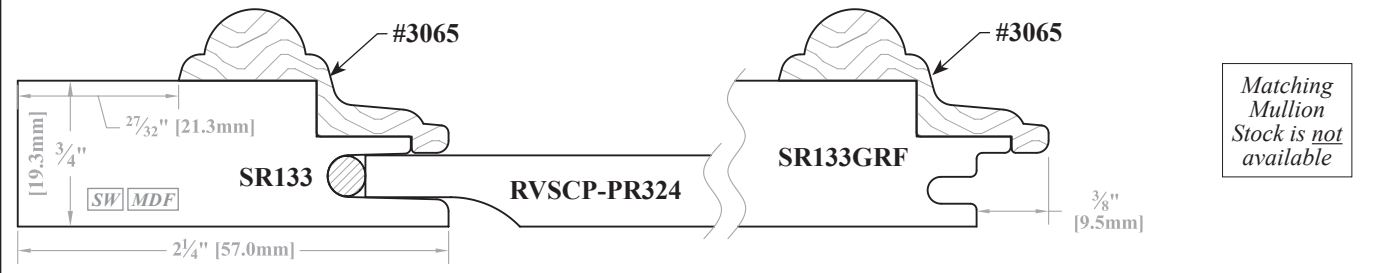

PC: AM101 Multiplier: .84 (#3066)

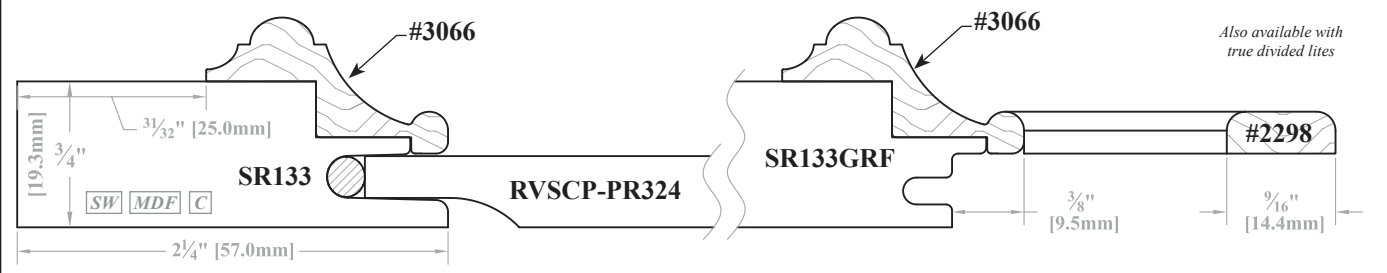

PC: AM101 Multiplier: .72 (#3067)

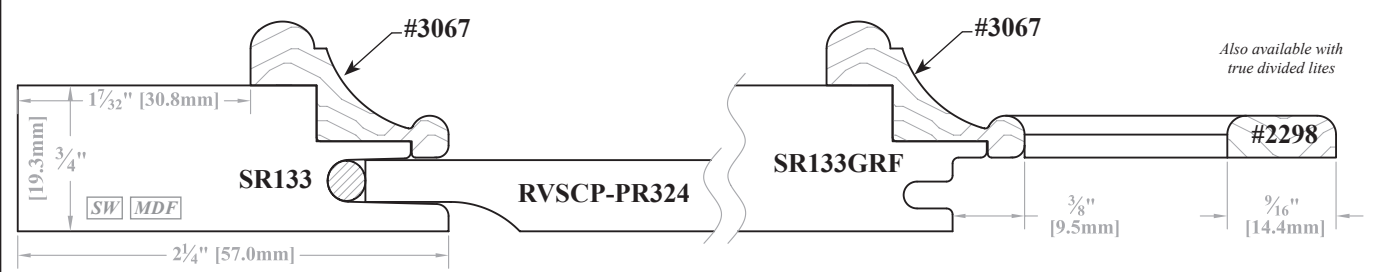

PC: AM101 Multiplier: .82 (#3068)

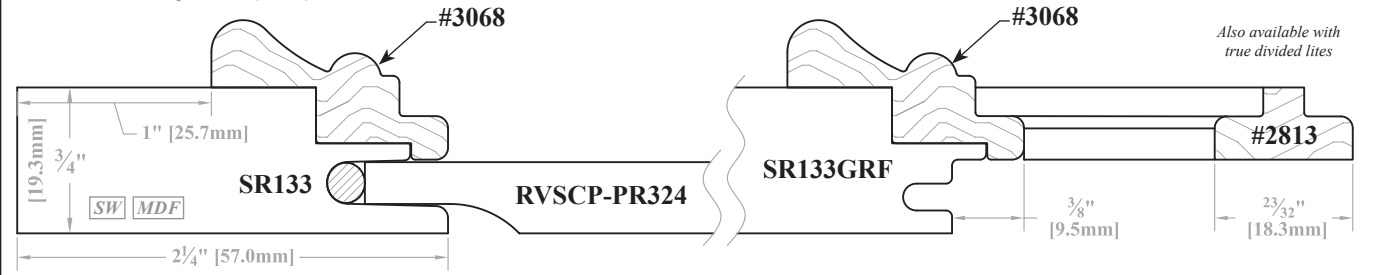

[SW] = Available in Solid Wood.
 [C] = Stile/Rail & Applied Molding combo shown are available Convex/Concave
 [AS] = Available on Adventure Series Doors.
[R] = Available radiused to follow contour of shaped rails.
 [MDF] = Stile/Rail profile available on 5-piece MDF doors. Applied molding will be solid wood.

► For PRICING ► See Section E.5 in our current Wholesale Pricing Catalog.

SR133 - Shelf Applied Molding Applications with Matching Mullion Stock - 3/4" [19.3mm] Thick Doors

PC: AM103 Multiplier: 1.0 (#3069)

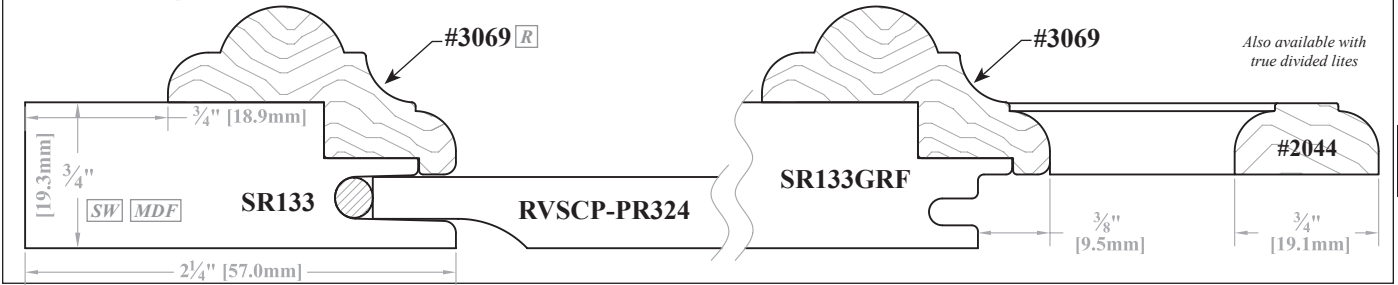

PC: AM101 Multiplier: .72 (#3070)



PC: AM101 Multiplier: .72 (#3071)



PC: AM101 Multiplier: .72 (#3072)



PC: AM101 Multiplier: .75 (#3073)

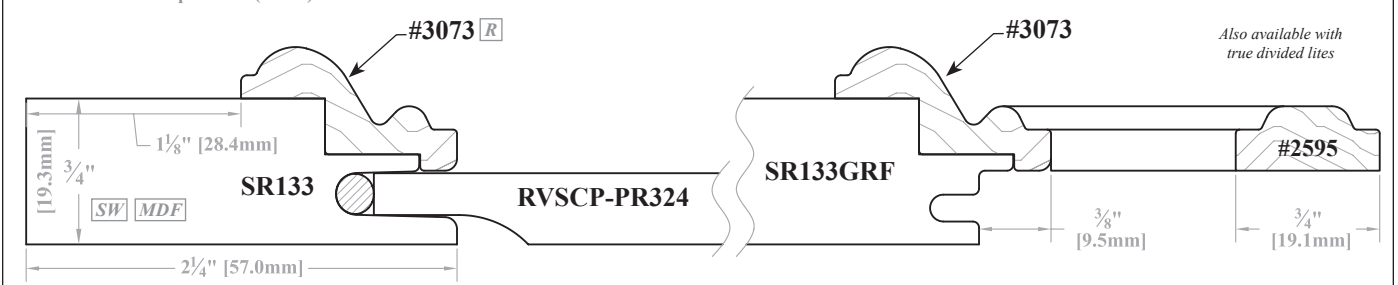

[SW] = Available in Solid Wood. [C] = Stile/Rail & Applied Molding combo shown are available Convex/Concave [AS] = Available on Adventure Series Doors.
 [R] = Available radiused to follow contour of shaped rails. [MDF] = Stile/Rail profile available on 5-piece MDF doors. Applied molding will be solid wood.

► For PRICING ► See Section E.5 in our current Wholesale Pricing Catalog.

Profile Options

Stile & Rail - Shelf Applied Molding

SR133 - Shelf Applied Molding Applications with Matching Mullion Stock - 3/4" [19.3mm] Thick Doors

PC: AM101
Multiplier: 1.0 (#3136)



SR155 - Shelf Applied Molding Applications with Matching Mullion Stock - 3/4" [19.1mm] Thick Doors

PC: AM102 Multiplier: .72 (#2405)



PC: AM101 Multiplier: .72 (#3164)

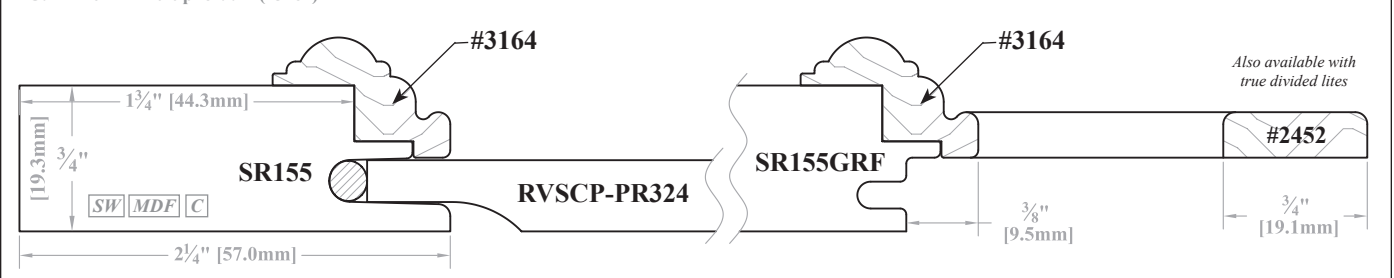

SW = Available in Solid Wood.

C = Stile/Rail & Applied Molding combo shown are available Convex/Concave

AS = Available on Adventure Series Doors.

R = Available radiused to follow contour of shaped rails.

MDF = Stile/Rail profile available on 5-piece MDF doors. Applied molding will be solid wood.

► For PRICING ► See Section [E.5](#) in our current Wholesale Pricing Catalog.

Stile & Rail - Shelf Applied Molding

Profile Options

"Old World" - Shelf Applied Molding Applications with Matching Mullion Stock - 1" [25.4mm] Thick Doors

PC: AM101 Multiplier: .72 (#3138)

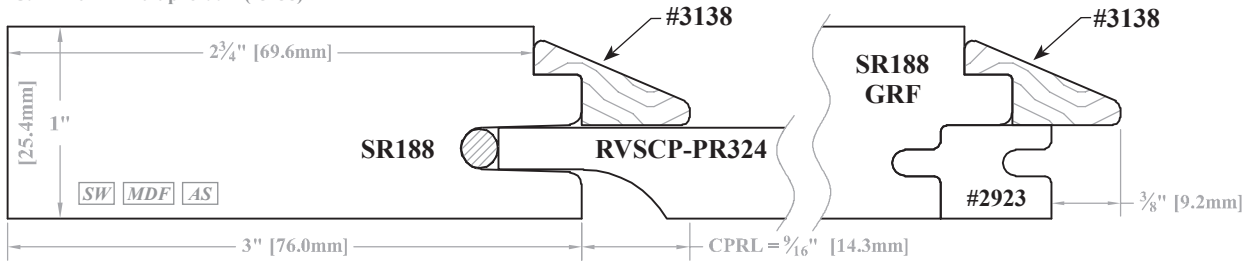

Matching Mullion Stock is *not* available

E

PC: AM101 Multiplier: .72 (#2753)

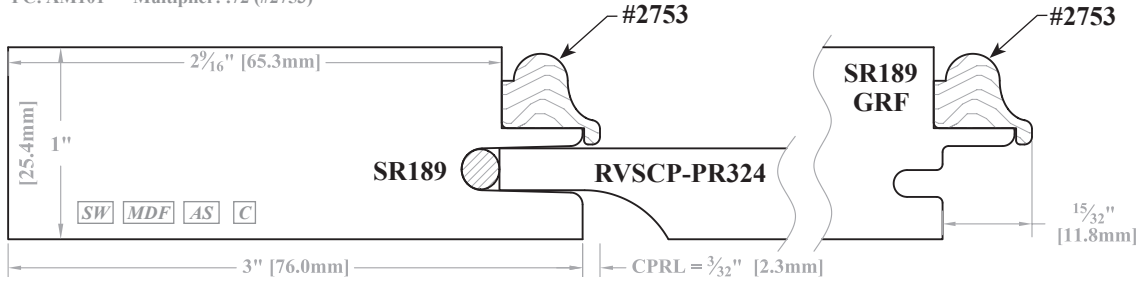

Matching Mullion Stock is *not* available

PC: AM101 Multiplier: 1.0 (#2936)
PC: AM101 Multiplier: .81 (#2924 - GRF Extension Molding)

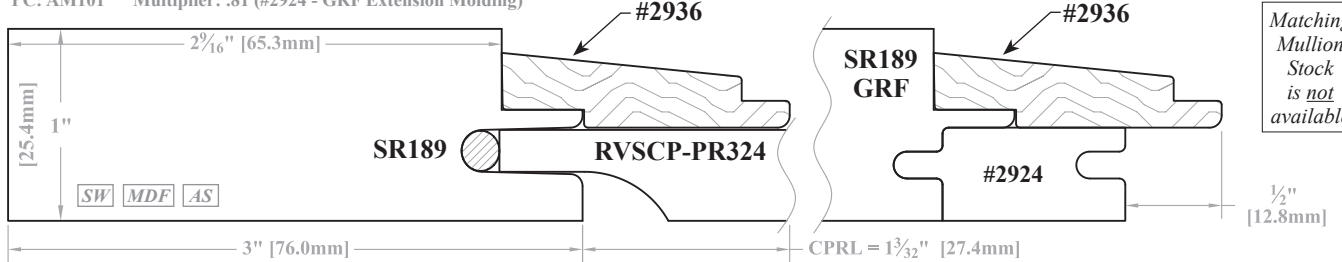

Matching Mullion Stock is *not* available

PC: AM101 Multiplier: .72 (#2979)

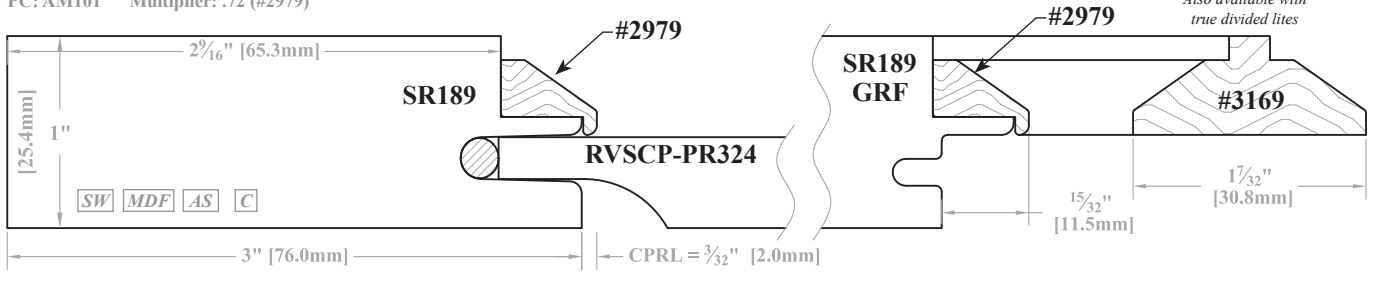

Also available with true divided lites

PC: AM102 Multiplier: .72 (#1880)

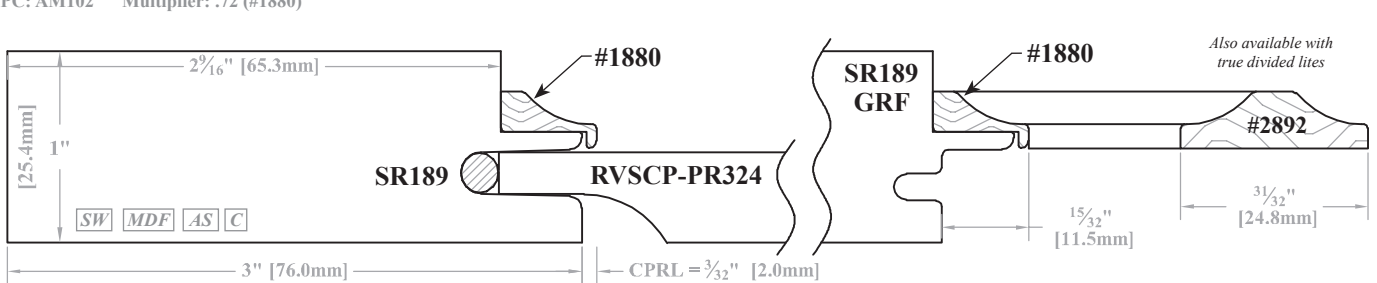

Also available with true divided lites

SW = Available in Solid Wood.

C = Stile/Rail & Applied Molding combo shown are available Convex/Concave

AS = Available on Adventure Series Doors.

R = Available radiused to follow contour of shaped rails.

MDF = Stile/Rail profile available on 5-piece MDF doors. Applied molding will be solid wood.

Profile Options

Stile & Rail - Shelf Applied Molding

"Old World" - Shelf Applied Molding Applications with Matching Mullion Stock - 1" [25.4mm] Thick Doors...continued

PC: AM101 Multiplier: .72 (#1372)

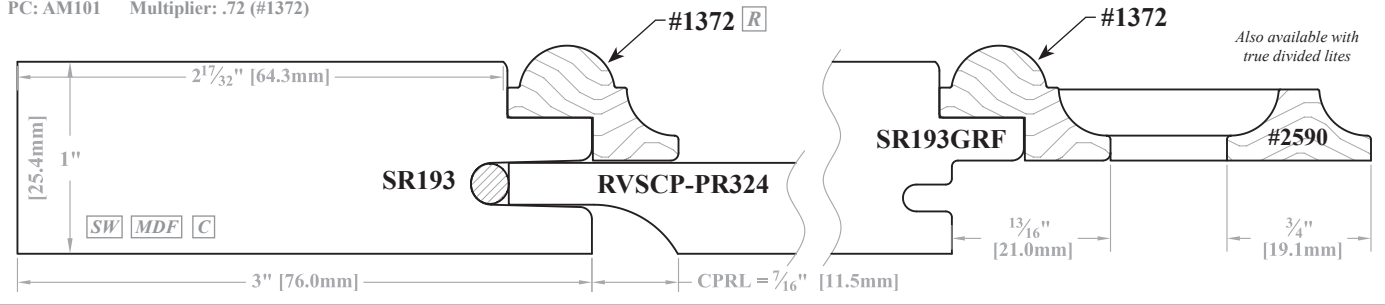

PC: AM101 Multiplier: .72 (#1729)
PC: AM101 Multiplier: .72 (#2923 - GRF Extension Molding)

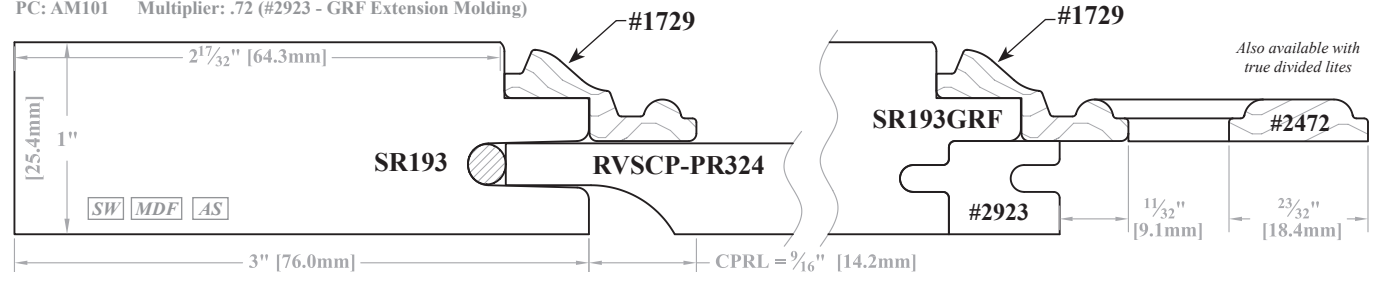

PC: AM101 Multiplier: .72 (#1831)
PC: AM101 Multiplier: .72 (#2923 - GRF Extension Molding)

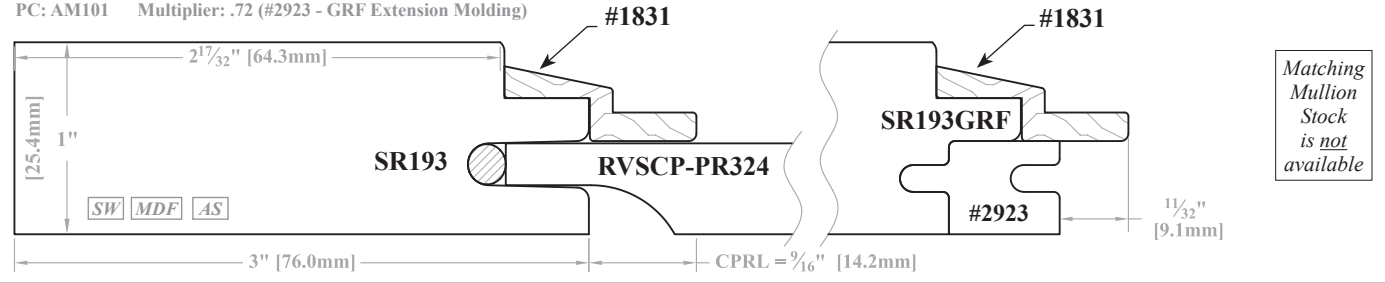

PC: AM101 Multiplier: .72 (#1908)

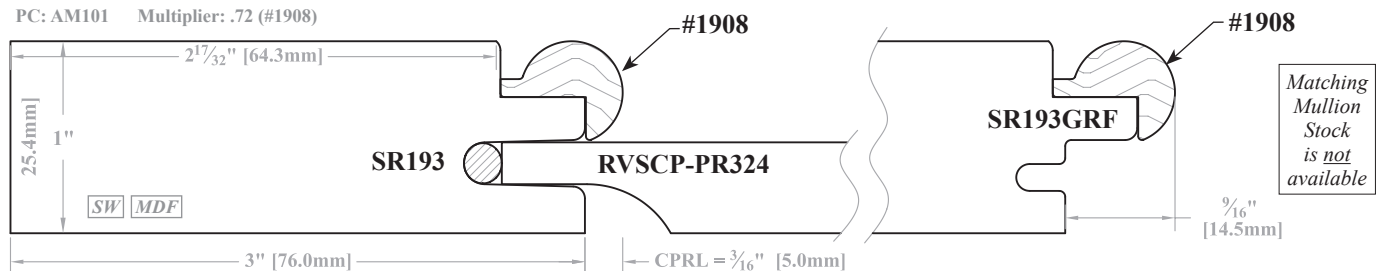

PC: AM101 Multiplier: .75 (#2403)

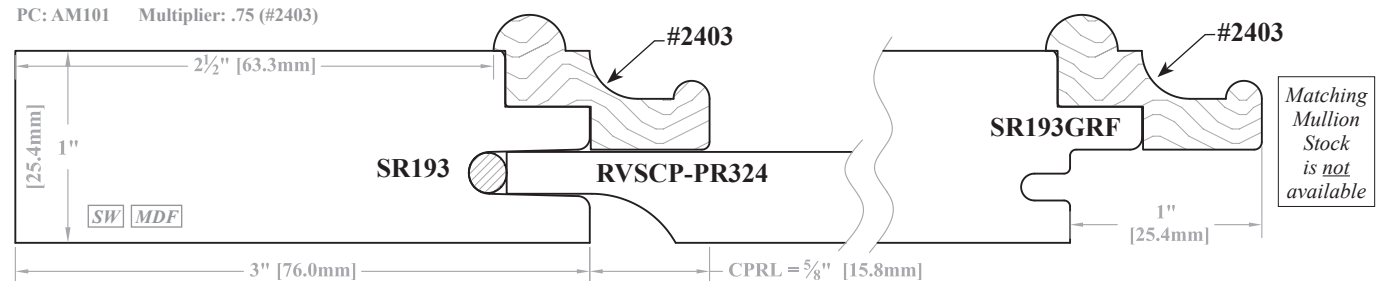

SW = Available in Solid Wood. C = Stile/Rail & Applied Molding combo shown are available Convex/Concave AS = Available on Adventure Series Doors.
R = Available radiused to follow contour of shaped rails. MDF = Stile/Rail profile available on 5-piece MDF doors. Applied molding will be solid wood.

► For PRICING ► See Section E.5 in our current Wholesale Pricing Catalog.

Center Panel Reveal Loss (CPRL)

When placing an applied molding on a door with a raised center panel, WalzCraft will not automatically adjust the center panel reveal.

- You must factor in the Center Panel Reveal Loss (CPRL) and plan accordingly.
- See examples below of how the center panel reveal is affected when adding an applied molding.

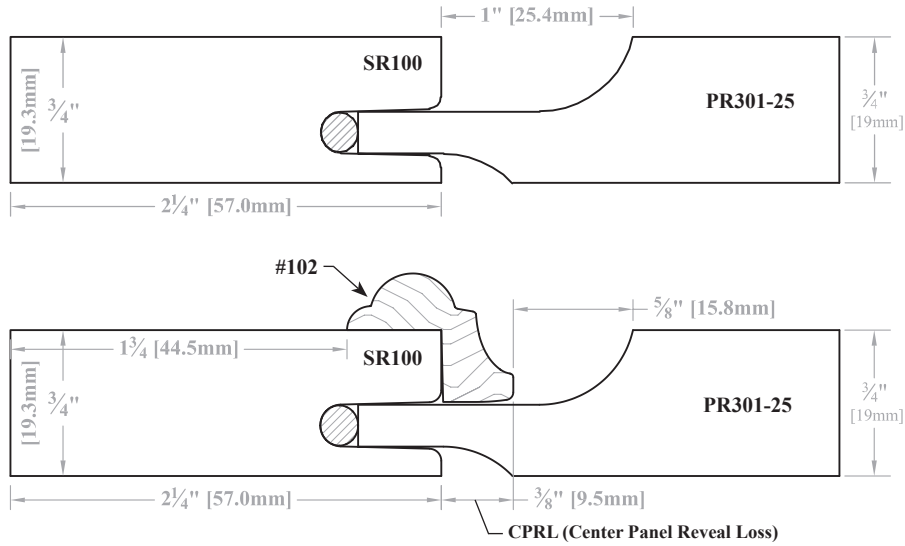

1" Center Panel Reveal (PR301-25) less 3/8" Center Panel Reveal Loss (CPRL) from applied molding #102 = 5/8".

E

► For PRICING ► See Section [E.5](#) in our current Wholesale Pricing Catalog.

Profile Options

Stile & Rail - Shelf Applied Molding

Ordering & Pricing Notes: Shelf Applied Molding Stile & Rail Profiles

Ordering Guidelines

1	Order Forms	Applicable order forms will include spaces to indicate your chosen profiles.
Pricing		
1	Pricing	Please see <i>Section E.5</i> and <i>E.8</i> of our current Wholesale Pricing Catalog .

Technical Notes: Shelf Applied Molding Stile & Rail Profiles

Cabinet Door & Drawer Front Options (Chapter B)

1	Doors w/ Square Rails	Raised or flat panel square doors, frames or wainscot panels using Traditional or Mitered stile and rail joinery are available with applied moldings.
2	Doors w/ Angled Stiles or Rails	Raised or flat panel angled doors, frames or wainscot panels using Traditional stile and rail joinery are available with applied moldings. Door Price Classes: 122, 126, 139, 140, 222, 226, 239, 240.
3	Doors w/ Shaped Rails	Raised or flat panel doors, frames or wainscot panels with one or more shaped rail, as well as quarter circle, half circle and Gothic doors and frames are available with applied moldings that follow the contour of the shaped rails. Not all applied moldings are available, please refer to <i>Molding Options</i> notes within this section. Some door styles may require additional customization which may be subject to additional design charges.
4	Applied Molding vs French Miter Construction	<u>R-FM</u> = Recommended French Miter. <ul style="list-style-type: none"> • Due to the nature of these profiles, in order to provide a better quality joint, WalzCraft recommends that they be ordered as French Miter construction (see <i>Section B.7</i> for more information on French Miter doors). • The French Miter joint represents a step up in quality and will provide a much cleaner look. • If choosing to order these R-FM profiles with French Miter construction, please use the matching French Miter door style along with the matching miter profile. • For example, if you want a Style 10 door with stile & rail profile SR122 w/ AM #1280, but made with French Miter construction, please order door style 10FM with mitered stile & rail profile MP604-57 (<i>Section E.9</i>). <ul style="list-style-type: none"> ◦ SR122 w/ AM #1280 matches MP604-57 ◦ SR155 w/ AM #2405 matches MP603-57 ◦ SR133 w/ AM #1664 matches MP668-57 ◦ SR133 w/ AM #3053 matches MP675-57 ◦ SR133 w/ AM #1717 matches MP659-57 ◦ SR122 w/ AM #1832 matches MP6118-57 ◦ SR135 w/ AM #1721 matches MP600-57 ◦ SR136 w/ AM #1880 matches MP6119-57 ◦ SR135 w/ AM #1722 matches MP602-57 ◦ SR154 w/ AM #2381 matches MP6120-57 ◦ SR136 w/ AM #1746 matches MP601-57 ◦ SR160 w/ AM #2528 matches MP6121-57 ◦ SR135 w/ AM #2053 matches MP6106-57 ◦ SR136 w/ AM #2690 matches MP6122-57
5	Adventure Series	<u>AS</u> = Stile & Rail and Shelf Applied molding combination are available for Adventure Series doors.

Convex/Concave Options (Chapter D)

1	Curved Products	<u>C</u> = Indicates that the stile/rail profile and applied molding and/or GRF extension molding combinations shown are available for convex/concave applications. See <i>Chapter D</i> for more information on convex/concave products.
---	-----------------	--

General Information (Chapter A)

1	Ready to Assemble (RTA)	Doors and drawer fronts with applied molding are not available Ready to Assemble (RTA).
---	-------------------------	---

Material Options

1	Material Options	<u>SW</u> = Stile/rail profile available on products made from solid wood. <u>MDF</u> = Stile/rail profile available on 5-piece MDF doors. Applied molding will be solid wood.
---	------------------	---

Miscellaneous

1	Application Method	<i>Most</i> applied moldings are glued and press fit. Small headless pins may be necessary for some applications. If used, these tiny pin holes will not be filled with putty.
---	--------------------	---

Molding Options (Chapter N)

1	GRF Extension Moldings	Some applied moldings require an additional GRF extension molding when frame & mullion doors are ordered. For door styles with a shaped rail or rails (ie: style 2000), the rail will be routed to follow the contour of the shape, thereby requiring the glass to be cut to follow the contour of the shape also.
2	Radius Molding	<u>R</u> = Indicates applied moldings, mullion stock moldings (when used as applied moldings) and GRF extension moldings can be radiused to follow the contour of a shaped rail (ie: arched top rail of door style 2000). Note, these options are not to be confused with options available for lite patterns. Stile & rail profile/mullion stock availability for lite pattern options can be found on our website: Resources/Technical Information .

Continued on next page...

► For **PRICING** ► See *Section E.5* in our current Wholesale Pricing Catalog.



Technical Notes: Shelf Applied Molding Stile & Rail Profiles

Profile Options (Chapter E)

1	Compatibility	See our website: Resources / Technical Information for Applied Molding / Center Panel Compatibility Charts to ensure that the molding and panel profile you have selected are compatible. When using a veneered flat or RVSCP-PR324 (Reversed Solid Center Panel) , we suggest allowing 1" [25.4mm] of visible flat surface on the center panel to allow for attaching hardware. See our website: Resources/Technical Information site for Applied Molding S/R & Mitered Profile Compatibility charts.
2	SR133, SR155	Only available with Applied Molding. All standard Center Panel profile reveals are compatible with the applied moldings designed for the SR133 and SR155 shelf.
3	SR144	SR144 is a Mirror Joint. See Section E.2 for more information.

Sizes/Dimensions

1	Application Drawings	The application drawings shown throughout Sections E.4, E.5 and E.6 can utilize either Traditional or Old World Joinery. Traditional Stile & Rail profiles are standard at 2¼" [57.2mm] wide and Old World are standard at 3" [76.2mm] wide. Drawings are to scale. The amount of visible flat space on the stile/rail, after the molding is applied, will vary depending on the Outside Edge Profile that is selected.
2	Applied Molding on Center Stiles and / or Center Rails	When ordering an applied molding profile on a door stile with a center stile or center rail, the visible distance for the flat surface on the center stile/rail will be less than that of the outside stile / rail, given that the applied molding would be affixed to both sides of the center stile/rail. WalzCraft does not automatically modify the width of the center stile / rail to compensate for this. The minimum distance for the flat surface between moldings for any center stile or center rail with shelf applied molding is 1" [25.4mm].

Wood Specie Options (Chapter S)

1	Wood Species and Grade	When ordering applied moldings, the applied molding will match the wood species and grade of the door unless otherwise noted. Wood species may be limited. See Section E.8 in our current Wholesale Pricing Catalog for availability. If an applied molding is Quarter Sawn, Rift Sawn (Straight Grain) or (Straight Grain), WalzCraft will attempt to match the grain on the face of the molding to the grain on the face of the product (ie: door or drawer front). However, it should be expected that Quarter Sawn grain will have some amount of Rift Sawn character, and Rift Sawn grain will have some amount of Quarter Sawn character. This is especially true when moldings have deep profiles.
2	MDF Stiles/Rails with Solid Wood Applied Molding	When stiles/rails are MDF, the applied molding will be made from one of the following: <ul style="list-style-type: none"> • Maple-Hard/Soft-Mixed-Value/Budget/Paint Grade • Birch-Value/Budget/Paint Grade • Poplar-Value/Budget/Paint Grade.

Stile & Rail - Shelf Applied Molding - END

► For PRICING ► See Section E.5 in our current Wholesale Pricing Catalog.

E

Profile Options

Stile & Rail - Face Applied Molding

Face Applied Molding Applications

PC: AM101
Multiplier: 1.04
(#103)

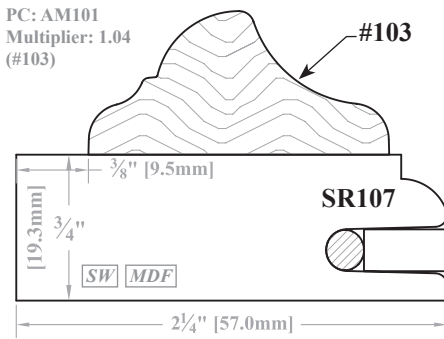

* To allow adequate space to apply an Outside Edge Profile, we recommend you order Stiles & Rails wider than 2 1/4". Please refer to our website Technical Information for Profile Reveal Widths.

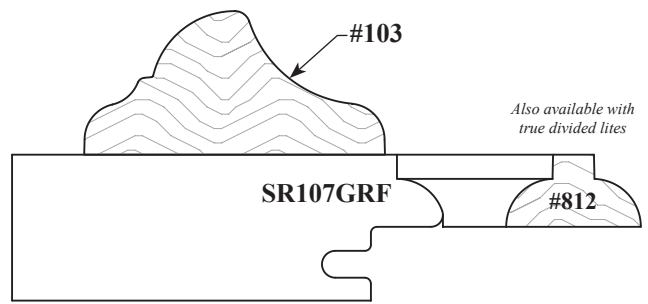

PC: AM101 Multiplier: 1.25 (#805)

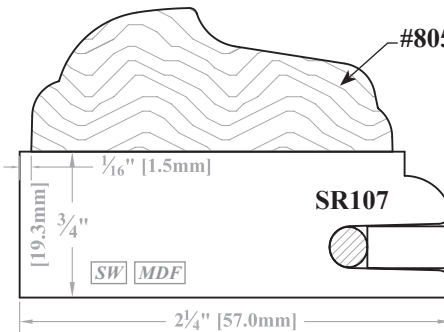

* To allow adequate space to apply an Outside Edge Profile, we recommend you order Stiles & Rails wider than 2 1/4". Please refer to our website Technical Information for Profile Reveal Widths.

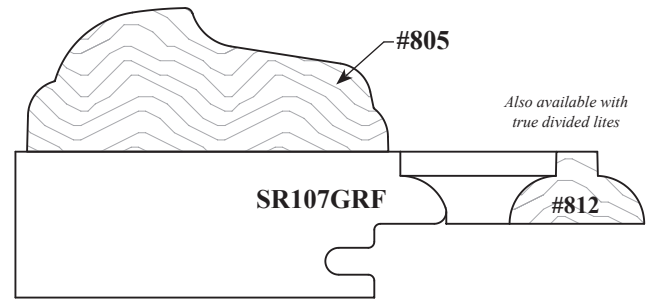

PC: AM101 Multiplier: .72 (#1234)

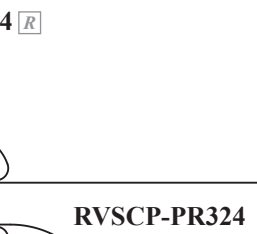
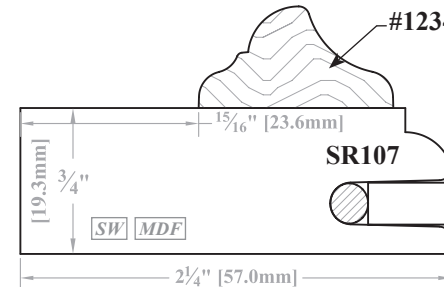

PC: AM101 Multiplier: .75 (#806)

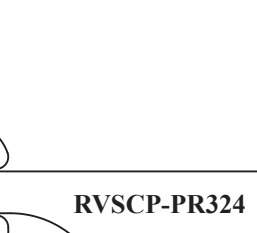
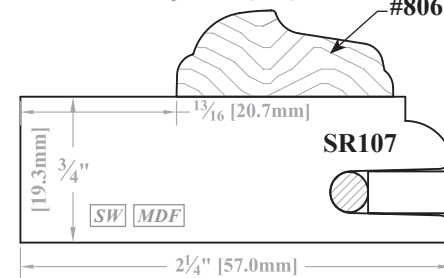

PC: AM102 Multiplier: .72 (#238)

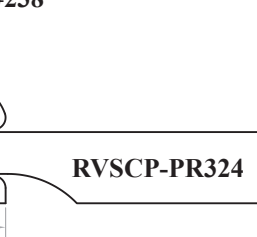
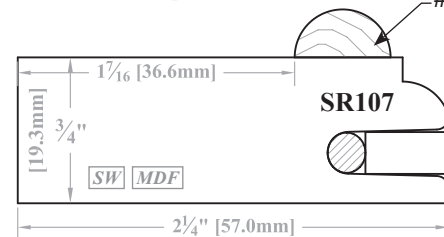

SW = Available in Solid Wood.

C = Stile / Rail & Applied Molding combo shown are available Convex / Concave

R = Available radiused to follow contour of shaped rails.

MDF = Stile / Rail profile available on 5-piece MDF doors. Applied molding will be solid wood.

Face Applied Molding Applications

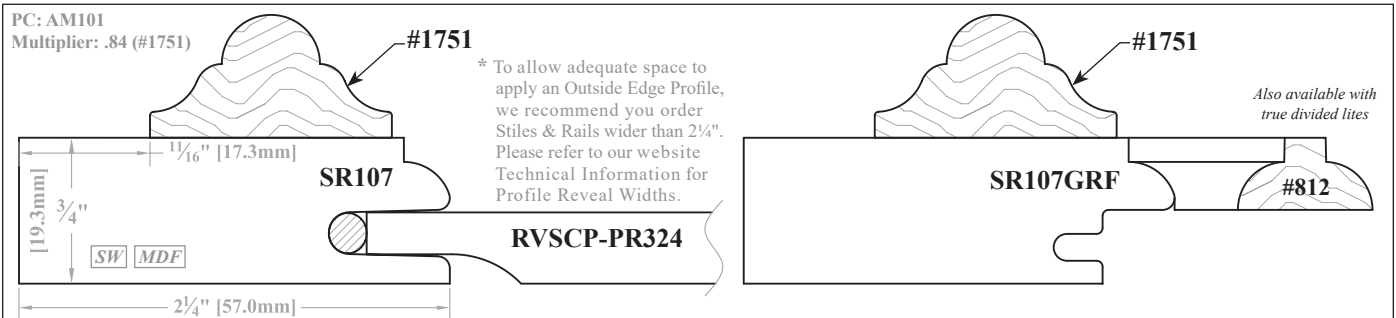
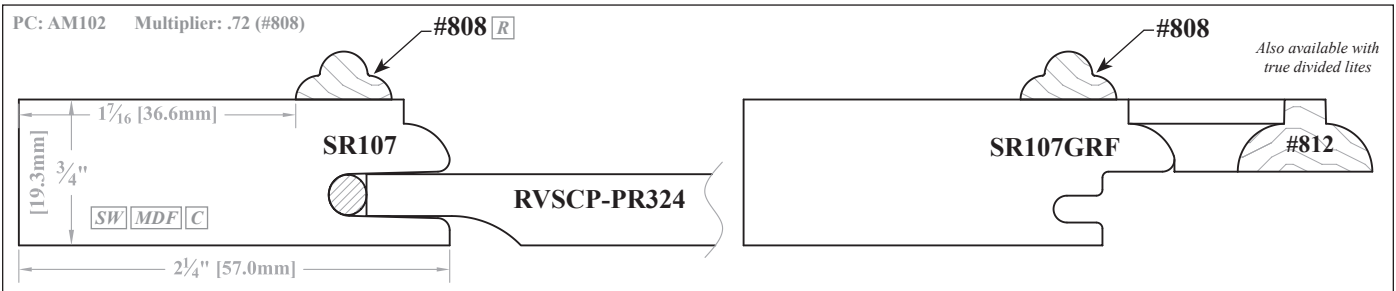
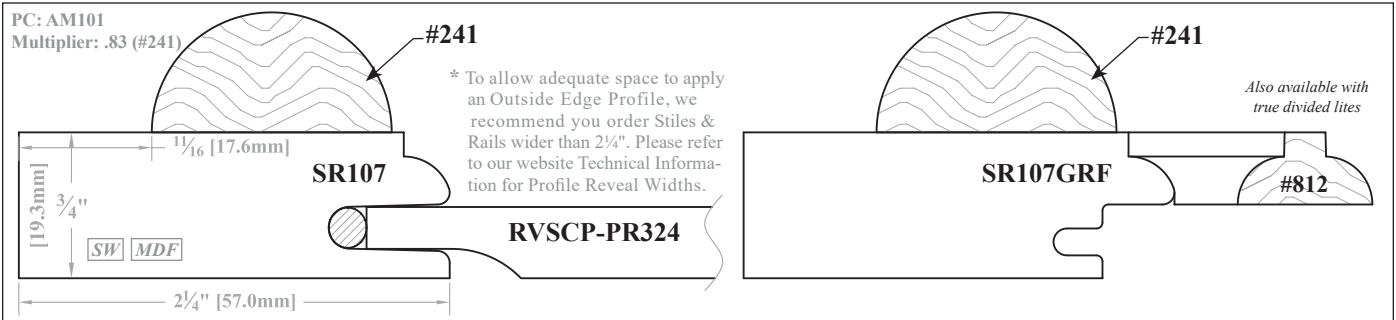
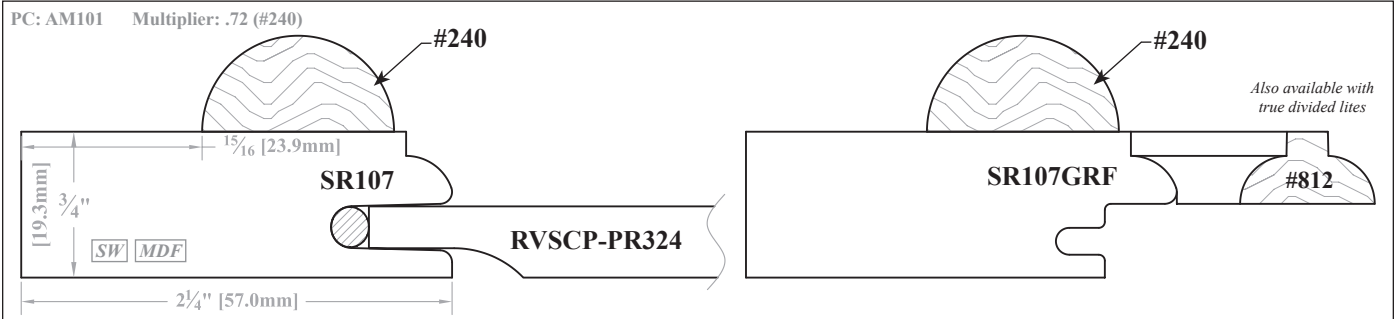
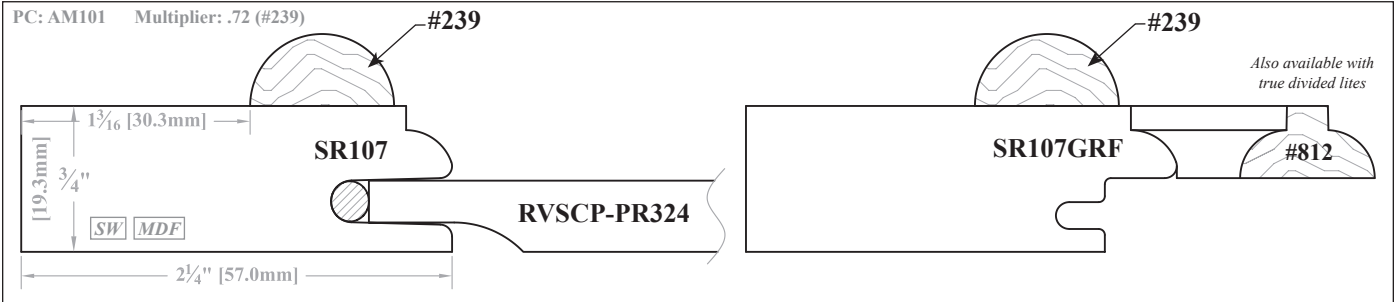

[SW] = Available in Solid Wood. [C] = Stile/Rail & Applied Molding combo shown are available Convex/Concave
 [R] = Available radiused to follow contour of shaped rails. [MDF] = Stile / Rail profile available on 5-piece MDF doors. Applied molding will be solid wood.

► For PRICING ► See Section E.6 in our current Wholesale Pricing Catalog.

Profile Options

Stile & Rail - Face Applied Molding

Face Applied Molding Applications

PC: AM101 Multiplier: .72 (#922)

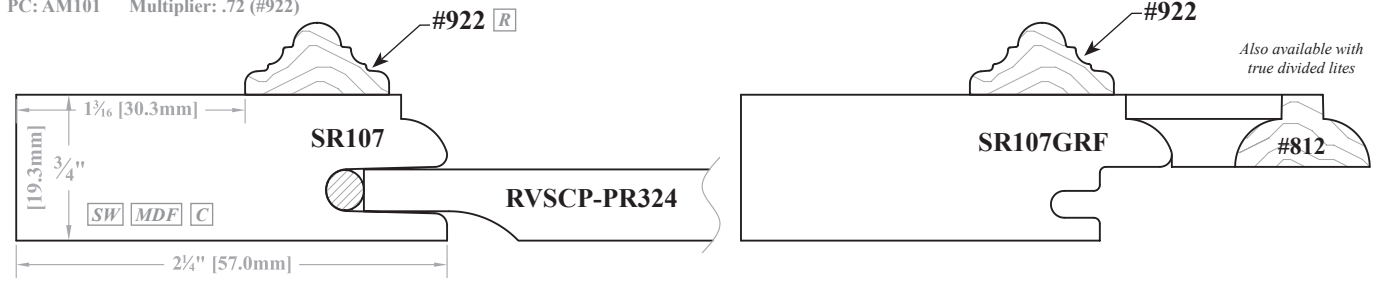

PC: AM102 Multiplier: .72 (#831)

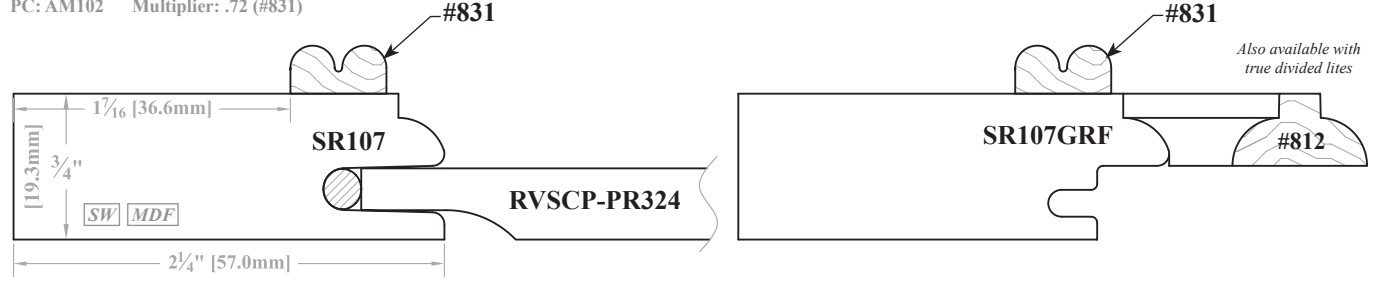

PC: AM102 Multiplier: .72 (#1693)

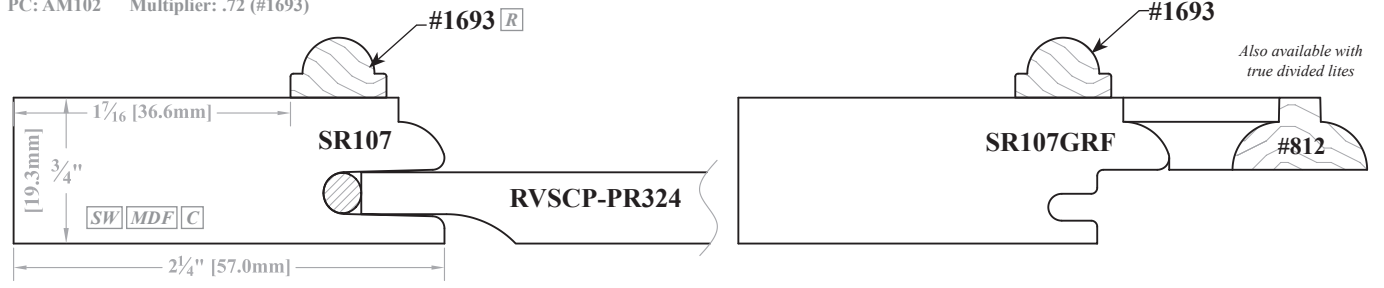

PC: AM102 Multiplier: .72 (#1694)

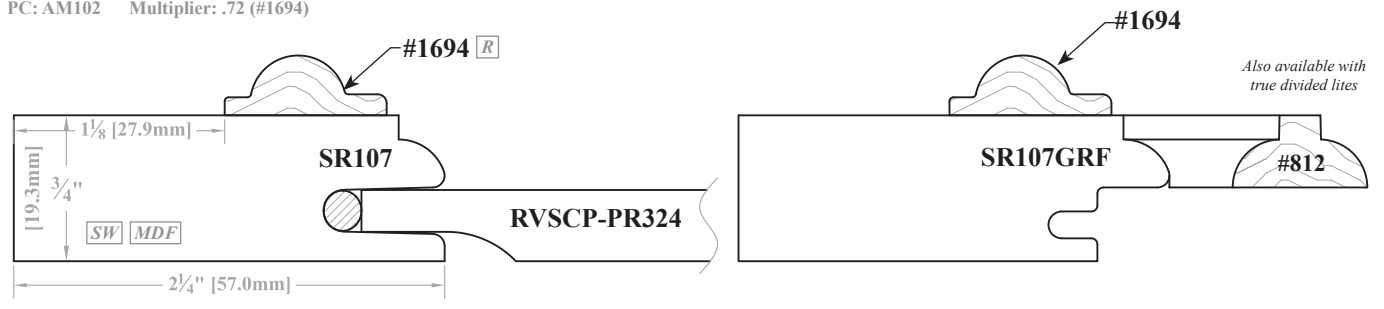

PC: AM102 Multiplier: .72 (#1043)

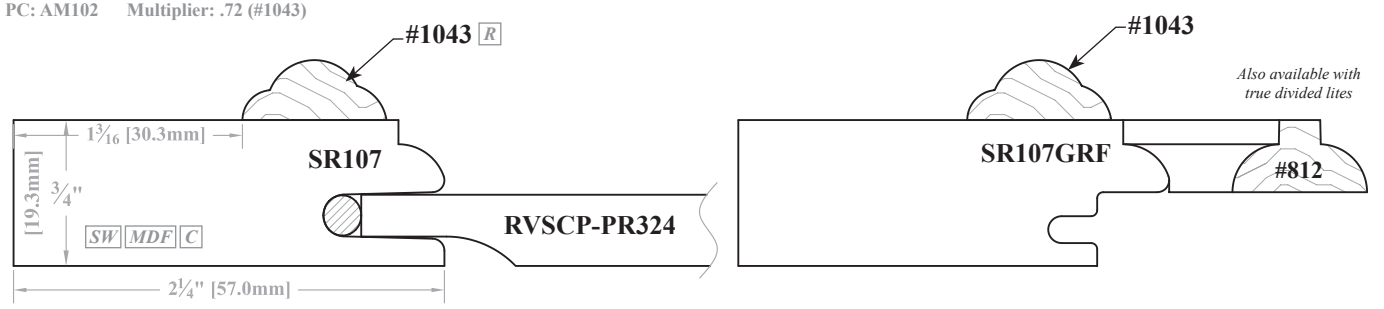

SW = Available in Solid Wood.

C = Stile/Rail & Applied Molding combo shown are available Convex/Concave

R = Available radiused to follow contour of shaped rails.

MDF = Stile / Rail profile available on 5-piece MDF doors. Applied molding will be solid wood.

► For PRICING ► See Section E.6 in our current Wholesale Pricing Catalog.

Face Applied Molding Applications

PC: AM101 Multiplier: .83 (#1350)

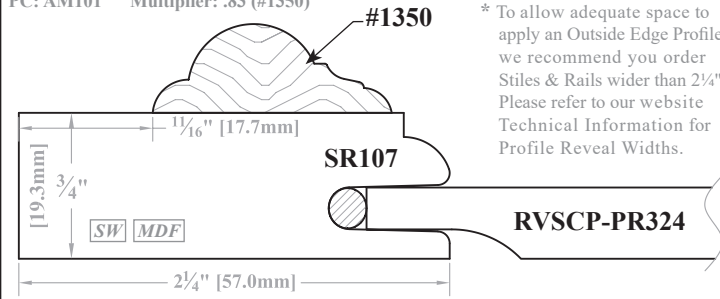

* To allow adequate space to apply an Outside Edge Profile, we recommend you order Stiles & Rails wider than 2 1/4". Please refer to our website Technical Information for Profile Reveal Widths.

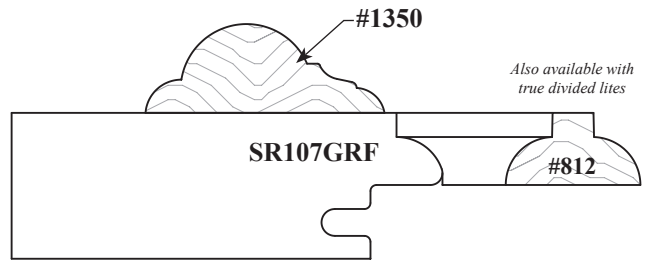

PC: AM101 Multiplier: .72 (#818)

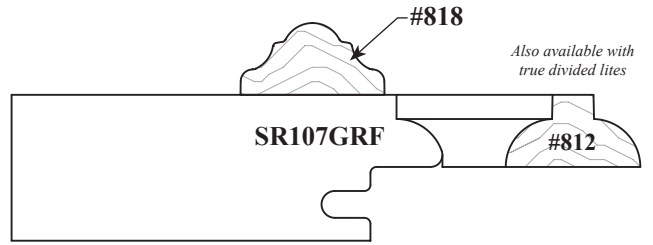
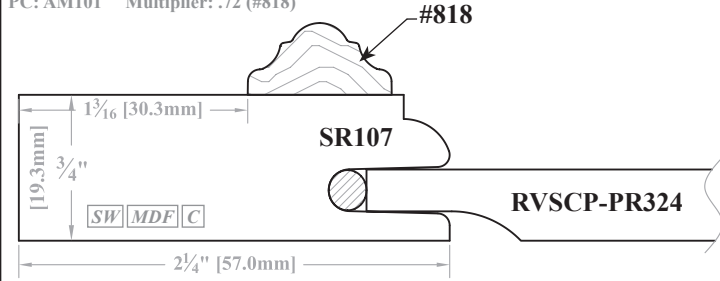

PC: AM102 Multiplier: .72 (#1815)

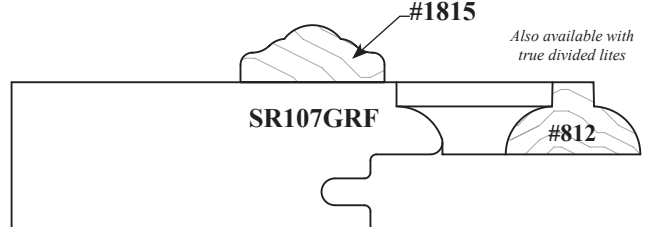
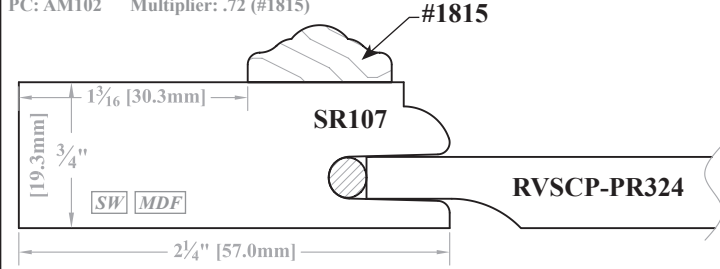

PC: AM101 Multiplier: .72 (#1874)

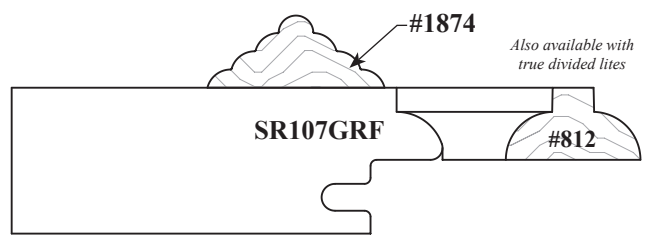
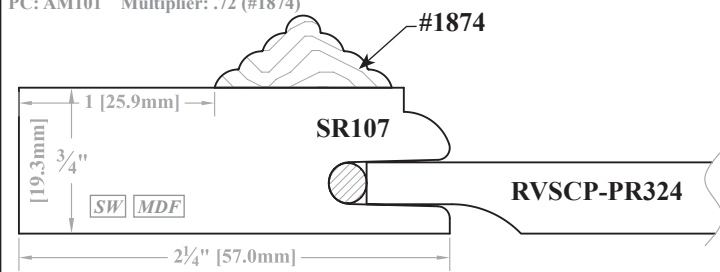

PC: AM102 Multiplier: .72 (#2075)

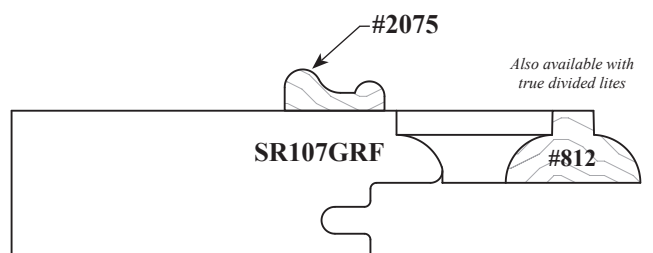
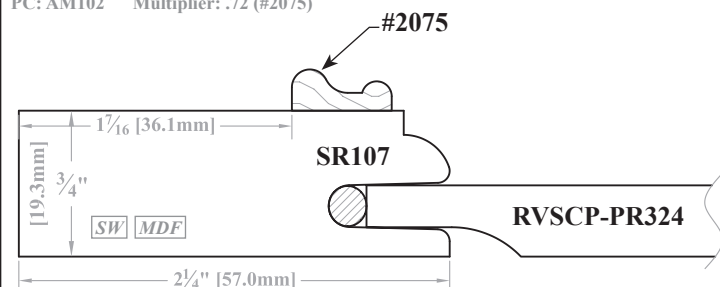

SW = Available in Solid Wood.

C = Stile/Rail & Applied Molding combo shown are available Convex/Concave

R = Available radiused to follow contour of shaped rails.

MDF = Stile / Rail profile available on 5-piece MDF doors. Applied molding will be solid wood.

► For PRICING ► See Section E.6 in our current Wholesale Pricing Catalog.

Face Applied Molding Applications

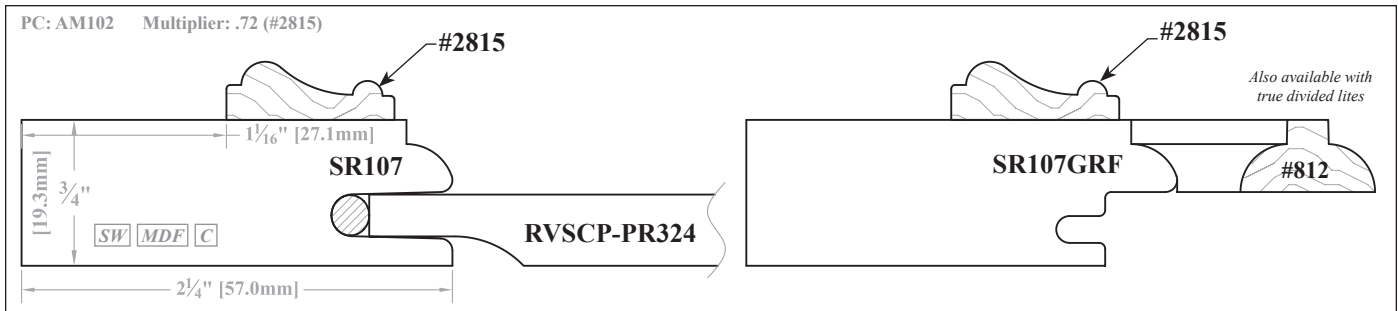
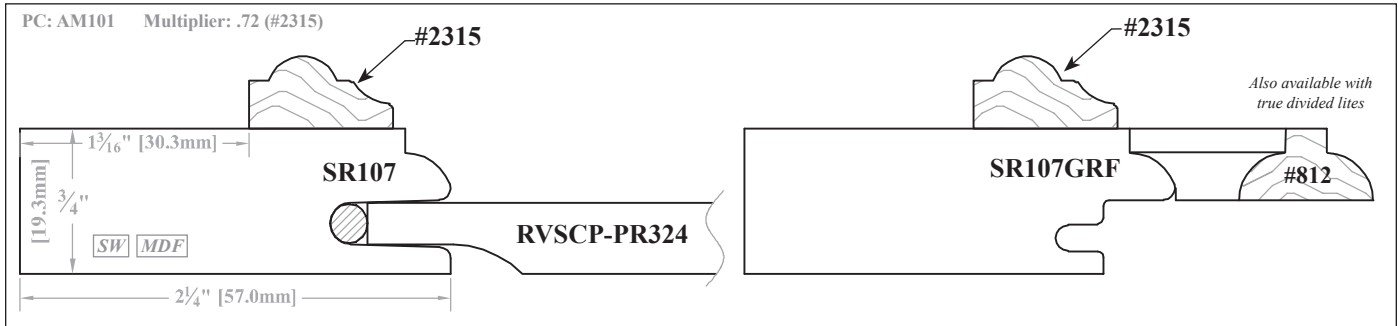
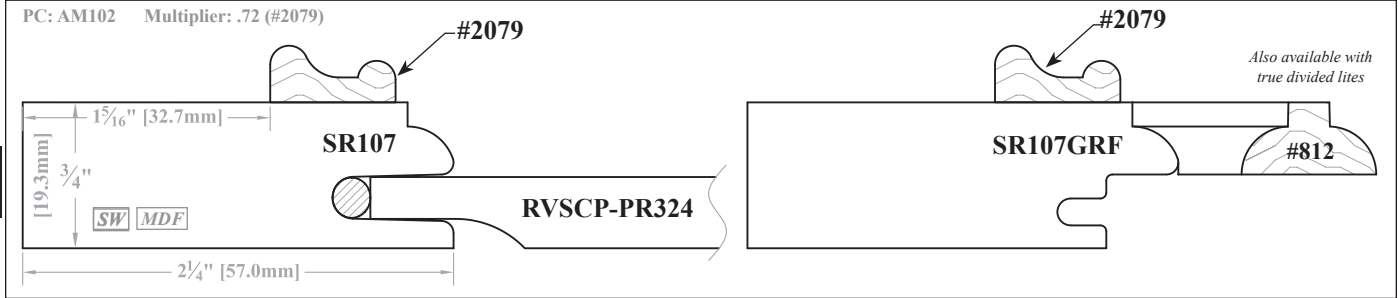

SW = Available in Solid Wood. **C** = Stile/Rail & Applied Molding combo shown are available Convex/Concave
R = Available radiused to follow contour of shaped rails. **MDF** = Stile / Rail profile available on 5-piece MDF doors. Applied molding will be solid wood.

Ordering & Pricing Notes: Stile & Rail - Face Applied Molding

Ordering Guidelines

1	Order Forms	Applicable order forms will include spaces to indicate your chosen profiles.
Pricing		
1	Pricing	Please see <i>Section E.6</i> and <i>E.8</i> of our current Wholesale Pricing Catalog.

Technical Notes: Stile & Rail - Face Applied Molding

Cabinet Door & Drawer Front Options (Chapter B)

1	Doors w/ Square Rails	Raised or flat panel square doors, frames or wainscot panels using Traditional or Mitered stile and rail joinery are available with applied moldings.
2	Doors w/ Angled Stiles or Rails	Raised or flat panel angled doors, frames or wainscot panels using Traditional stile and rail joinery are available with applied moldings. Door Price Classes: 122, 126, 139, 140, 222, 226, 239, 240.
3	Doors w/ Shaped Rails	Raised or flat panel doors, frames or wainscot panels with one or more shaped rail, as well as quarter circle, half circle and Gothic doors and frames are available with applied moldings that follow the contour of the shaped rails. Not all applied moldings are available, please refer to <i>Molding Options</i> notes within this section. Some door styles may require additional customization which may be subject to additional design charges.

Continued on next page...

► For PRICING ► See Section E.6 in our current Wholesale Pricing Catalog.

Technical Notes: Stile & Rail - Face Applied Molding...continued

Convex/Concave Options (Chapter D)

1	Curved Products	☐ = Indicates that the stile & rail profile and applied molding and/or GRF extension molding combinations shown are available for Convex/Concave applications. See Chapter D for more information on Convex/Concave products.
---	-----------------	--

General Information (Chapter A)

1	Ready to Assemble (RTA)	Doors and drawer fronts with applied molding are not available Ready to Assemble (RTA).
---	-------------------------	---

Material Options

1	Material Options	<p>☐^{SW} = Stile & rail profile available on products made from solid wood.</p> <p>☐^{MDF} = Stile & rail profile available on 5-piece MDF doors. Applied molding will be solid wood.</p>
---	------------------	--

Miscellaneous

1	Application Method	Most applied moldings are glued and press fit. Small headless pins may be necessary for some applications. If used, these tiny pin holes will not be filled with putty.
---	--------------------	---

Molding Options (Chapter N)

1	GRF Extension Moldings	Some applied moldings require an additional GRF extension molding when frame & mullion doors are ordered.
2	Radius Molding	<p>☐^R = Indicates applied moldings, mullion stock moldings (when used as applied moldings) and GRF extension moldings can be radiused to follow the contour of a shaped rail (ie: arched top rail of door style 2000).</p> <p>Note, these options are not to be confused with options available for lite patterns. Stile & rail profile/mullion stock availability for lite pattern options can be found on our website.</p>
3	Multiple Applied Moldings	You may use more than one applied molding on a door or drawer front. Each applied molding would be priced using the lineal inch price for that molding, in addition to joint charges for each molding. Contact our Customer Support Team for questions.

Profile Options (Chapter E)

1	Compatibility	<p>See our website, Resources/Technical Information for Applied Molding/Centers Panel Caompatibility charts to ensure that the molding and panel profile you have selected are compatible. When using a veneered flat or RVSCP-PR324 (Reversed Solid Center Panel), we suggest allowing 1" [25.4mm] of visible flat surface on the center panel to allow for attaching hardware.</p> <p>See our website, Resources/Forms & Information/Technical Information site for Applied Molding S/R & Mitered Profile Compatibility charts.</p>
---	---------------	--

Sizes/Dimensions

1	Application Drawings	<p>The application drawings shown throughout Sections E.4, E.5 and E.6 can utilize either Traditional or Old World joinery. Traditional stile & rail profiles are standard at 2 1/4" [57.2mm] wide and Old World are standard at 3" [76.2mm] wide. Drawings are shown at full scale.</p> <p>The dimension on the face after the molding is applied will vary, depending on the outside edge profile that is selected.</p>
2	Applied Molding on Center Stiles and / or Center Rails	When ordering an applied molding profile on a door style with a center stile or center rail, the amount of visible flat space on the center stile/rail will be less than that of the outside stiles and rails. WalzCraft will not automatically modify the width of the center stile/rail to compensate for this.
3	Positioning	Face applied moldings are set back 1/16" [1.6mm] from the Stile and Rail profile. Custom placements are available but may be subject to additional design charges .

Wood Specie Options (Chapter S)

1	Wood Species and Grade	<p>When ordering applied moldings, the applied molding will match the wood species and grade of the door unless otherwise noted.</p> <p>Wood species may be limited. See Section E.8 in our current Wholesale Pricing Catalog for availability.</p> <p>If an applied molding is Quarter Sawn, Rift Sawn (Straight Grain) or (Straight Grain), WalzCraft will attempt to match the grain on the face of the molding to the grain on the face of the product (ie: door or drawer front). However, it should be expected that Quarter Sawn grain will have some amount of Rift Sawn character, and Rift Sawn grain will have some amount of Quarter Sawn character. This is especially true when moldings have deep profiles.</p>
2	MDF Stiles/Rails with Solid Wood Applied Molding	<p>When stiles/rails are MDF, the applied molding will be made from one of the following:</p> <ul style="list-style-type: none"> • Maple-Hard/Soft-Mixed-Value/Budget/Paint Grade • Birch-Value/Budget/Paint Grade • Poplar-Value/Budget/Paint Grade.

Stile & Rail - Face Applied Molding - END

► For PRICING ► See Section **E.6** in our current Wholesale Pricing Catalog.

Face Applied Half Round Rope Moldings

See Outsourced Applied Moldings for Wood Species & Pricing.

**#810
Half Round Rope Molding**

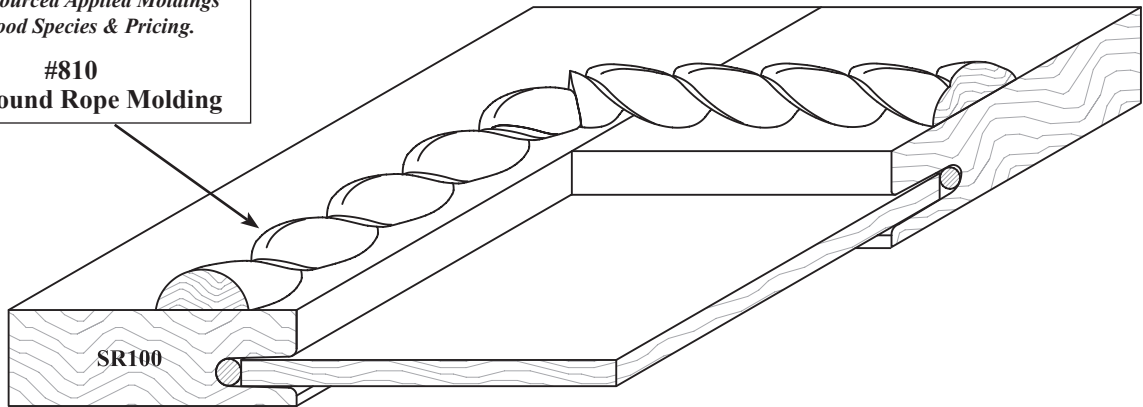

Ordering & Pricing Notes: Face Applied Half Round Rope Molding

Ordering Guidelines

1	Order Forms	Applicable order forms will include spaces to indicate your chosen profiles.
<i>Pricing</i>		
1	Pricing	Please see <i>Section E.6</i> and <i>E.8</i> of our current Wholesale Pricing Catalog .

Technical Notes: Face Applied Half Round Rope Molding

Molding Options (Chapter N)

1	Application	Shown above with half round rope molding #810 attached to the face of the stiles and rails. See <i>Section E.8</i> for additional molding options.
2	Corner Block Molding	Corner block molding is recommended with rope moldings where they meet at the corners to prevent mis-match that may occur. See <i>Section E.7</i> for corner blocks.

Sizes/Dimensions

1	Positioning	Face applied moldings are set back 1/16" [1.6mm] from the Stile and Rail profile. Custom placements are available but may be subject to <i>additional design charges</i> .
----------	--------------------	--

Wood Specie Options (Chapter S)

1	Wood Species and Grade	When ordering applied moldings, the applied molding will match the wood species and grade of the door unless otherwise noted. Wood species may be limited. See <i>Section E.8</i> in our current Wholesale Pricing Catalog for availability.
----------	-------------------------------	--

Stile & Rail - Face Applied Half Round Rope Molding - END

► **For PRICING** ► See *Section E.6* in our current Wholesale Pricing Catalog.

Built-In Shelf for Face Applied Molding on Mitered Stile & Rail Profiles

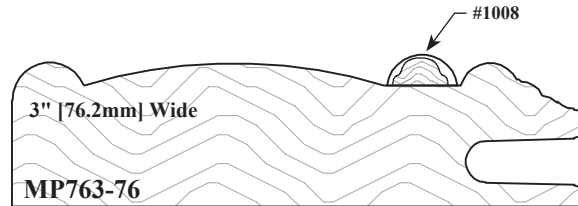
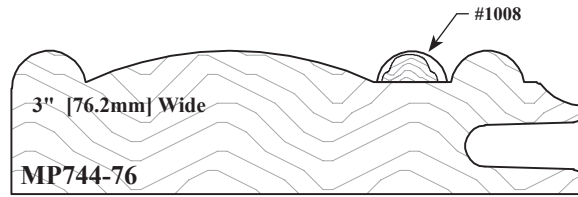

Ordering & Pricing Notes: Face Applied Molding and Built-In Shelf

Ordering Guidelines

1	Order Forms	Applicable order forms will include spaces to indicate your chosen profiles.
Pricing		
1	Pricing	Please see <i>Section E.6</i> and <i>E.8</i> of our current Wholesale Pricing Catalog .

Technical Notes: Face Applied Molding and Built-In Shelf

Molding Options (Chapter N)

1	Application	The Built-In Shelf will accept the #1008 applied molding, which is 3/8" [9.5mm] wide.
2	Corner Block Molding	Corner block molding is recommended with beaded and rope moldings where they meet at the corners to prevent mismatch that may occur. See <i>Section E.7</i> of our current Wholesale Pricing Catalog for Corner Blocks.

Profile Options (Chapter E)

1	Features	A built-in shelf that is an integral component of the mitered profile. The shelf allows you the option to add a 3/8" [9.5mm] applied molding.
2	Mitered Profiles	The following mitered profiles have the built-in shelf feature: • MP744-76, MP744-57, MP744-38, MP763-76, MP763-57, MP763-38.

Stile & Rail - Face Applied Molding and Built-In Shelf - END

► For PRICING ► See *Section E.6* in our current Wholesale Pricing Catalog.

E

Recessed Applied Molding (RAM) Rout Examples

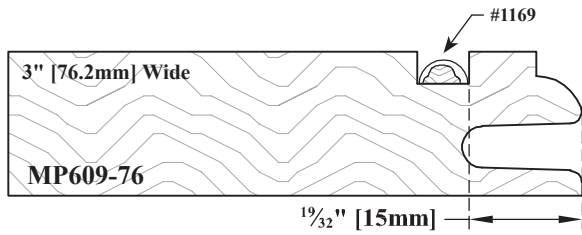
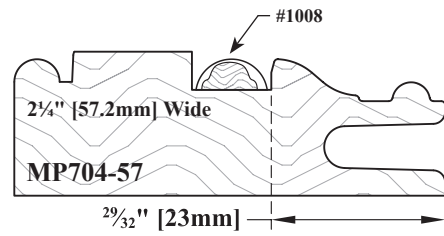
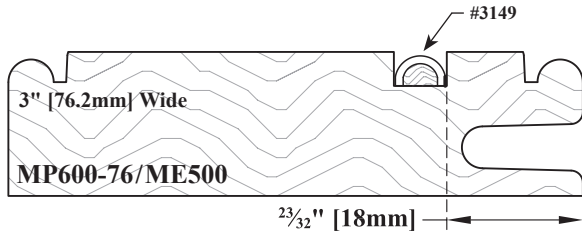
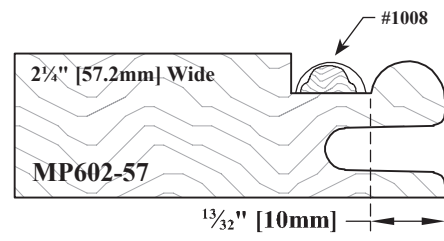
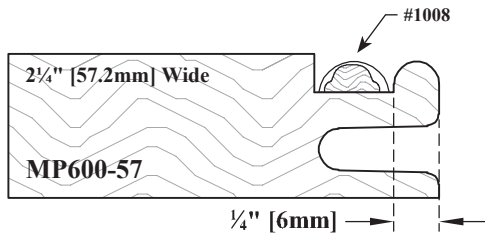

Continued on next page...

► For PRICING ► See Section E.6 in our current Wholesale Pricing Catalog.

Ordering & Pricing Notes: Recessed Applied Molding (RAM) Rout

Ordering Guidelines

1	Order Forms	Applicable order forms will include spaces to indicate your chosen profiles.
2	Ordering Information	<p>When ordering, please specify:</p> <ul style="list-style-type: none"> • Applied molding number. <ul style="list-style-type: none"> ◦ The molding will determine the width and depth of RAM rout. ◦ Limitations may apply based on these dimensions. • If applicable, the non-matching wood species for your molding. • RAM rout placement (see drawing below). <ul style="list-style-type: none"> ◦ This is the distance from the inside edge of the stile & rail to the edge of the RAM rout (1/4" [6.4mm] minimum). ◦ Limitations may apply based on the width of the mitered profile, width of molding, and width of OSE profile. <div style="text-align: center;"> </div>

Pricing

1	Pricing	Please see <i>Section E.6</i> and <i>E.8</i> of our current Wholesale Pricing Catalog .
---	----------------	--

Technical Notes: Recessed Applied Molding (RAM) Rout

Cabinet Door & Drawer Front Options (Chapter B)

1	Door Styles	RAM Routs are only available with Mitered mortise & tenon constructed doors from <i>Sections B.5</i> and <i>B.6</i> .
---	--------------------	---

Molding Options (Chapter N)

1	Corner Block Molding	Corner block molding is recommended with beaded and rope moldings where they meet at the corners to prevent mismatch that may occur. See <i>Section E.7</i> of our current Wholesale Pricing Catalog for Corner Blocks.
---	-----------------------------	--

Profile Options (Chapter E)

1	Description	<p>A Recessed Applied Molding (RAM) rout is a recessed groove that is added to the design of a mitered profile.</p> <p>The RAM rout is set back from the inside edge of the mitered stile & rail profile and allows you to insert an applied molding into the RAM rout.</p> <ul style="list-style-type: none"> • This set back is referred to as the RAM rout placement (minimum placement of 1/4" [6.4mm]).
2	Mitered Profiles	RAM routs are only available with mitered profiles from <i>Sections E.9</i> , <i>E.10</i> , and <i>E.11</i> .
3	Minimum Flat Space	The amount of visible flat space on the stile/rail, after the molding is applied, will vary depending on the outside edge profile that is selected (minimum flat space of 1/4" [6.4mm]).
4	Convex/Concave	<p>RAM Routs are available on convex products only. Not available concave. Additional charges will apply.</p> <ul style="list-style-type: none"> • See <i>Section E.9</i> and <i>Section E.10</i> for Convex/Concave compatible miter profiles. • See <i>Section N.5</i> and <i>Section N.13</i> for Convex/Concave compatible applied molding.

Stile & Rail - Face Applied Molding - RAM Rout - END

► For PRICING ► See *Section E.6* in our current Wholesale Pricing Catalog.

"Corner Block" Molding Application Drawing - #1217

E

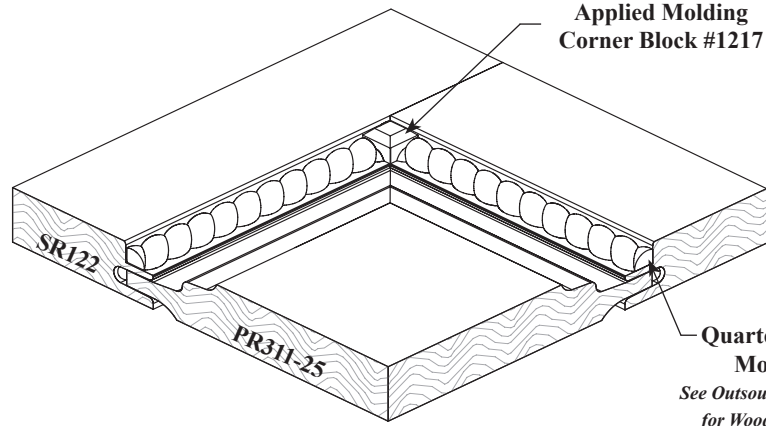
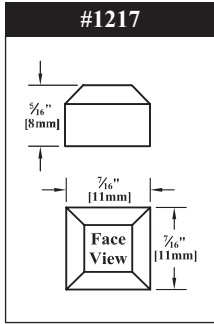

Quarter Round Rope Molding #1216
See Outsourced Applied Moldings for Wood Species & Pricing.

"Corner Block" Molding Application Drawing - #2221

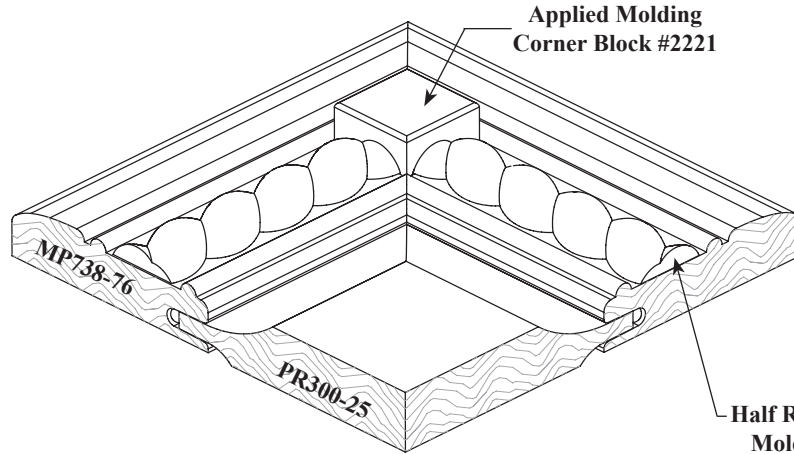
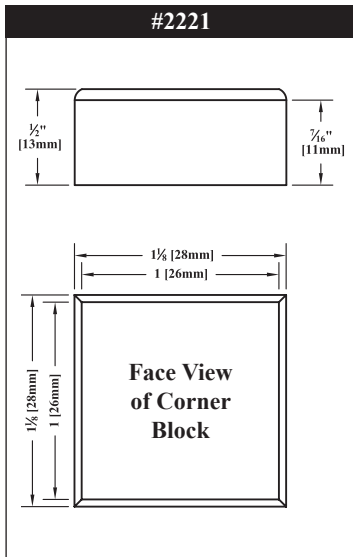

Half Round Rope Molding #811
See Outsourced Applied Moldings for Wood Species & Pricing.

Continued on next page...

► For PRICING ► See Section E.7 in our current Wholesale Pricing Catalog.

Ordering & Pricing Notes: Corner Blocks

Ordering Guidelines

1	Order Forms	Please use <i>Door and/or Drawer Front Order Forms (E•Z Forms #2 and #3)</i> .
Pricing		
1	Pricing	Please see <i>Section E.7</i> of our current Wholesale Pricing Catalog .

Technical Notes: Corner Blocks

Molding Options (Chapter N)

1	Corner Block Molding	Corner block molding is recommended with beaded and rope moldings where they meet at the corners to prevent mismatch that may occur.
---	----------------------	--

Profile Options (Chapter E)

1	Mitered Profiles with a Built-In Shelf	These mitered profiles accommodate the built-in shelf feature: MP744-76, MP744-57, MP744-38, MP763-76, MP763-57 and MP763-38 .
		These mitered profiles will accept the #1008, #1168 and #1169 rope molding. <ul style="list-style-type: none"> • #1168 and #1169 rope moldings will have flat spots on both sides of the corner block due to the width of these moldings.
2	Applied Molding Shelf	The type of construction shown is only available when used with: SR122, SR136, SR193, MP625-76, MP625-57, MP625-38, MP759-76, MP759-57, MP759-38 .
		These profiles work best with the #951, #1008 and #1216 moldings.

Wood Specie Options (Chapter S)

1	Wood Species	Corner Blocks are available in all wood species. <ul style="list-style-type: none"> • Due to their size, these blocks are only available by wood species (ie: Alder, Birch, Cherry, etc.). • They are not available in specific grades (ie: Natural/Standard, Select/Premium, etc.), or cuts (ie: Quarter Sawn, Rift Cut, etc.).
2	MDF Stiles/Rails with Solid Wood Applied Molding	When stiles/rails are MDF, the corner block molding will be made from either Maple, Birch or Poplar.

Stile & Rail - Applied Molding - Corner Blocks - END

E

► For PRICING ► See Section E.7 in our current Wholesale Pricing Catalog.

Beaded, Egg & Dart and Plain Molding

E

#3149 **1/4" Embossed Beaded Molding**

** Due to tear out in the manufacturing process, this molding is only available in Maple.*

#2381 **7/16" Embossed Beaded Molding**

#1356 **3/16" Embossed Beaded Molding**

#1999 **13/32" Plain Accent Molding**

** This molding is similar to molding #1108 without the embossed Egg & Dart pattern.*

#1108 **3/8" Embossed Egg & Dart Molding**

#3162 **13/32" Embossed Egg & Dart Molding**

Ordering & Pricing Notes: Beaded, Egg & Dart and Plain Molding (Outsourced)

Ordering Guidelines

1	Order Forms	Applicable order forms will include spaces to indicate your chosen profiles.
Pricing		
1	Pricing	Please see <i>Section E.8</i> of our current Wholesale Pricing Catalog.

Technical Notes: Beaded, Egg & Dart and Plain Molding (Outsourced)

Finish Options (Chapter R)

1	Finishing	Finishing Options are available. Please see <i>Chapter R</i> .
----------	------------------	--

Molding Options (Chapter N)

1	Drawings	These solid wood moldings are drawn to actual size.
2	Outsourced Molding	These moldings are outsourced. See <i>Section N.13</i> for more information on size tolerances for outsourced molding.

Profile Options (Chapter E)

1	Application	These moldings may also be applied to some "Traditional" and "Mitered" Stile & Rail profiles with a shelf as well as some "Mitered" profiles with a RAM rout (<i>Section E.6</i>).
----------	--------------------	--

Beaded, Egg & Dart and Plain Molding (Outsourced) - END

C = Available for Convex/Concave products. **OS** = Product outsourced from other vendor.

► **For PRICING** ► See *Section E.8* in our current Wholesale Pricing Catalog.

Half Round Rope Molding (Face & End Views)

#1168

3/16" Diameter Half Round Rope Molding

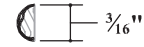

OS * These options are only available as Shelf or Recessed Applied Moldings.

#1169

1/4" Diameter Half Round Rope Molding



OS * These options are only available as Shelf or Recessed Applied Moldings.

#1008

3/8" Diameter Half Round Rope Molding



C OS

#3253

3/8" Diameter Half Round Rope Molding



OS

#809

1/2" Diameter Half Round Rope Molding



OS

#3255

1/2" Diameter Half Round Rope Molding



OS

#810

3/4" Diameter Half Round Rope Molding

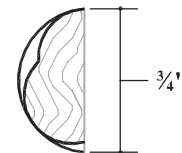
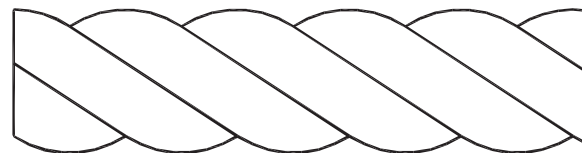

OS

Continued on next page...

C = Available for Convex/Concave products. **OS** = Product outsourced from other vendor.

► For PRICING ► See Section E.8 in our current Wholesale Pricing Catalog.

Half Round Rope Molding (Face & End Views)...continued

#811

1" Diameter Half Round Rope Molding

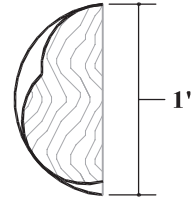
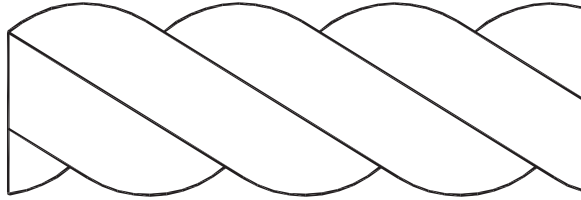

OS

#1009

1 1/2" Diameter Half Round Rope Molding

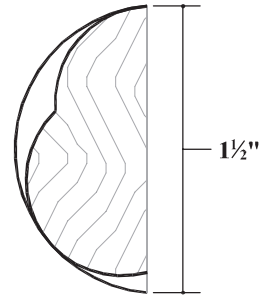
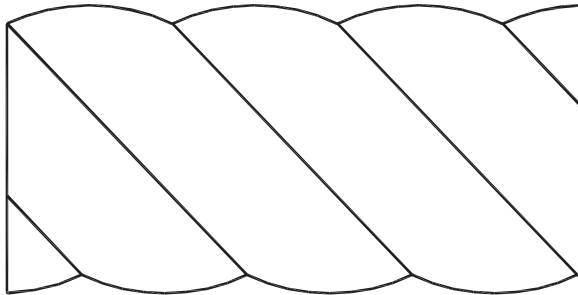

OS

Ordering & Pricing Notes: Half Round Rope Molding (Outsourced)

Ordering Guidelines

1	Order Forms	Applicable order forms will include spaces to indicate your chosen profiles.
Pricing		
1	Pricing	Please see <i>Section E.8</i> of our current Wholesale Pricing Catalog.

Technical Notes: Half Round Rope Molding (Outsourced)

Finish Options (Chapter R)

1	Finishing	Finishing options are available. Please see <i>Chapter R</i> .
----------	------------------	--

Molding Options (Chapter N)

1	Drawings	These solid wood moldings are shown at full scale.
2	Outsourced Molding	These moldings are outsourced. See <i>Section N.13</i> for more information on size tolerances for outsourced molding.

Profile Options (Chapter E)

1	Application	These moldings can be used as a shelf applied molding, face applied molding, with a RAM rout or with a built-in shelf. • See <i>Sections E.5, E.6, E.9</i> and <i>E.10</i> for compatible stile & rail profiles.
----------	--------------------	---

Half Round Rope Molding (Outsourced) - END

C = Available for Convex/Concave products. OS = Product outsourced from other vendor.

► **For PRICING** ► See *Section E.8* in our current Wholesale Pricing Catalog.

Mitered Stile & Rail Profiles with Matching Mullion Stock

- The **MP600/MP6000** series of profiles are designed to accommodate stile and rail width flexibility.
- Available on Mitered, French Mitered and Adventure Series door styles from **Sections B.5, B.6, B.7, and B.8**.
- Requires the choice of an outside edge profile from **Section E.15** or a Molder Edge (**ME**) profile from the end of this section.
 - Some outside edge profiles are not available on any mitered construction.
- See **Technical Notes** at the end of this section for more information on **MP600/MP6000** profiles.

The following symbols and abbreviations may appear on profile drawings in this section and indicate the following:

- **[SW]** Profile available on products made from solid wood only.
- **[FM]** Profile available with French Miter construction.
- **[C]** Profile available on convex or concave products.
- **[AS]** Profile available with Adventure Series construction.

MP600/MP6000 profiles shown are also available as a Frame or Mullion door with the **GRF** profile. Profile drawings are shown with matching mullion stock where available. See **Section B.12** and the **Technical Notes** at the end of this section for more information.

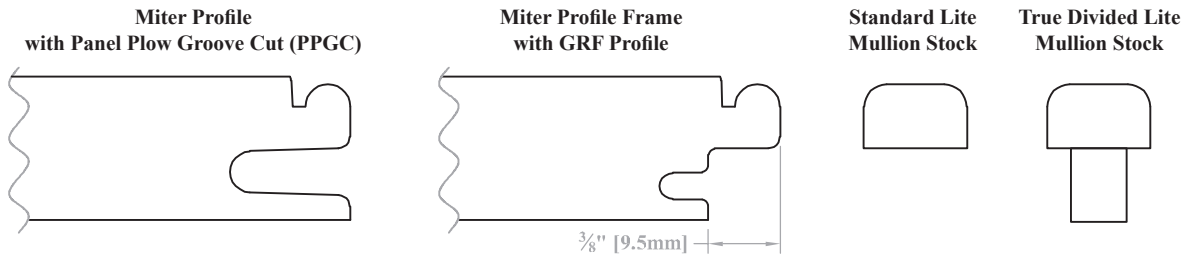

MP600 Family

Center Stiles & Rails will look like these profiles.

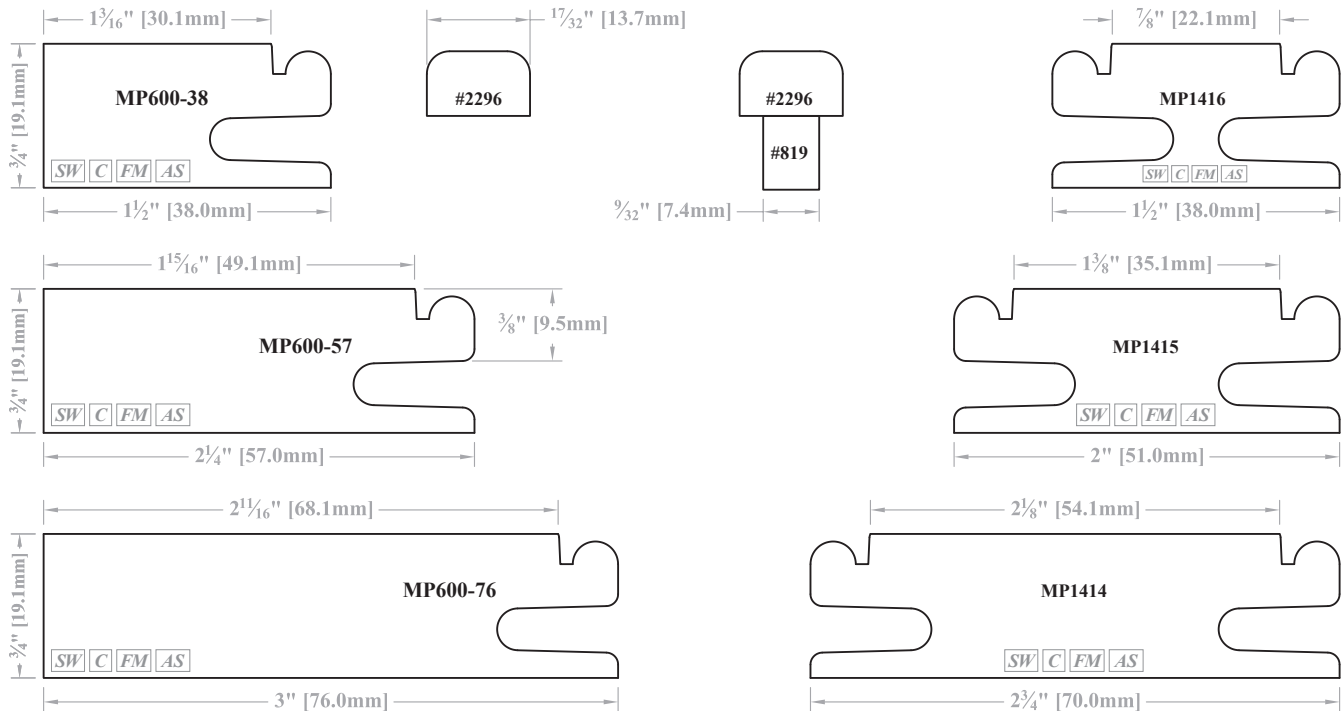

[SW] = Available in Solid Wood.

[FM] = Available for French Miter Doors.

[C] = Available for Convex/Concave products.

[AS] = Available on Adventure Series Doors.

► **For PRICING** ► See **Section E.9** in our current Wholesale Pricing Catalog.

Mitered Stile & Rail Profiles with Matching Mullion Stock

MP601 Family

Center Stiles & Rails will look like these profiles.

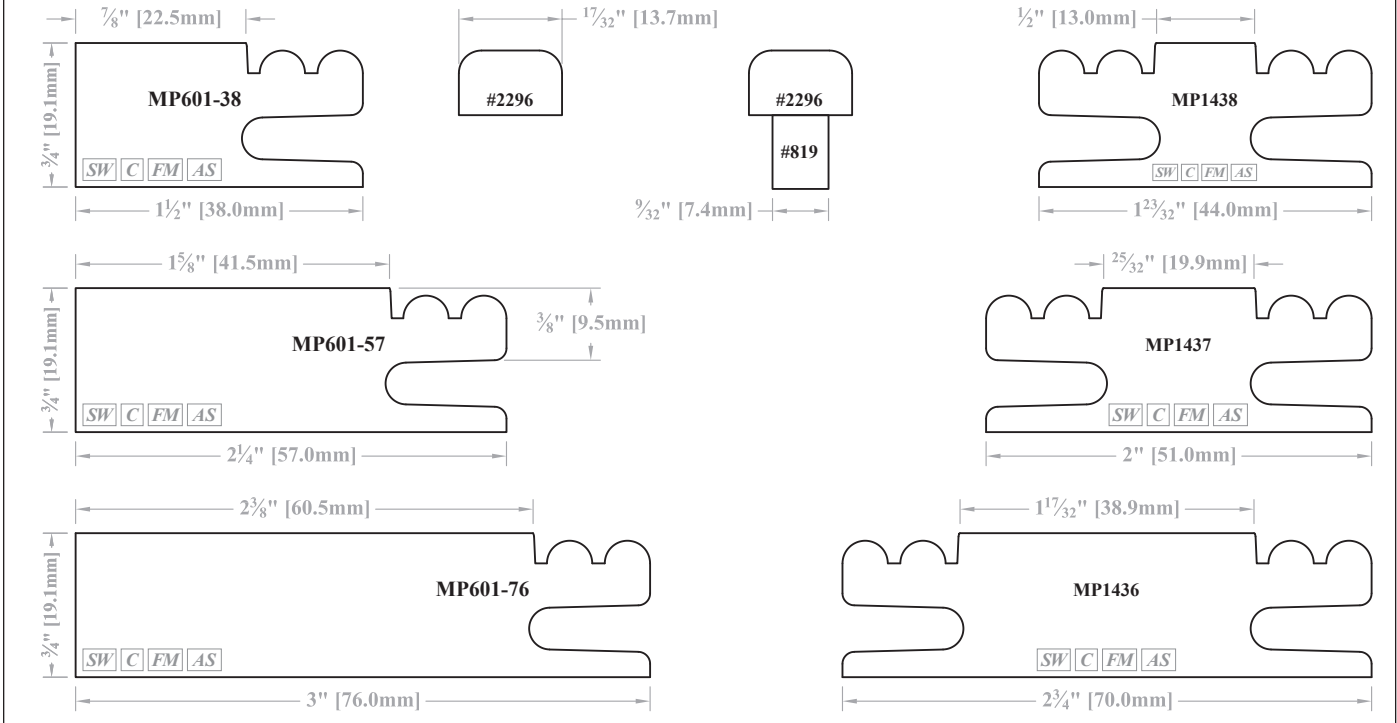

MP602 Family

Center Stiles & Rails will look like these profiles.

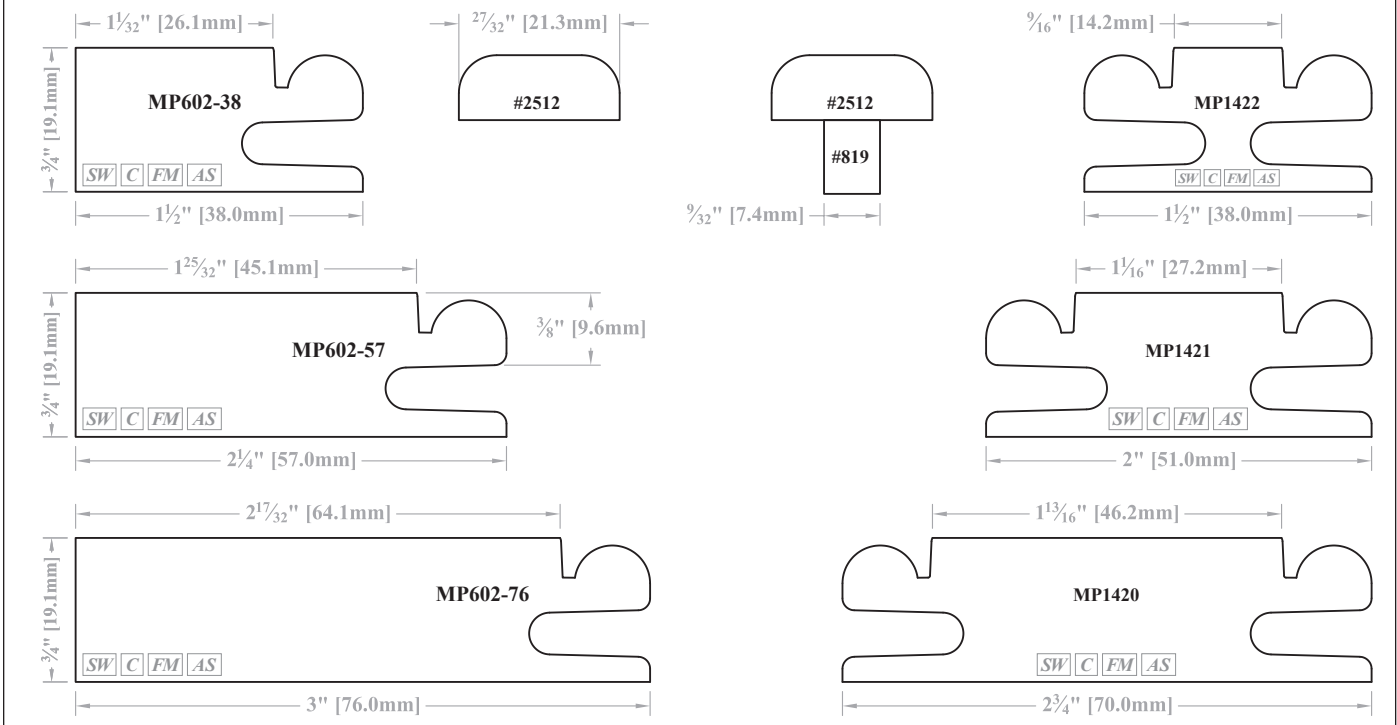

SW = Available in Solid Wood.

FM = Available for French Miter Doors.

C = Available for Convex/Concave products.

AS = Available on Adventure Series Doors.

► For PRICING ► See Section E.9 in our current Wholesale Pricing Catalog.

Profile Options

Stile & Rail - "Mitered" Mortise & Tenon Joinery - MP600/MP6000 Series

Mitered Stile & Rail Profiles with Matching Mullion Stock

MP603 Family

Center Stiles & Rails will look like these profiles.

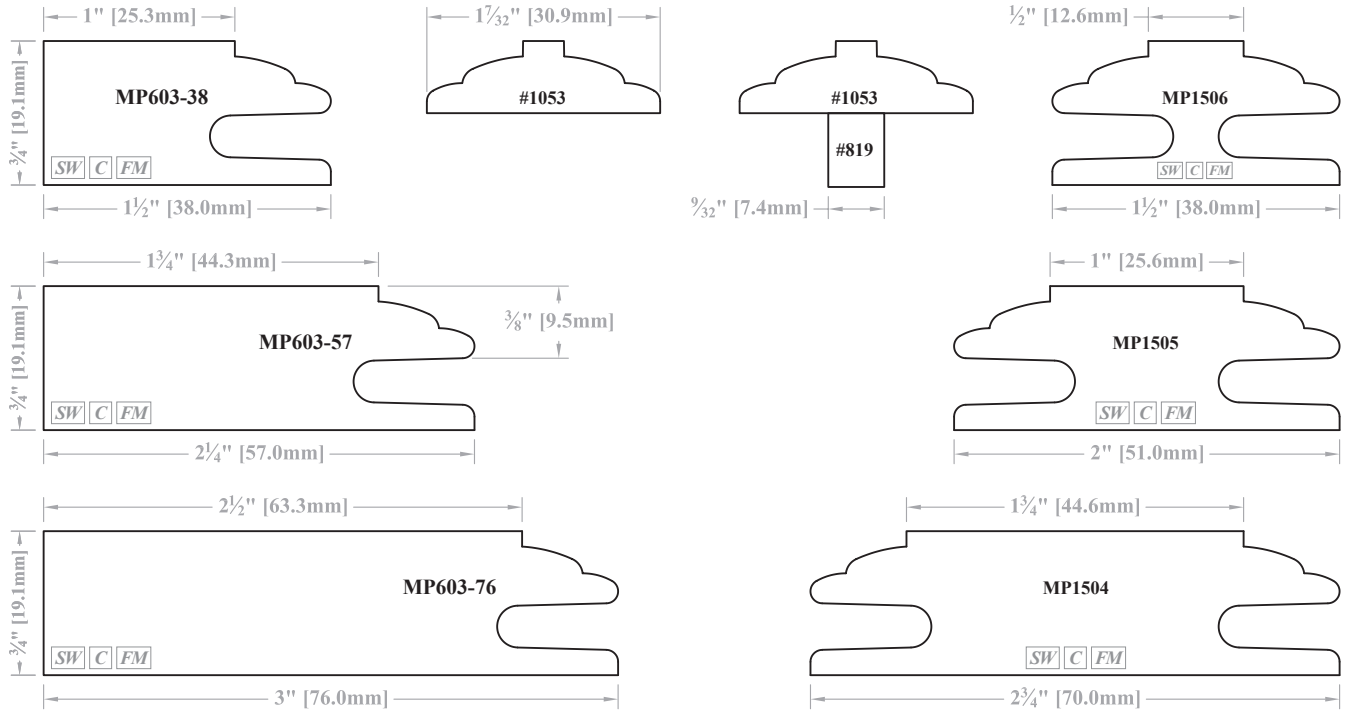

MP604 Family

Center Stiles & Rails will look like these profiles.

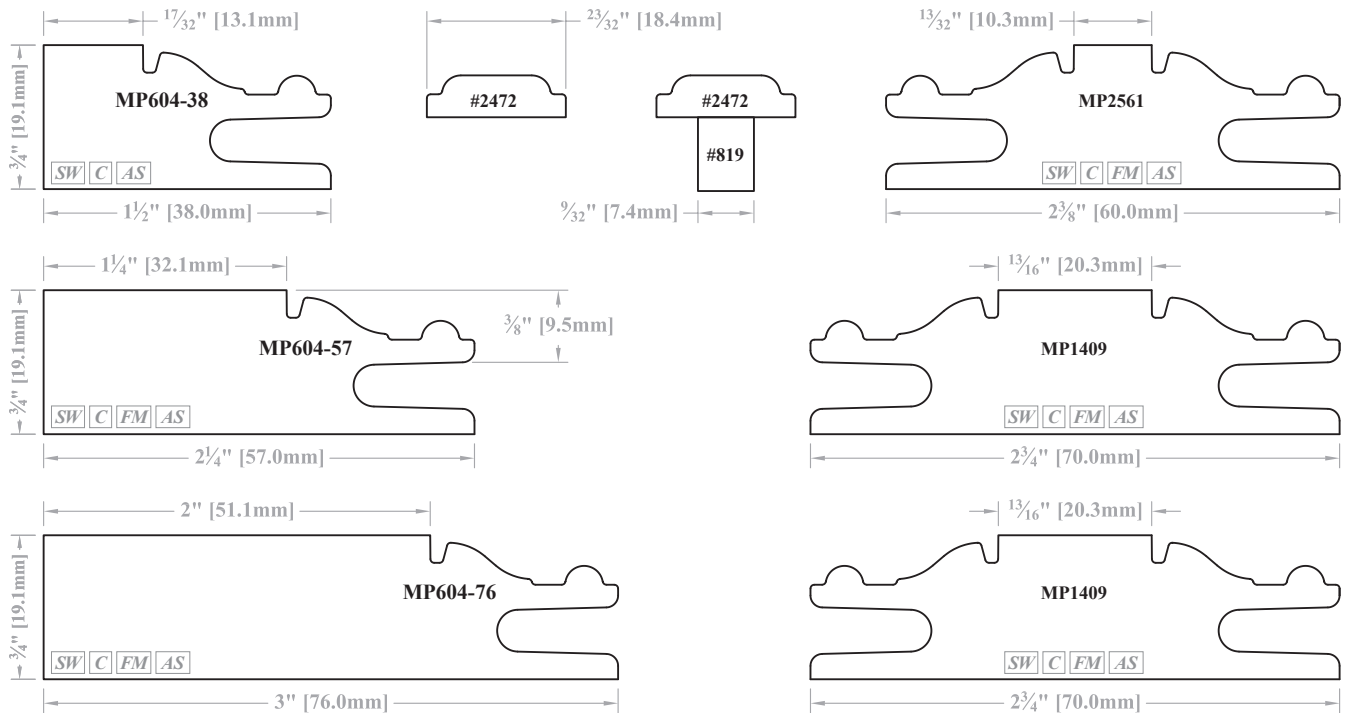

SW = Available in Solid Wood.

FM = Available for French Miter Doors.

C = Available for Convex/Concave products.

AS = Available on Adventure Series Doors.

► For PRICING ► See Section E.9 in our current Wholesale Pricing Catalog.

Mitered Stile & Rail Profiles with Matching Mullion Stock

MP605 Family

Center Stiles & Rails will look like these profiles.

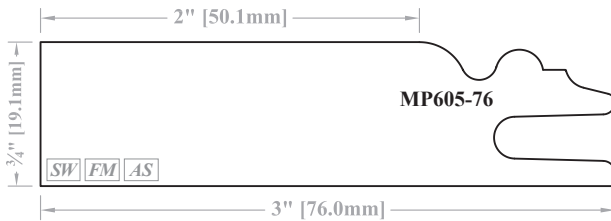
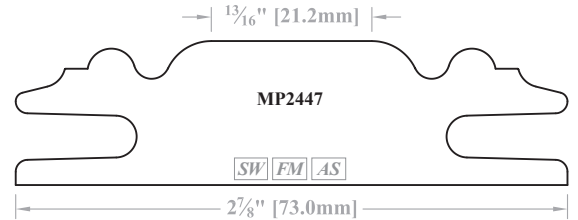
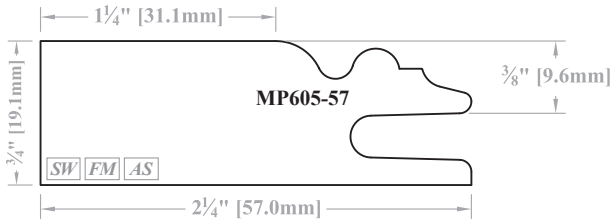
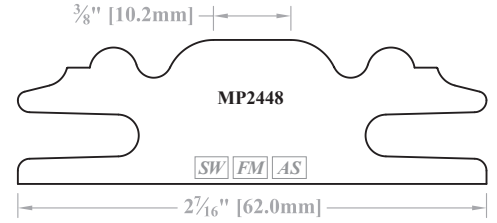
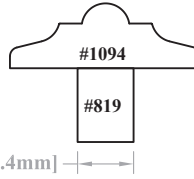
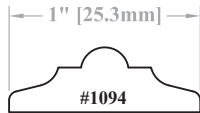
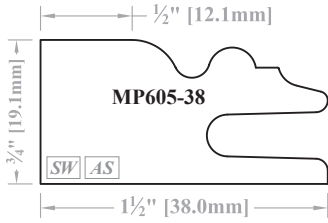

MP605-76 uses MP2446 for center stiles & rails as shown below.

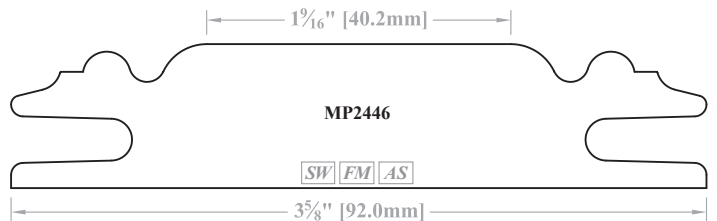

E

SW = Available in Solid Wood.

FM = Available for French Miter Doors.

C = Available for Convex/Concave products.

AS = Available on Adventure Series Doors.

► For PRICING ► See Section E.9 in our current Wholesale Pricing Catalog.

Profile Options

Stile & Rail - "Mitered" Mortise & Tenon Joinery - MP600/MP6000 Series

Mitered Stile & Rail Profiles with Matching Mullion Stock

MP606 Family

Center Stiles & Rails will look like these profiles.

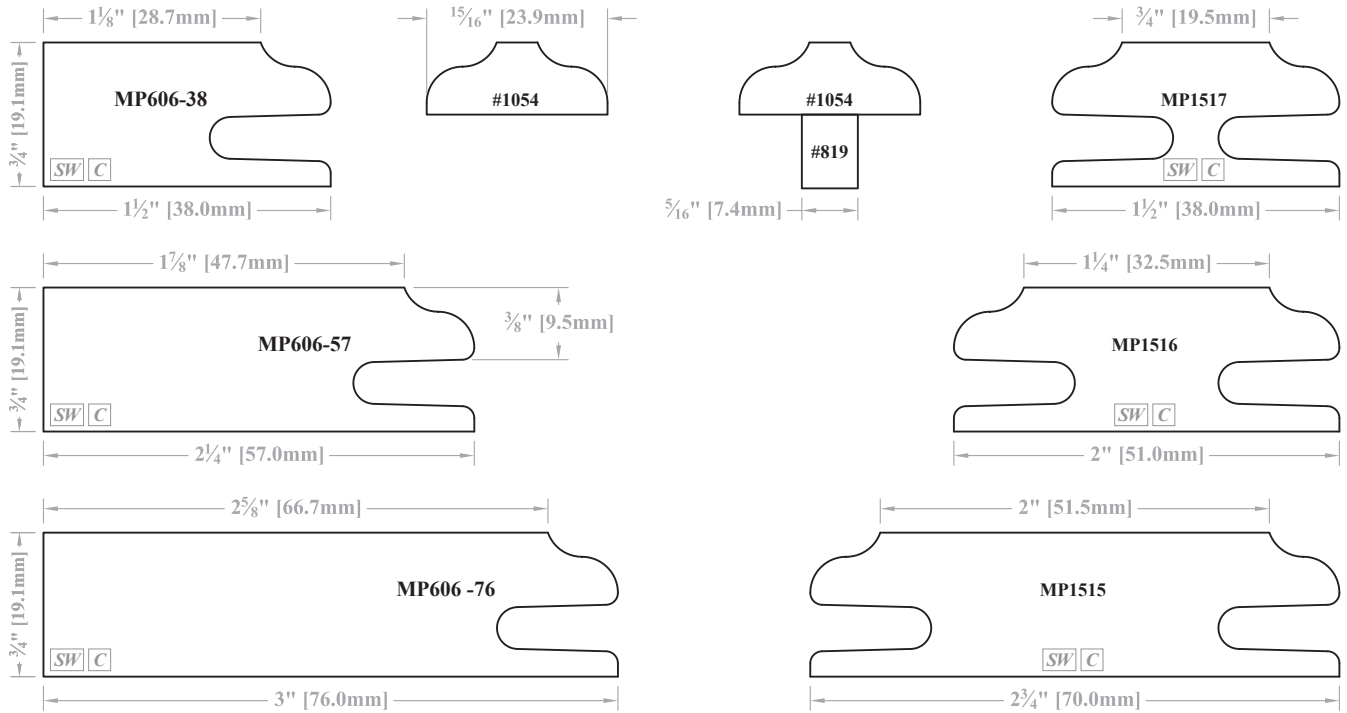

MP607 Family

Center Stiles & Rails will look like these profiles.

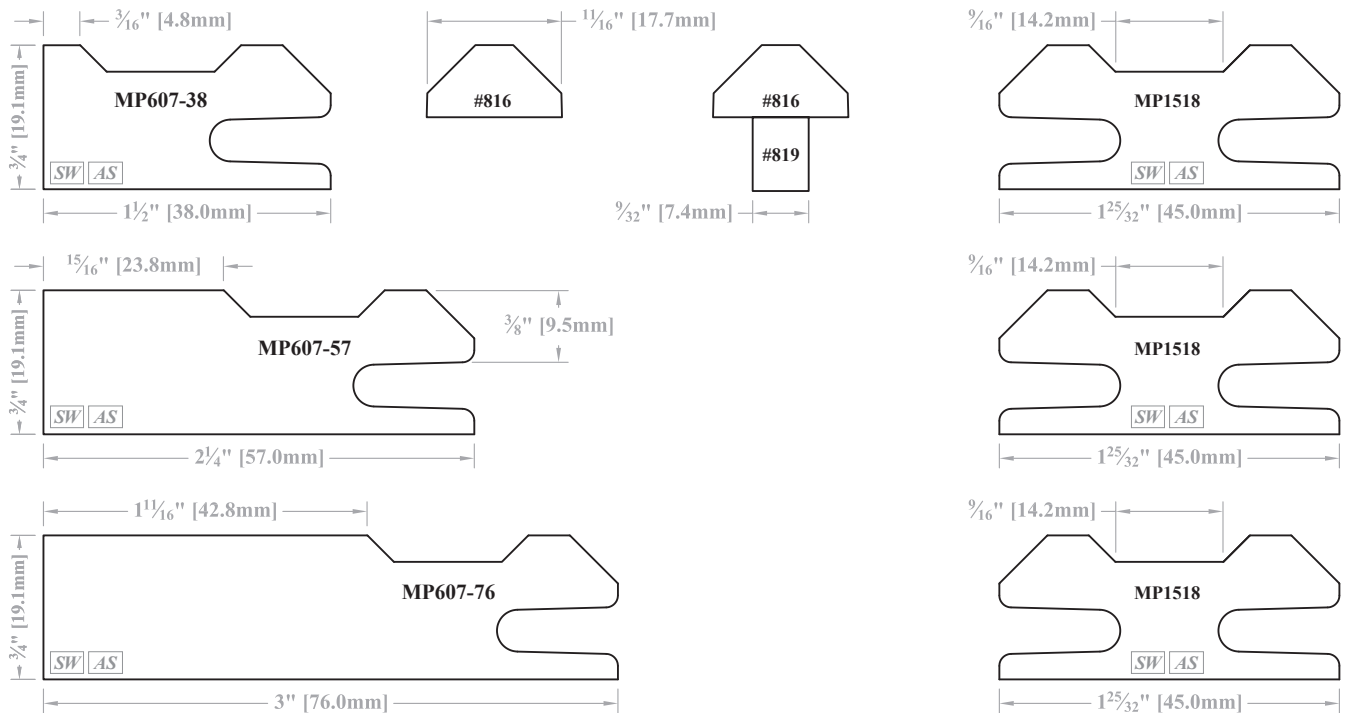

SW = Available in Solid Wood.

FM = Available for French Miter Doors.

C = Available for Convex/Concave products.

AS = Available on Adventure Series Doors.

► For PRICING ► See Section E.9 in our current Wholesale Pricing Catalog.

Mitered Stile & Rail Profiles with Matching Mullion Stock

MP608 Family

Center Stiles & Rails will look like these profiles.

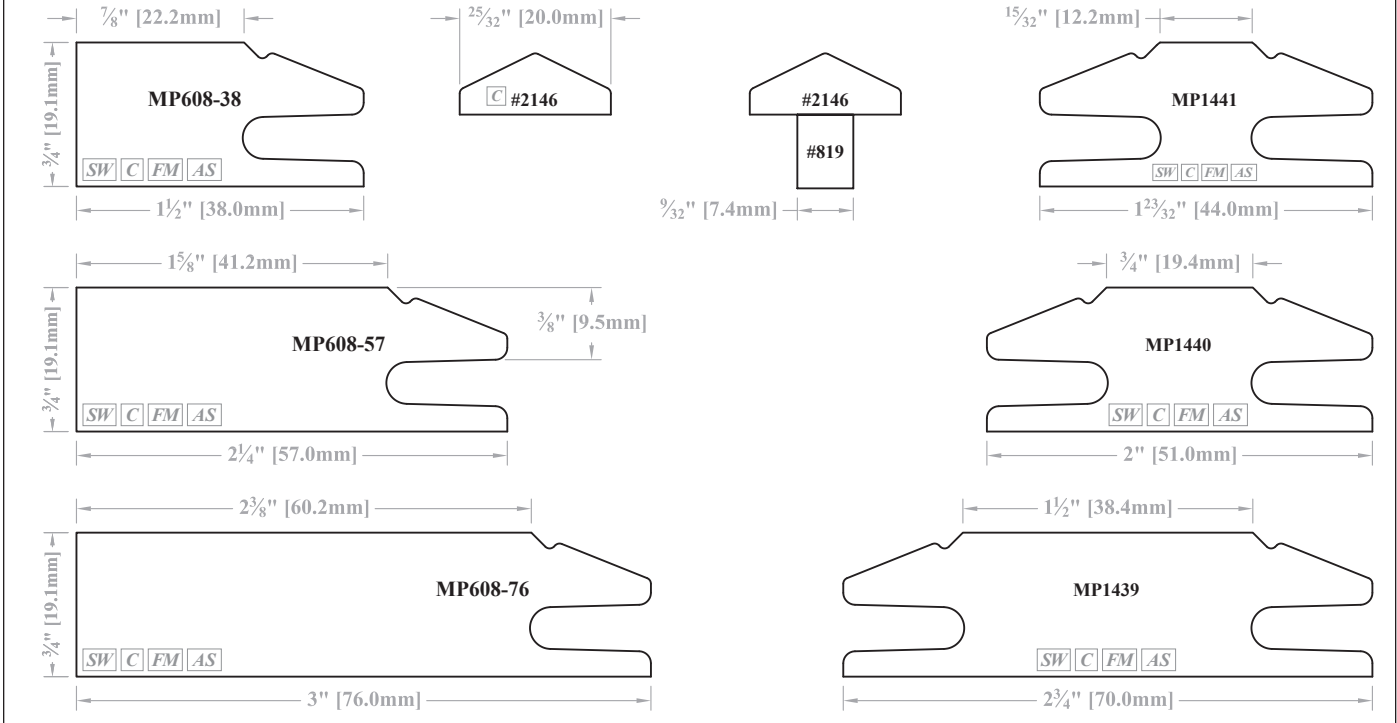

MP609 Family

Center Stiles & Rails will look like these profiles.

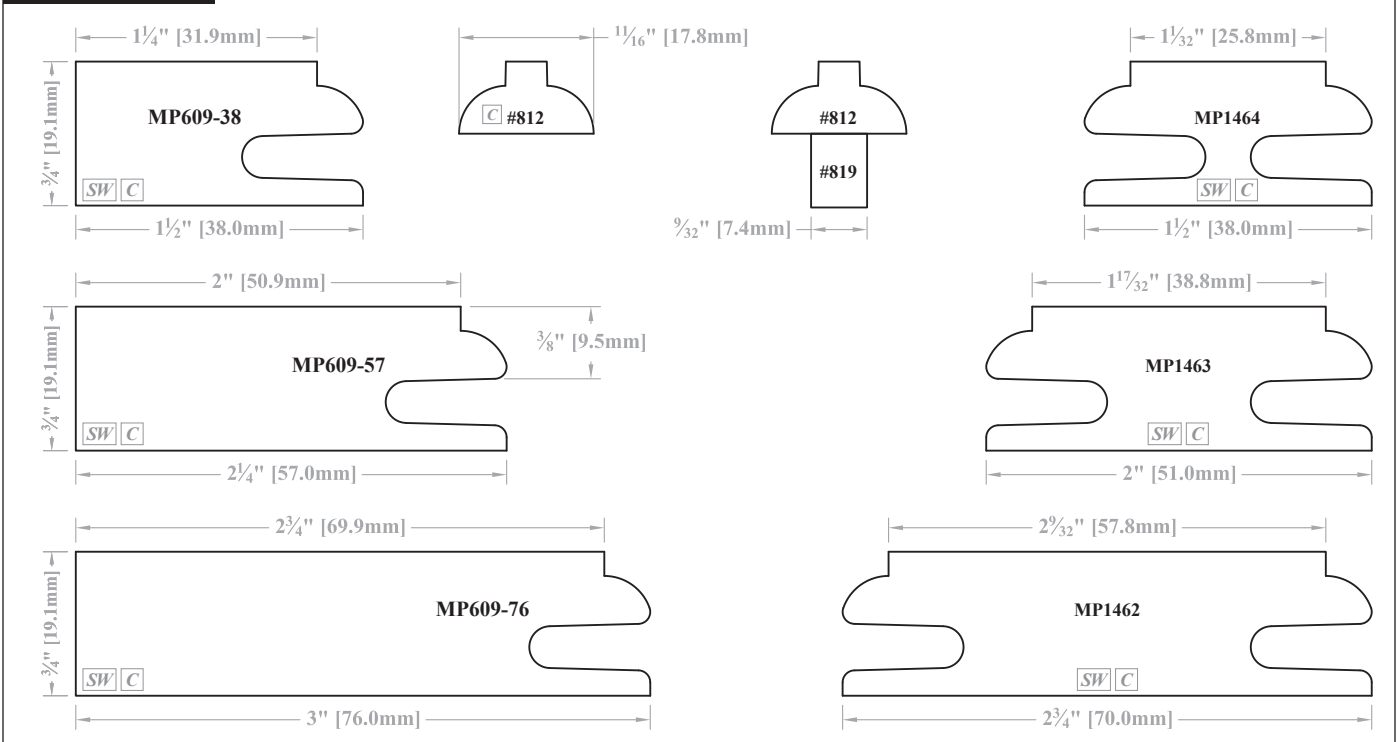

SW = Available in Solid Wood.

FM = Available for French Miter Doors.

C = Available for Convex/Concave products.

AS = Available on Adventure Series Doors.

► For PRICING ► See Section E.9 in our current Wholesale Pricing Catalog.

Profile Options

Stile & Rail - "Mitered" Mortise & Tenon Joinery - MP600/MP6000 Series

Mitered Stile & Rail Profiles with Matching Mullion Stock

MP610 Family

Center Stiles & Rails will look like these profiles.

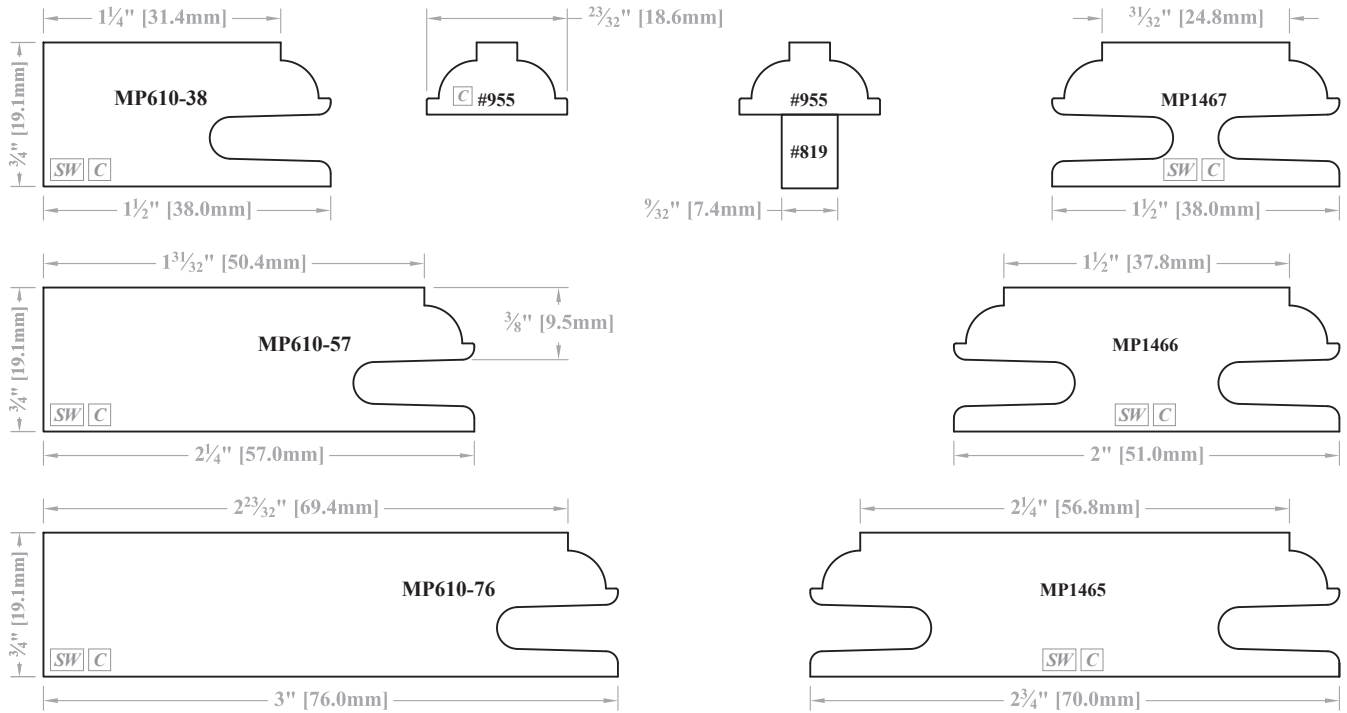

MP611 Family

Center Stiles & Rails will look like these profiles.

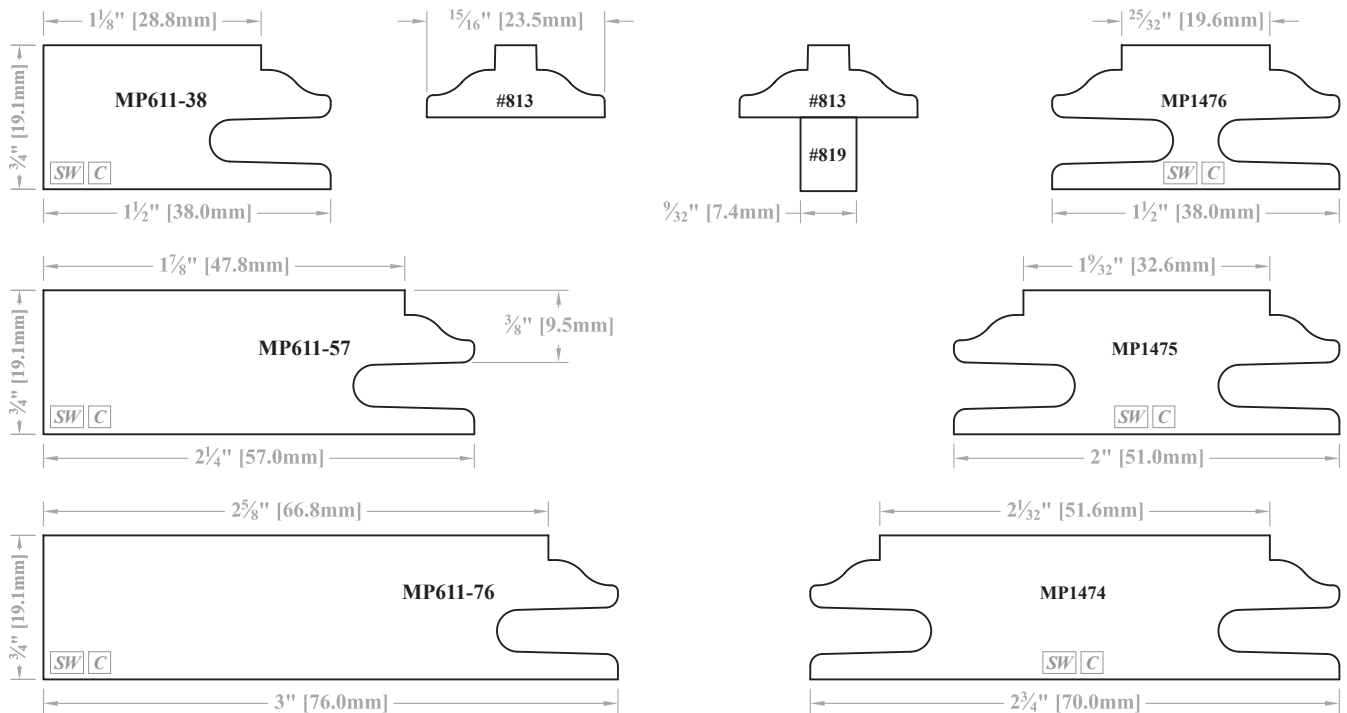

[SW] = Available in Solid Wood.

[FM] = Available for French Miter Doors.

[C] = Available for Convex/Concave products.

[AS] = Available on Adventure Series Doors.

► For PRICING ► See Section E.9 in our current Wholesale Pricing Catalog.



Mitered Stile & Rail Profiles with Matching Mullion Stock

MP612 Family

Center Stiles & Rails will look like these profiles.

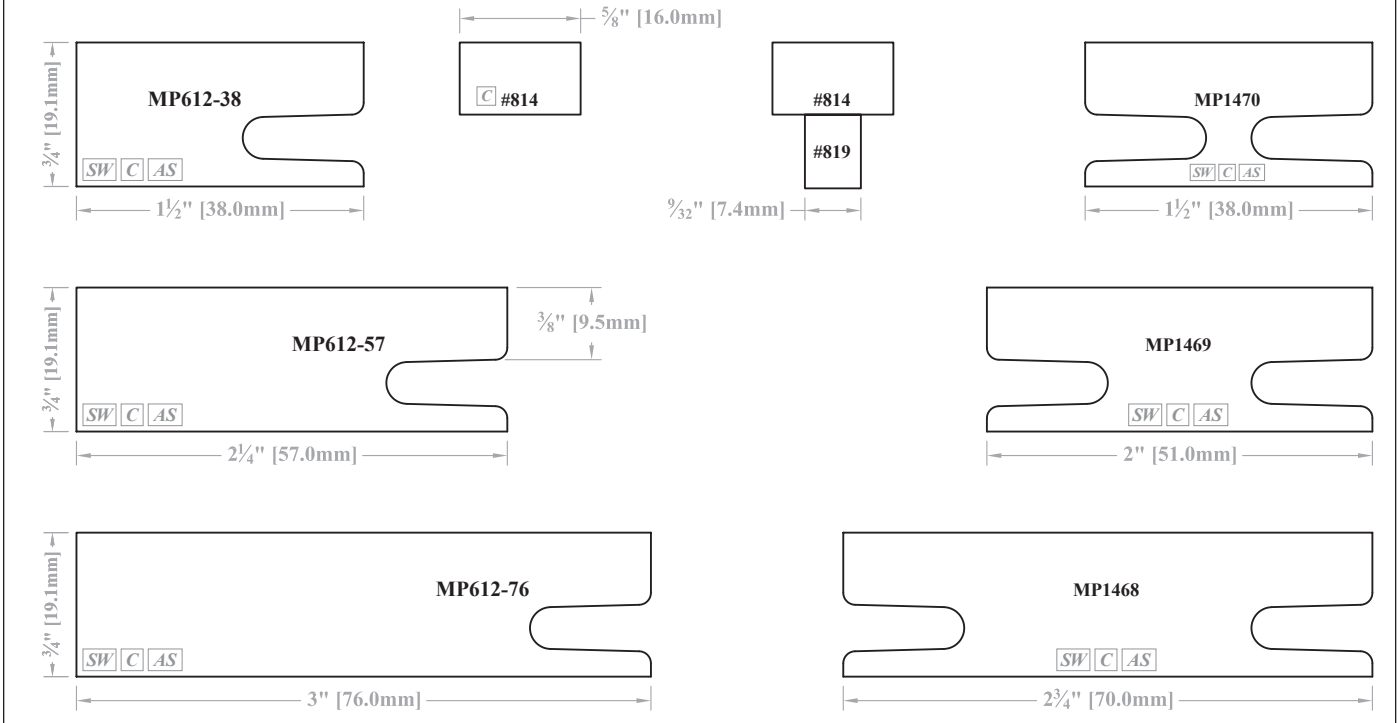

MP613 Family

See Profile Options notes in Section B.12 for alternative mullion.

Center Stiles & Rails will look like these profiles.

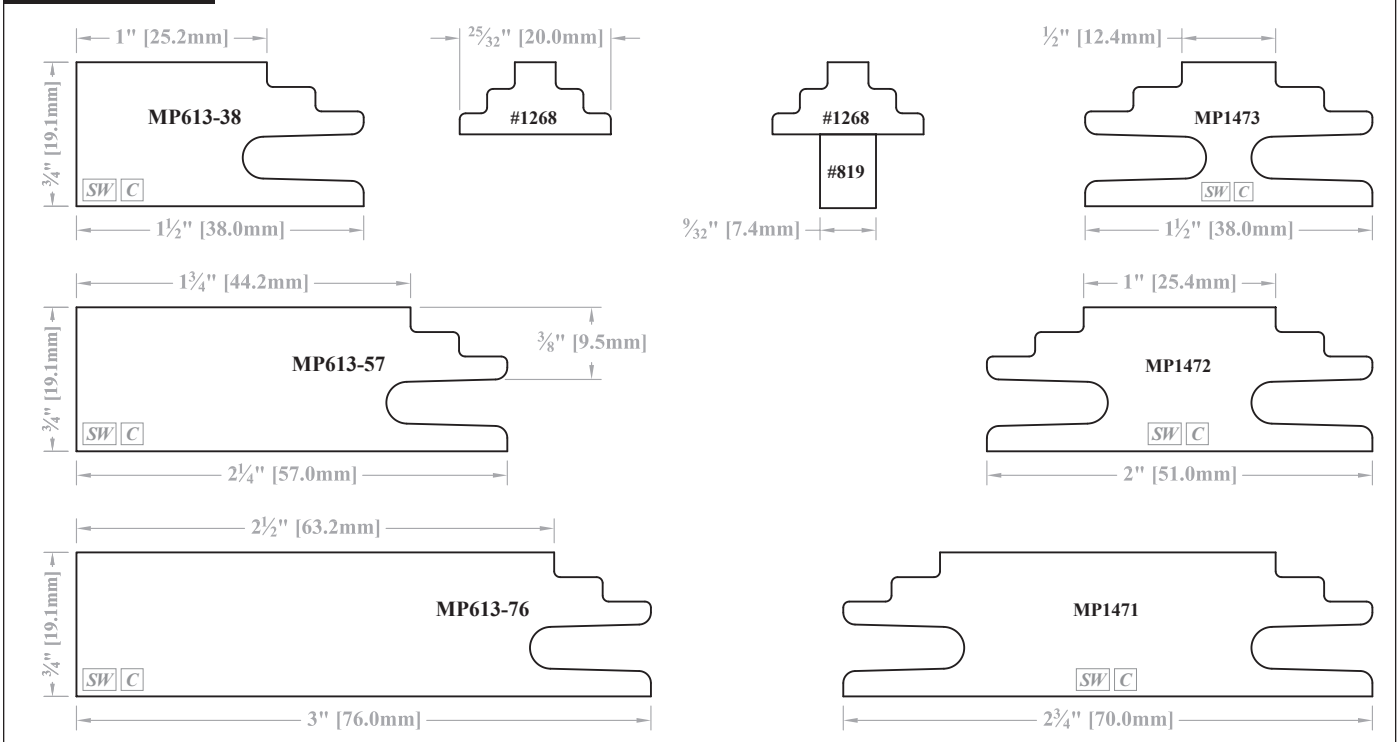

SW = Available in Solid Wood.

FM = Available for French Miter Doors.

C = Available for Convex/Concave products.

AS = Available on Adventure Series Doors.

► For PRICING ► See Section E.9 in our current Wholesale Pricing Catalog.

Profile Options

Stile & Rail - "Mitered" Mortise & Tenon Joinery - MP600/MP6000 Series

Mitered Stile & Rail Profiles with Matching Mullion Stock

MP614 Family

Center Stiles & Rails will look like these profiles.

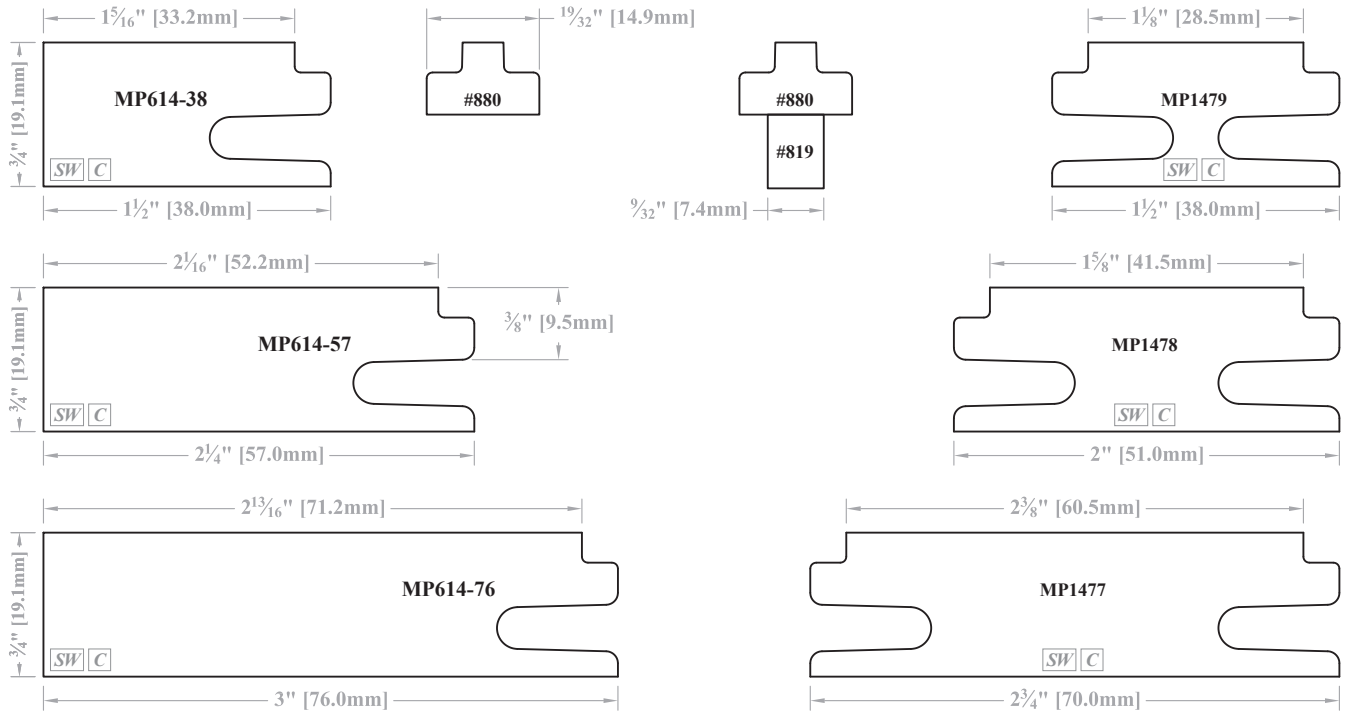

MP615 Family

(X) = Applied Molding Shelf, molding is optional

Center Stiles & Rails will look like these profiles.

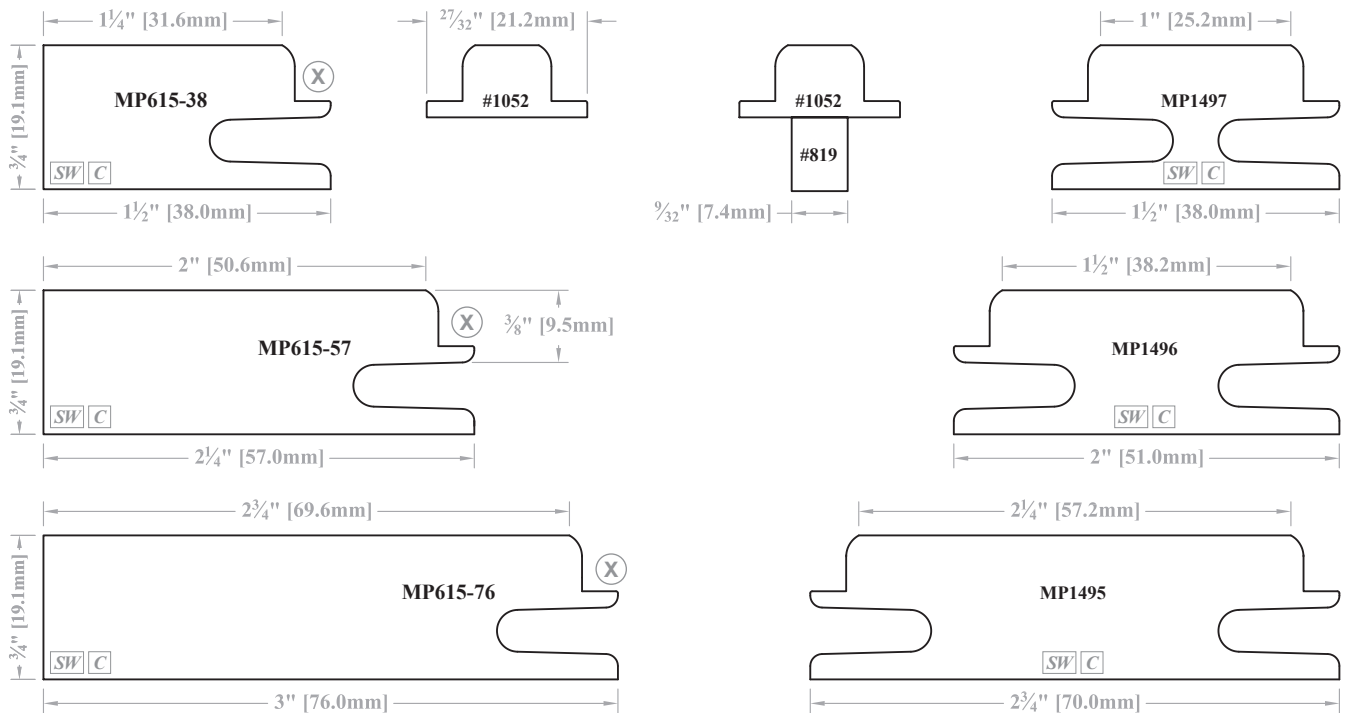

[SW] = Available in Solid Wood.

[FM] = Available for French Miter Doors.

[C] = Available for Convex/Concave products.

[AS] = Available on Adventure Series Doors.

► For PRICING ► See Section E.9 in our current Wholesale Pricing Catalog.

Mitered Stile & Rail Profiles with Matching Mullion Stock

MP616 Family

Center Stiles & Rails will look like these profiles.

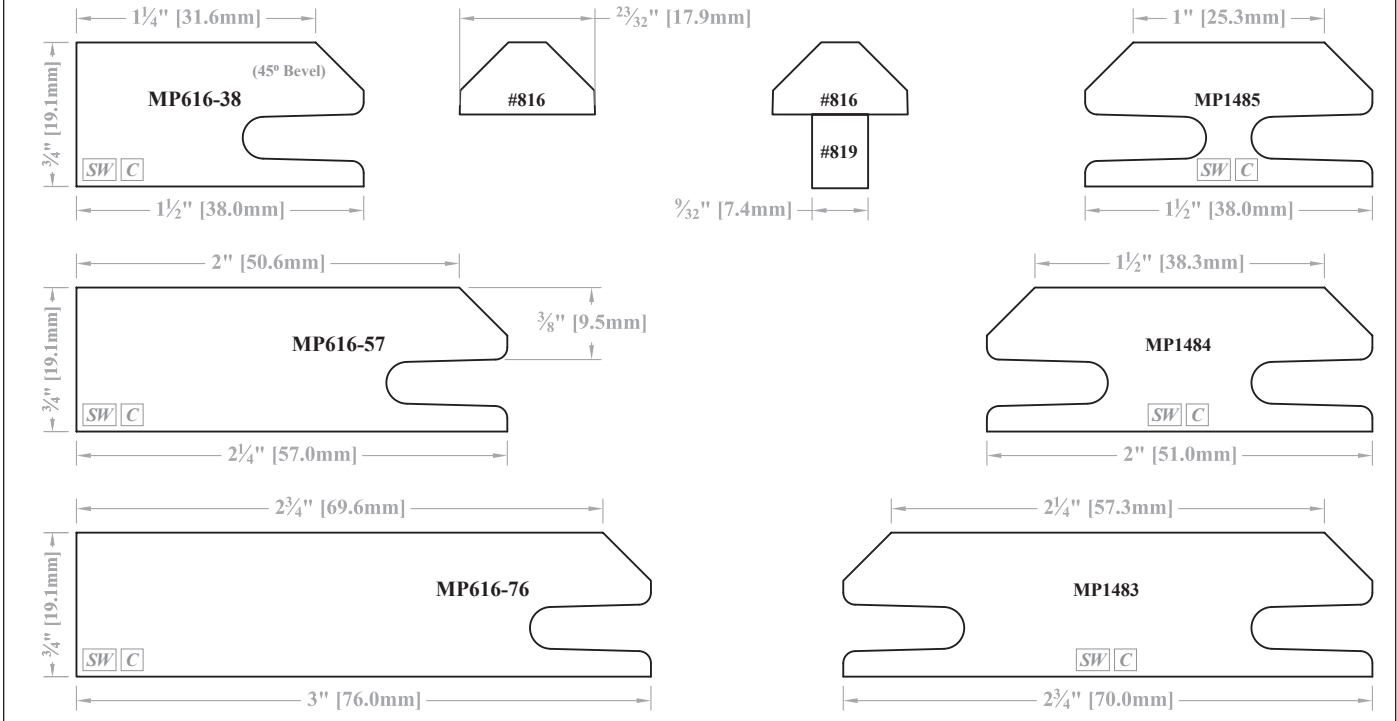

MP617 Family

Center Stiles & Rails will look like these profiles.

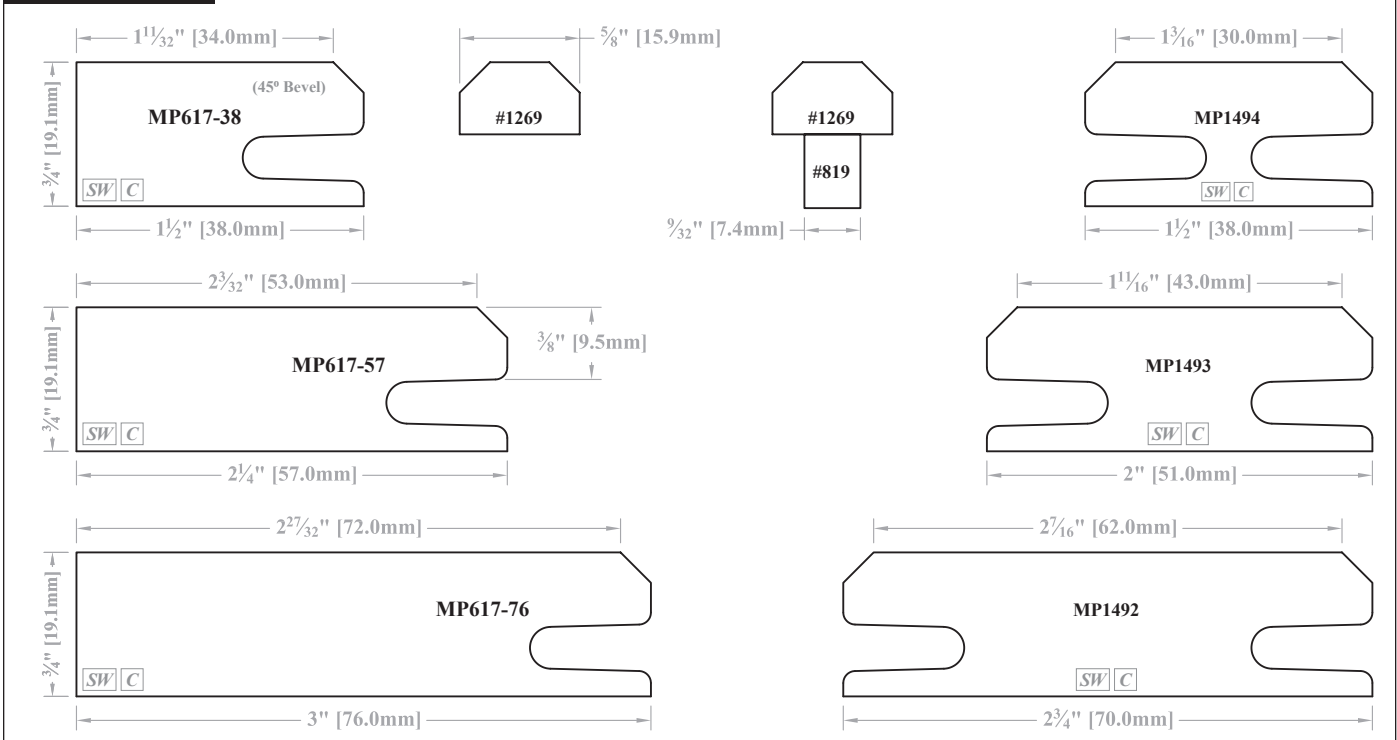

[SW] = Available in Solid Wood.

[FM] = Available for French Miter Doors.

[C] = Available for Convex/Concave products.

[AS] = Available on Adventure Series Doors.

► For PRICING ► See Section E.9 in our current Wholesale Pricing Catalog.

Profile Options

Stile & Rail - "Mitered" Mortise & Tenon Joinery - MP600/MP6000 Series

Mitered Stile & Rail Profiles with Matching Mullion Stock

MP618 Family

Center Stiles & Rails will look like these profiles.

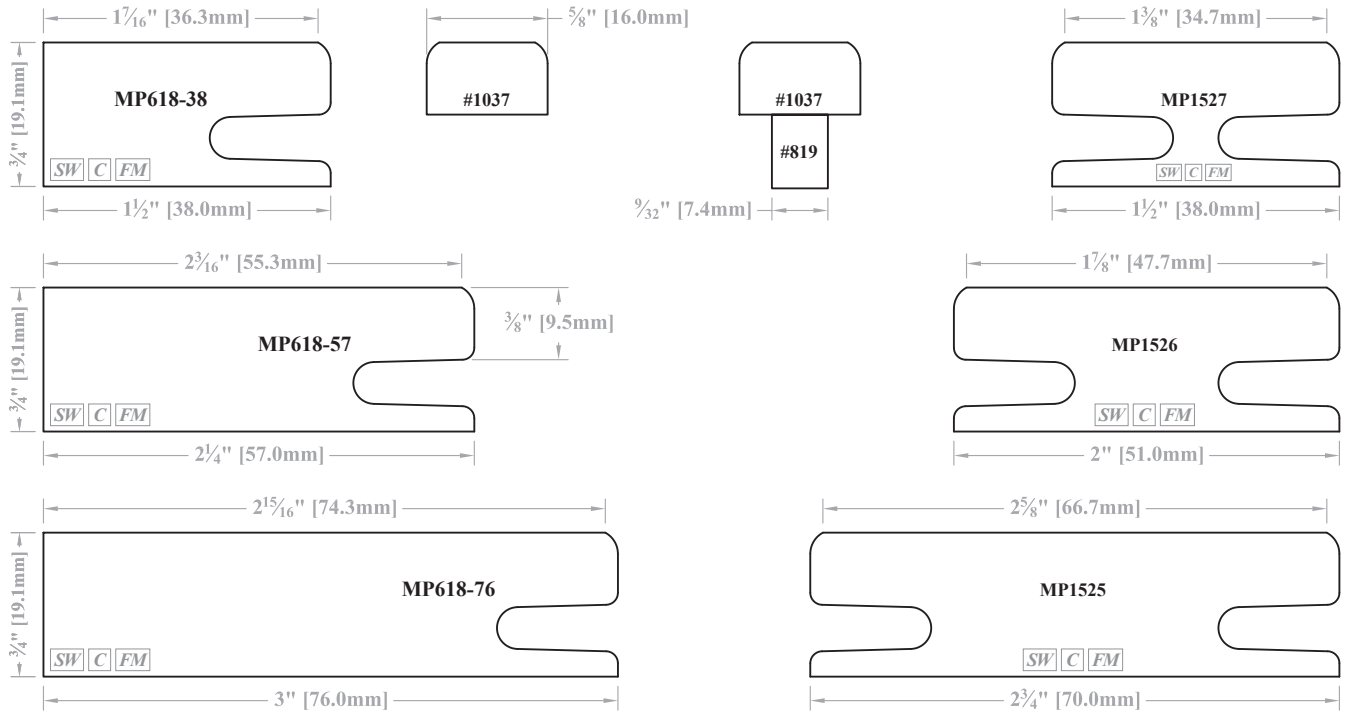

MP619 Family

Center Stiles & Rails will look like these profiles.

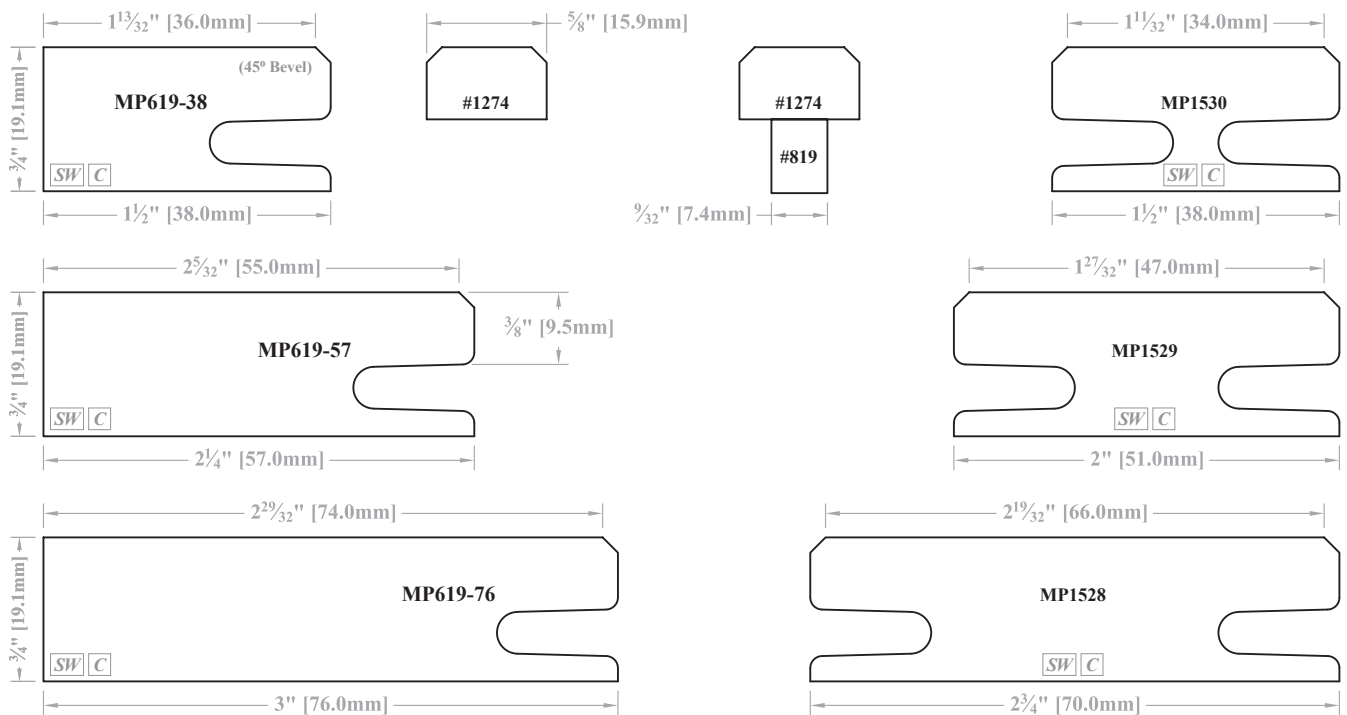

SW = Available in Solid Wood.

FM = Available for French Miter Doors.

C = Available for Convex/Concave products.

AS = Available on Adventure Series Doors.

► For PRICING ► See Section E.9 in our current Wholesale Pricing Catalog.

Mitered Stile & Rail Profiles with Matching Mullion Stock

MP620 Family

Center Stiles & Rails will look like these profiles.

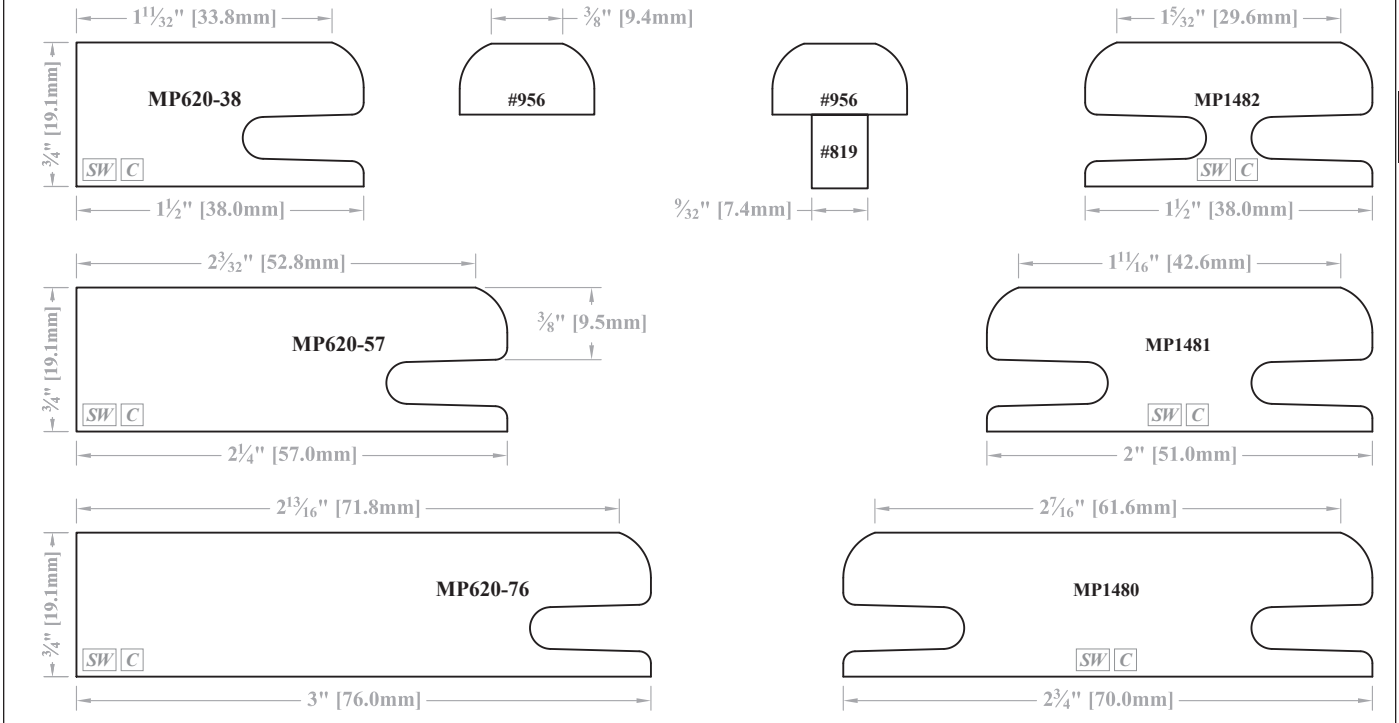

MP621 Family

Center Stiles & Rails will look like these profiles.

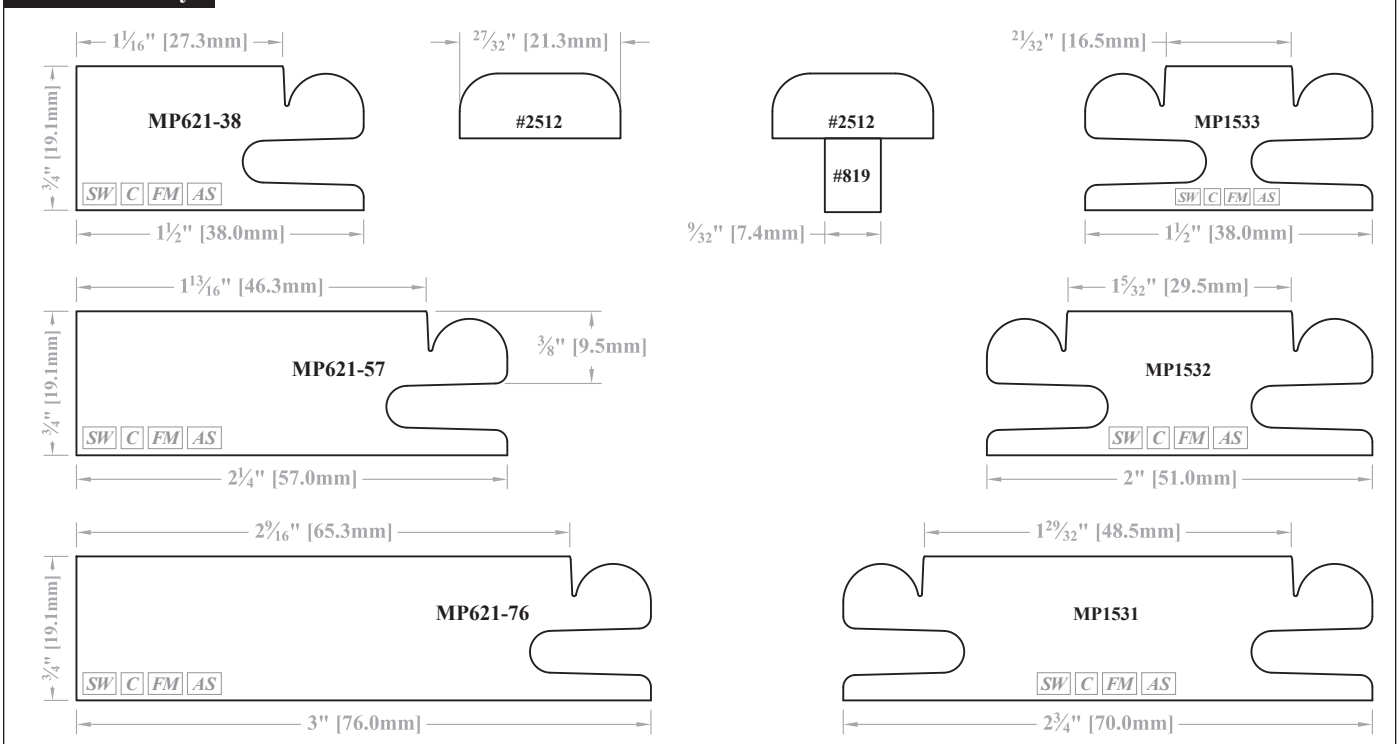

SW = Available in Solid Wood.

FM = Available for French Miter Doors.

C = Available for Convex/Concave products.

AS = Available on Adventure Series Doors.

► For PRICING ► See Section E.9 in our current Wholesale Pricing Catalog.

Profile Options

Stile & Rail - "Mitered" Mortise & Tenon Joinery - MP600/MP6000 Series

Mitered Stile & Rail Profiles with Matching Mullion Stock

MP622 Family

Center Stiles & Rails will look like these profiles.

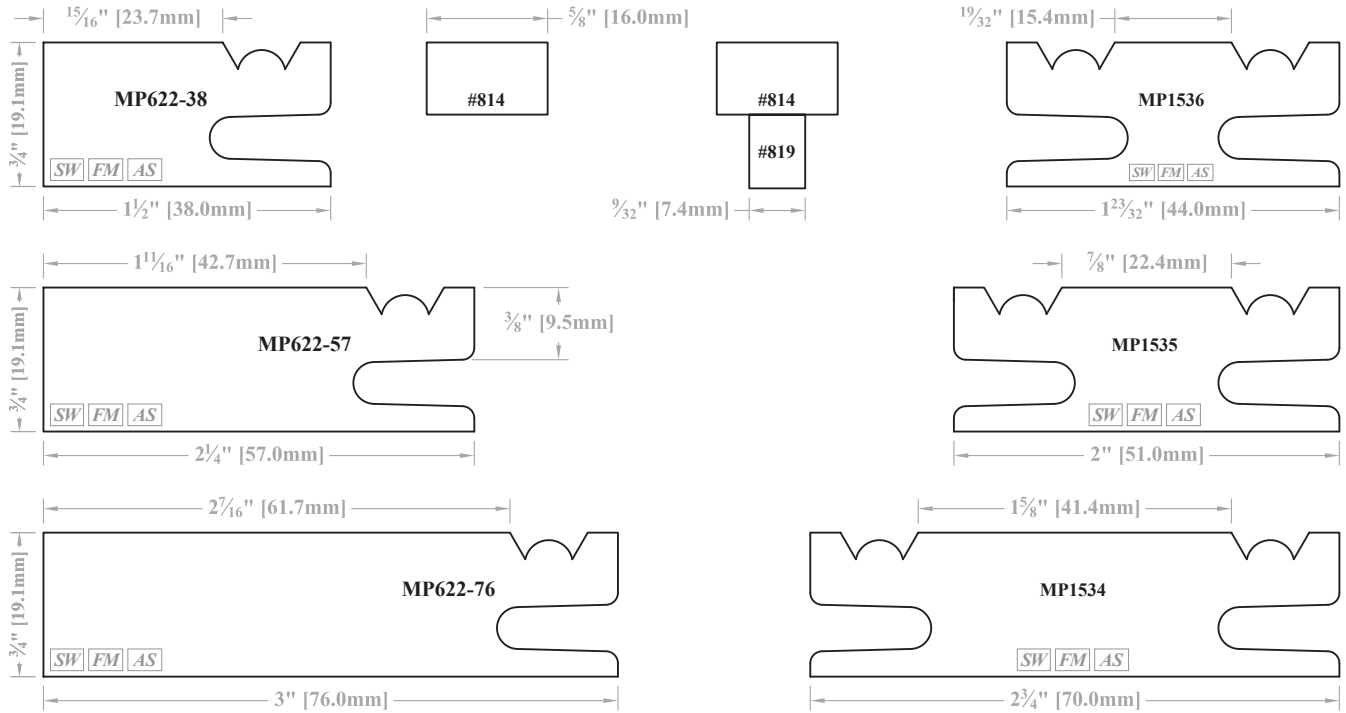

MP623 Family

Center Stiles & Rails will look like these profiles.

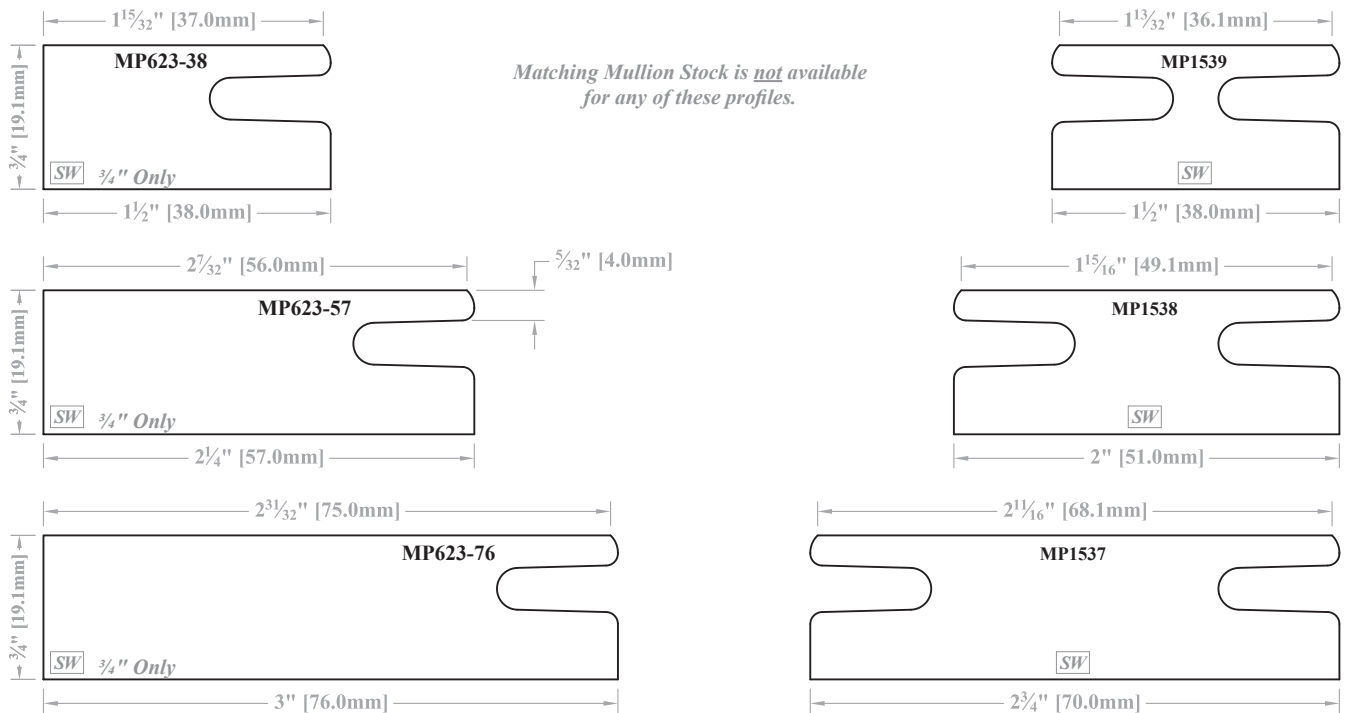

SW = Available in Solid Wood.

FM = Available for French Miter Doors.

C = Available for Convex/Concave products.

AS = Available on Adventure Series Doors.

► For PRICING ► See Section E.9 in our current Wholesale Pricing Catalog.

Mitered Stile & Rail Profiles with Matching Mullion Stock

MP624 Family

Center Stiles & Rails will look like these profiles.

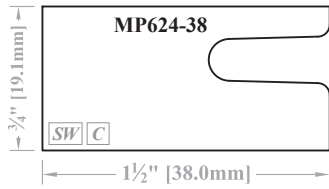

Matching Mullion Stock is not available for any of these profiles.

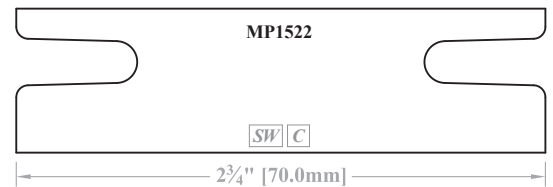
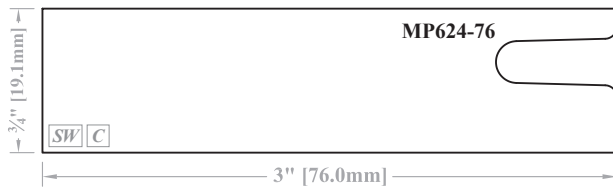
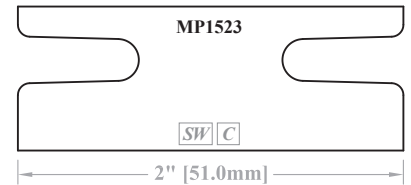
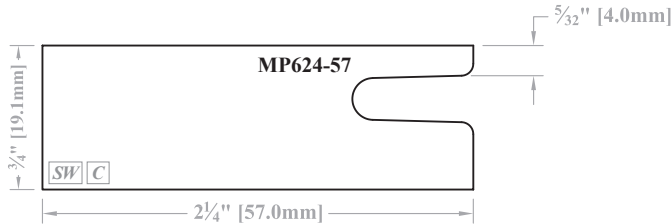
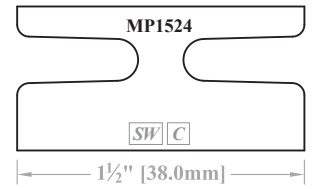

MP625 Family

(X) = Applied Molding Shelf, molding is optional

Center Stiles & Rails will look like these profiles.

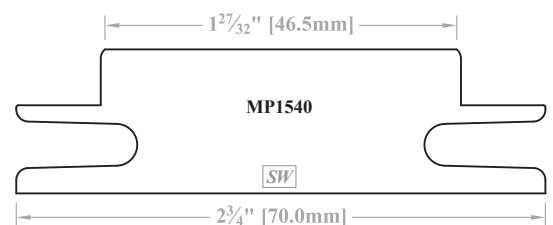
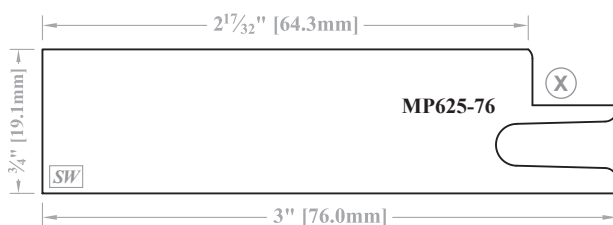
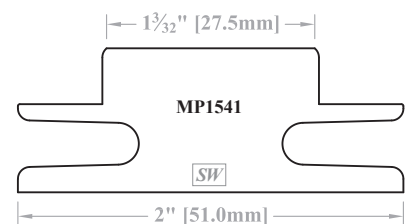
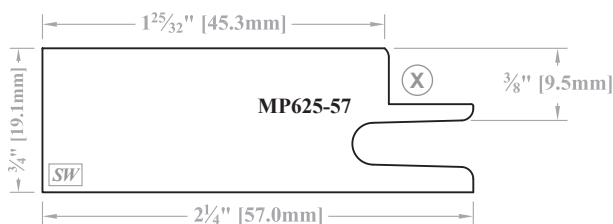
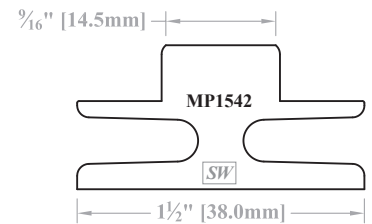
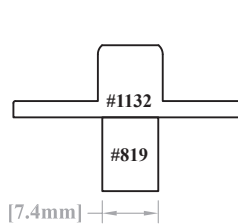
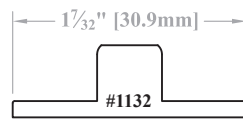
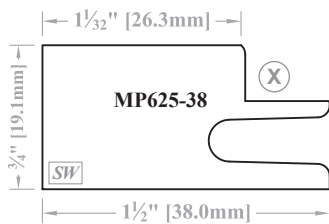

SW = Available in Solid Wood.

FM = Available for French Miter Doors.

C = Available for Convex/Concave products.

AS = Available on Adventure Series Doors.

► For PRICING ► See Section E.9 in our current Wholesale Pricing Catalog.

Profile Options

Stile & Rail - "Mitered" Mortise & Tenon Joinery - MP600/MP6000 Series

Mitered Stile & Rail Profiles with Matching Mullion Stock

MP626 Family

See *Profile Options* notes in *Section B.12* for alternative mullion.

Center Stiles & Rails will look like these profiles.

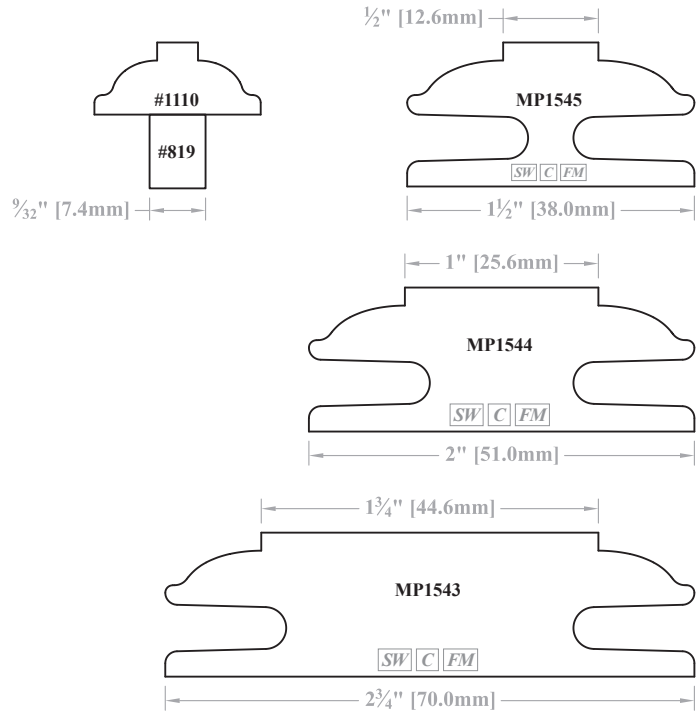
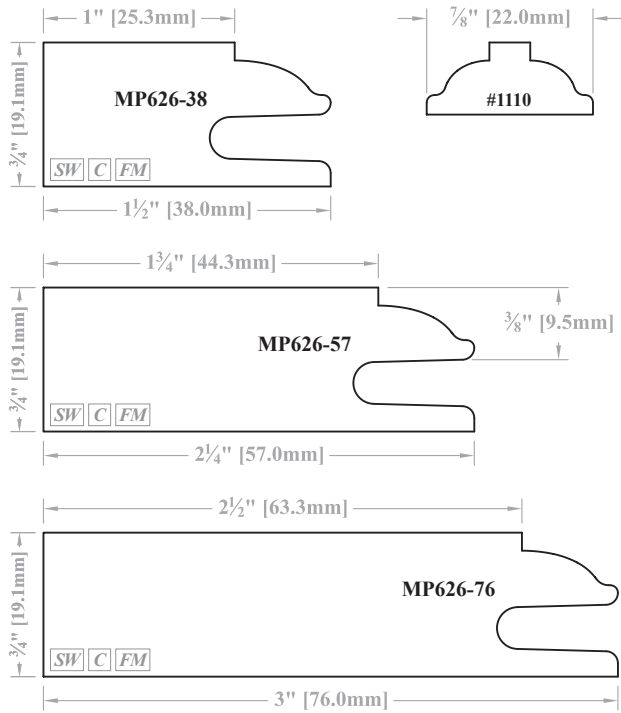

MP627 Family

Center Stiles & Rails will look like these profiles.

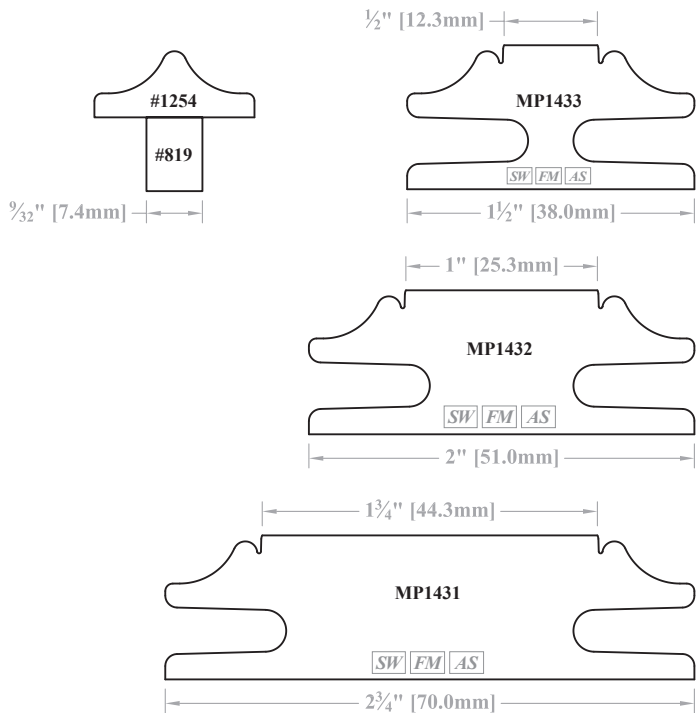
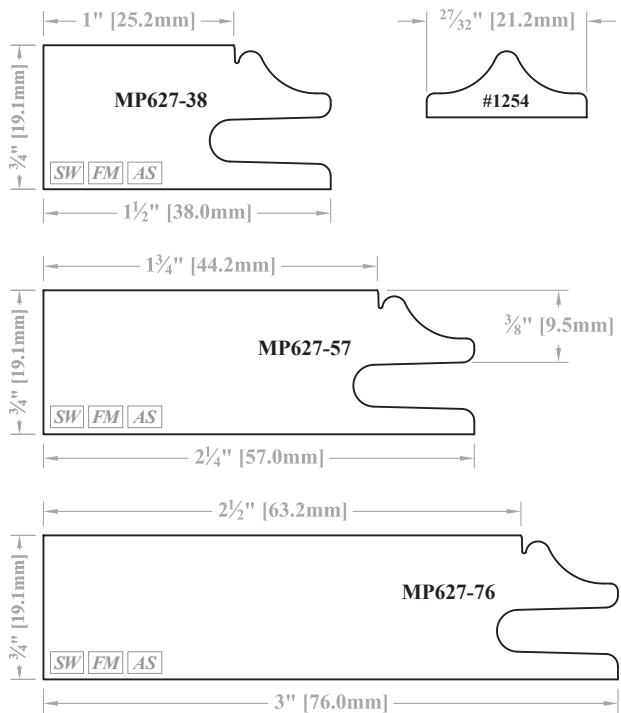

SW = Available in Solid Wood.

FM = Available for French Miter Doors.

C = Available for Convex/Concave products.

AS = Available on Adventure Series Doors.

► For PRICING ► See Section [E.9](#) in our current Wholesale Pricing Catalog.

Mitered Stile & Rail Profiles with Matching Mullion Stock

MP628 Family

Center Stiles & Rails will look like these profiles.

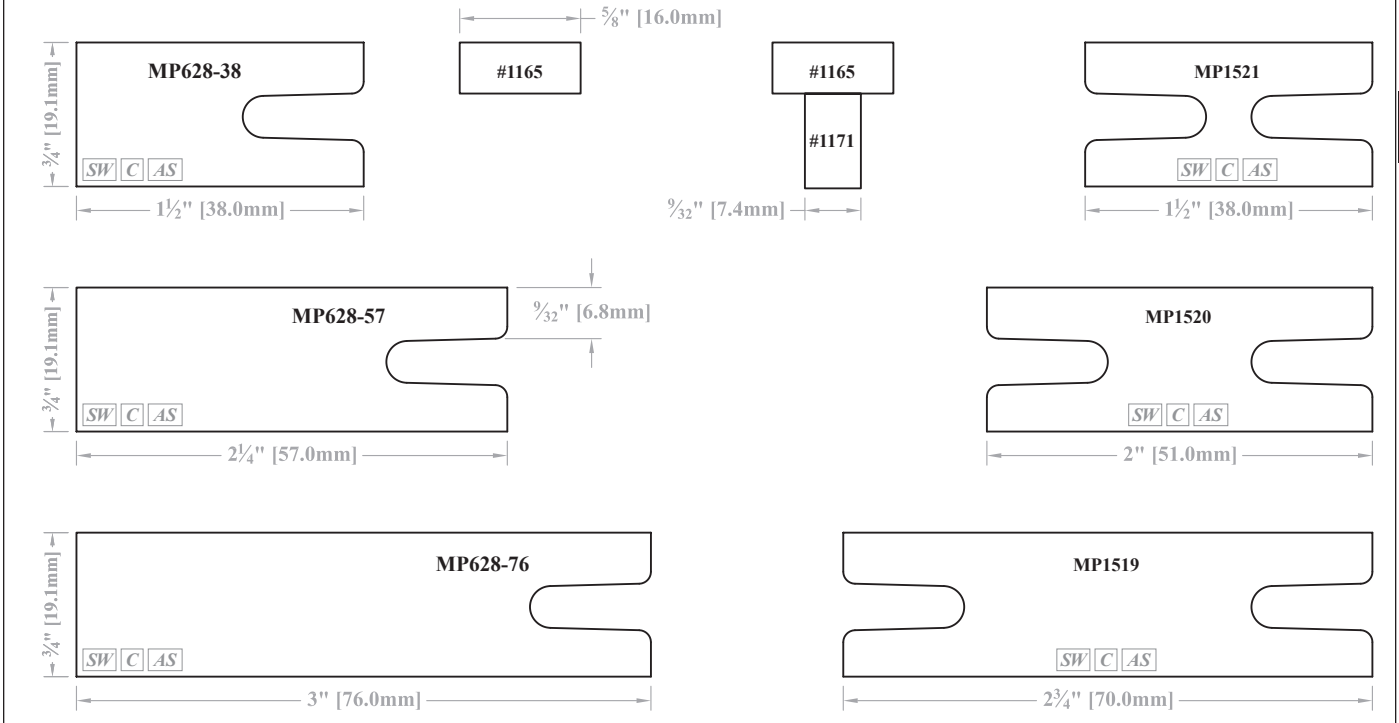

MP629 Family

Center Stiles & Rails will look like these profiles.

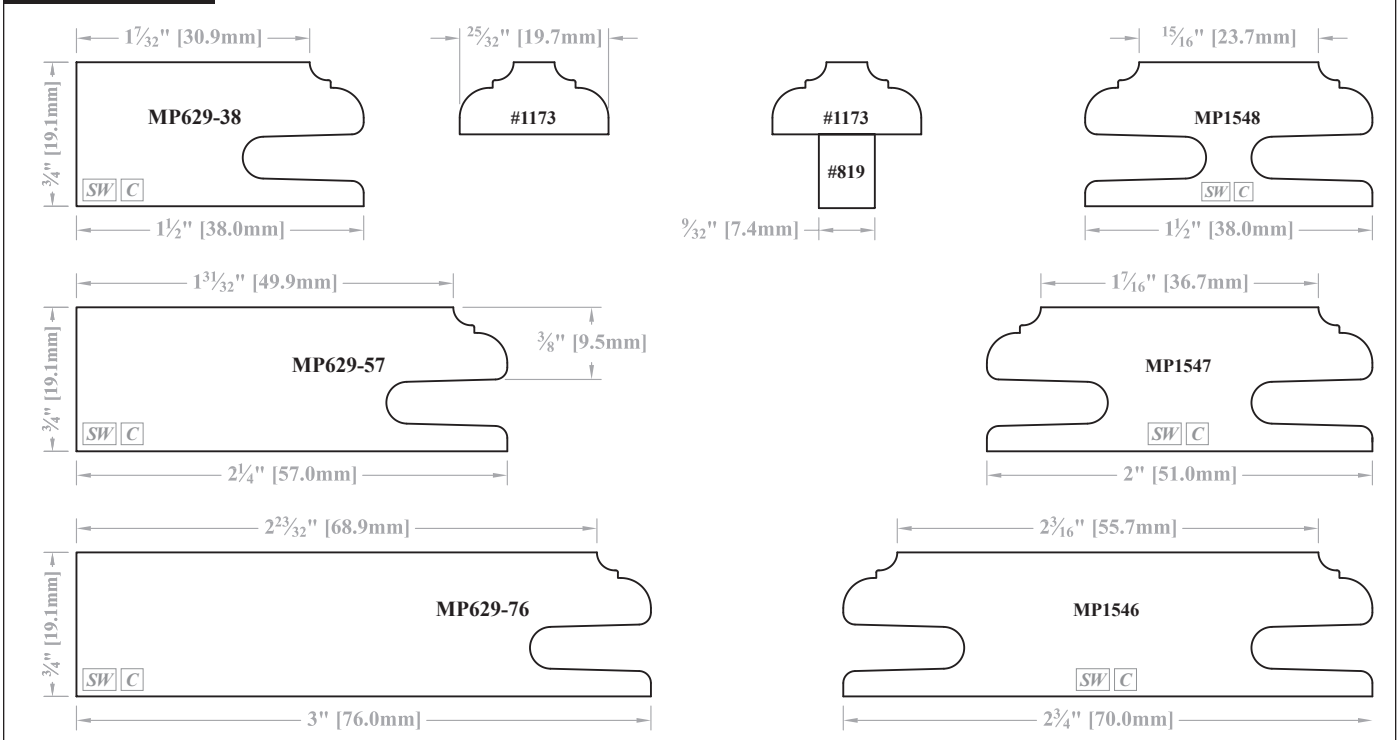

SW = Available in Solid Wood.

FM = Available for French Miter Doors.

C = Available for Convex/Concave products.

AS = Available on Adventure Series Doors.

► For PRICING ► See Section E.9 in our current Wholesale Pricing Catalog.

Profile Options

Stile & Rail - "Mitered" Mortise & Tenon Joinery - MP600/MP6000 Series

Mitered Stile & Rail Profiles with Matching Mullion Stock

MP632 Family

Center Stiles & Rails will look like these profiles.

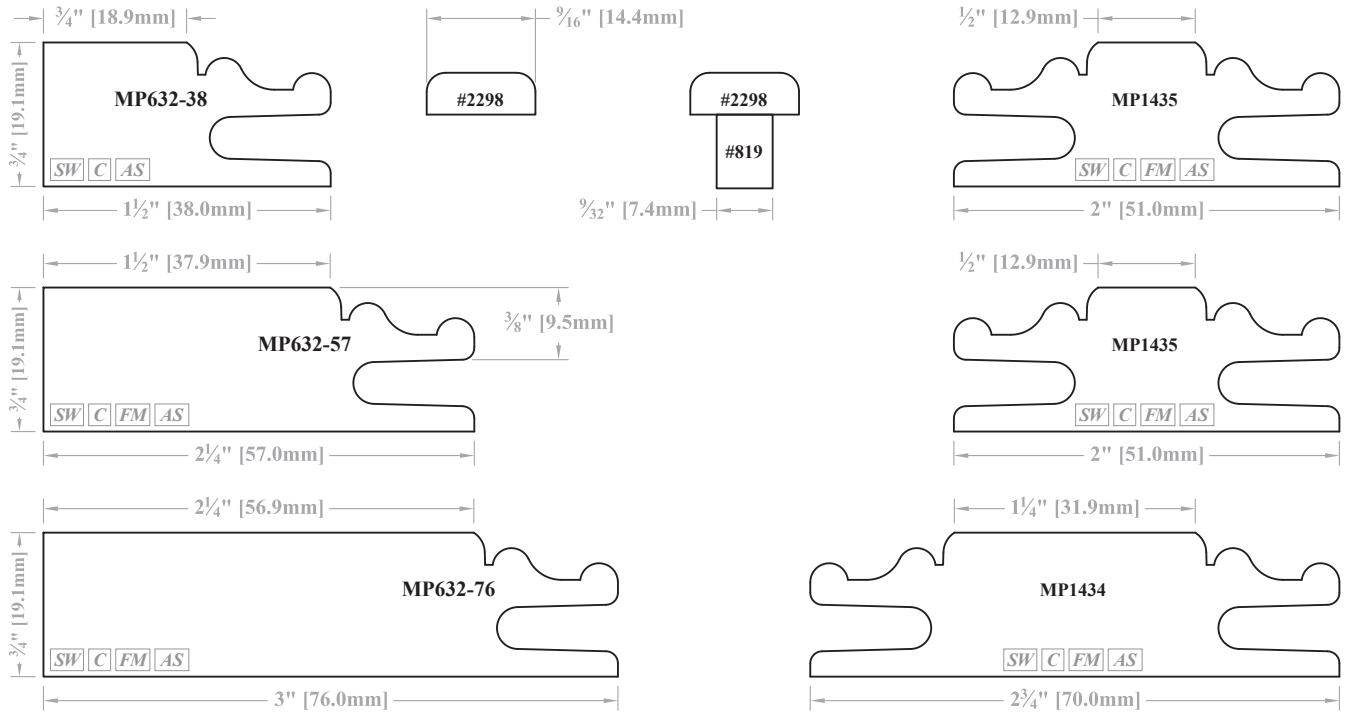

MP633 Family

Center Stiles & Rails will look like these profiles.

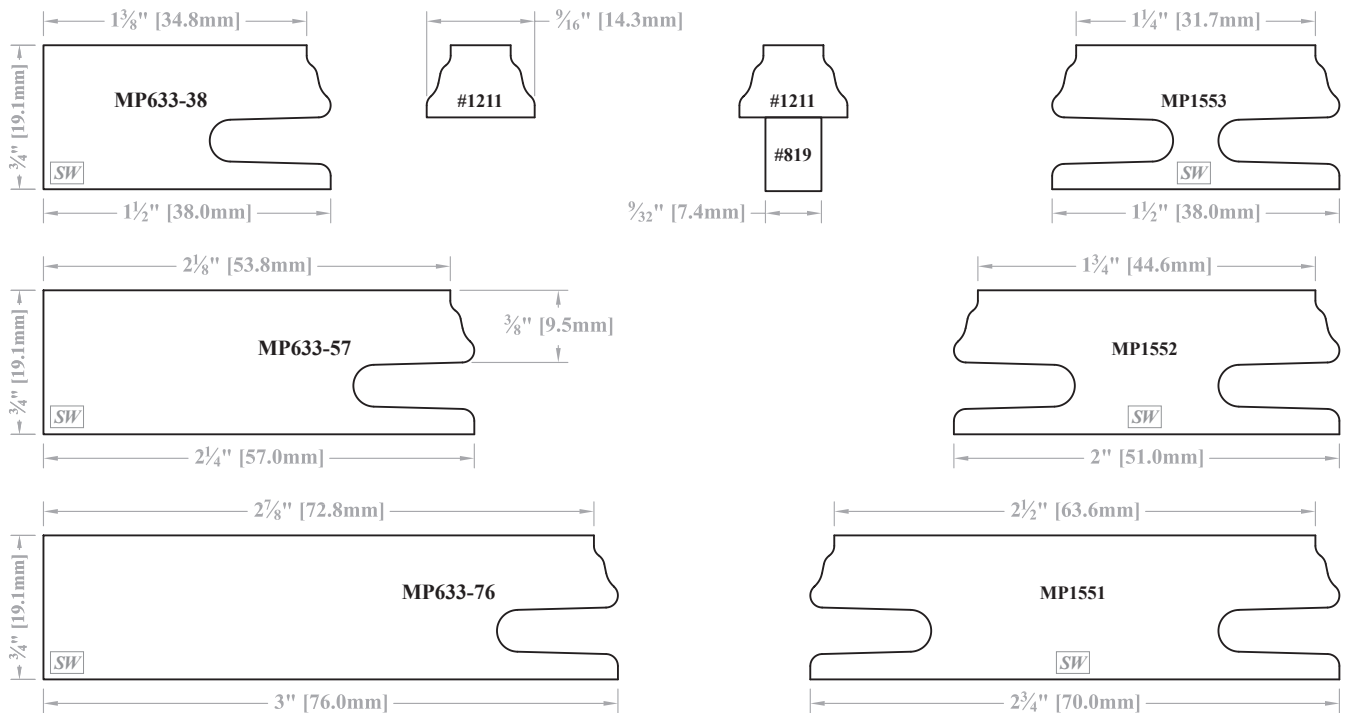

SW = Available in Solid Wood.

FM = Available for French Miter Doors.

C = Available for Convex/Concave products.

AS = Available on Adventure Series Doors.

► For PRICING ► See Section E.9 in our current Wholesale Pricing Catalog.

Mitered Stile & Rail Profiles with Matching Mullion Stock

MP634 Family

Center Stiles & Rails will look like these profiles.

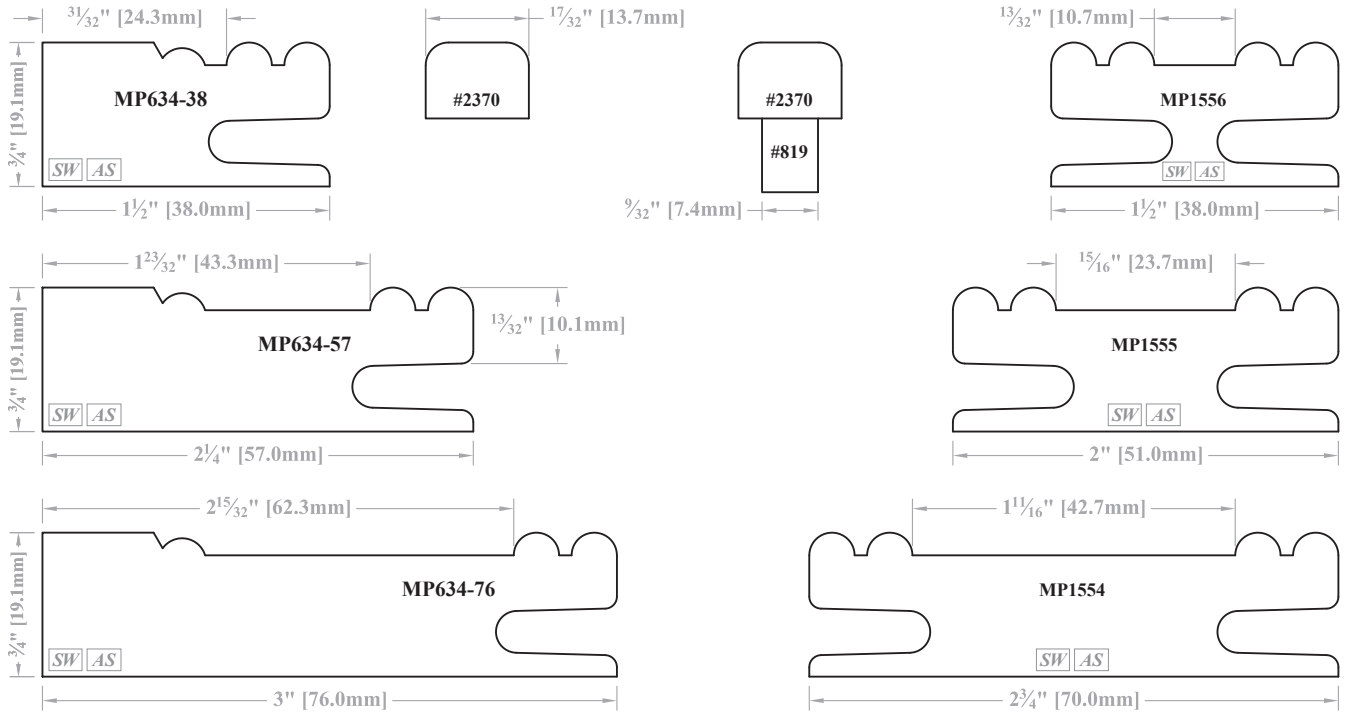

MP635 Family

Center Stiles & Rails will look like these profiles.

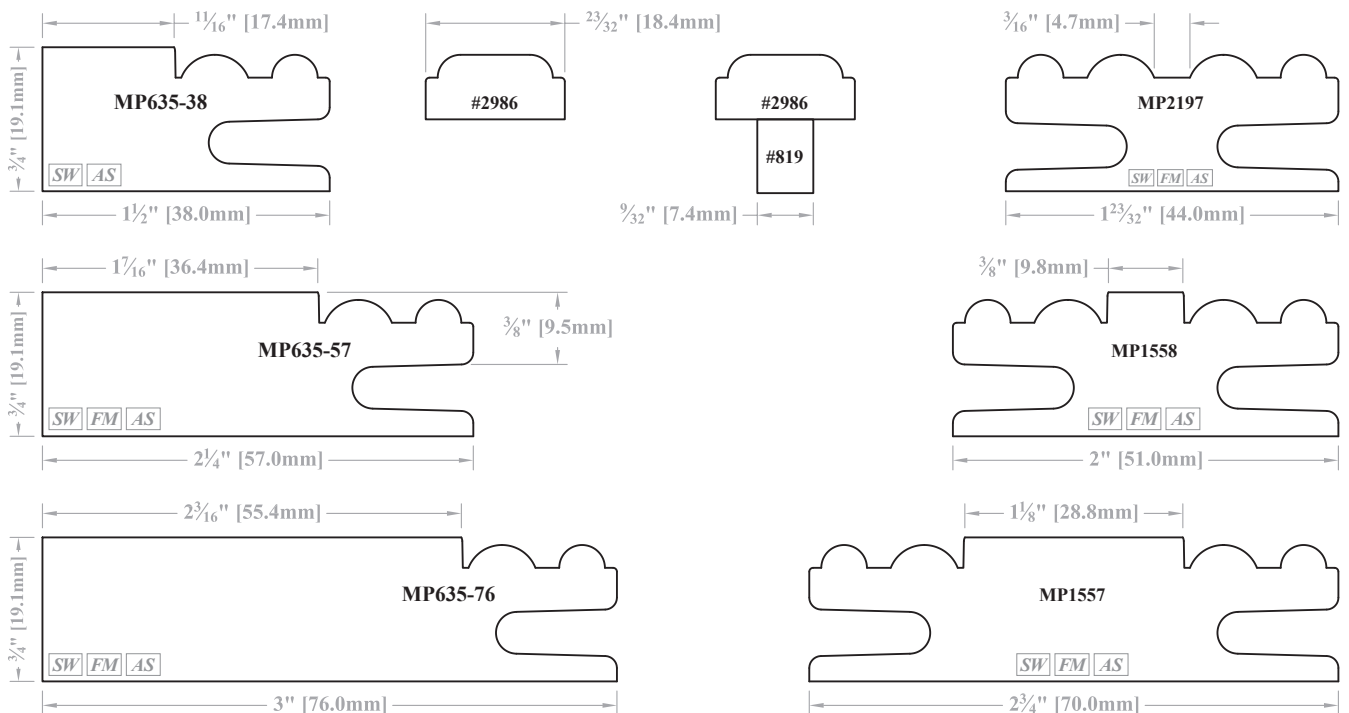

SW = Available in Solid Wood.

FM = Available for French Miter Doors.

C = Available for Convex/Concave products.

AS = Available on Adventure Series Doors.

► For PRICING ► See Section E.9 in our current Wholesale Pricing Catalog.

Profile Options

Stile & Rail - "Mitered" Mortise & Tenon Joinery - MP600/MP6000 Series

Mitered Stile & Rail Profiles with Matching Mullion Stock

MP636 Family

Center Stiles & Rails will look like these profiles.

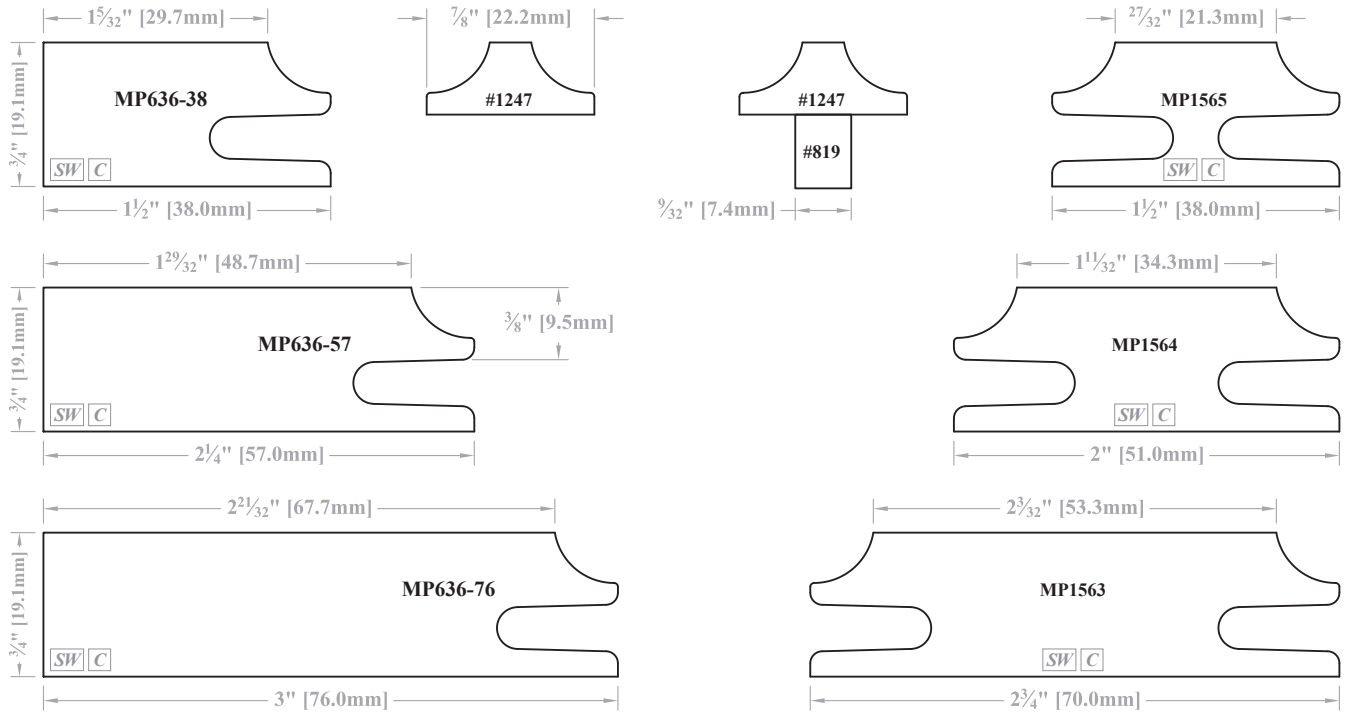

MP637 Family

See Profile Options notes in Section B.12 for alternative mullion.

Center Stiles & Rails will look like these profiles.

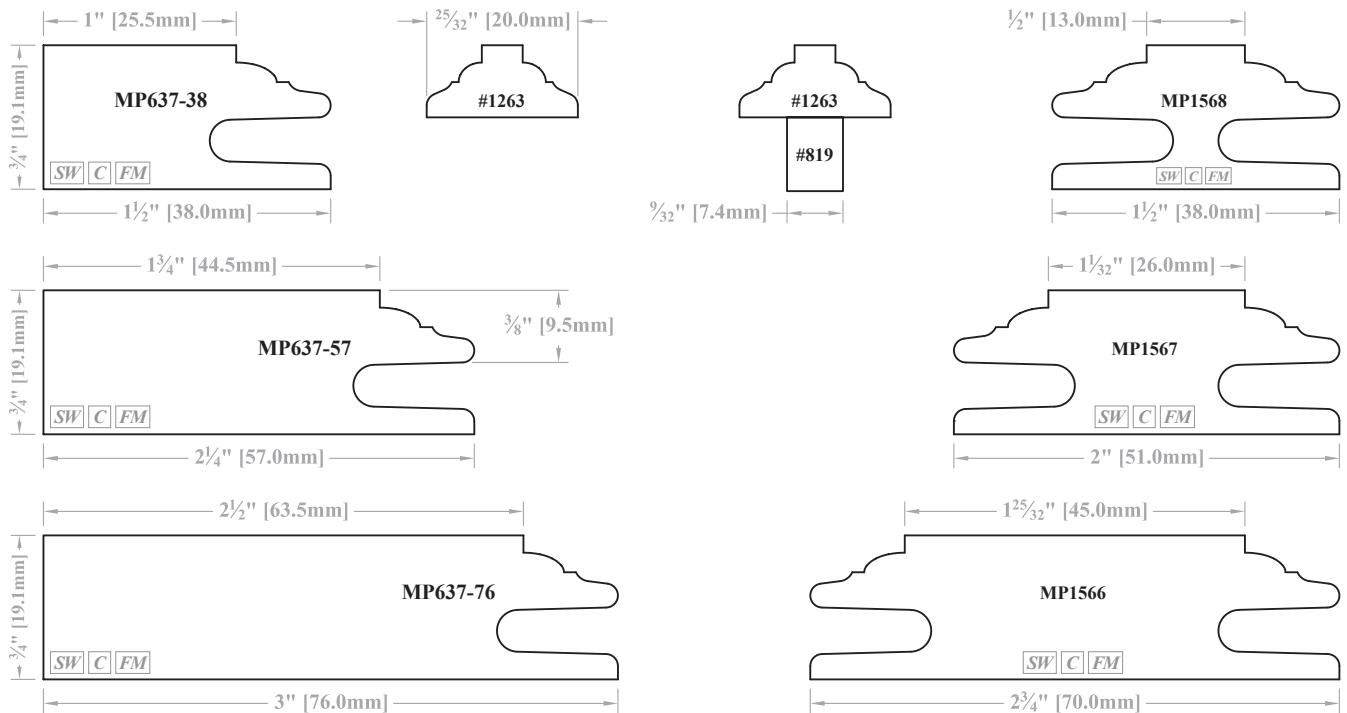

SW = Available in Solid Wood.

FM = Available for French Miter Doors.

C = Available for Convex/Concave products.

AS = Available on Adventure Series Doors.

► For PRICING ► See Section E.9 in our current Wholesale Pricing Catalog.

Mitered Stile & Rail Profiles with Matching Mullion Stock

MP638 Family

Center Stiles & Rails will look like these profiles.

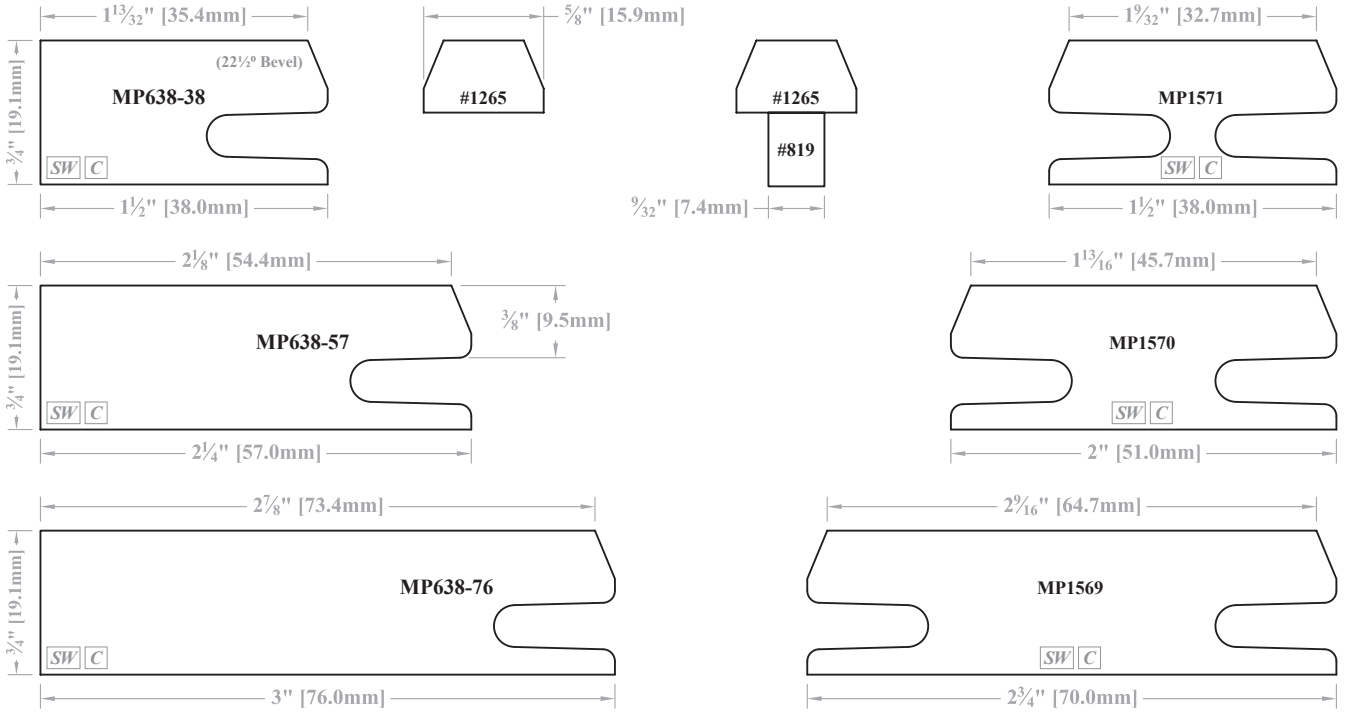

MP639 Family

Center Stiles & Rails will look like these profiles.

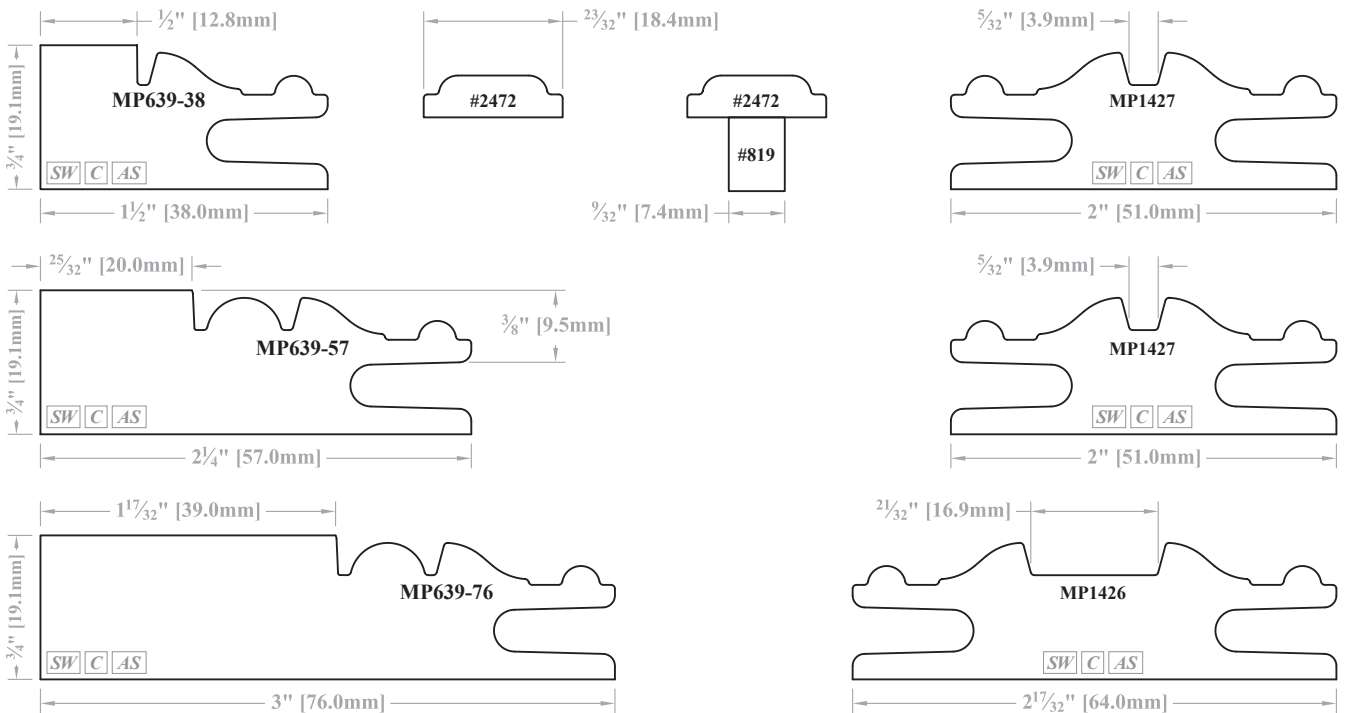

SW = Available in Solid Wood.

FM = Available for French Miter Doors.

C = Available for Convex/Concave products.

AS = Available on Adventure Series Doors.

► For PRICING ► See Section E.9 in our current Wholesale Pricing Catalog.

Profile Options

Stile & Rail - "Mitered" Mortise & Tenon Joinery - MP600/MP6000 Series

Mitered Stile & Rail Profiles with Matching Mullion Stock

MP640 Family

Center Stiles & Rails will look like these profiles.

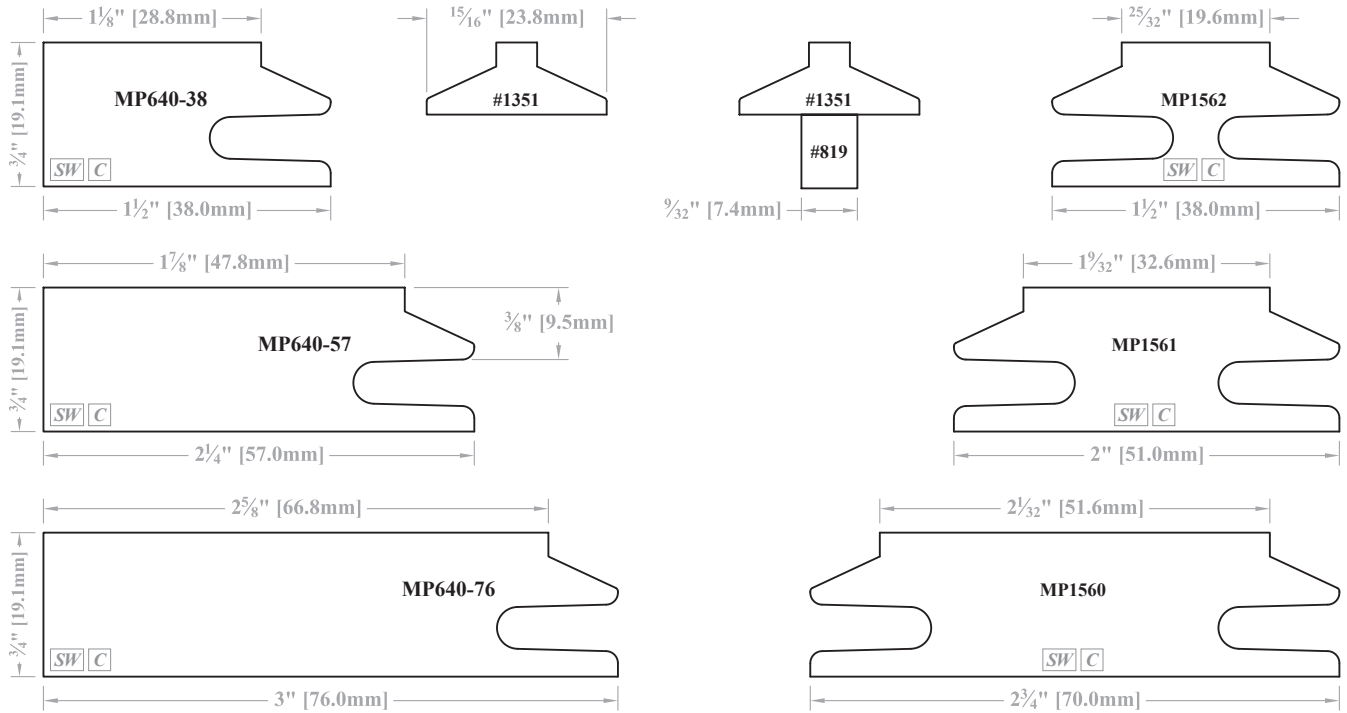

MP641 Family

Center Stiles & Rails will look like these profiles.

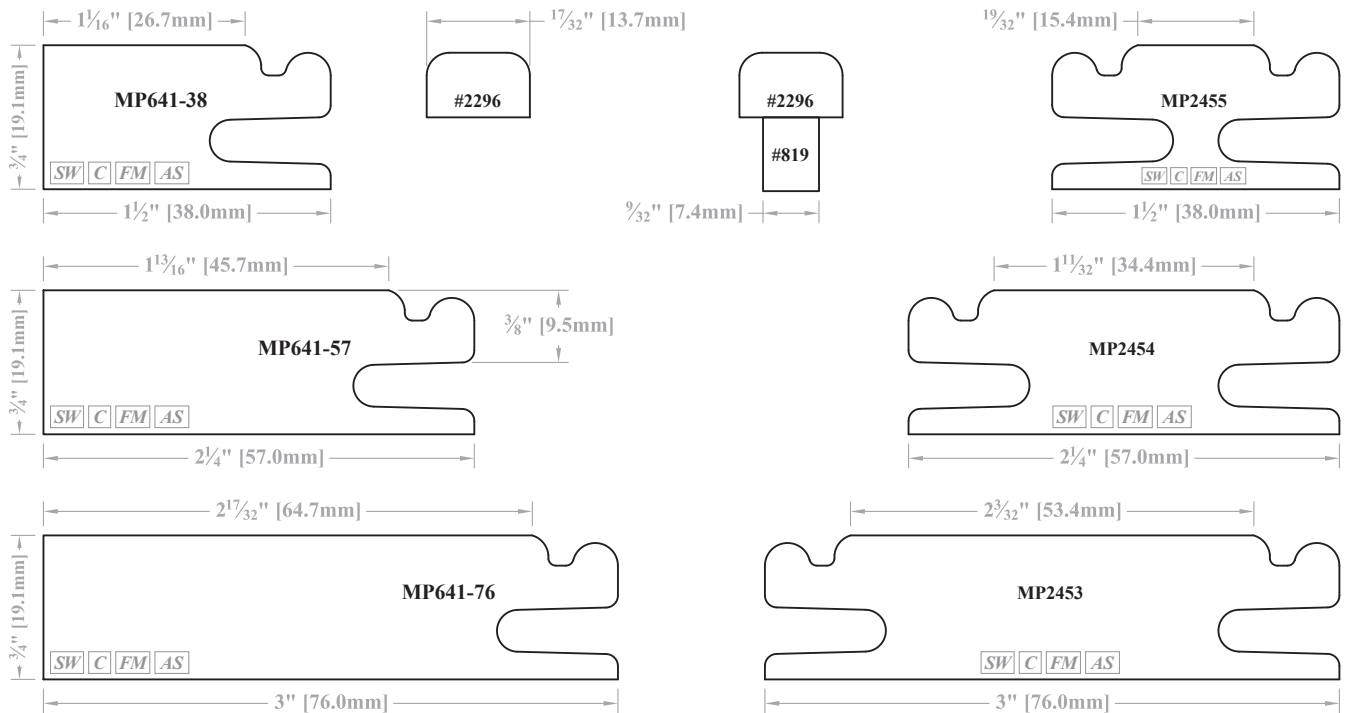

SW = Available in Solid Wood.

FM = Available for French Miter Doors.

C = Available for Convex/Concave products.

AS = Available on Adventure Series Doors.

► For PRICING ► See Section E.9 in our current Wholesale Pricing Catalog.

Mitered Stile & Rail Profiles with Matching Mullion Stock

MP642 Family

Center Stiles & Rails will look like these profiles.

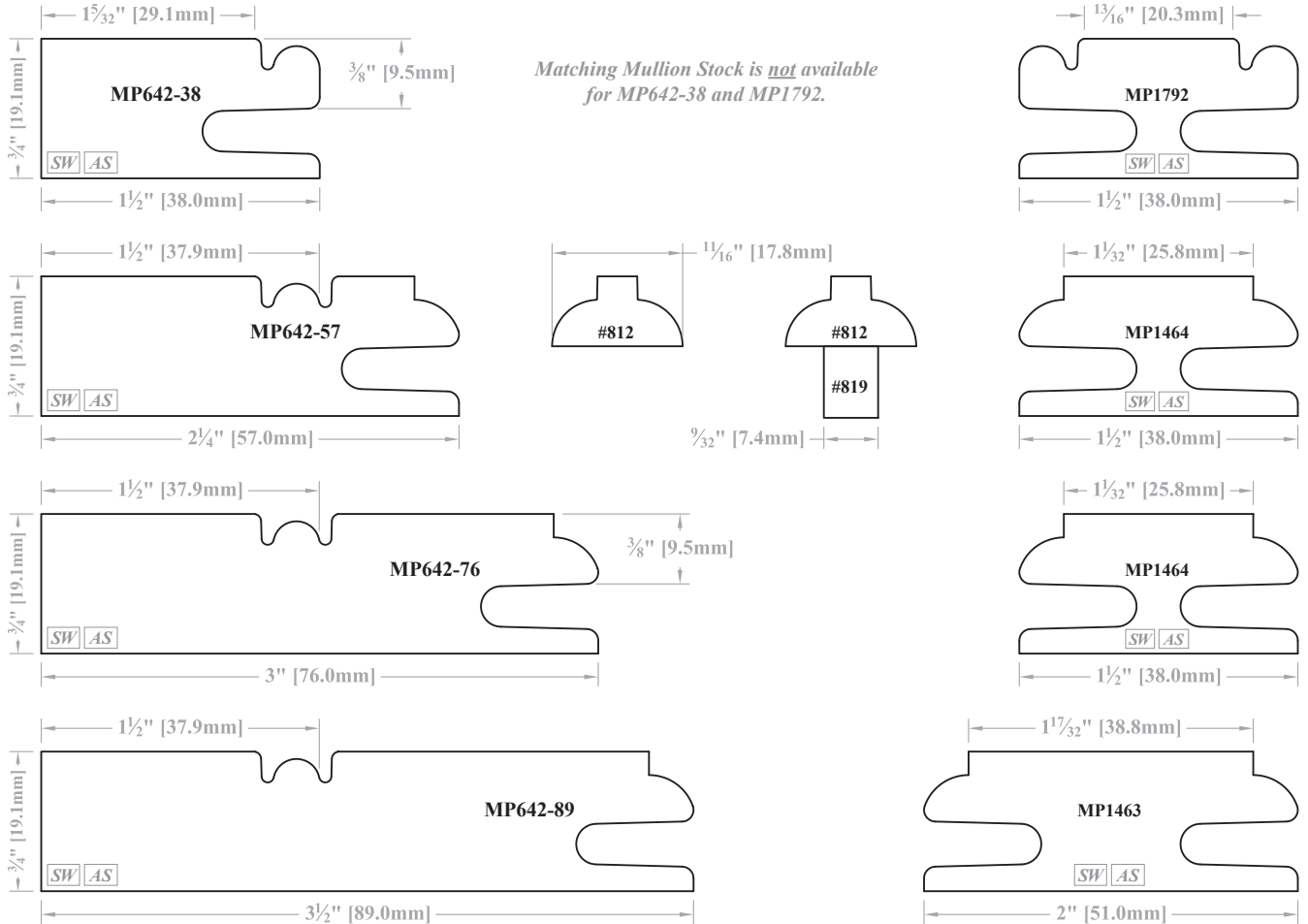

This family was created to simulate the look of a face frame and inset door.

SW = Available in Solid Wood. FM = Available for French Miter Doors. C = Available for Convex/Concave products. AS = Available on Adventure Series Doors.

► For PRICING ► See Section E.9 in our current Wholesale Pricing Catalog.

Profile Options

Stile & Rail - "Mitered" Mortise & Tenon Joinery - MP600/MP6000 Series

Mitered Stile & Rail Profiles with Matching Mullion Stock

MP643 Family

Center Stiles & Rails will look like these profiles.

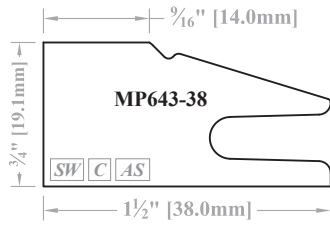

Matching Mullion Stock is not available for any of these profiles.

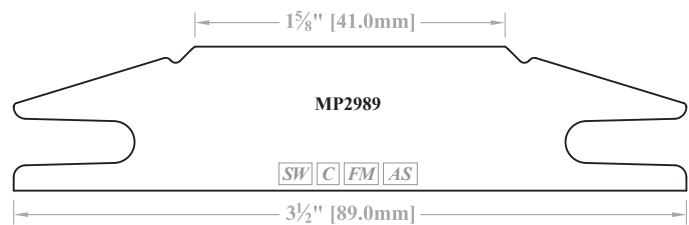
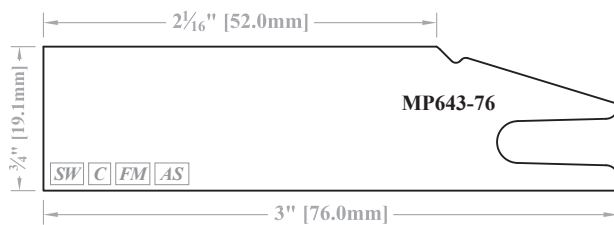
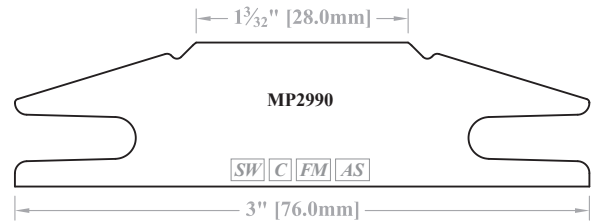
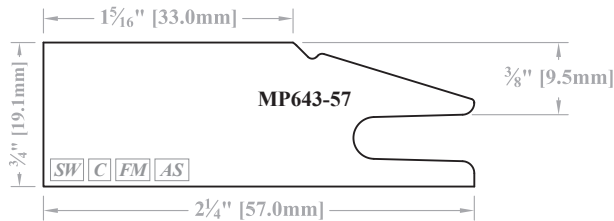
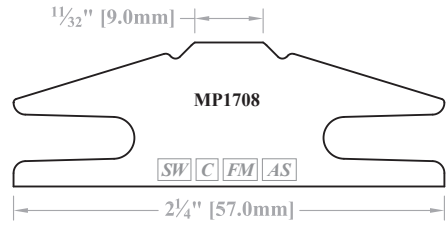

MP646 Family

Center Stiles & Rails will look like these profiles.

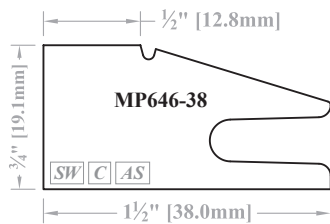

Matching Mullion Stock is not available for any of these profiles.

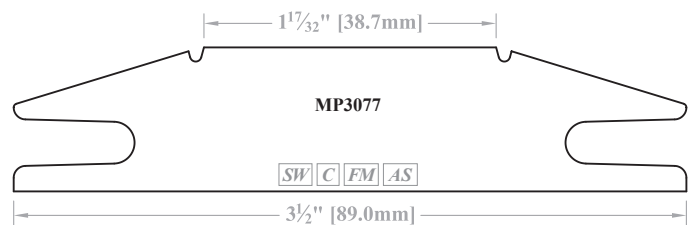
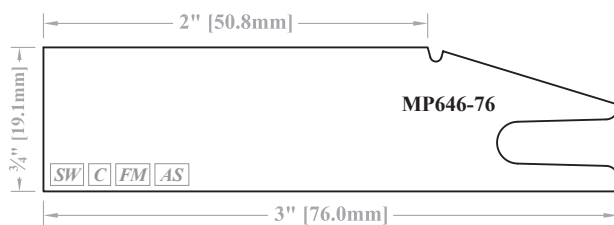
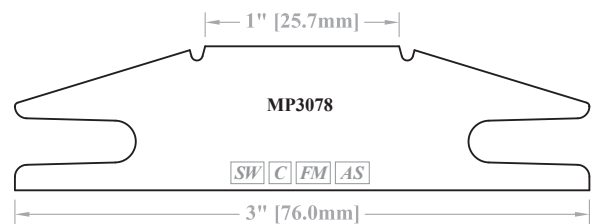
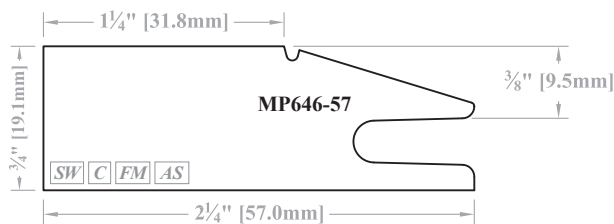
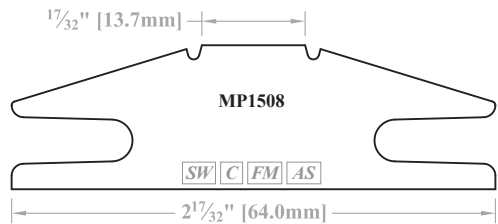

SW = Available in Solid Wood.

FM = Available for French Miter Doors.

C = Available for Convex/Concave products.

AS = Available on Adventure Series Doors.

► For PRICING ► See Section E.9 in our current Wholesale Pricing Catalog.

Mitered Stile & Rail Profiles with Matching Mullion Stock

MP644 Family

Center Stiles & Rails will look like these profiles.

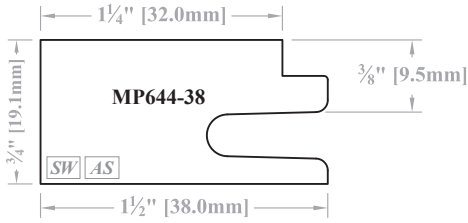

Matching Mullion Stock is not available for MP644-38 and MPI1797

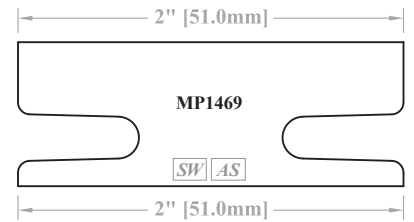
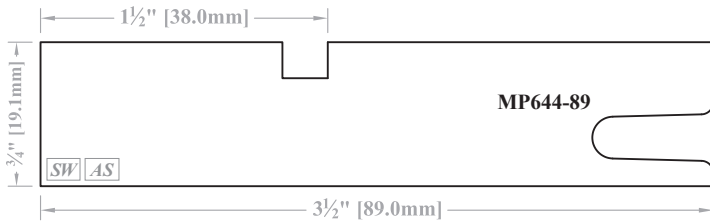
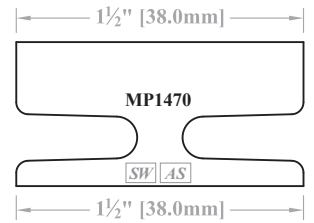
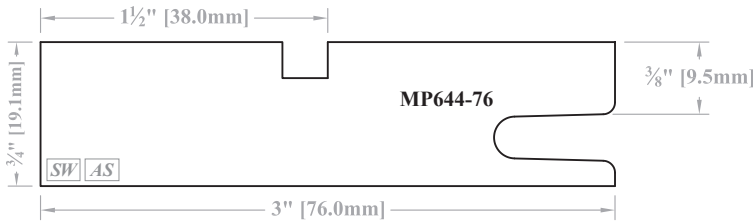
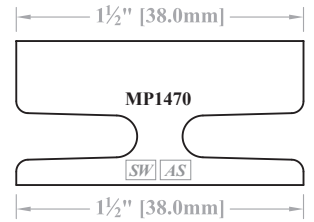
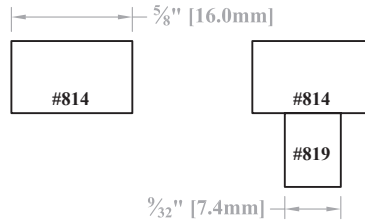
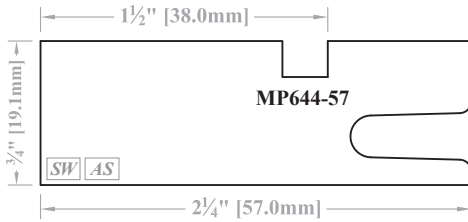
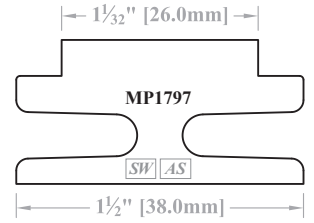

This family was created to simulate the look of a face frame and inset door.

E

SW = Available in Solid Wood. **FM** = Available for French Miter Doors. **C** = Available for Convex/Concave products. **AS** = Available on Adventure Series Doors.

► For PRICING ► See Section **E.9** in our current Wholesale Pricing Catalog.

Profile Options

Stile & Rail - "Mitered" Mortise & Tenon Joinery - MP600/MP6000 Series

Mitered Stile & Rail Profiles with Matching Mullion Stock

MP645 Family

Center Stiles & Rails will look like these profiles.

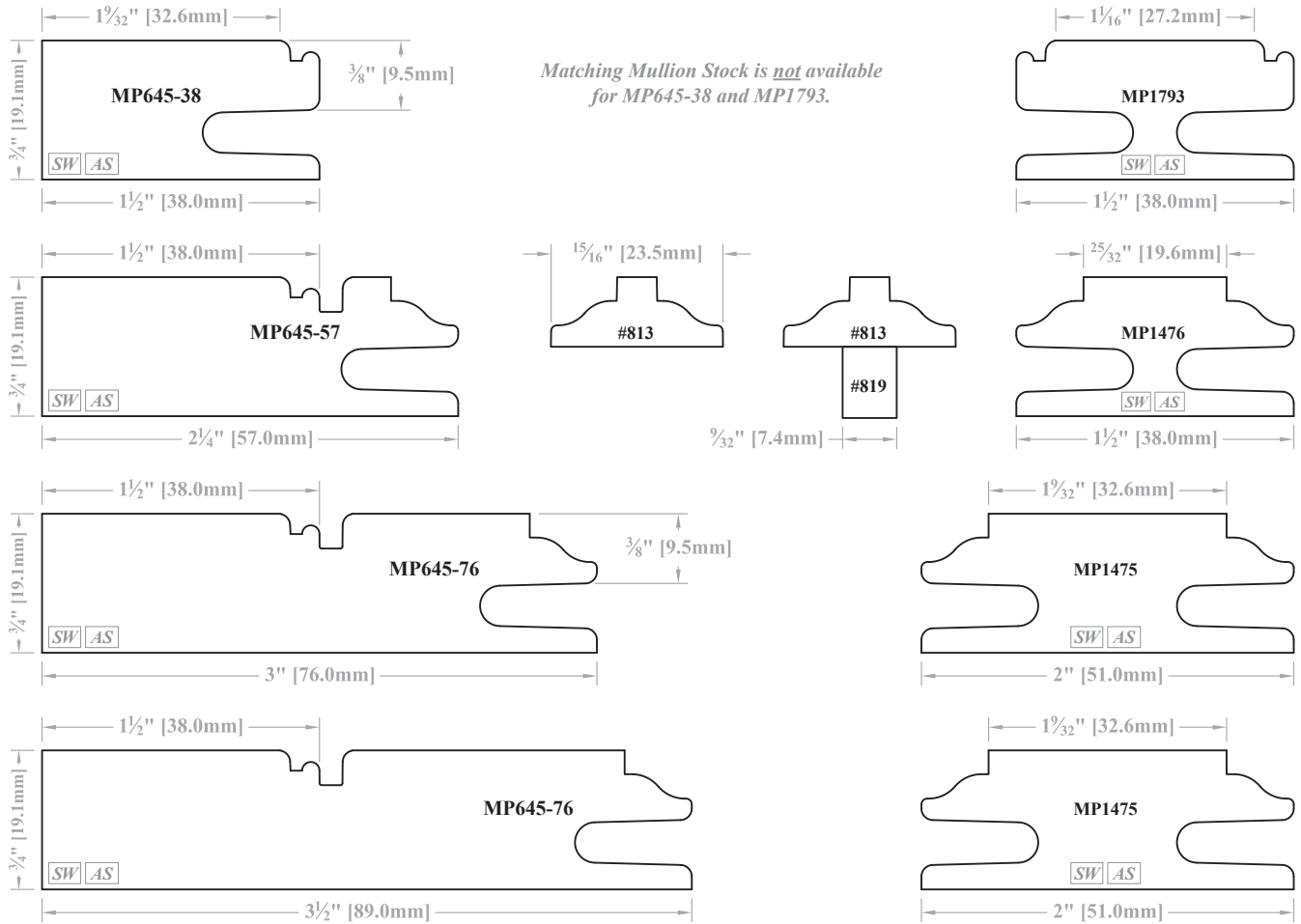

Matching Mullion Stock is not available for MP645-38 and MP1793.

This family was created to simulate the look of a face frame and inset door.

SW = Available in Solid Wood. FM = Available for French Miter Doors. C = Available for Convex/Concave products. AS = Available on Adventure Series Doors.

► For PRICING ► See Section E.9 in our current Wholesale Pricing Catalog.

Mitered Stile & Rail Profiles with Matching Mullion Stock

MP648 Family

Center Stiles & Rails will look like these profiles.

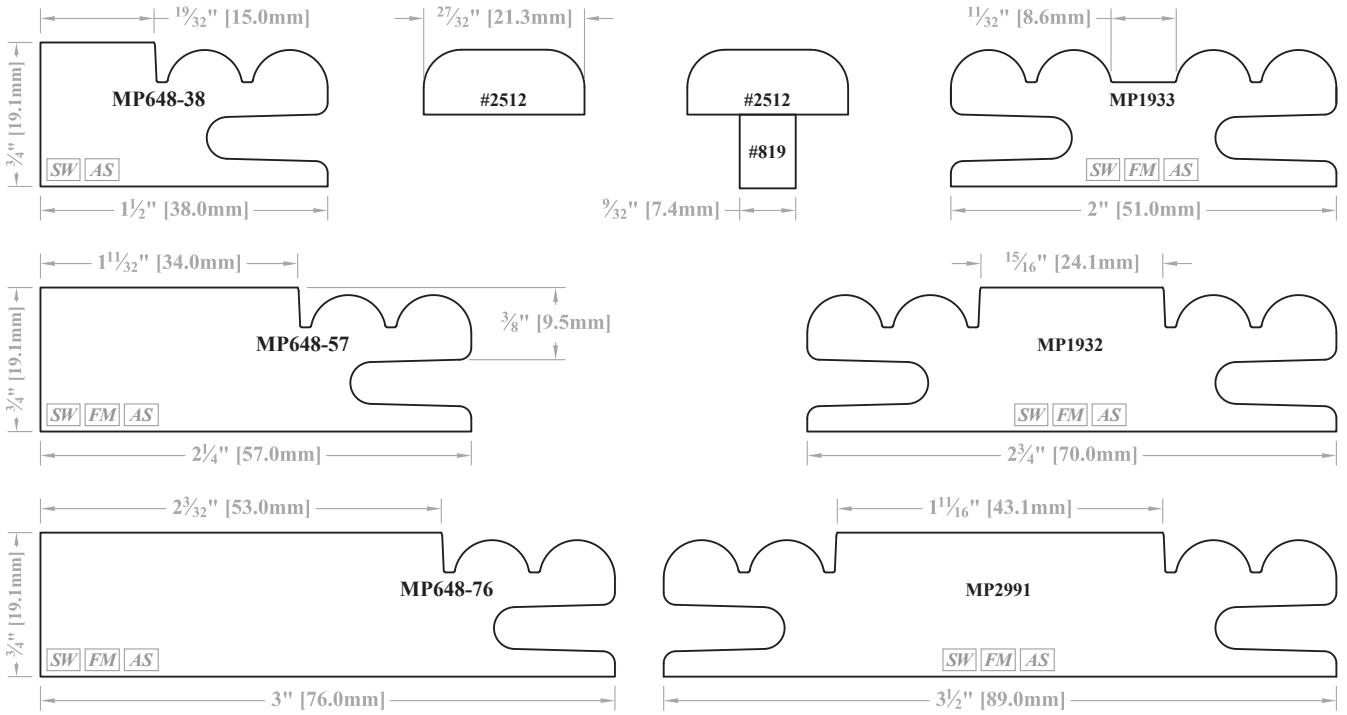

E

SW = Available in Solid Wood. FM = Available for French Miter Doors. C = Available for Convex/Concave products. AS = Available on Adventure Series Doors.

► For PRICING ► See Section E.9 in our current Wholesale Pricing Catalog.

Profile Options

Stile & Rail - "Mitered" Mortise & Tenon Joinery - MP600/MP6000 Series

Mitered Stile & Rail Profiles with Matching Mullion Stock

MP649 Family

* = Only available with an applied molding. See Notes.

Center Stiles & Rails will look like these profiles.

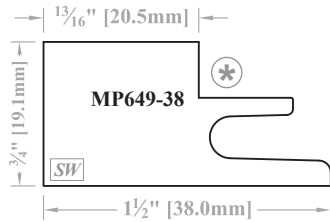

Matching Mullion Stock is not available for any of these profiles.

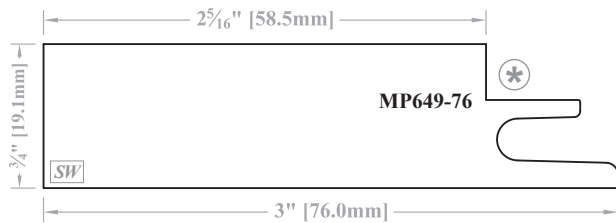
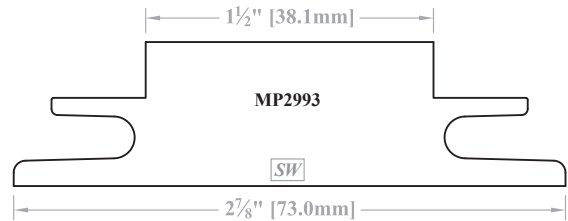
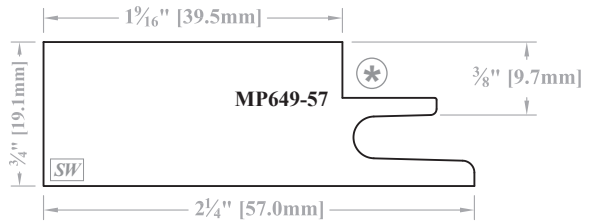
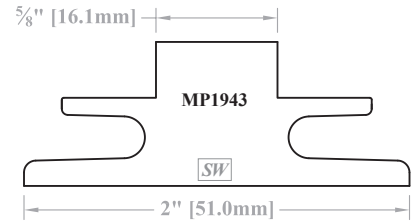

MP649-76 uses MP2992 for center stiles & rails as shown below.

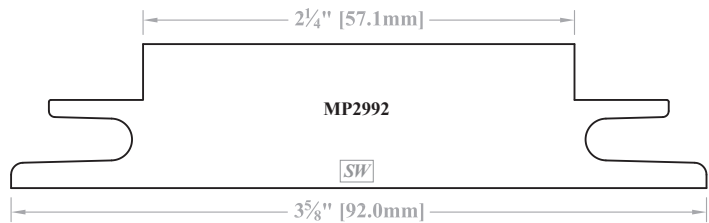

SW = Available in Solid Wood.

FM = Available for French Miter Doors.

C = Available for Convex/Concave products.

AS = Available on Adventure Series Doors.

► For PRICING ► See Section [E.9](#) in our current Wholesale Pricing Catalog.



Mitered Stile & Rail Profiles with Matching Mullion Stock

MP650 Family

Center Stiles & Rails will look like these profiles.

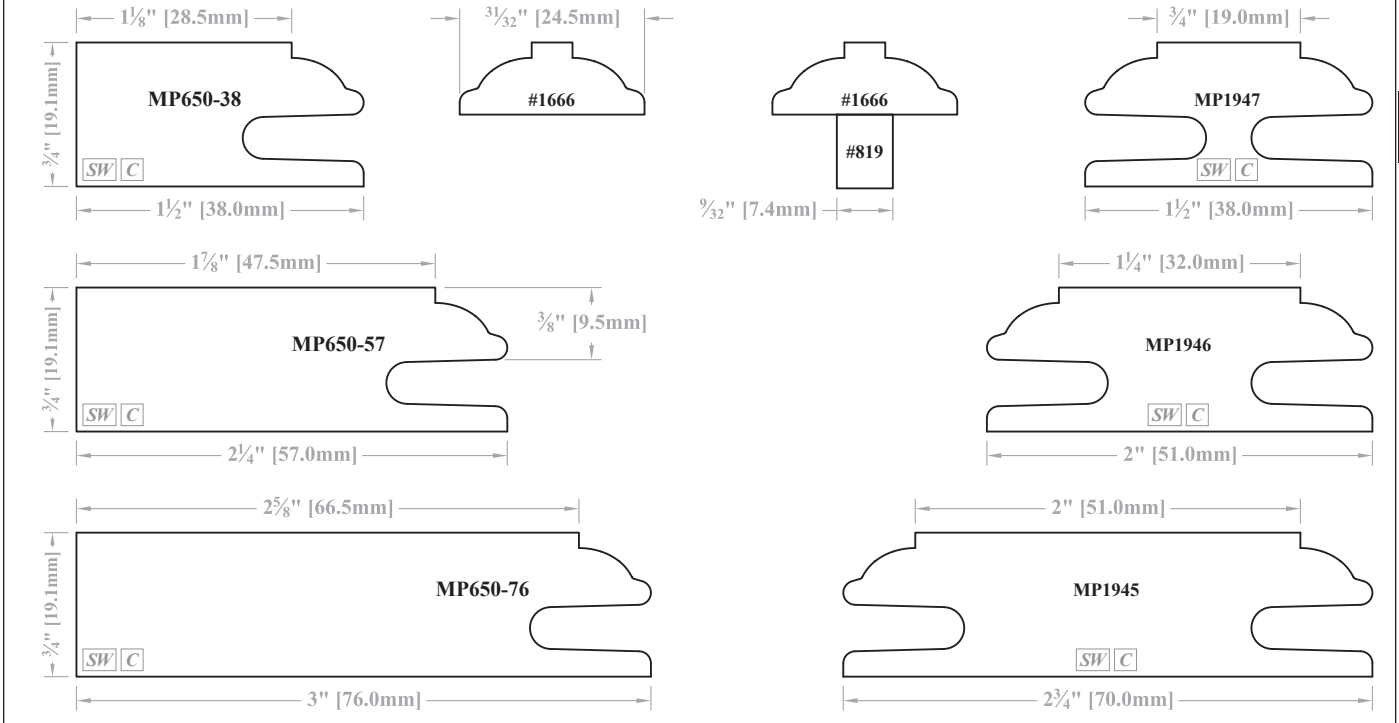

MP651 Family

(X) = Applied Molding Shelf, molding is optional

Center Stiles & Rails will look like these profiles.

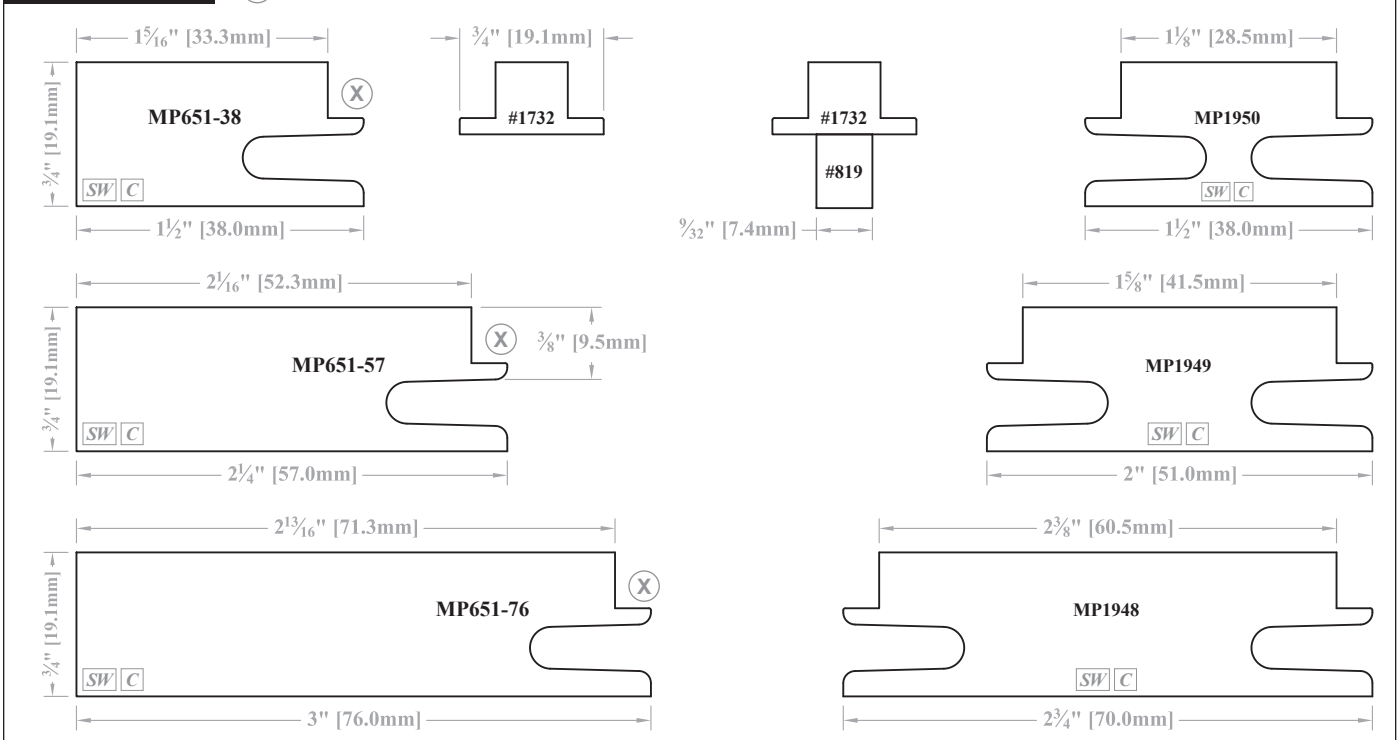

[SW] = Available in Solid Wood.

[FM] = Available for French Miter Doors.

[C] = Available for Convex/Concave products.

[AS] = Available on Adventure Series Doors.

► For PRICING ► See Section E.9 in our current Wholesale Pricing Catalog.

Profile Options

Stile & Rail - "Mitered" Mortise & Tenon Joinery - MP600/MP6000 Series

Mitered Stile & Rail Profiles with Matching Mullion Stock

MP652 Family

(X) = Applied Molding Shelf, molding is optional

Center Stiles & Rails will look like these profiles.

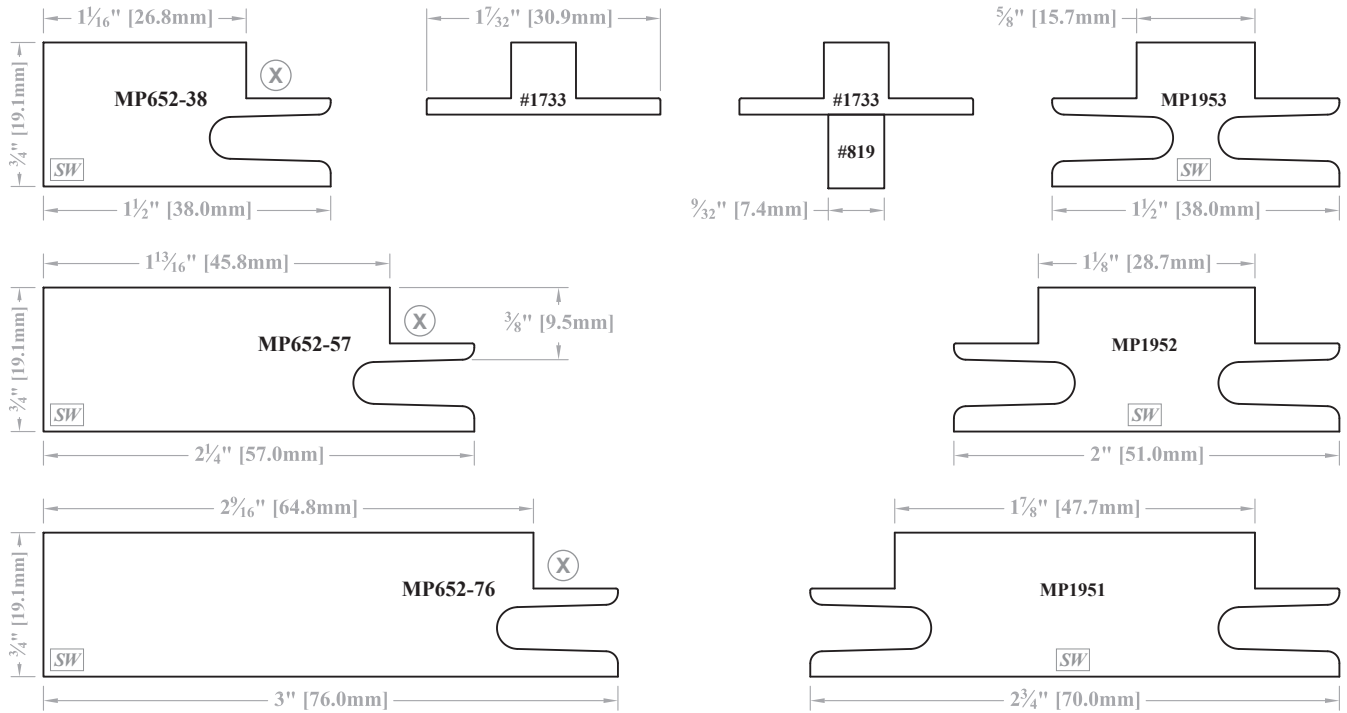

MP653 Family

(X) = Applied Molding Shelf, molding is optional

Center Stiles & Rails will look like these profiles.

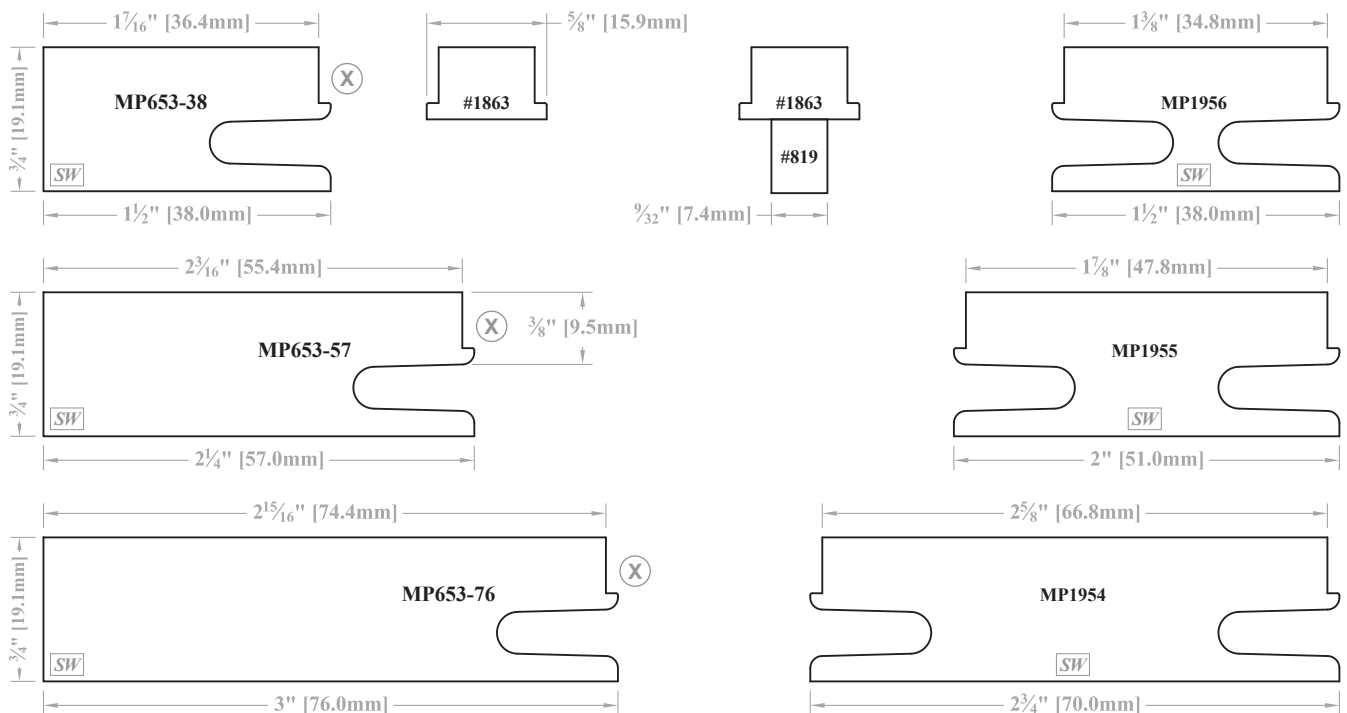

SW = Available in Solid Wood.

FM = Available for French Miter Doors.

C = Available for Convex/Concave products.

AS = Available on Adventure Series Doors.

► For PRICING ► See Section E.9 in our current Wholesale Pricing Catalog.

Mitered Stile & Rail Profiles with Matching Mullion Stock

MP654 Family

Center Stiles & Rails will look like these profiles.

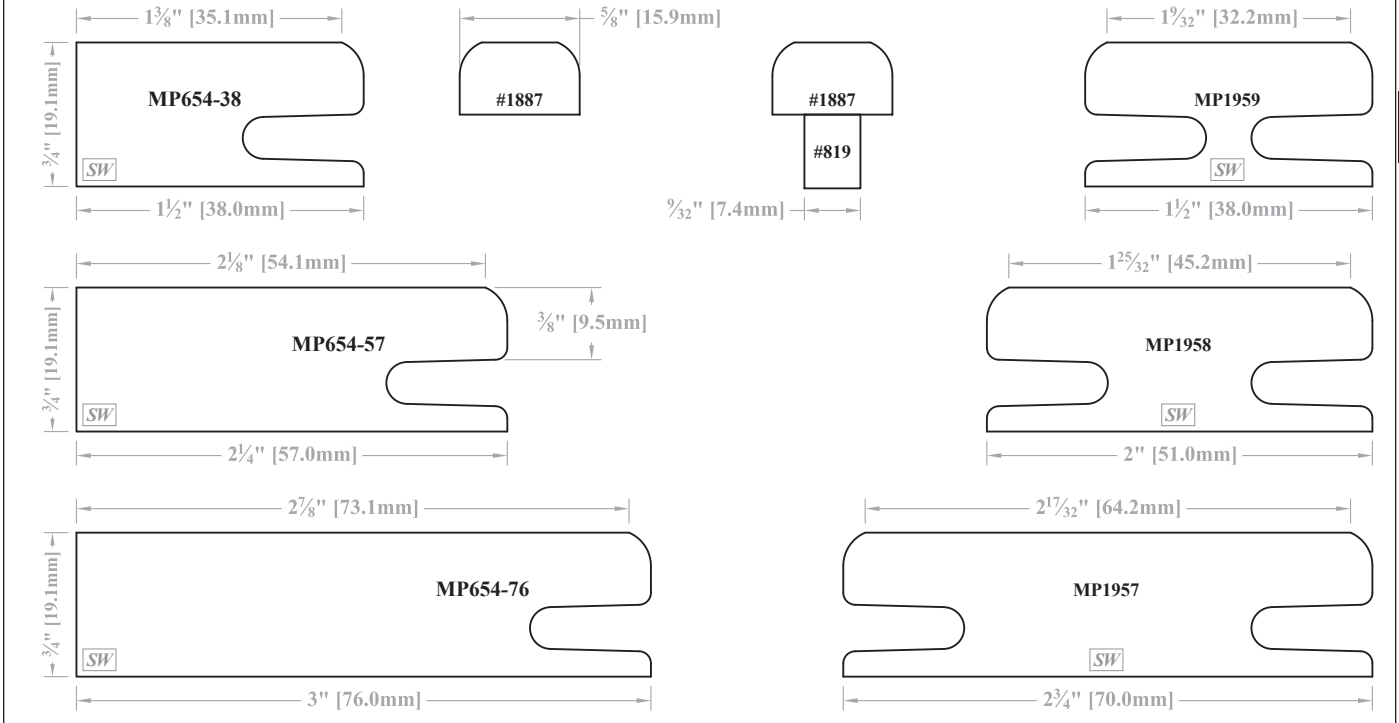

MP655 Family

Center Stiles & Rails will look like these profiles.

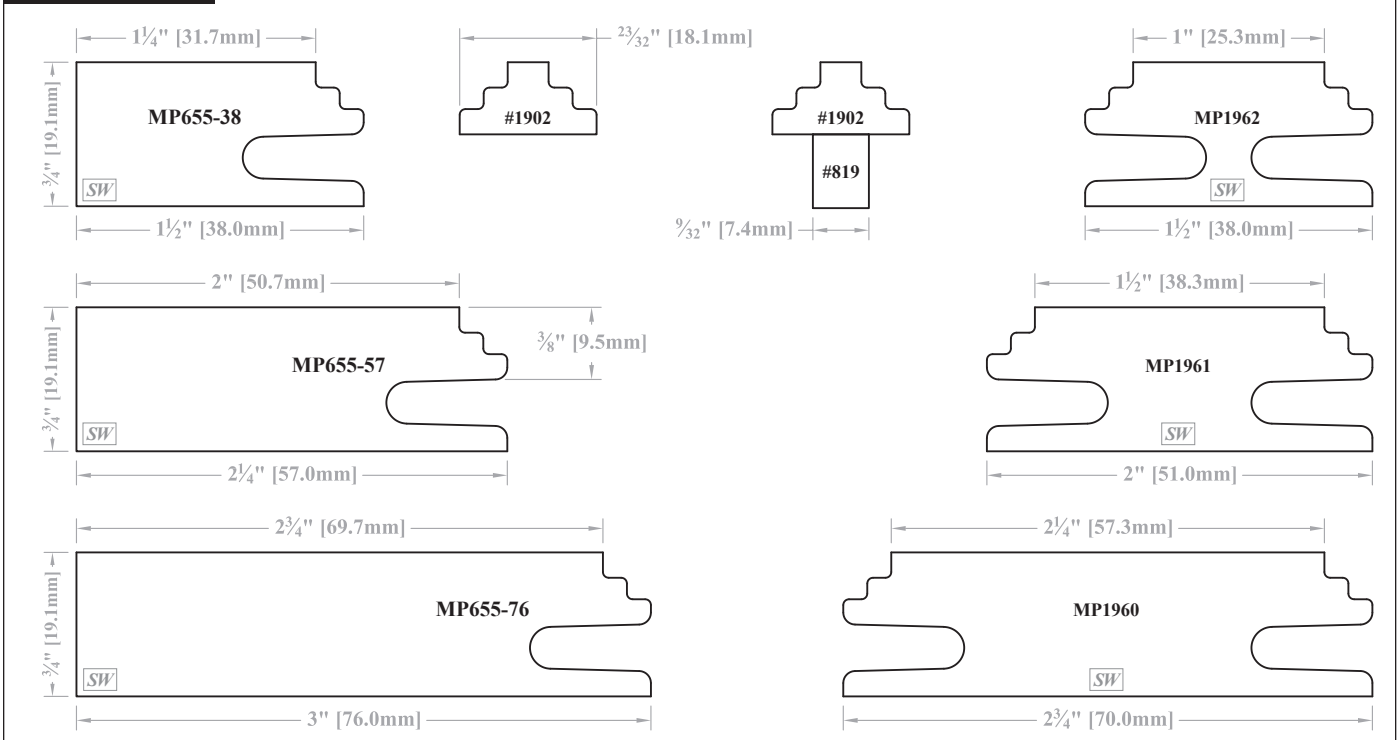

[SW] = Available in Solid Wood.

[FM] = Available for French Miter Doors.

[C] = Available for Convex/Concave products.

[AS] = Available on Adventure Series Doors.

► For PRICING ► See Section E.9 in our current Wholesale Pricing Catalog.

Profile Options

Stile & Rail - "Mitered" Mortise & Tenon Joinery - MP600/MP6000 Series

Mitered Stile & Rail Profiles with Matching Mullion Stock

MP656 Family

Center Stiles & Rails will look like these profiles.

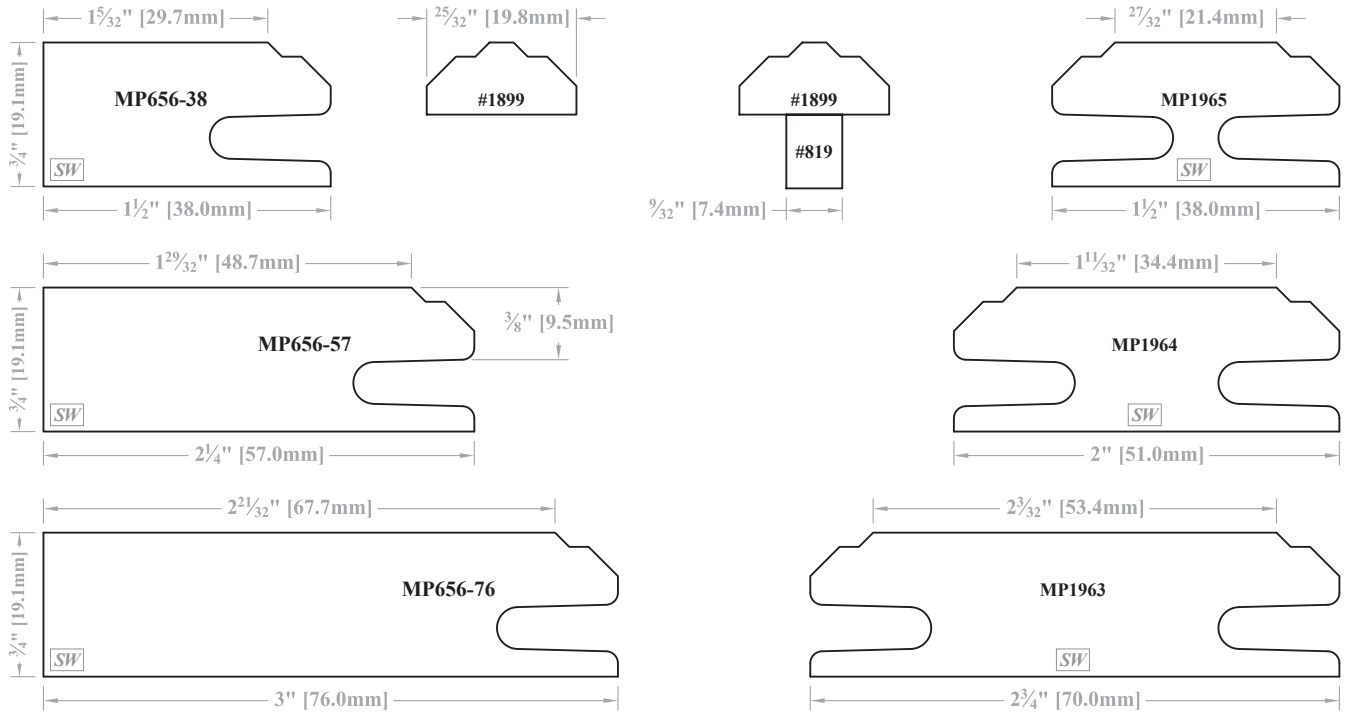

MP657 Family

Center Stiles & Rails will look like these profiles.

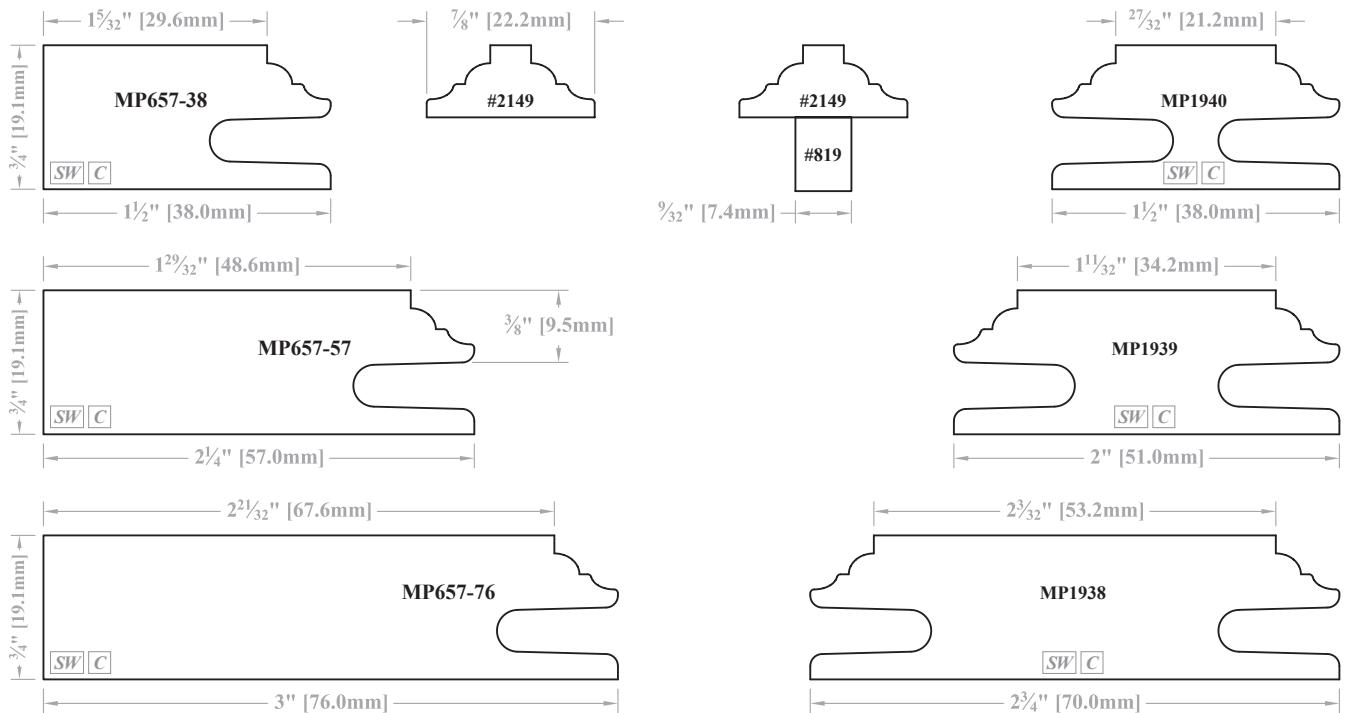

SW = Available in Solid Wood.

FM = Available for French Miter Doors.

C = Available for Convex/Concave products.

AS = Available on Adventure Series Doors.

► For PRICING ► See Section [E.9](#) in our current Wholesale Pricing Catalog.

Mitered Stile & Rail Profiles with Matching Mullion Stock

MP658 Family

Center Stiles & Rails will look like these profiles.

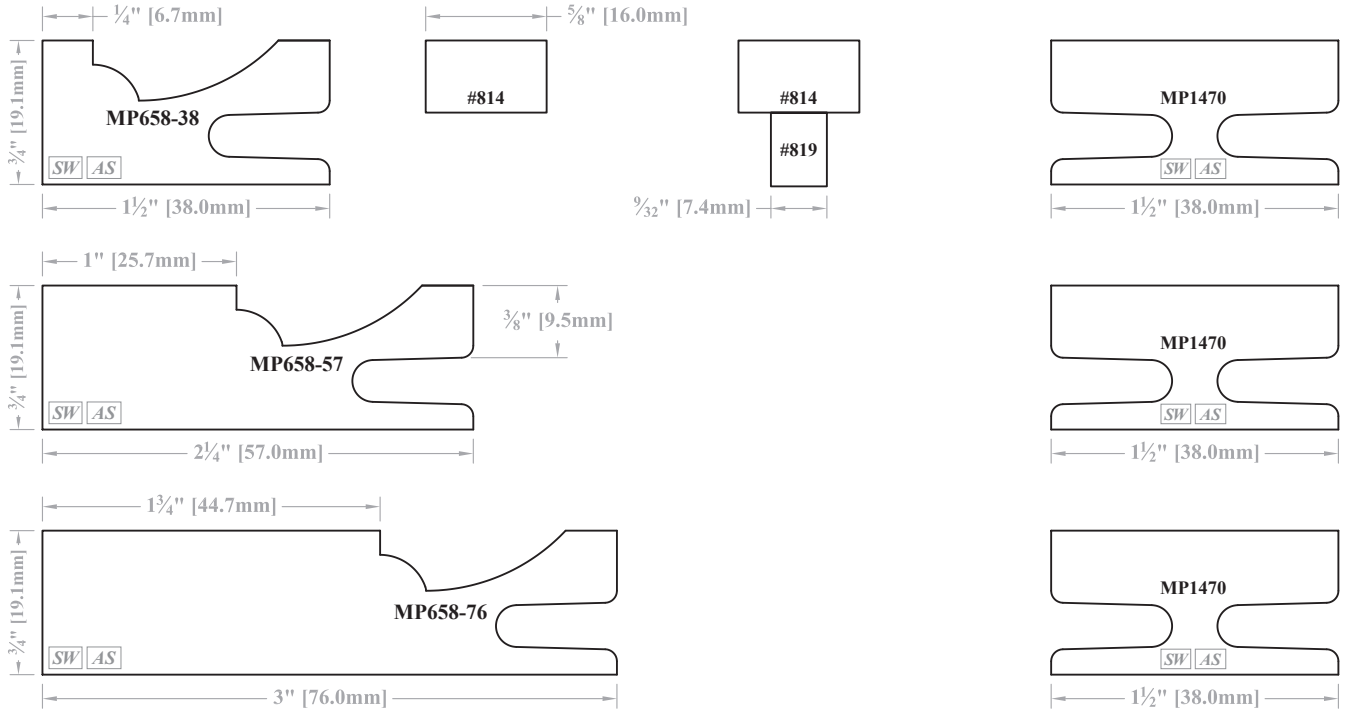

MP659 Family

Center Stiles & Rails will look like these profiles.

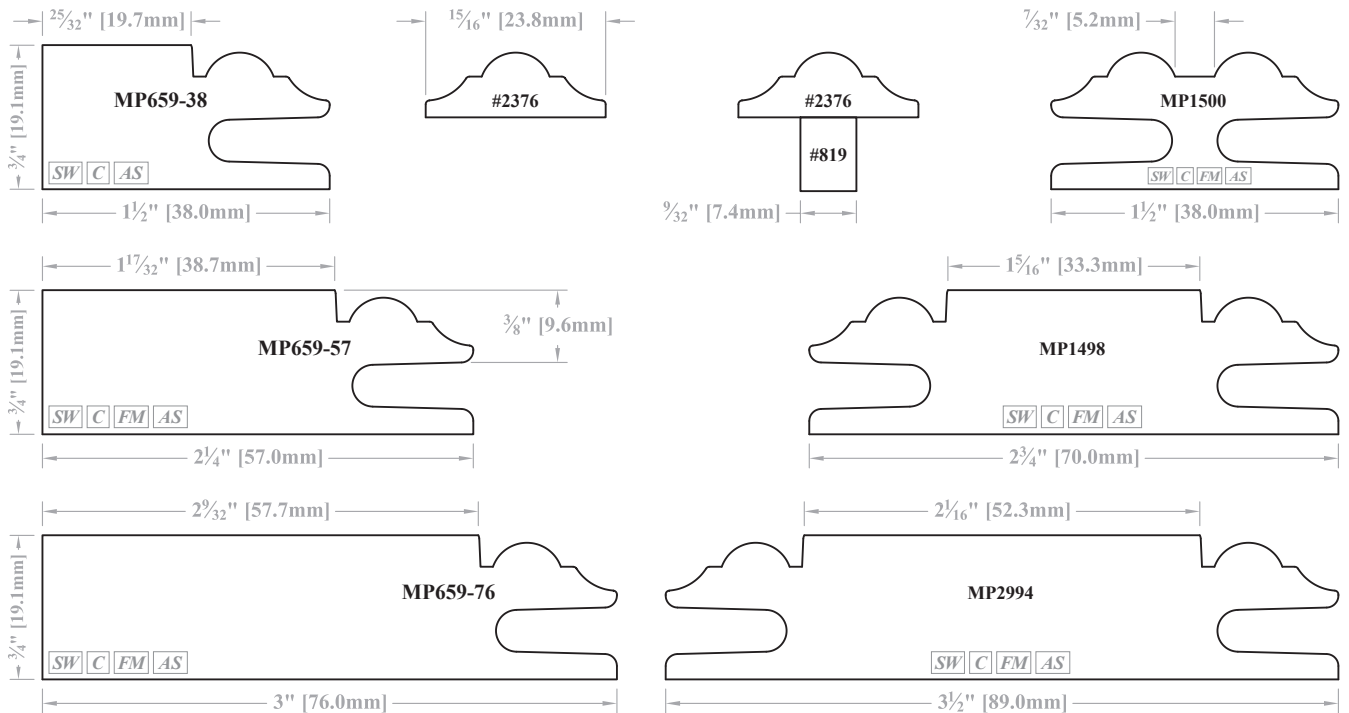

SW = Available in Solid Wood.

FM = Available for French Miter Doors.

C = Available for Convex/Concave products.

AS = Available on Adventure Series Doors.

► For PRICING ► See Section E.9 in our current Wholesale Pricing Catalog.

Profile Options

Stile & Rail - "Mitered" Mortise & Tenon Joinery - MP600/MP6000 Series

Mitered Stile & Rail Profiles with Matching Mullion Stock

MP660 Family

Molding is *not* included with this family and must be ordered separately.

Center Stiles & Rails will look like these profiles.

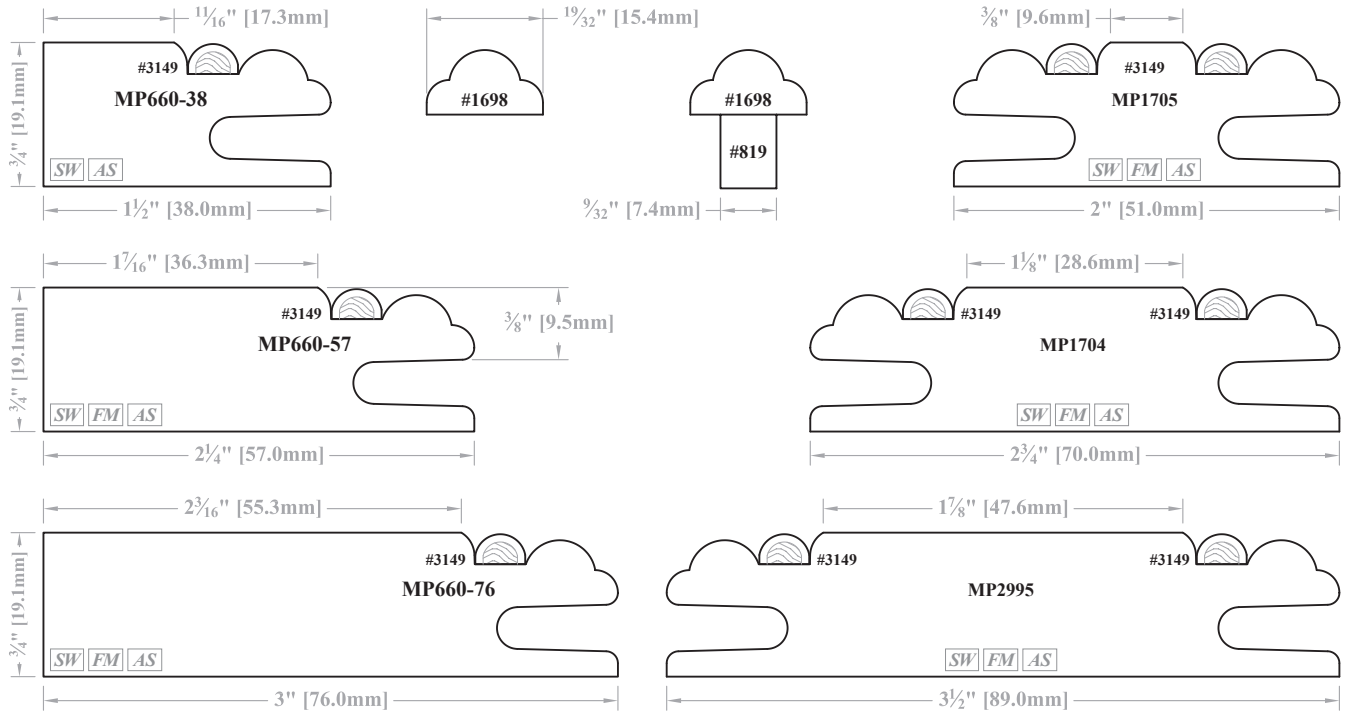

MP661 Family

Center Stiles & Rails will look like these profiles.

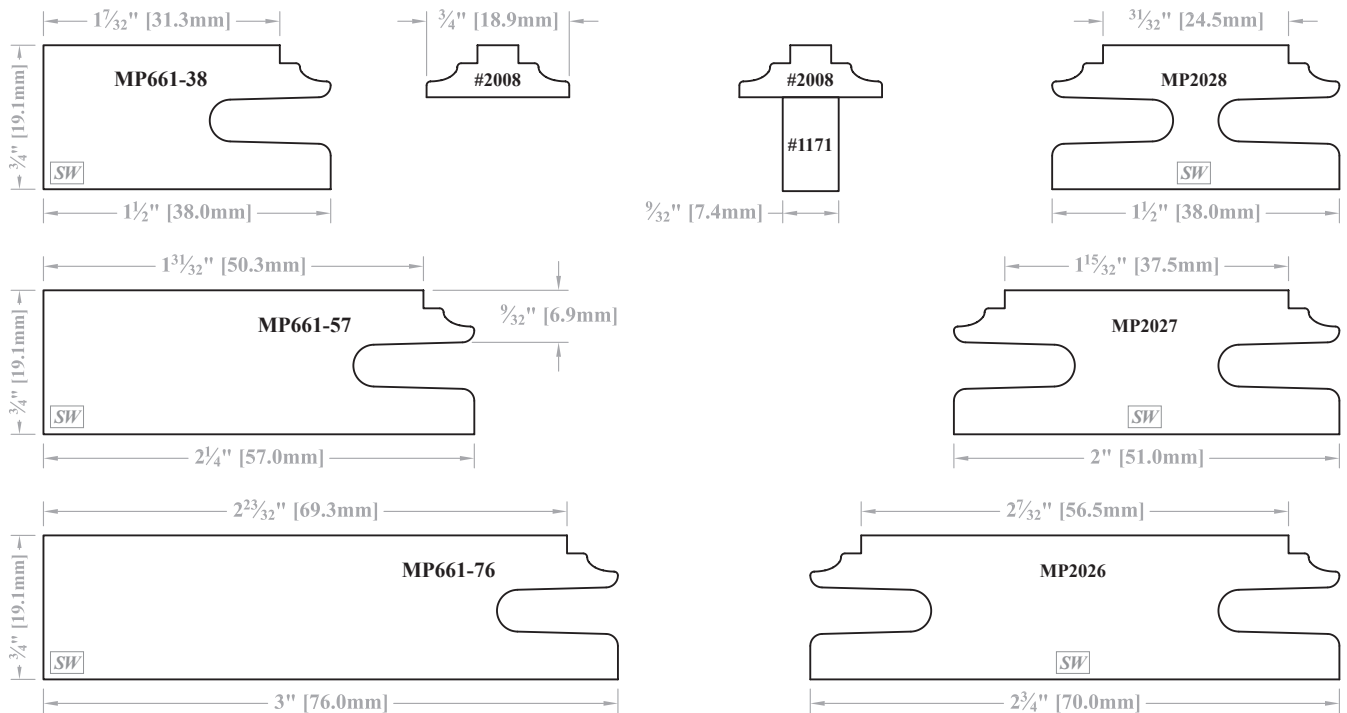

SW = Available in Solid Wood.

FM = Available for French Miter Doors.

C = Available for Convex/Concave products.

AS = Available on Adventure Series Doors.

► For PRICING ► See Section E.9 in our current Wholesale Pricing Catalog.

Mitered Stile & Rail Profiles with Matching Mullion Stock

MP662 Family

Center Stiles & Rails will look like these profiles.

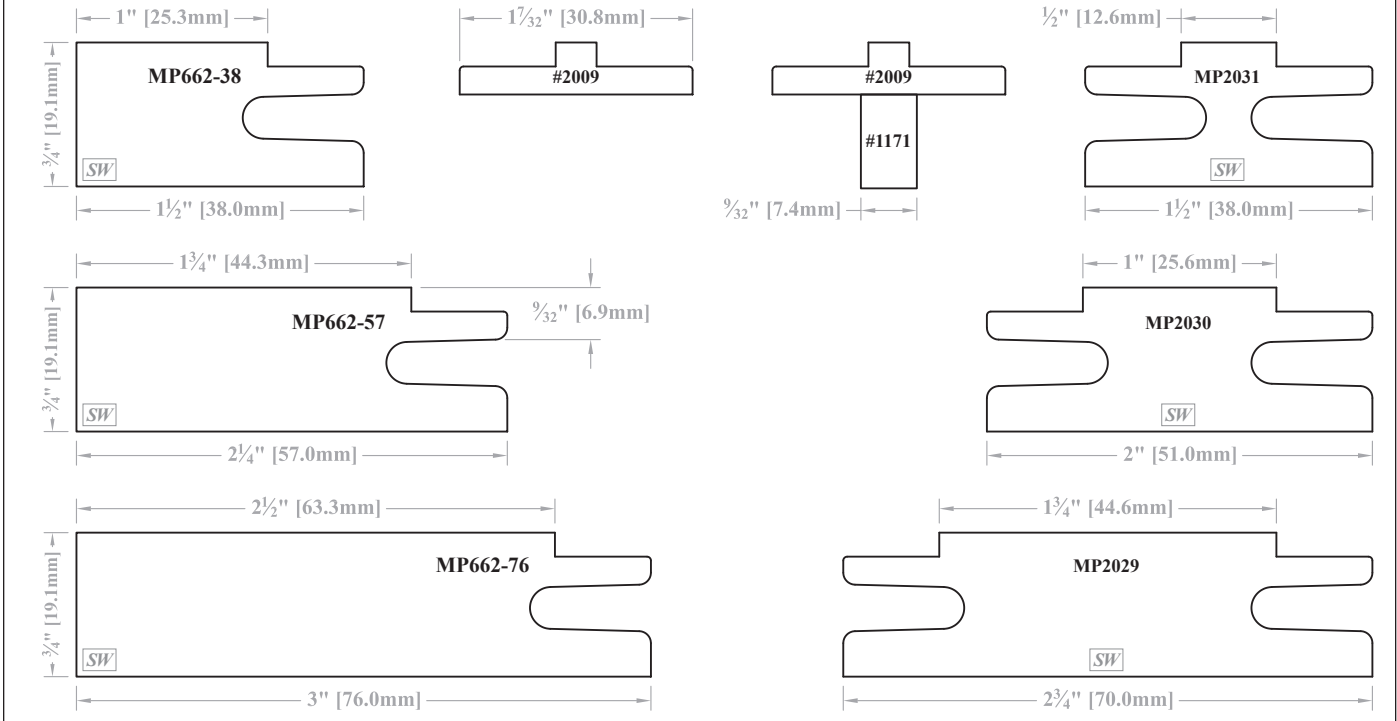

MP663 Family

Center Stiles & Rails will look like these profiles.

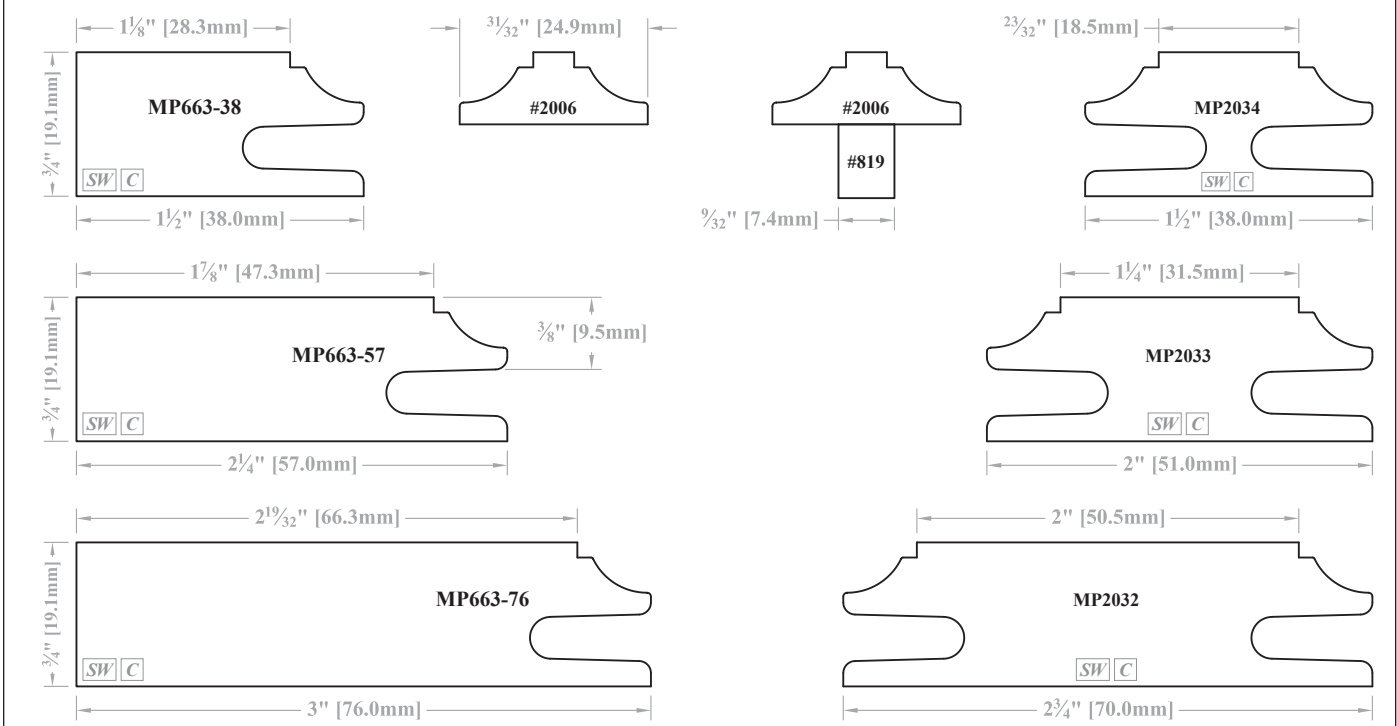

SW = Available in Solid Wood.

FM = Available for French Miter Doors.

C = Available for Convex/Concave products.

AS = Available on Adventure Series Doors.

► For PRICING ► See Section E.9 in our current Wholesale Pricing Catalog.

Profile Options

Stile & Rail - "Mitered" Mortise & Tenon Joinery - MP600/MP6000 Series

Mitered Stile & Rail Profiles with Matching Mullion Stock

MP665 Family

Center Stiles & Rails will look like these profiles.

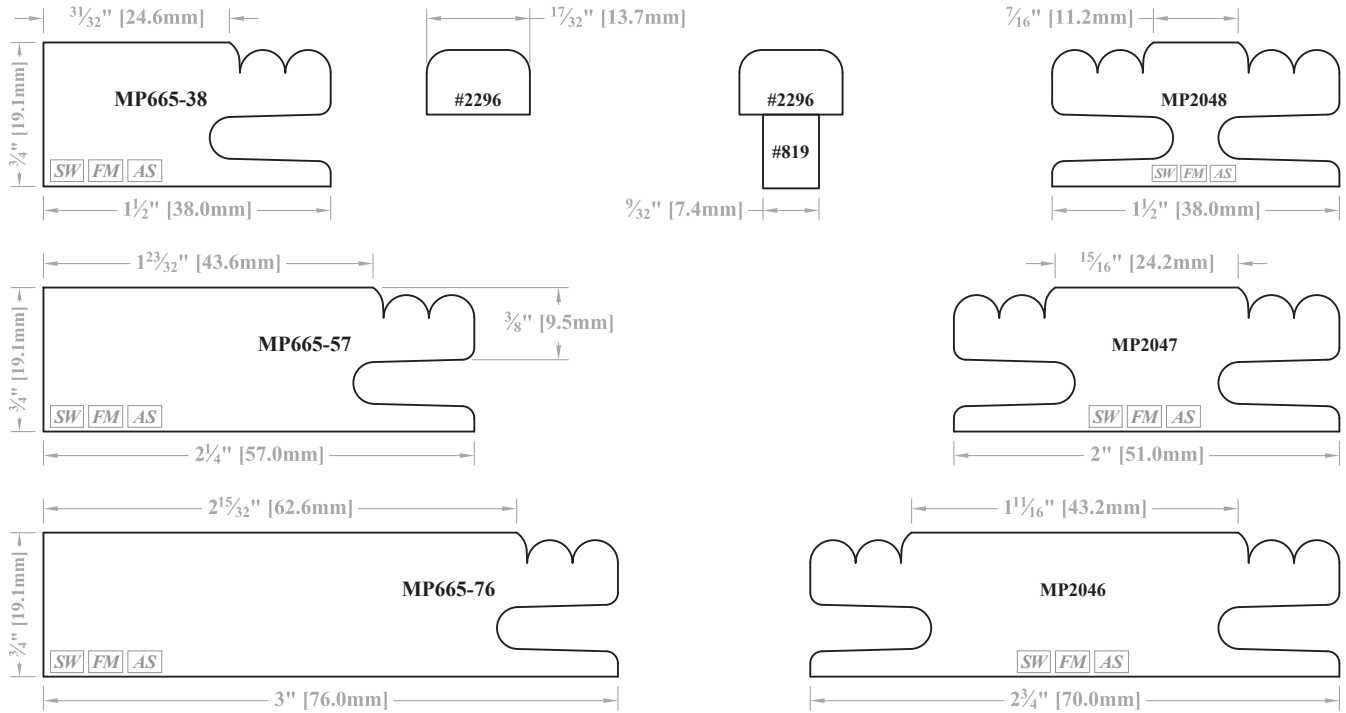

MP666 Family

Center Stiles & Rails will look like these profiles.

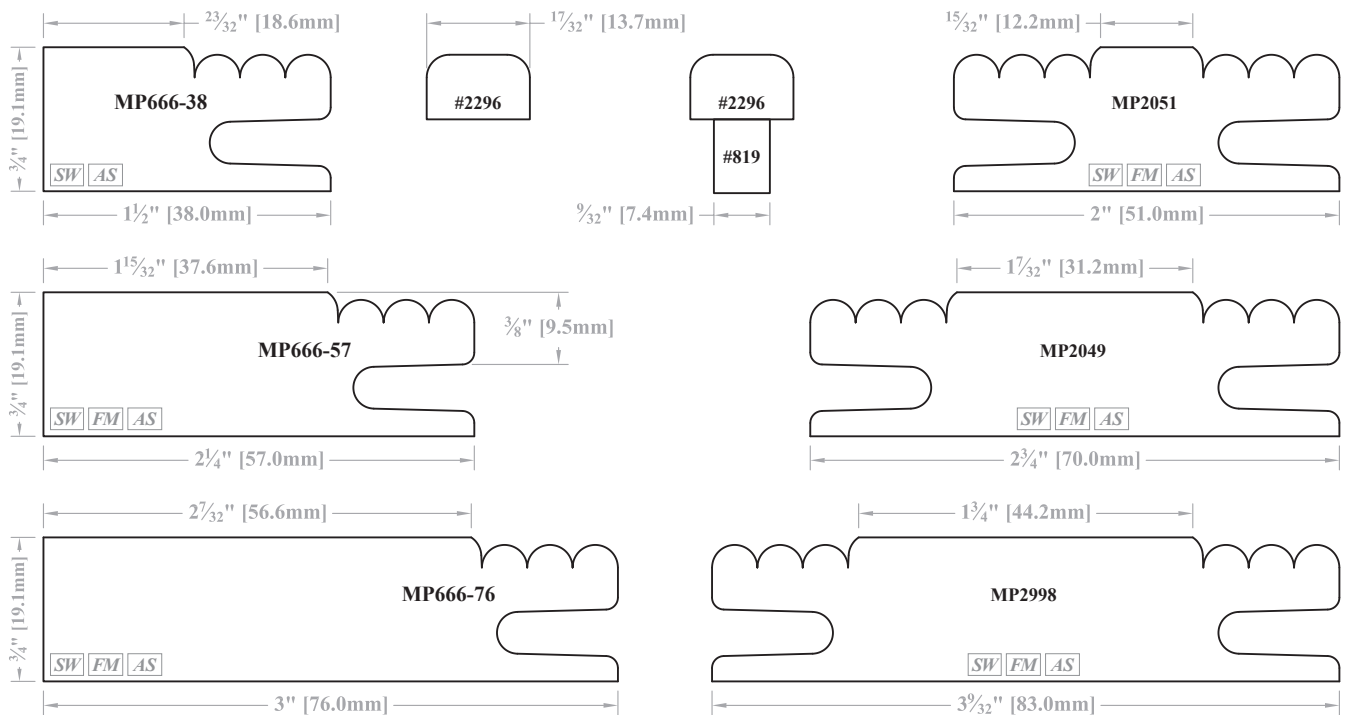

SW = Available in Solid Wood.

FM = Available for French Miter Doors.

C = Available for Convex/Concave products.

AS = Available on Adventure Series Doors.

► For PRICING ► See Section [E.9](#) in our current Wholesale Pricing Catalog.

Mitered Stile & Rail Profiles with Matching Mullion Stock

MP668 Family

See Profile Options notes in Section B.12 for alternative mullion.

Center Stiles & Rails will look like these profiles.

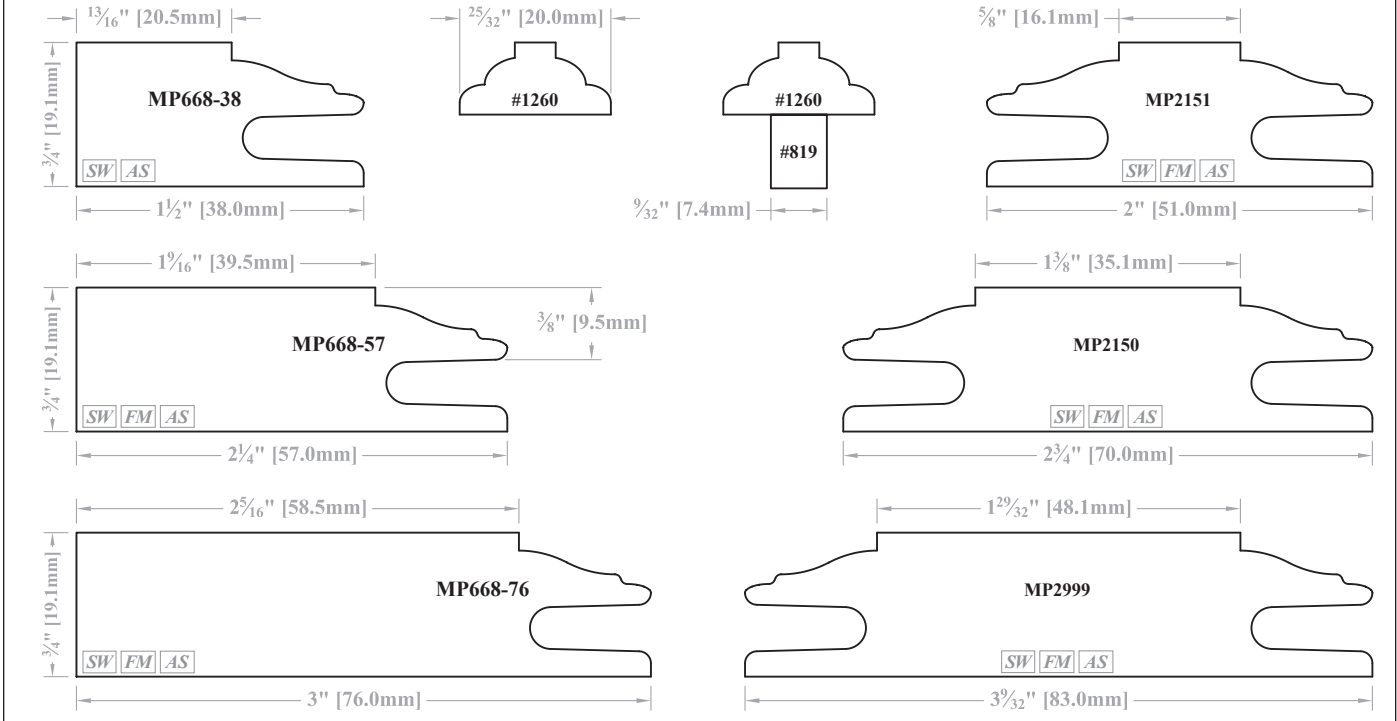

MP669 Family

Use MP646-38 for 1 1/2" [38.0mm] wide profile option as shown below.

Center Stiles & Rails will look like these profiles.

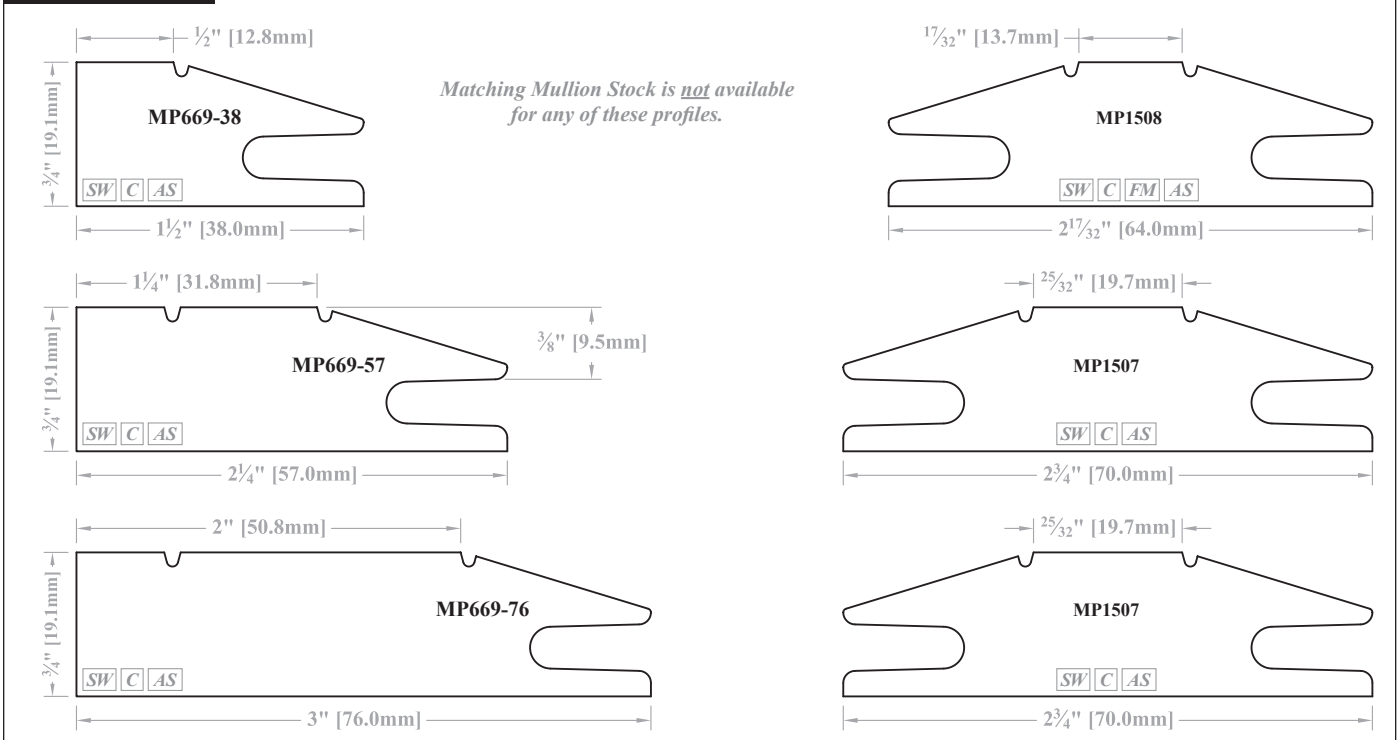

SW = Available in Solid Wood.

FM = Available for French Miter Doors.

C = Available for Convex/Concave products.

AS = Available on Adventure Series Doors.

► For PRICING ► See Section E.9 in our current Wholesale Pricing Catalog.

Profile Options

Stile & Rail - "Mitered" Mortise & Tenon Joinery - MP600/MP6000 Series

Mitered Stile & Rail Profiles with Matching Mullion Stock

MP670 Family

Center Stiles & Rails will look like these profiles.

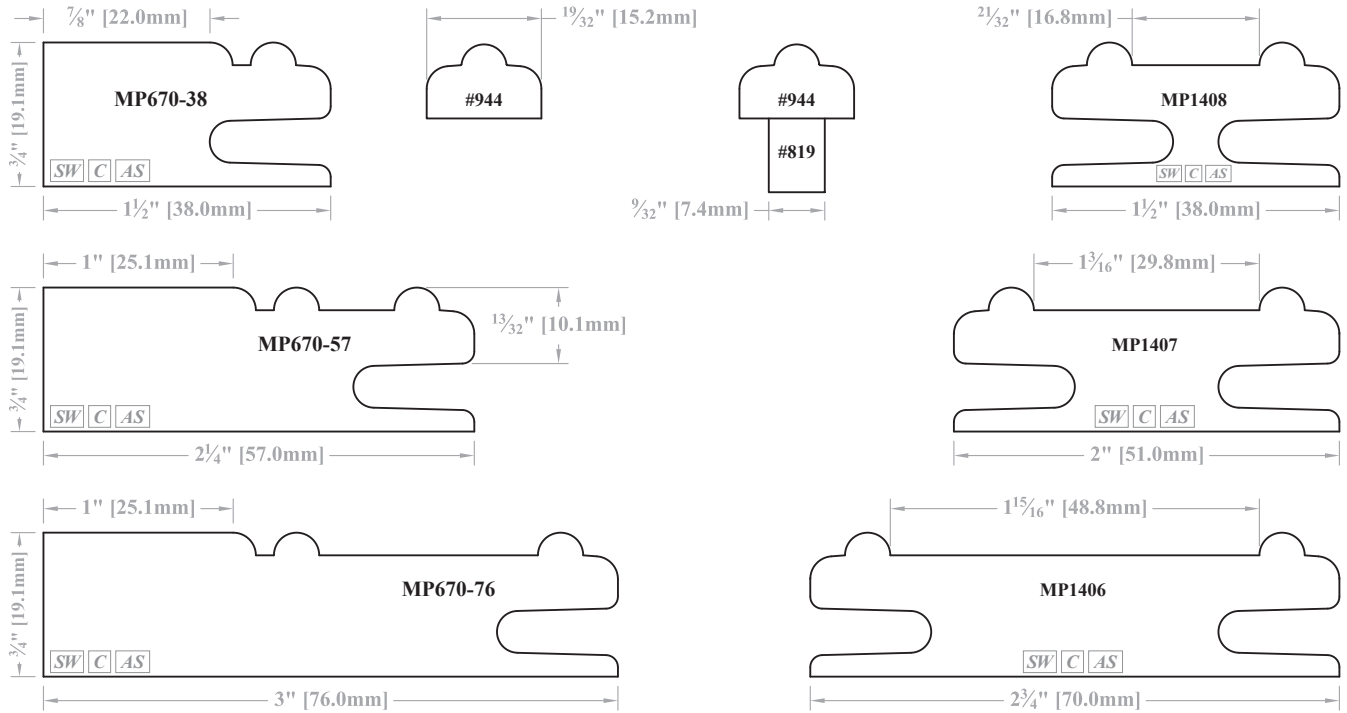

MP671 Family

Center Stiles & Rails will look like these profiles.

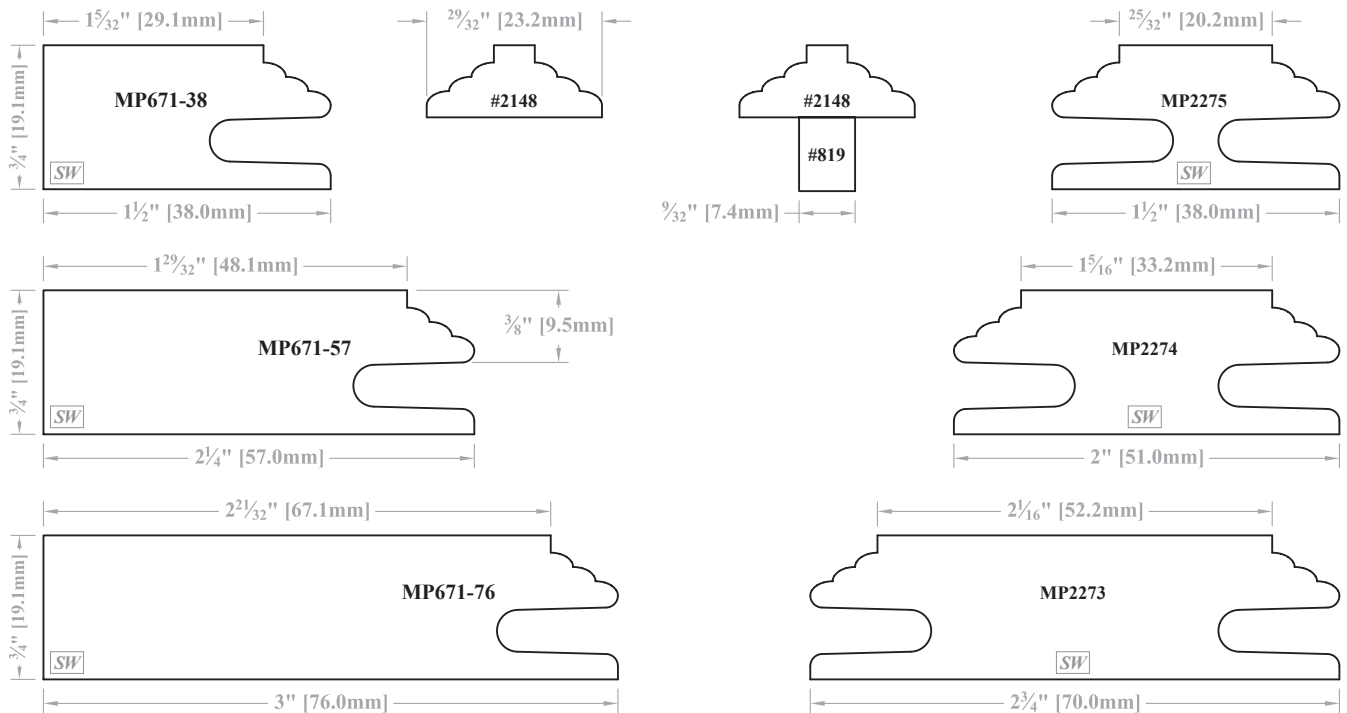

SW = Available in Solid Wood.

FM = Available for French Miter Doors.

C = Available for Convex/Concave products.

AS = Available on Adventure Series Doors.

► For PRICING ► See Section E.9 in our current Wholesale Pricing Catalog.

Mitered Stile & Rail Profiles with Matching Mullion Stock

MP672 Family

Center Stiles & Rails will look like these profiles.

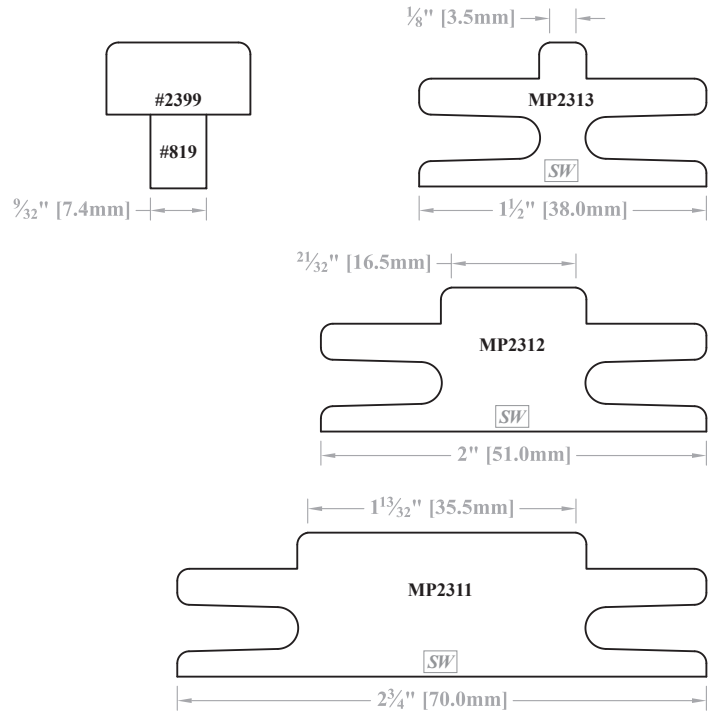
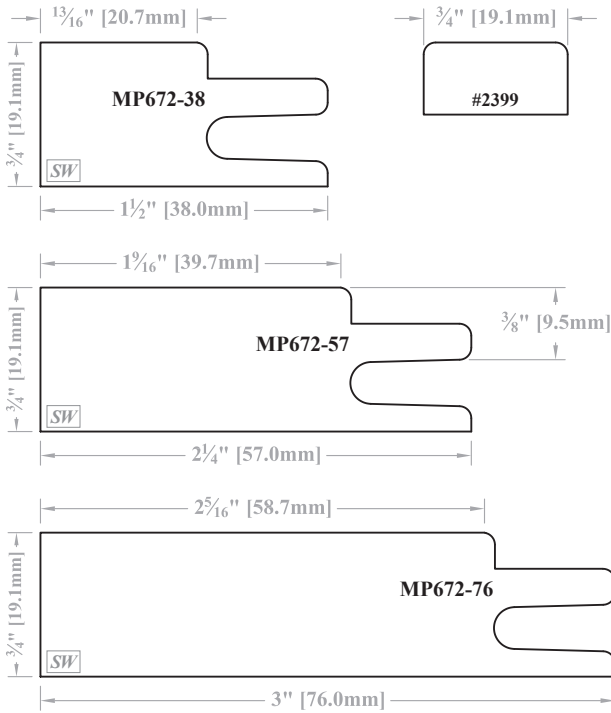

E

SW = Available in Solid Wood.

FM = Available for French Miter Doors.

C = Available for Convex/Concave products.

AS = Available on Adventure Series Doors.

► For PRICING ► See Section [E.9](#) in our current Wholesale Pricing Catalog.

Profile Options

Stile & Rail - "Mitered" Mortise & Tenon Joinery - MP600/MP6000 Series

Mitered Stile & Rail Profiles with Matching Mullion Stock

MP673 Family

Center Stiles & Rails will look like these profiles.

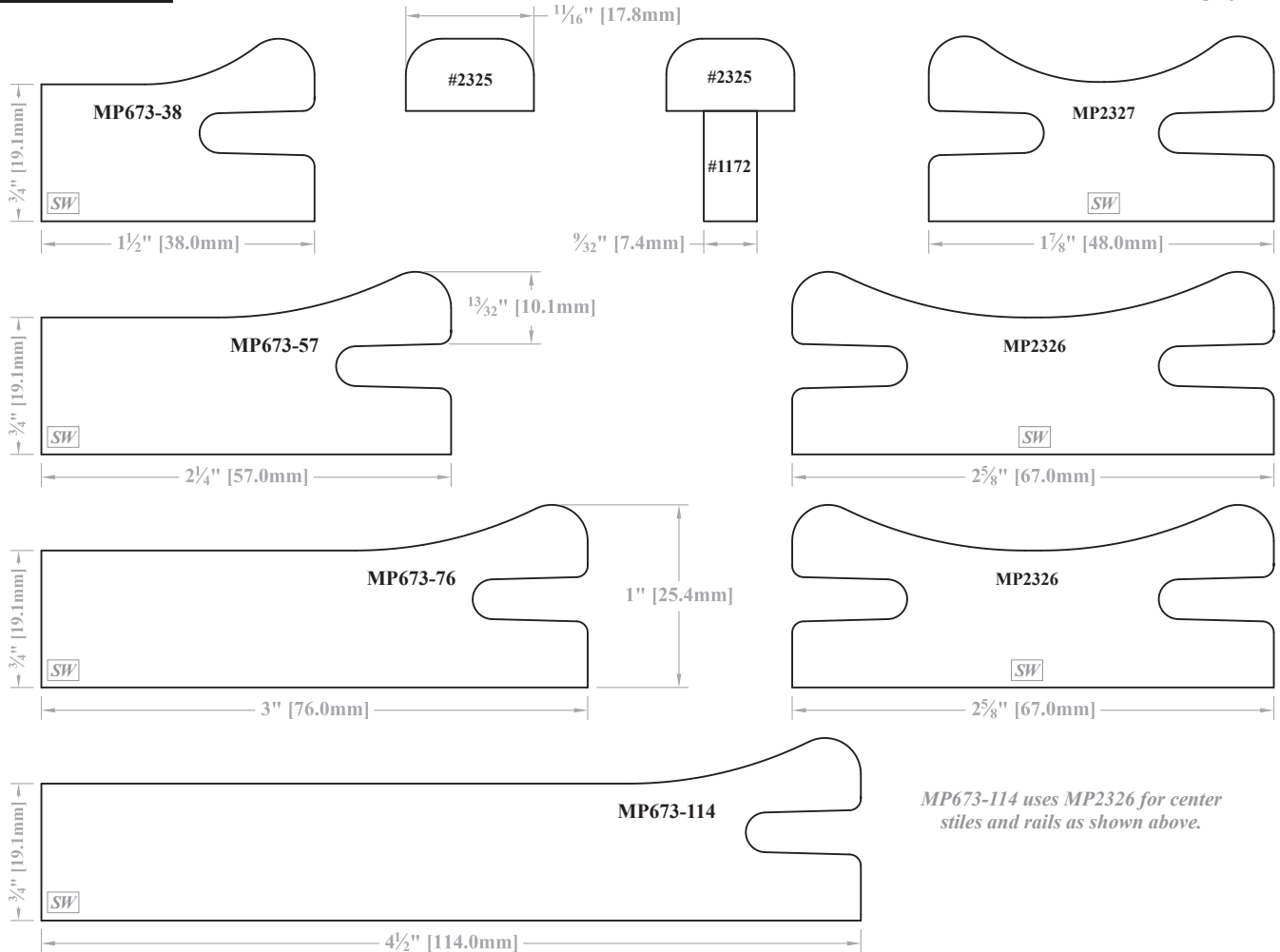

MP673-114 uses MP2326 for center stiles and rails as shown above.

Not compatible with ME outside edge profiles.
Must be ordered at 1" [25.4mm] thick. Add 30% for 1" [25.4mm] thickness.

SW = Available in Solid Wood.

FM = Available for French Miter Doors.

C = Available for Convex/Concave products.

AS = Available on Adventure Series Doors.

► For PRICING ► See Section [E.9](#) in our current Wholesale Pricing Catalog.

E.9.39
V19.1



WalzCraft.com



(Phone) 1-800-237-1326 6:00AM - 5:30PM CST (24 Hour Fax) 1-608-781-3667

Mitered Stile & Rail Profiles with Matching Mullion Stock

MP674 Family

Center Stiles & Rails will look like these profiles.

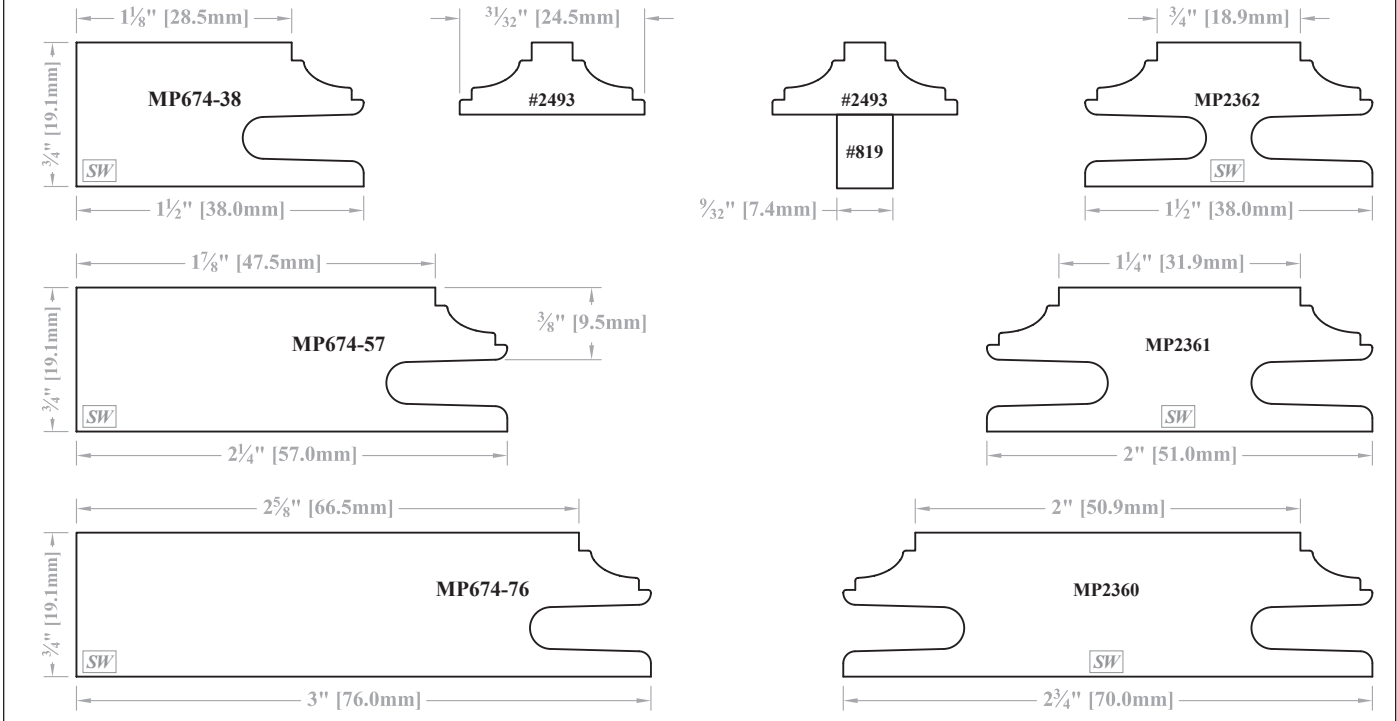

MP675 Family

See Profile Options notes in Section B.12 for alternative mullion.

Center Stiles & Rails will look like these profiles.

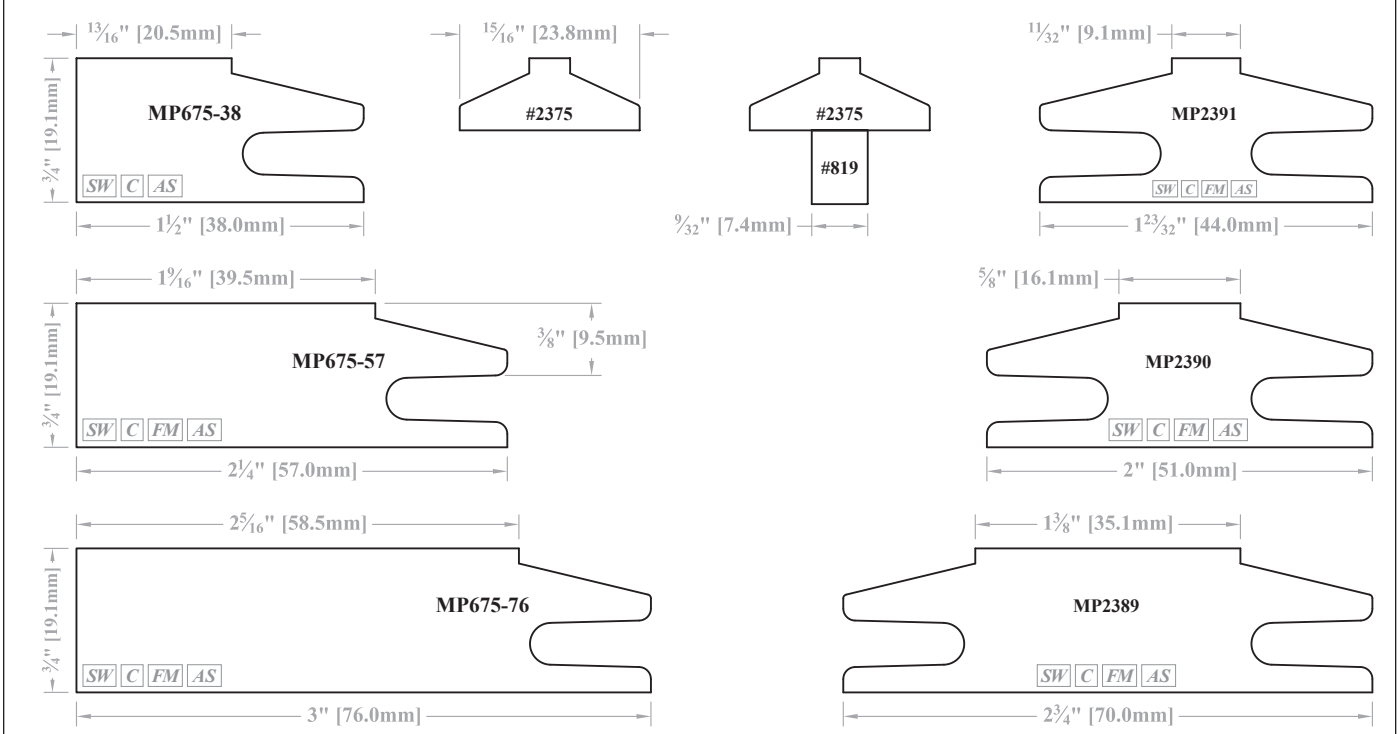

[SW] = Available in Solid Wood.

[FM] = Available for French Miter Doors.

[C] = Available for Convex/Concave products.

[AS] = Available on Adventure Series Doors.

► For PRICING ► See Section E.9 in our current Wholesale Pricing Catalog.

Profile Options

Stile & Rail - "Mitered" Mortise & Tenon Joinery - MP600/MP6000 Series

Mitered Stile & Rail Profiles with Matching Mullion Stock

MP676 Family

Center Stiles & Rails will look like these profiles.

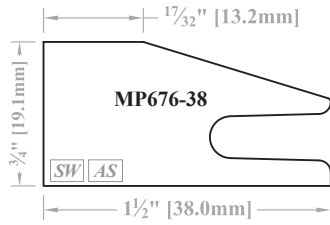

Matching Mullion Stock is not available for any of these profiles.

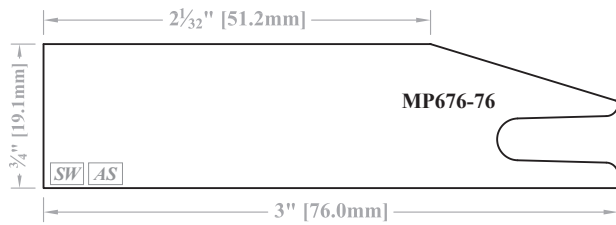
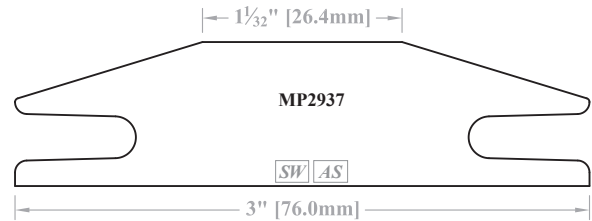
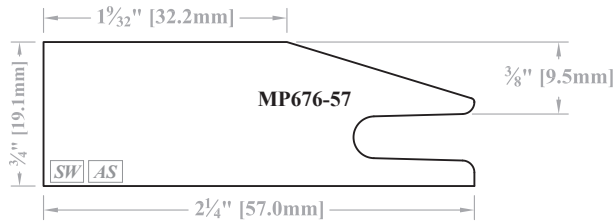
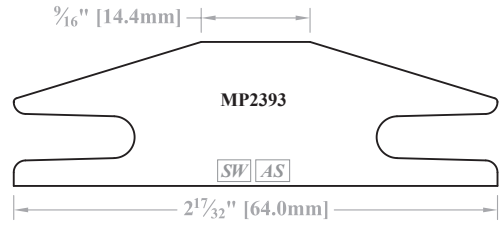

MP676-76 uses MP3083 for center stiles & rails as shown below.

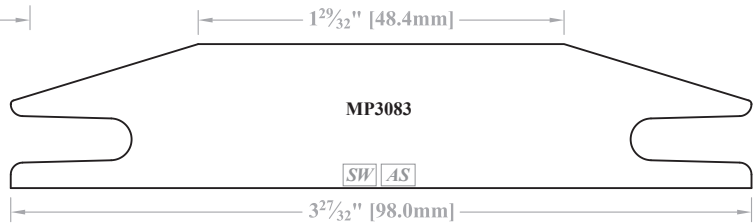

SW = Available in Solid Wood.

FM = Available for French Miter Doors.

C = Available for Convex/Concave products.

AS = Available on Adventure Series Doors.

► For PRICING ► See Section [E.9](#) in our current Wholesale Pricing Catalog.

E.9.41

V19.1



WalzCraft®



(Phone) 1-800-237-1326 6:00AM - 5:30PM CST (24 Hour Fax) 1-608-781-3667

Mitered Stile & Rail Profiles with Matching Mullion Stock

MP677 Family

(X) = Applied Molding Shelf, molding is optional

Center Stiles & Rails will look like these profiles.

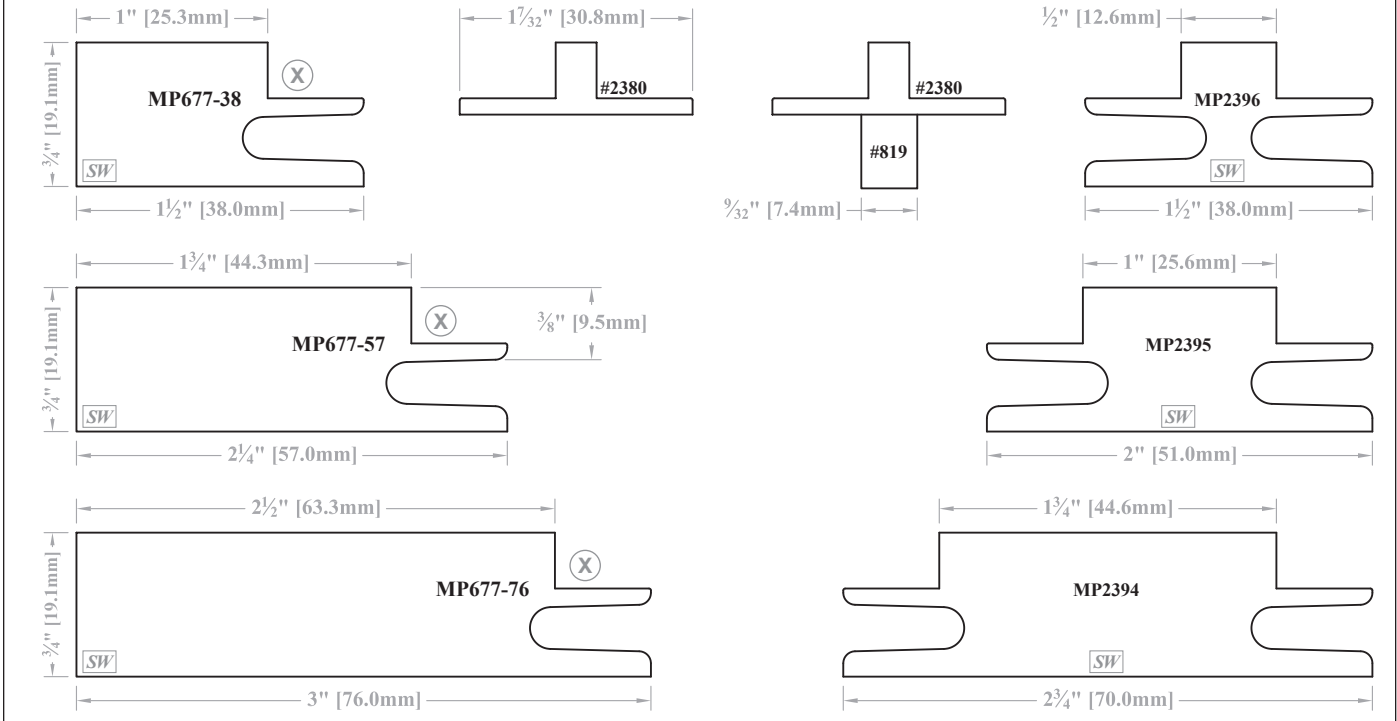

MP678 Family

Center Stiles & Rails will look like these profiles.

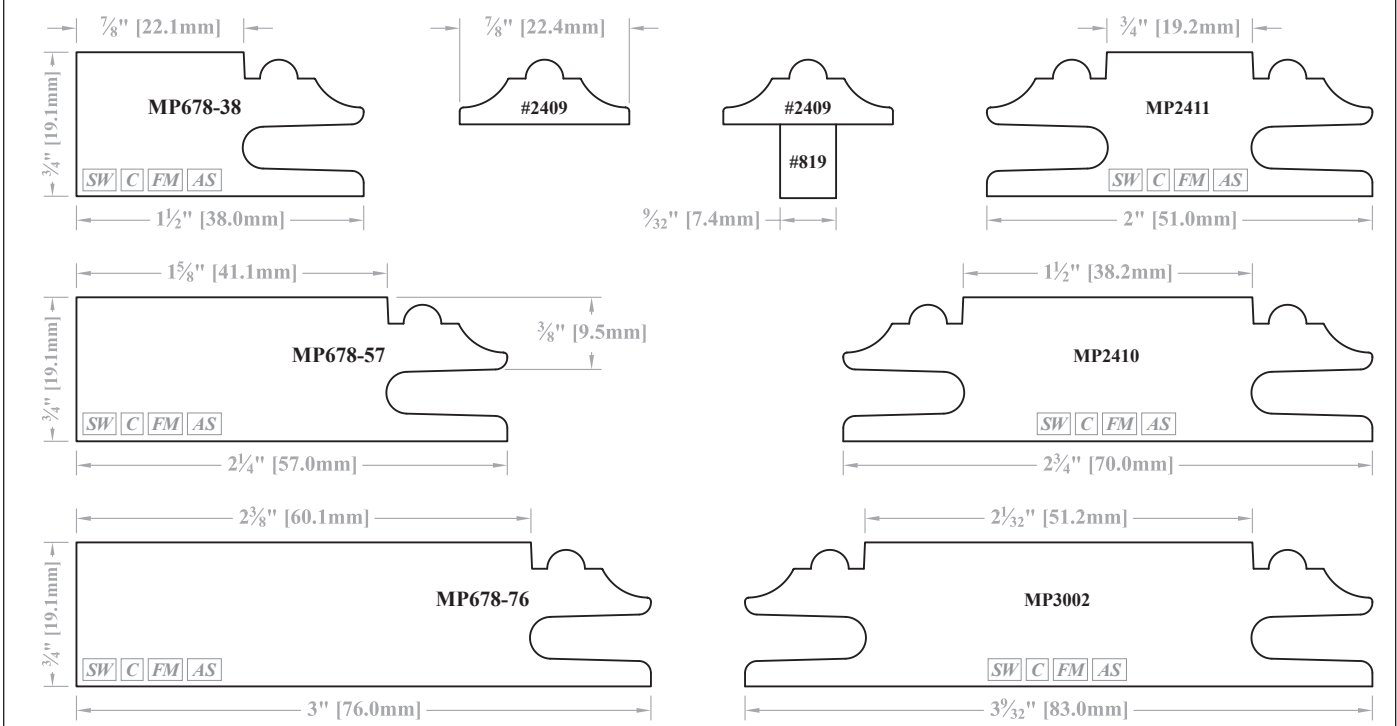

SW = Available in Solid Wood. FM = Available for French Miter Doors. C = Available for Convex/Concave products. AS = Available on Adventure Series Doors.

► For PRICING ► See Section E.9 in our current Wholesale Pricing Catalog.

Profile Options

Stile & Rail - "Mitered" Mortise & Tenon Joinery - MP600/MP6000 Series

Mitered Stile & Rail Profiles with Matching Mullion Stock

MP679 Family

Center Stiles & Rails will look like these profiles.

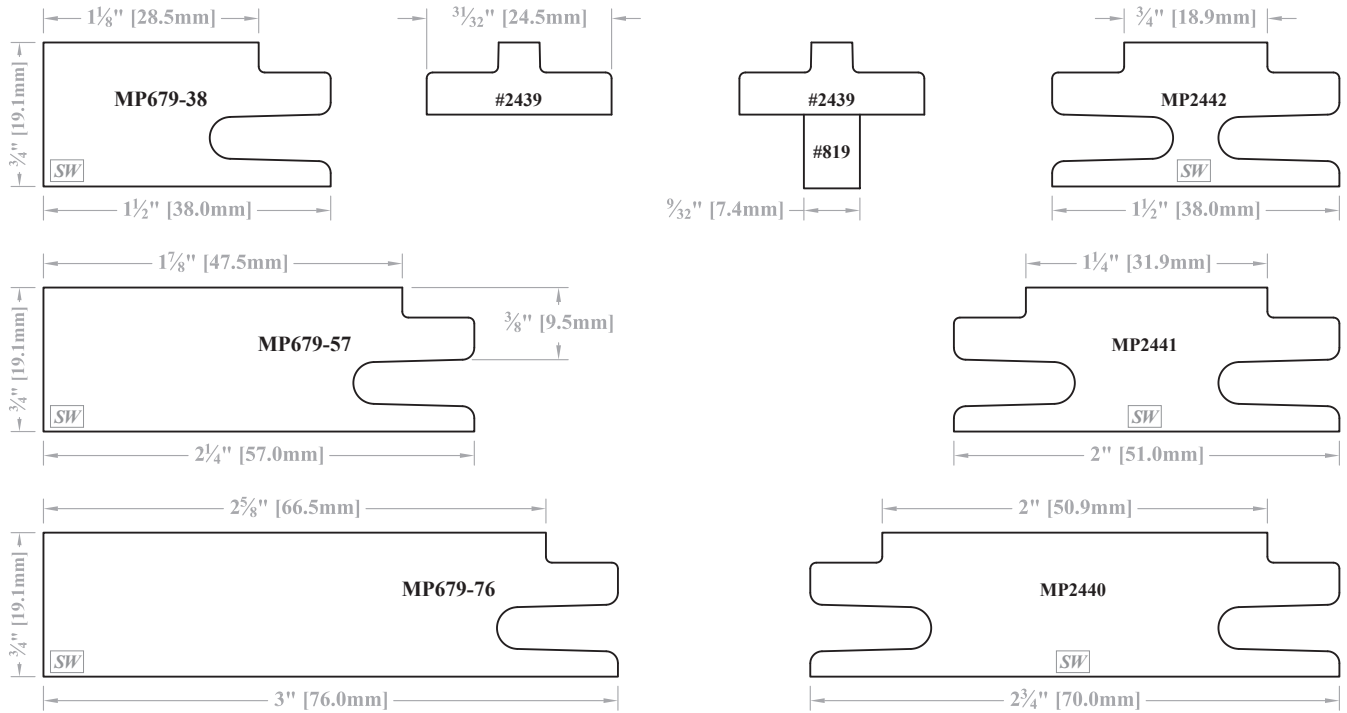

MP680 Family

Center Stiles & Rails will look like these profiles.

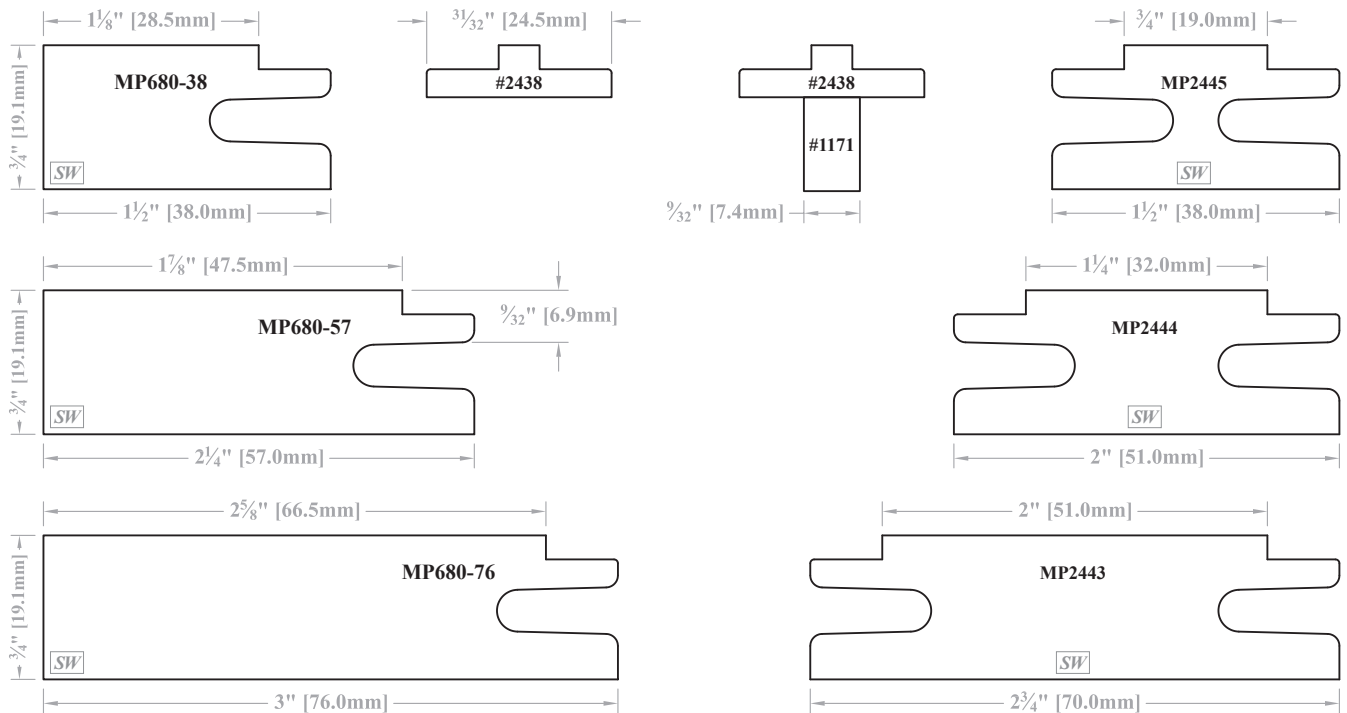

SW = Available in Solid Wood.

FM = Available for French Miter Doors.

C = Available for Convex/Concave products.

AS = Available on Adventure Series Doors.

► For PRICING ► See Section [E.9](#) in our current Wholesale Pricing Catalog.

Mitered Stile & Rail Profiles with Matching Mullion Stock

MP681 Family

Center Stiles & Rails will look like these profiles.

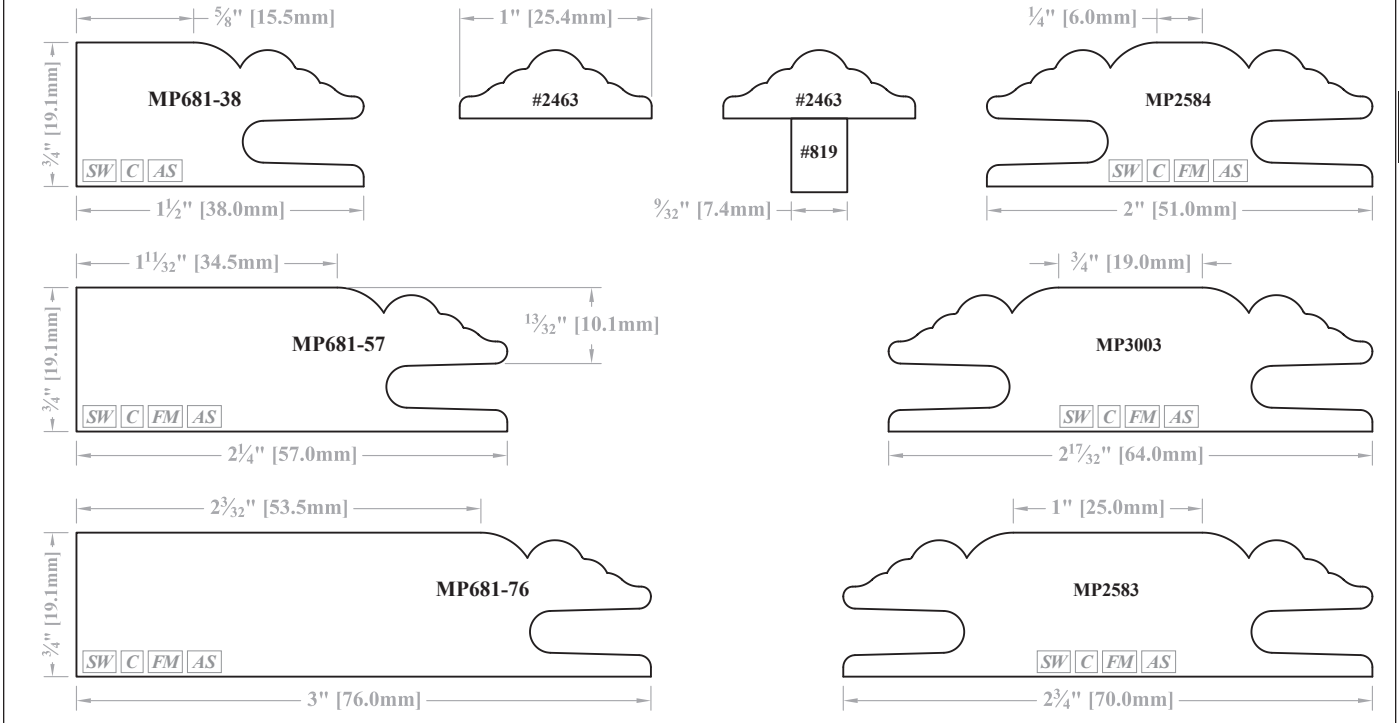

MP682 Family

Center Stiles & Rails will look like these profiles.

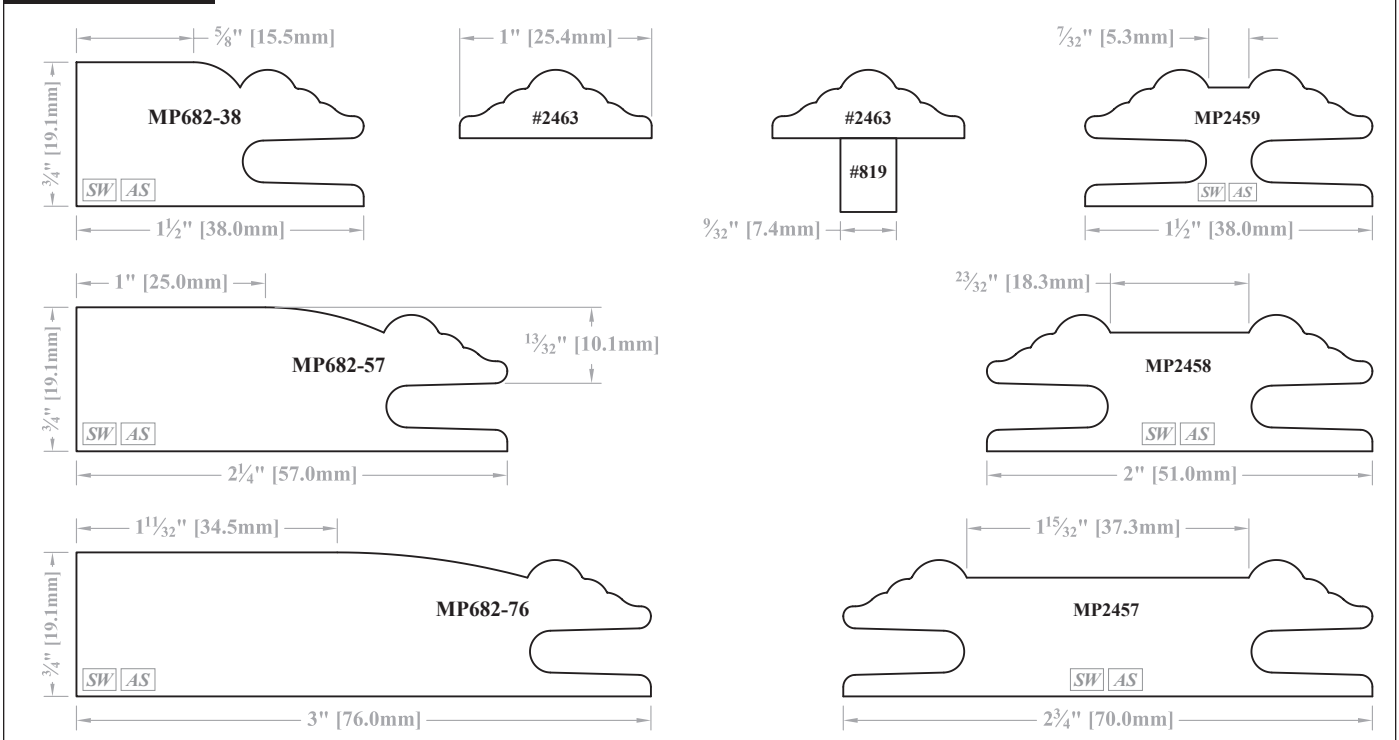

SW = Available in Solid Wood.

FM = Available for French Miter Doors.

C = Available for Convex/Concave products.

AS = Available on Adventure Series Doors.

► For PRICING ► See Section E.9 in our current Wholesale Pricing Catalog.

Profile Options

Stile & Rail - "Mitered" Mortise & Tenon Joinery - MP600/MP6000 Series

Mitered Stile & Rail Profiles with Matching Mullion Stock

MP683 Family

Center Stiles & Rails will look like these profiles.

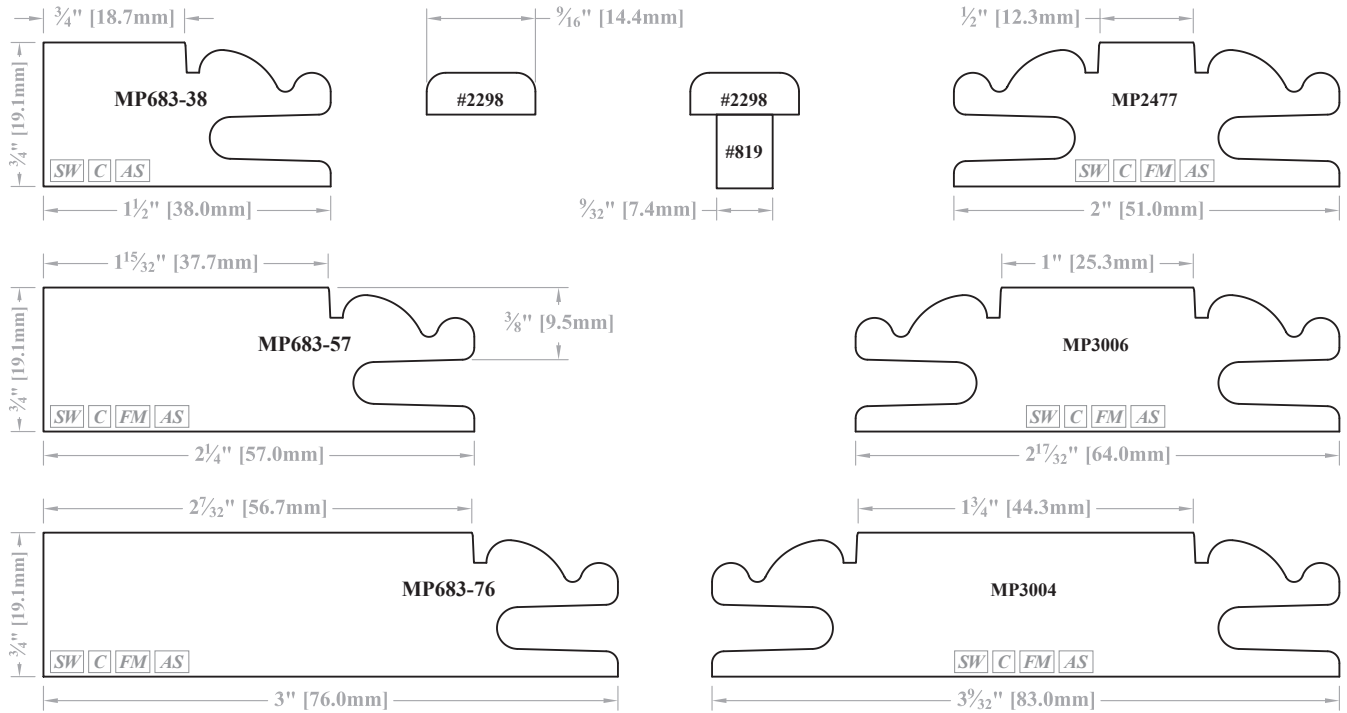

MP684 Family

Center Stiles & Rails will look like these profiles.

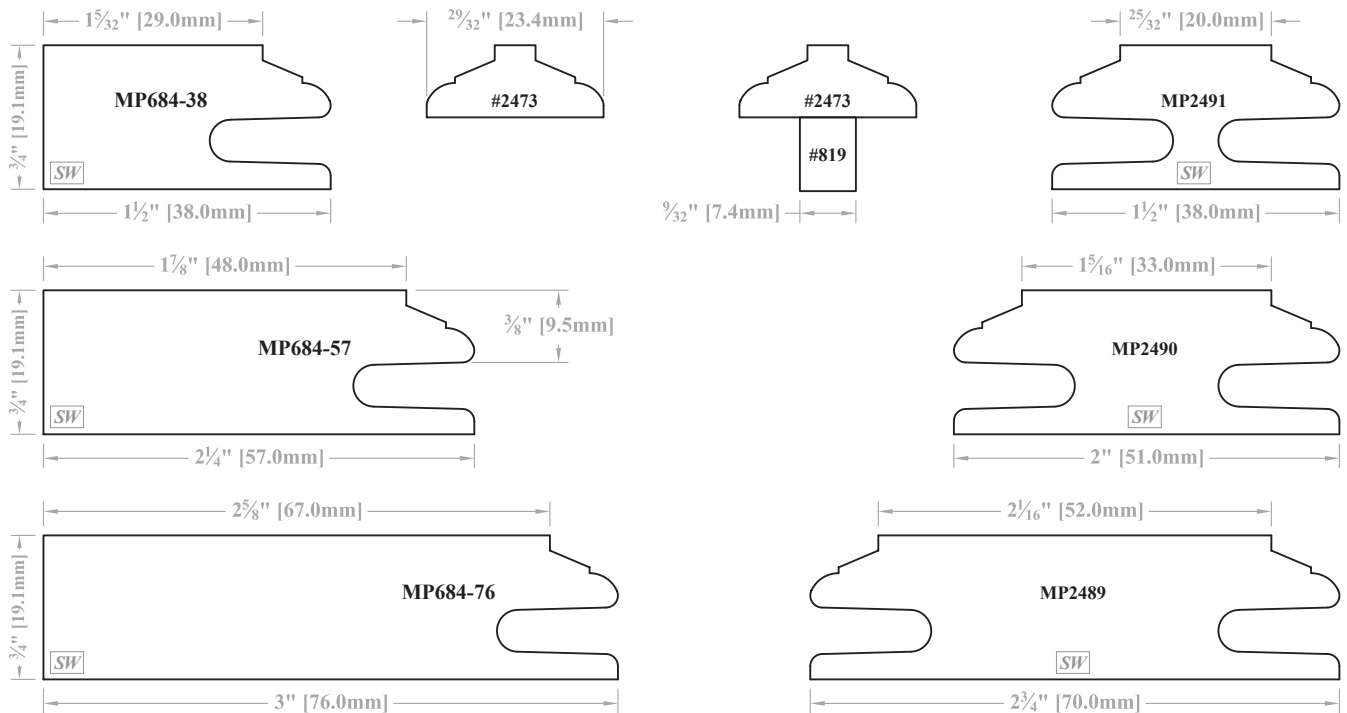

SW = Available in Solid Wood.

FM = Available for French Miter Doors.

C = Available for Convex/Concave products.

AS = Available on Adventure Series Doors.

► For PRICING ► See Section E.9 in our current Wholesale Pricing Catalog.

Mitered Stile & Rail Profiles with Matching Mullion Stock

MP685 Family

See *Profile Options* notes in Section B.12 for alternative mullion.

Center Stiles & Rails will look like these profiles.

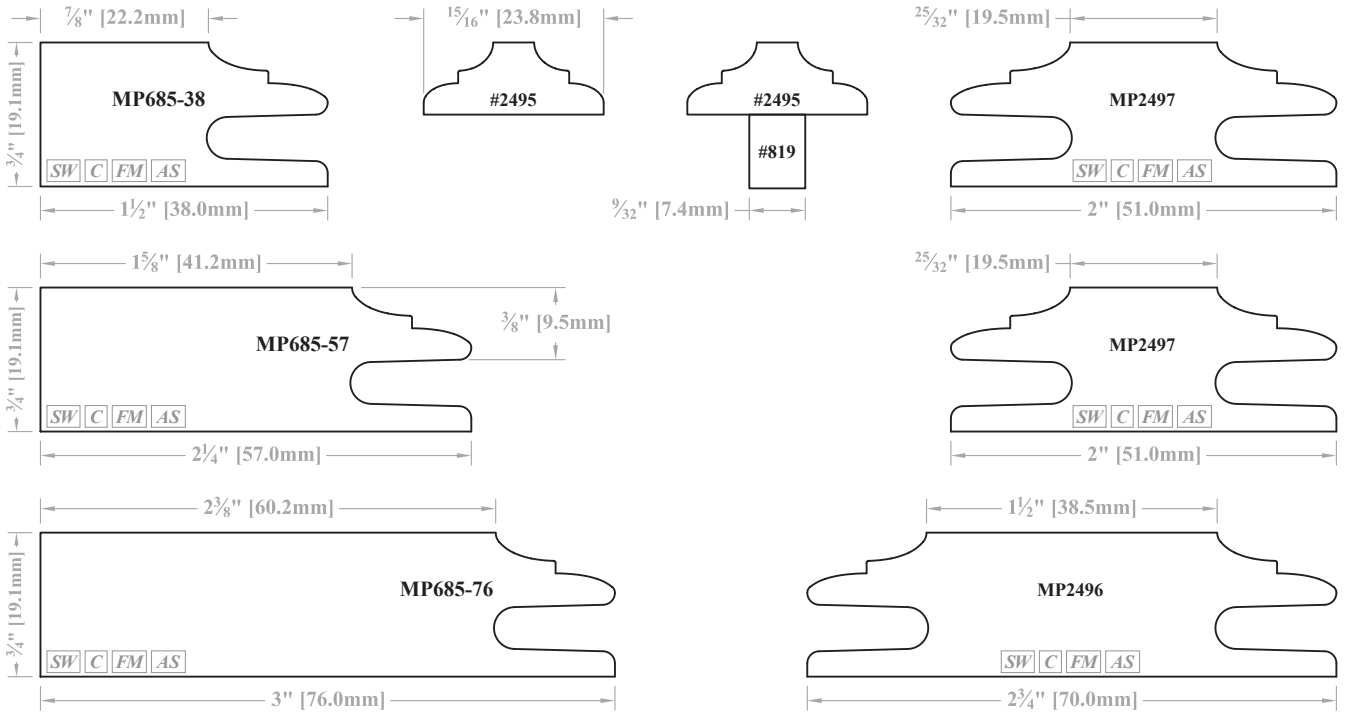

E

MP686 Family

Center Stiles & Rails will look like these profiles.

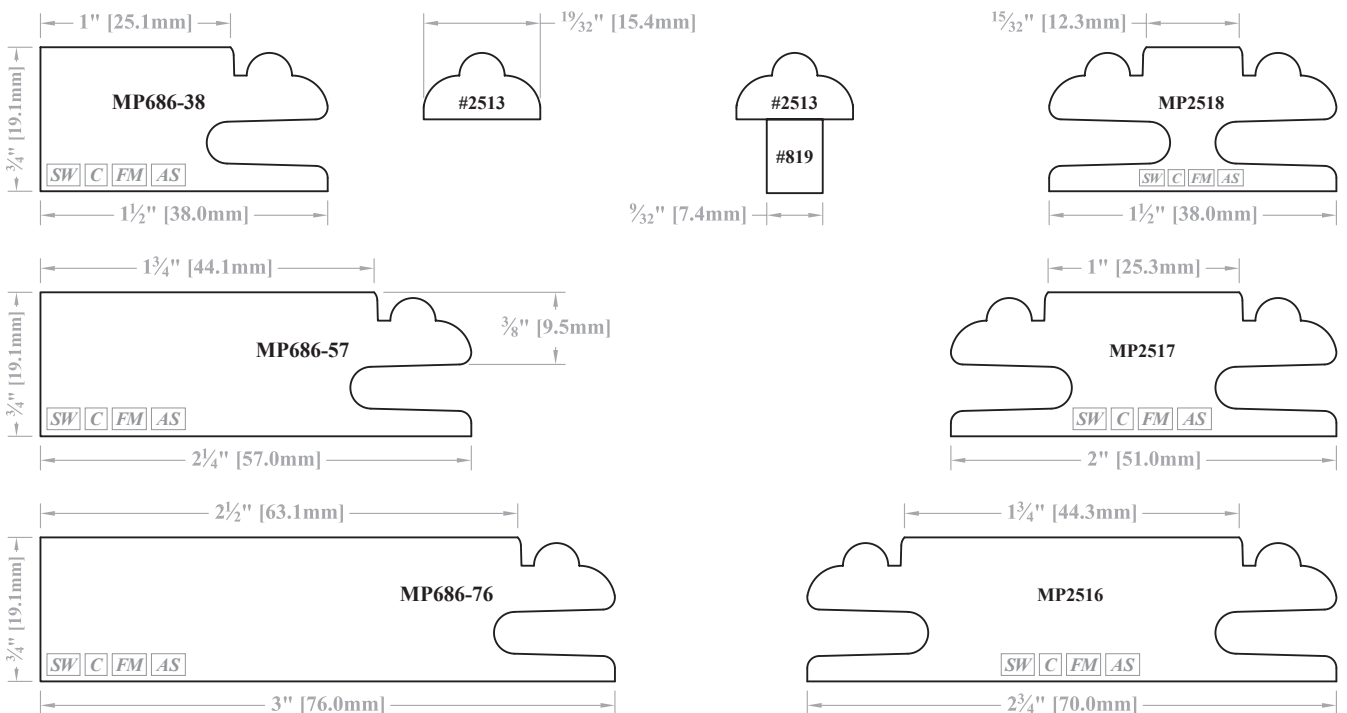

SW = Available in Solid Wood. FM = Available for French Miter Doors. C = Available for Convex/Concave products. AS = Available on Adventure Series Doors.

► For PRICING ► See Section E.9 in our current Wholesale Pricing Catalog.

Profile Options

Stile & Rail - "Mitered" Mortise & Tenon Joinery - MP600 / MP6000 Series

Mitered Stile & Rail Profiles with Matching Mullion Stock

MP687 Family

Center Stiles & Rails will look like these profiles.

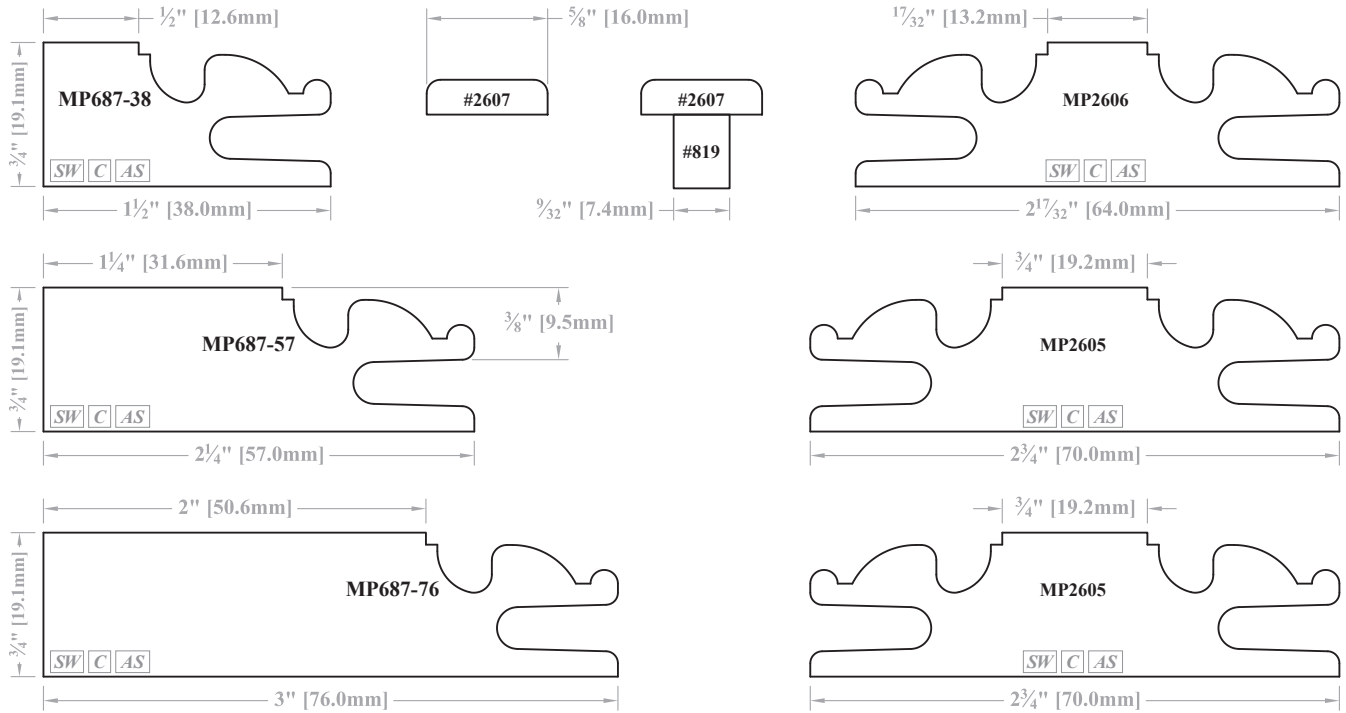

MP688 Family

Center Stiles & Rails will look like these profiles.

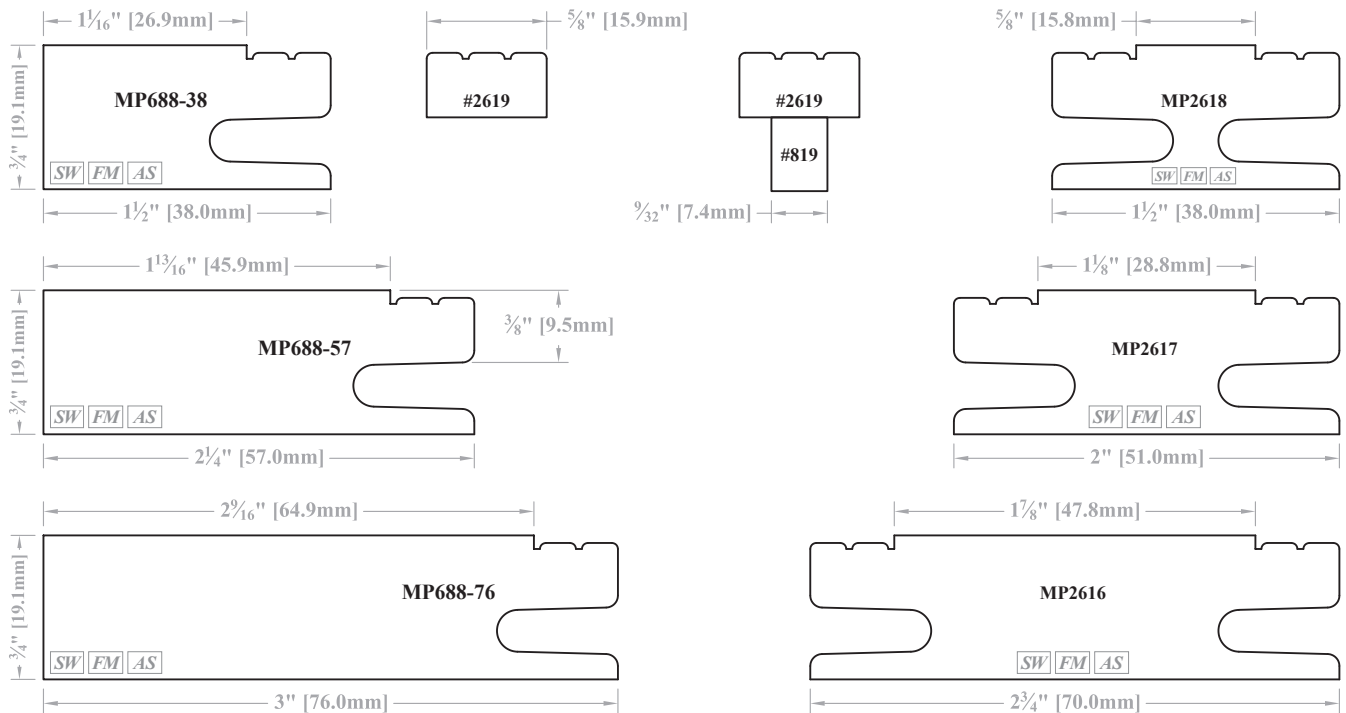

SW = Available in Solid Wood.

FM = Available for French Miter Doors.

C = Available for Convex/Concave products.

AS = Available on Adventure Series Doors.

► For PRICING ► See Section E.9 in our current Wholesale Pricing Catalog.

Mitered Stile & Rail Profiles with Matching Mullion Stock

MP689 Family

Center Stiles & Rails will look like these profiles.

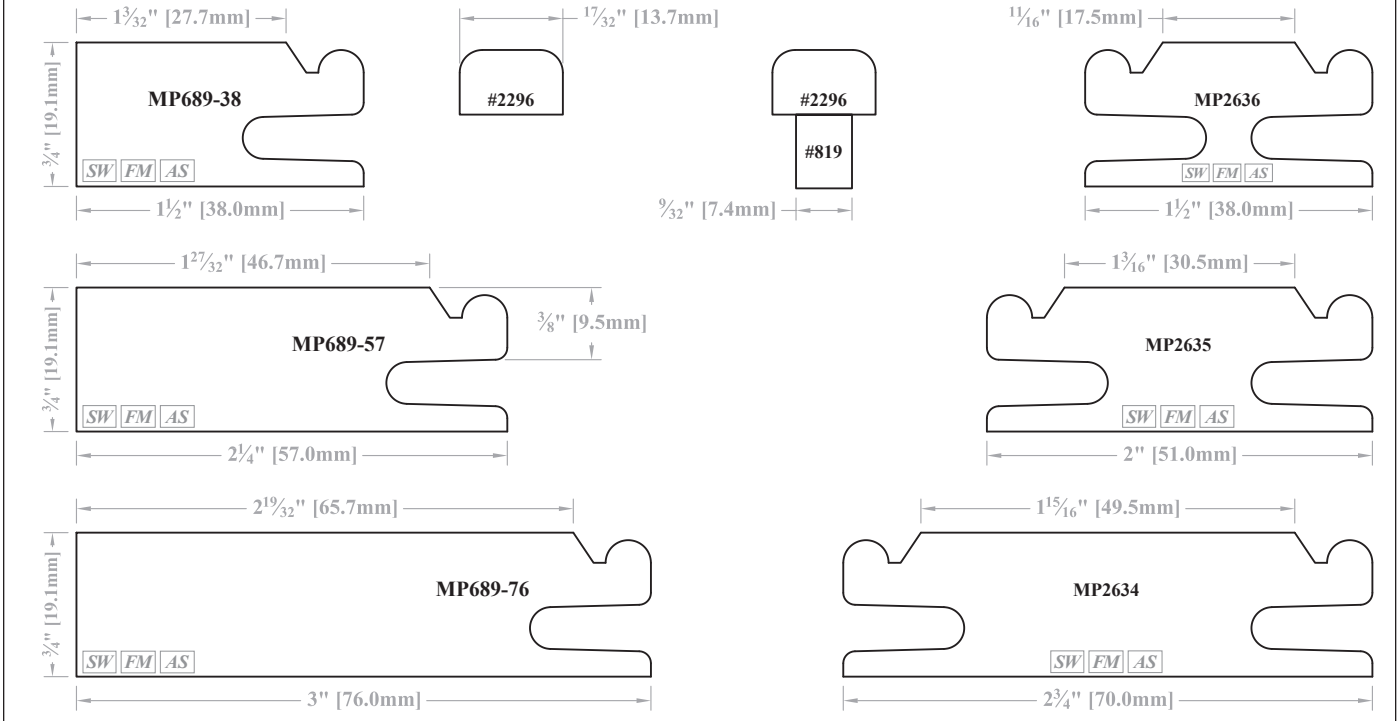

MP690 Family

Center Stiles & Rails will look like these profiles.

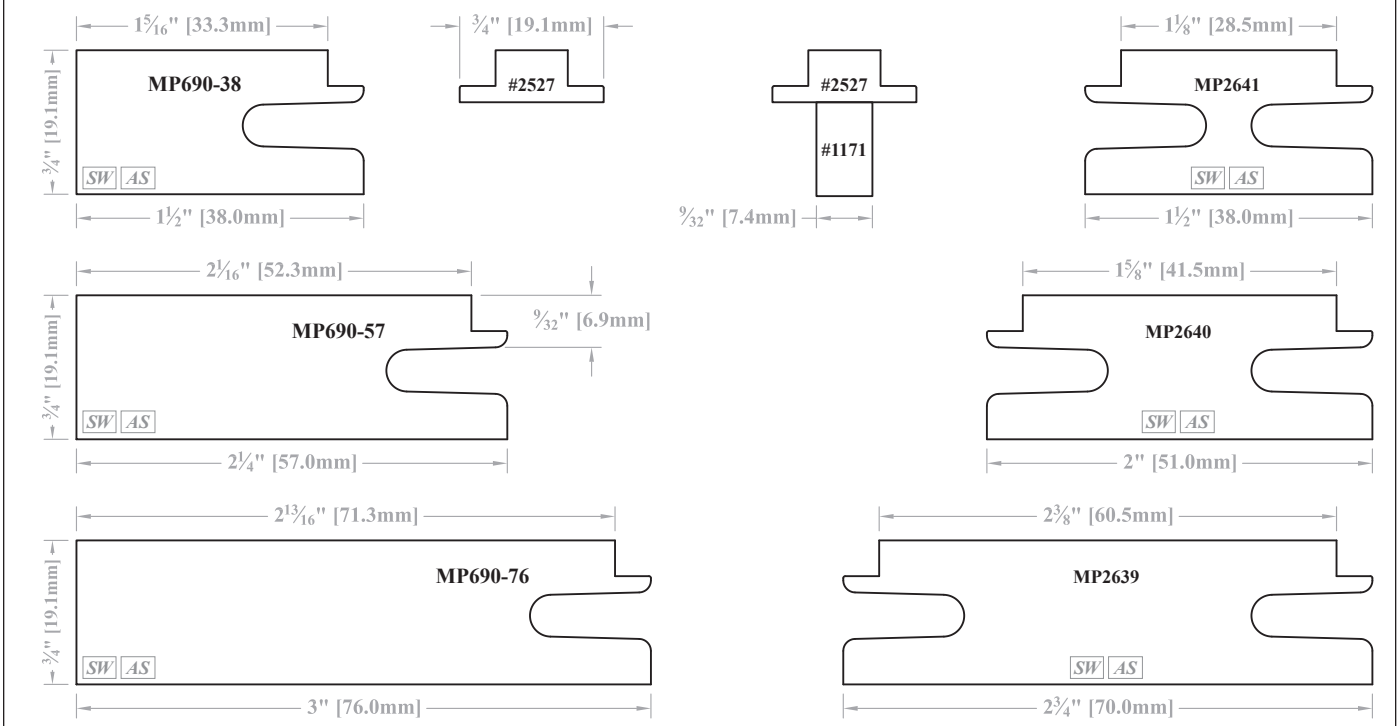

SW = Available in Solid Wood.

FM = Available for French Miter Doors.

C = Available for Convex/Concave products.

AS = Available on Adventure Series Doors.

► For PRICING ► See Section E.9 in our current Wholesale Pricing Catalog.

Mitered Stile & Rail Profiles with Matching Mullion Stock

MP691 Family

Center Stiles & Rails will look like these profiles.

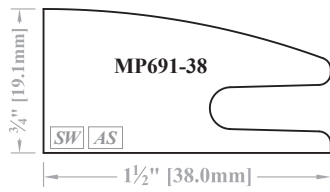

Matching Mullion Stock is not available for any of these profiles.

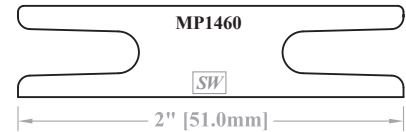
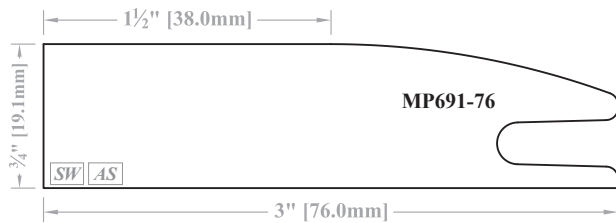
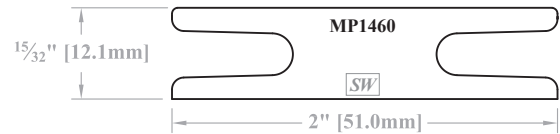
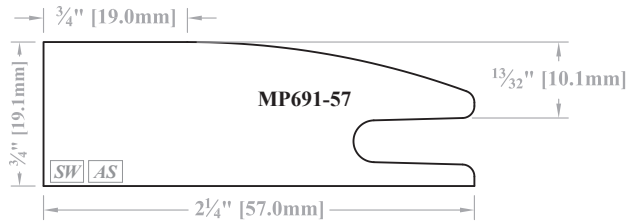
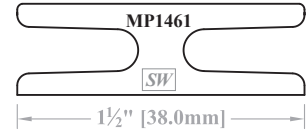

Adventure Series doors will use MP3092 for center stiles & rails as shown to the right.

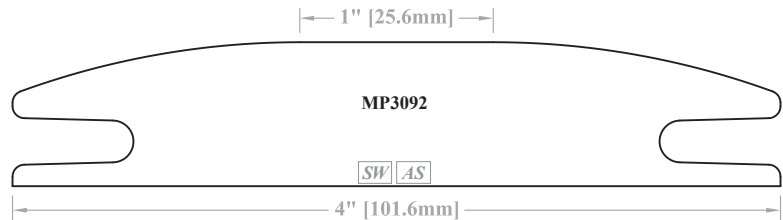

SW = Available in Solid Wood.

FM = Available for French Miter Doors.

C = Available for Convex/Concave products.

AS = Available on Adventure Series Doors.

► For PRICING ► See Section [E.9](#) in our current Wholesale Pricing Catalog.

Mitered Stile & Rail Profiles with Matching Mullion Stock

MP692 Family

Center Stiles & Rails will look like these profiles.

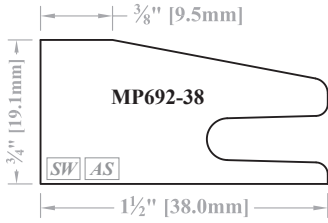

Matching Mullion Stock is not available for any of these profiles.

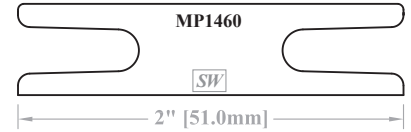
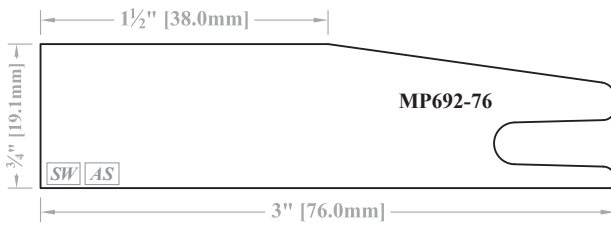
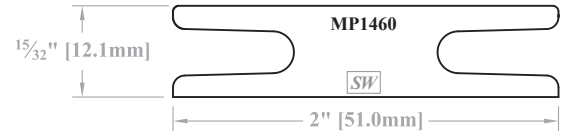
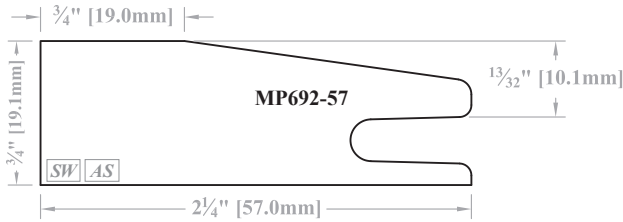
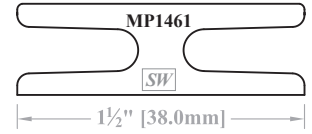

Adventure Series doors will use MP3093 for center stiles & rails as shown to the right.

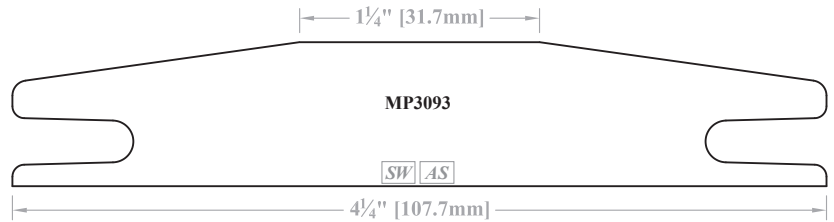

[SW] = Available in Solid Wood. [FM] = Available for French Miter Doors. [C] = Available for Convex/Concave products. [AS] = Available on Adventure Series Doors.

► For PRICING ► See Section E.9 in our current Wholesale Pricing Catalog.

E

Profile Options

Stile & Rail - "Mitered" Mortise & Tenon Joinery - MP600/MP6000 Series

Mitered Stile & Rail Profiles with Matching Mullion Stock

MP693 Family

Center Stiles & Rails will look like these profiles.

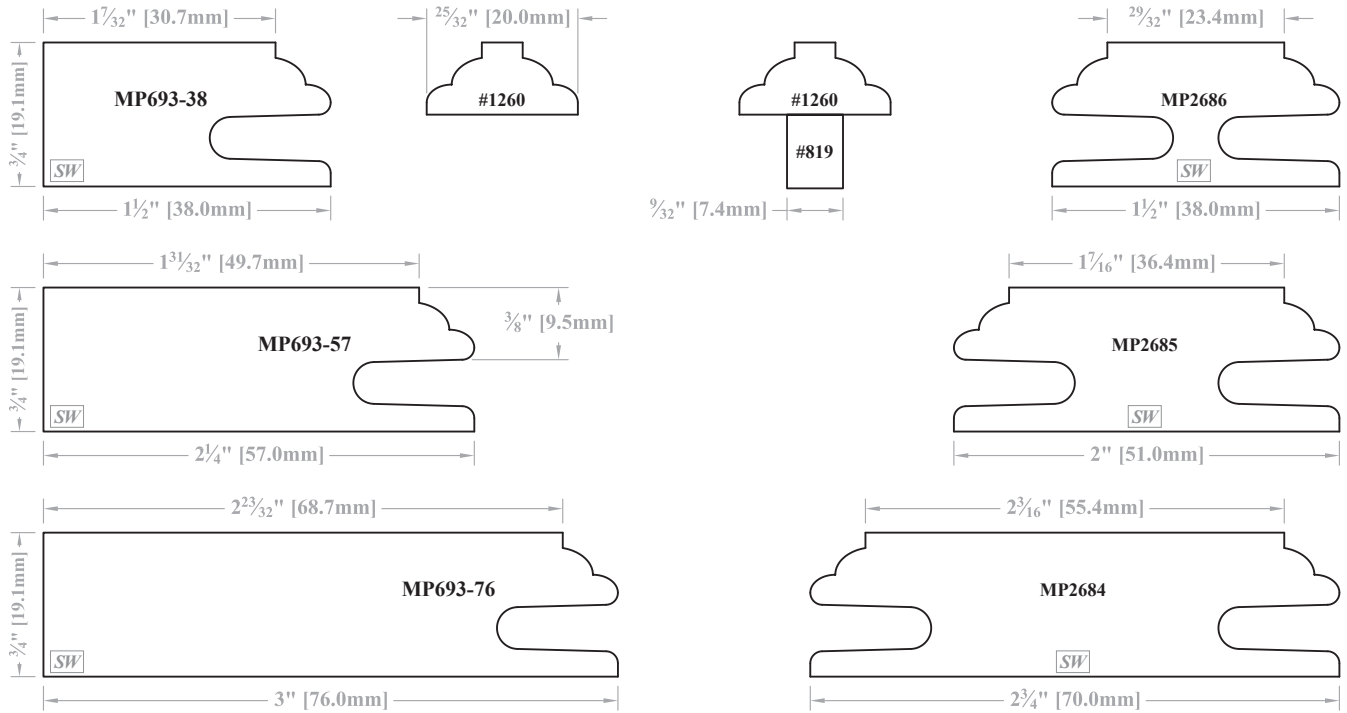

MP694 Family

* = Only available with an applied molding. See Notes.

Center Stiles & Rails will look like these profiles.

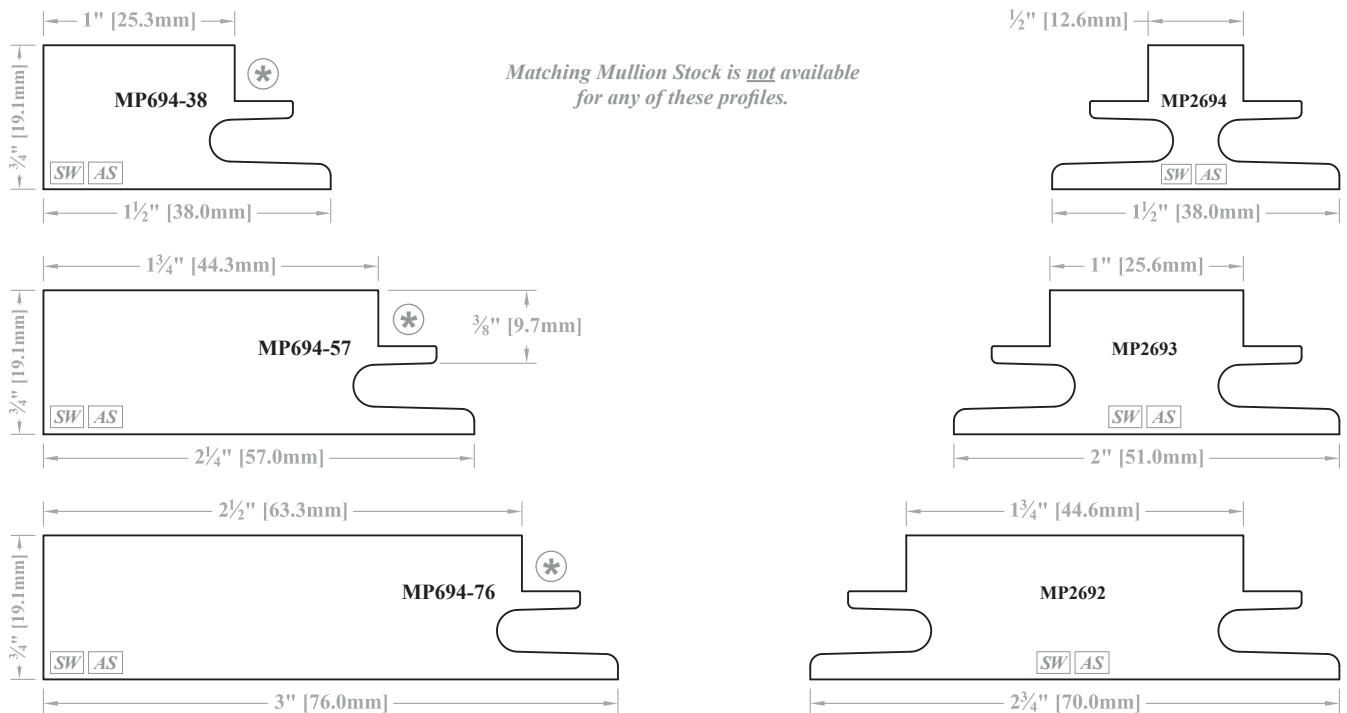

Matching Mullion Stock is **not** available for any of these profiles.

SW = Available in Solid Wood.

FM = Available for French Miter Doors.

C = Available for Convex/Concave products.

AS = Available on Adventure Series Doors.

► For PRICING ► See Section E.9 in our current Wholesale Pricing Catalog.



Mitered Stile & Rail Profiles with Matching Mullion Stock

MP695 Family

Center Stiles & Rails will look like these profiles.

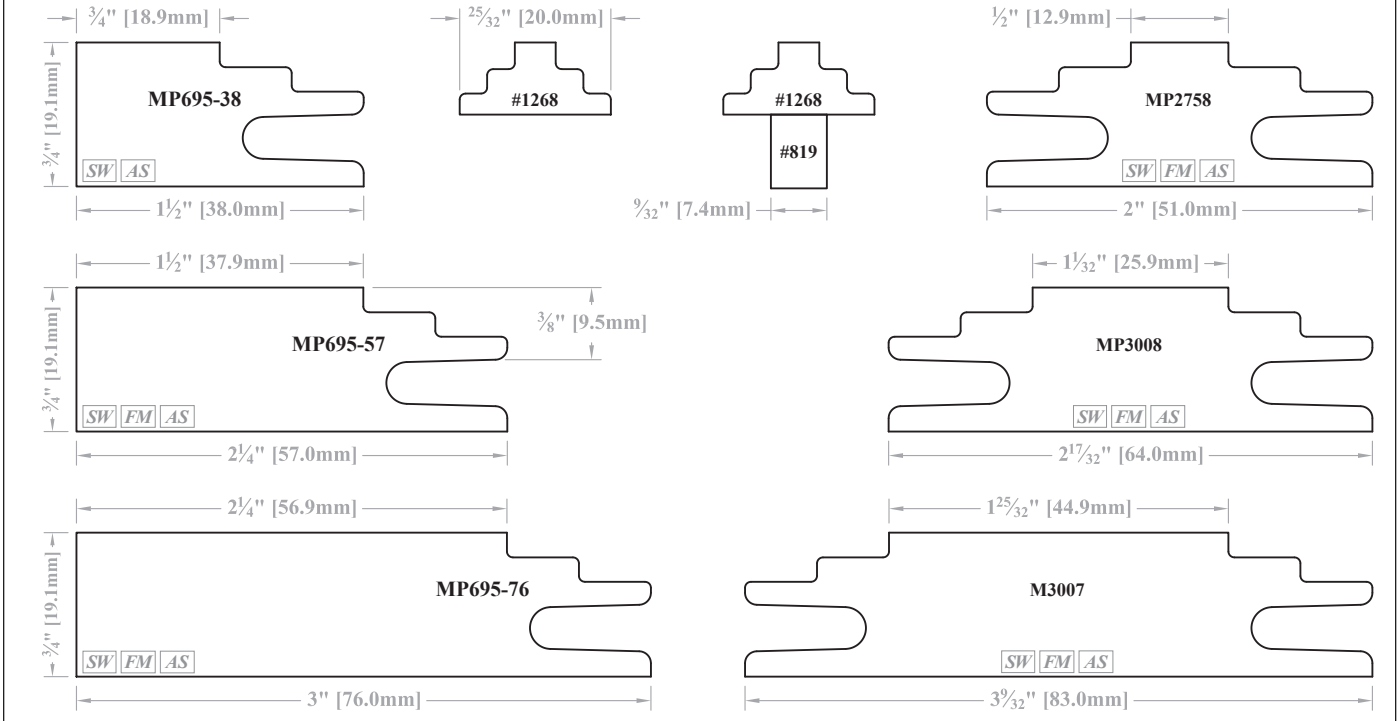

MP696 Family

Center Stiles & Rails will look like these profiles.

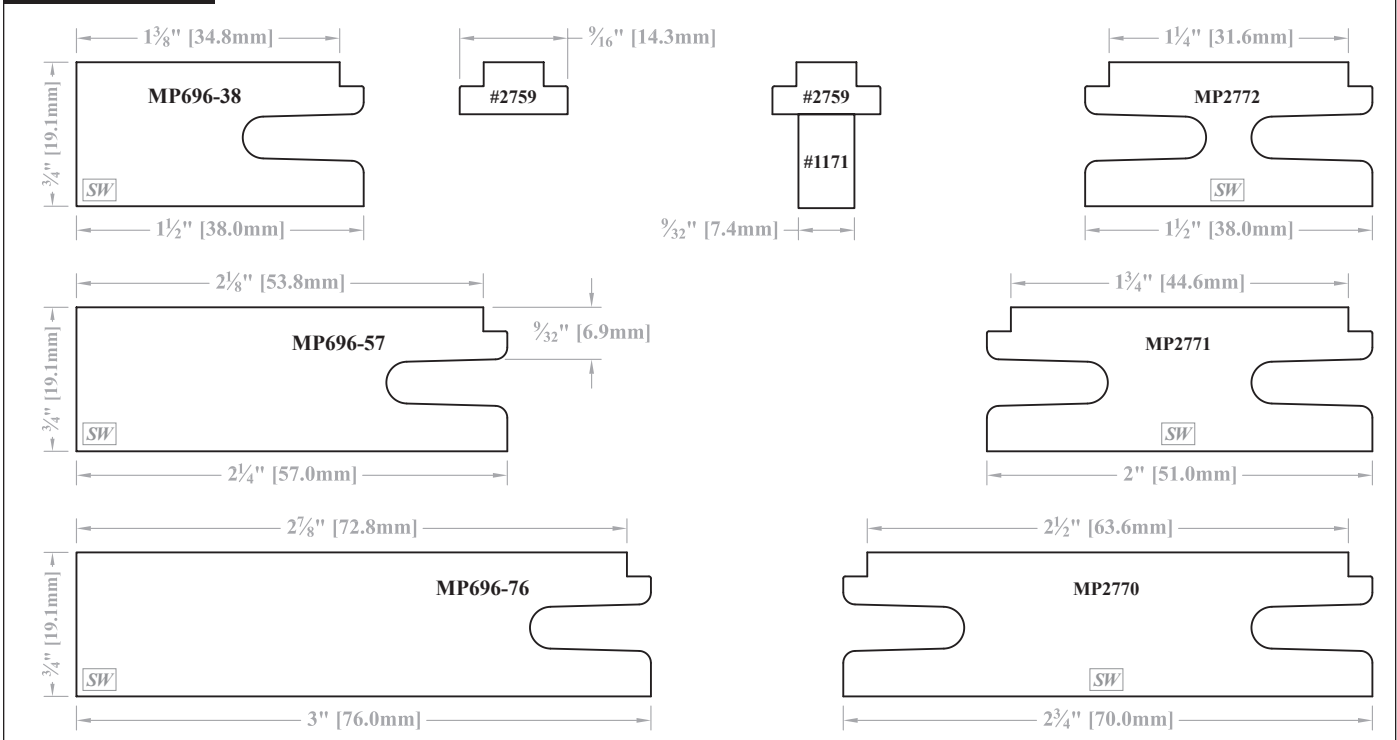

SW = Available in Solid Wood.

FM = Available for French Miter Doors.

C = Available for Convex/Concave products.

AS = Available on Adventure Series Doors.

► For PRICING ► See Section E.9 in our current Wholesale Pricing Catalog.

Profile Options

Stile & Rail - "Mitered" Mortise & Tenon Joinery - MP600/MP6000 Series

Mitered Stile & Rail Profiles with Matching Mullion Stock

MP697 Family

Center Stiles & Rails will look like these profiles.

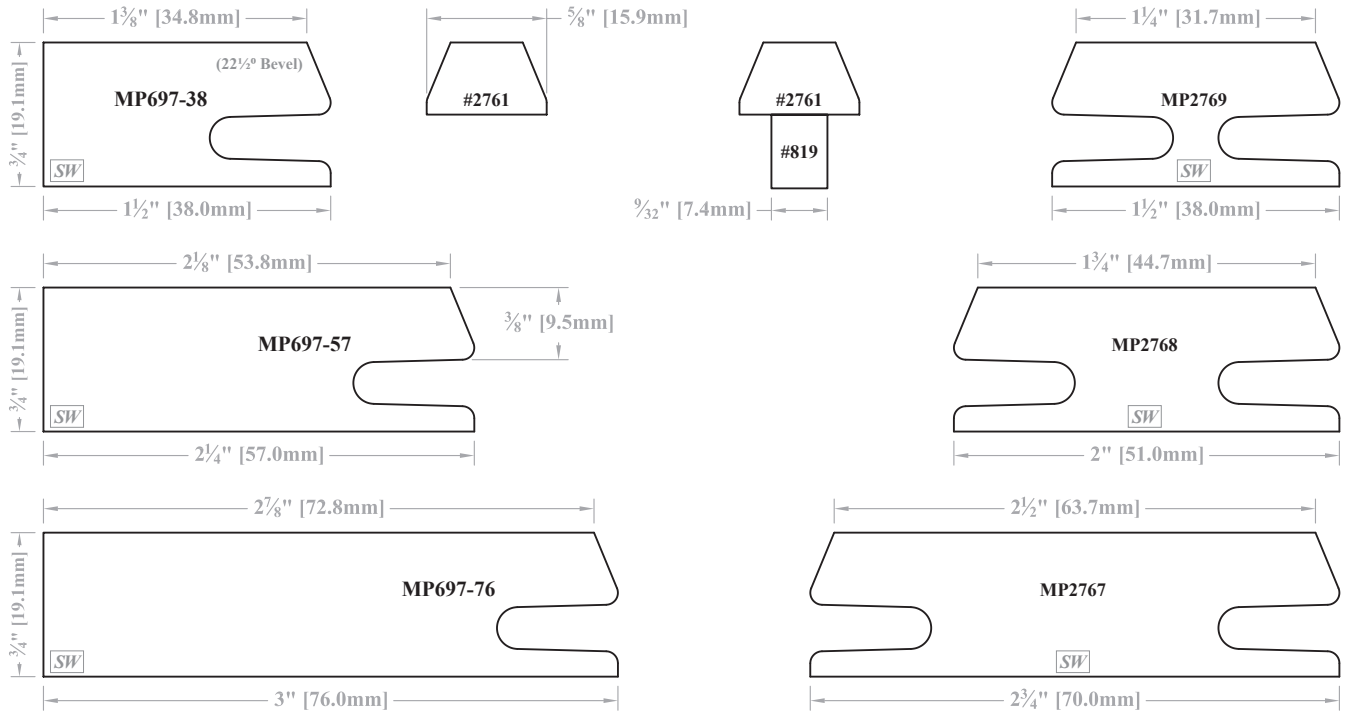

MP698 Family

Center Stiles & Rails will look like these profiles.

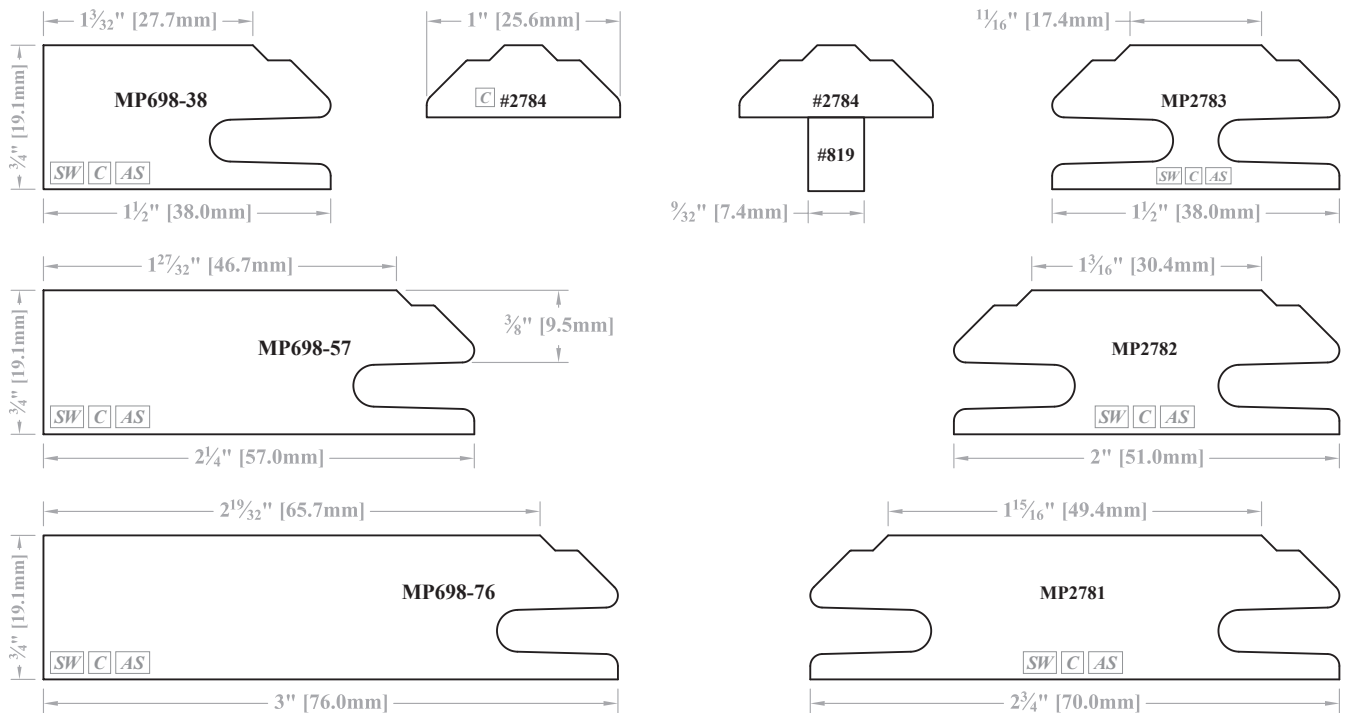

SW = Available in Solid Wood.

FM = Available for French Miter Doors.

C = Available for Convex/Concave products.

AS = Available on Adventure Series Doors.

► For PRICING ► See Section [E.9](#) in our current Wholesale Pricing Catalog.

Mitered Stile & Rail Profiles with Matching Mullion Stock

MP699 Family

Center Stiles & Rails will look like these profiles.

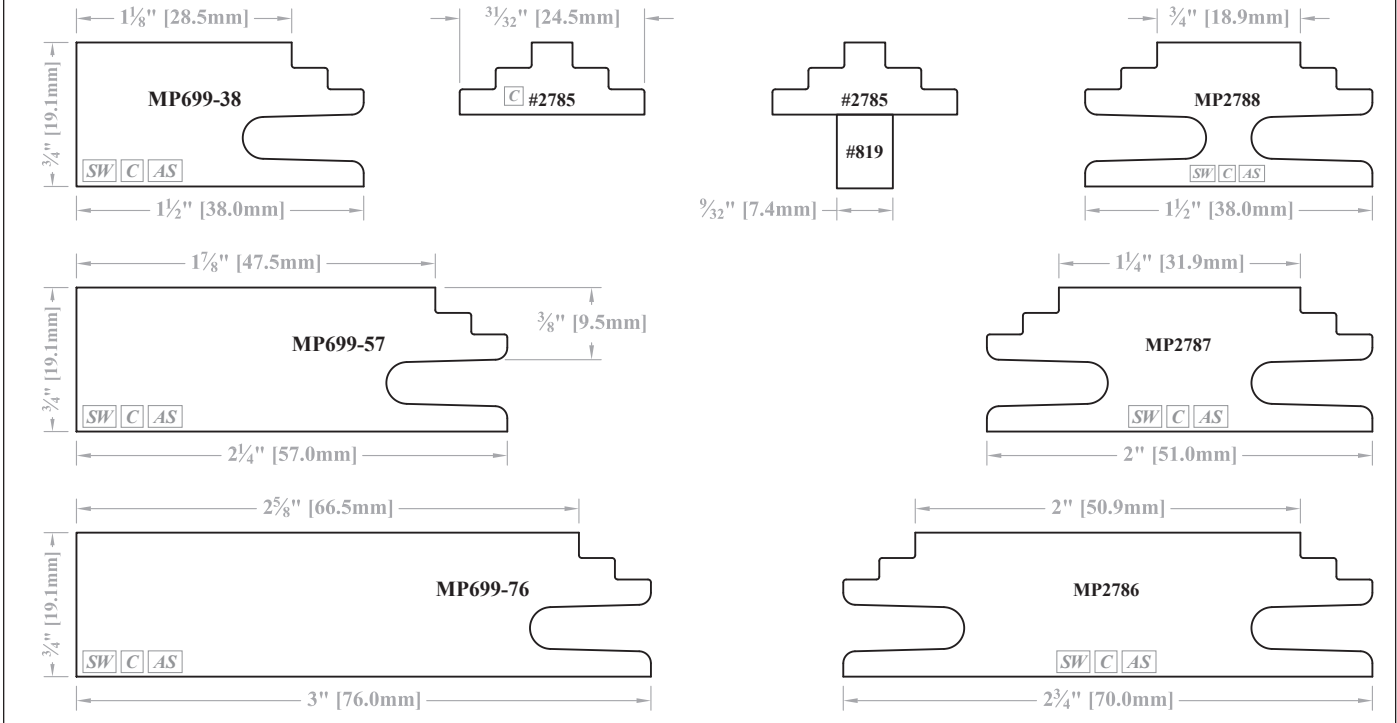

MP6100 Family

Center Stiles & Rails will look like these profiles.

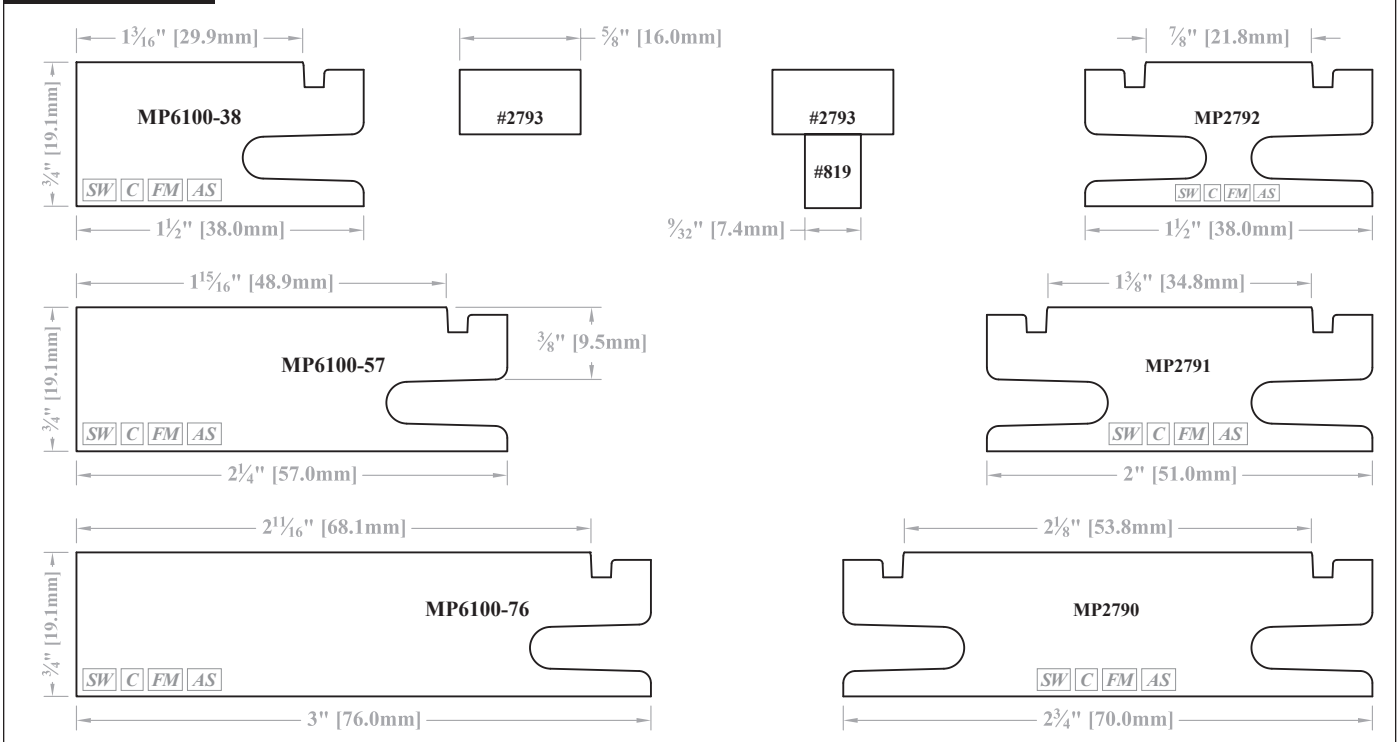

SW = Available in Solid Wood.

FM = Available for French Miter Doors.

C = Available for Convex/Concave products.

AS = Available on Adventure Series Doors.

► For PRICING ► See Section **E.9** in our current Wholesale Pricing Catalog.

Profile Options

Stile & Rail - "Mitered" Mortise & Tenon Joinery - MP600/MP6000 Series

Mitered Stile & Rail Profiles with Matching Mullion Stock

MP6101 Family

Center Stiles & Rails will look like these profiles.

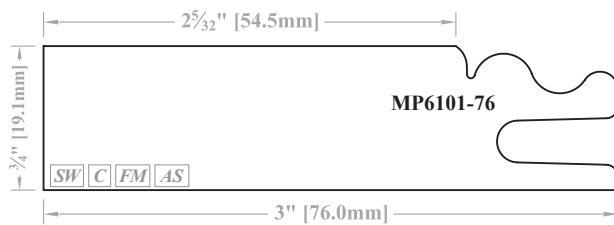
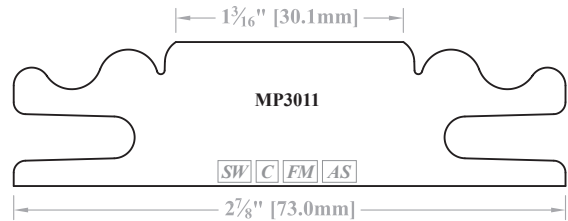
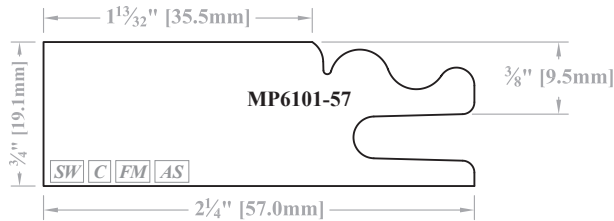
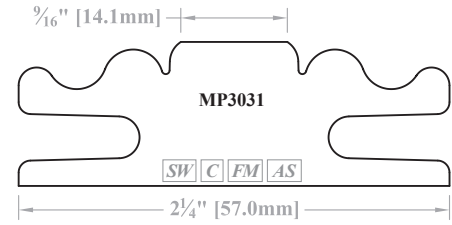
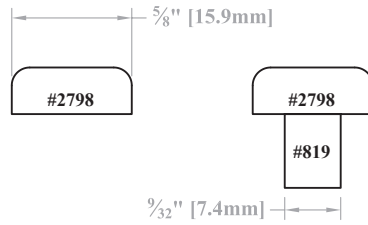
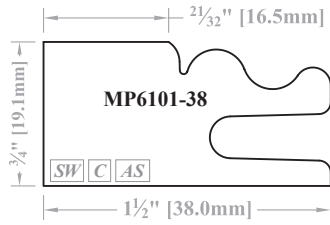

MP6101-76 uses MP3009 for center stiles & rails as shown below.

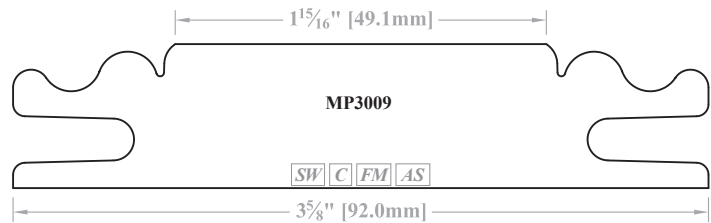

E

SW = Available in Solid Wood.

FM = Available for French Miter Doors.

C = Available for Convex/Concave products.

AS = Available on Adventure Series Doors.

► For PRICING ► See Section [E.9](#) in our current Wholesale Pricing Catalog.



Mitered Stile & Rail Profiles with Matching Mullion Stock

MP6102 Family

Center Stiles & Rails will look like these profiles.

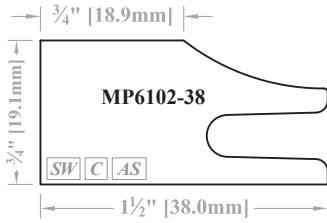

Matching Mullion Stock is not available for any of these profiles.

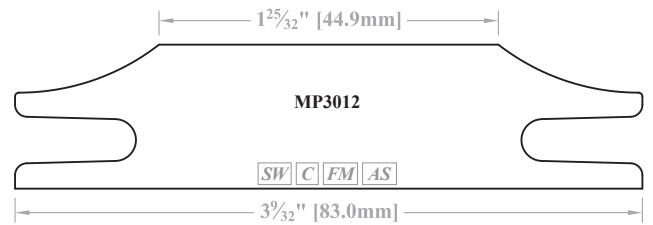
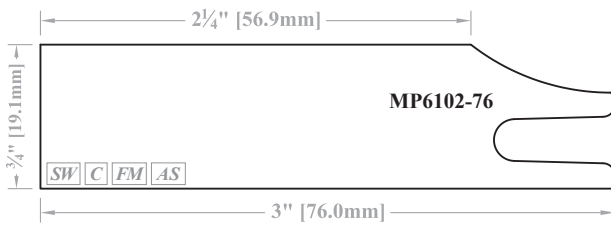
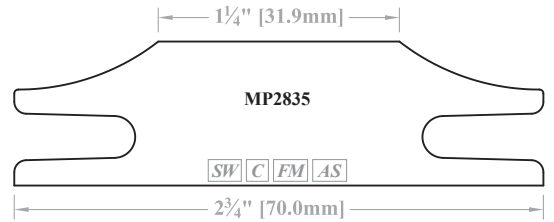
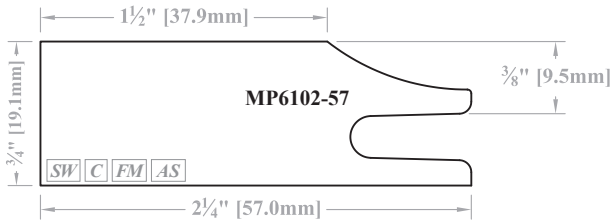
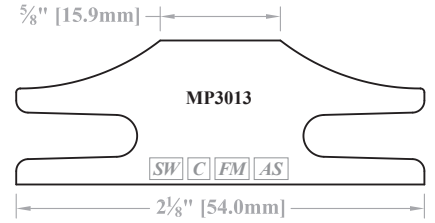

MP6105 Family

Center Stiles & Rails will look like these profiles.

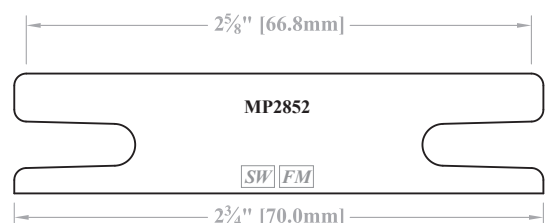
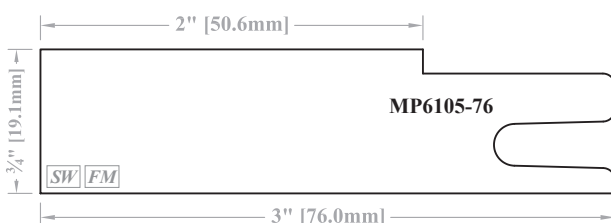
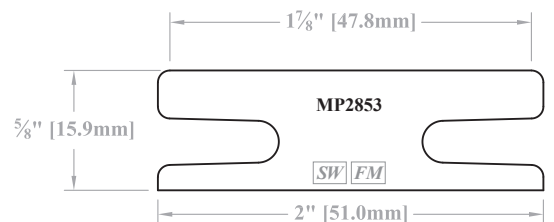
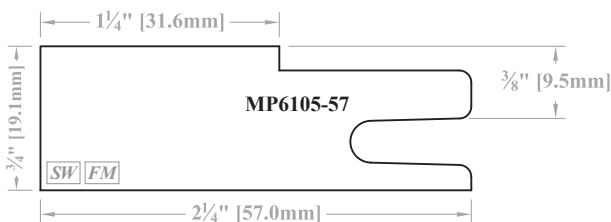
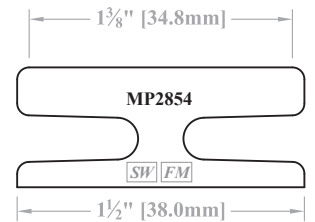
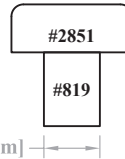
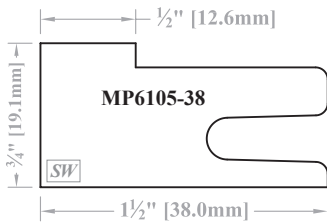

SW = Available in Solid Wood.

FM = Available for French Miter Doors.

C = Available for Convex/Concave products.

AS = Available on Adventure Series Doors.

► For PRICING ► See Section E.9 in our current Wholesale Pricing Catalog.

Profile Options

Stile & Rail - "Mitered" Mortise & Tenon Joinery - MP600/MP6000 Series

Mitered Stile & Rail Profiles with Matching Mullion Stock

MP6103 Family

Center Stiles & Rails will look like these profiles.

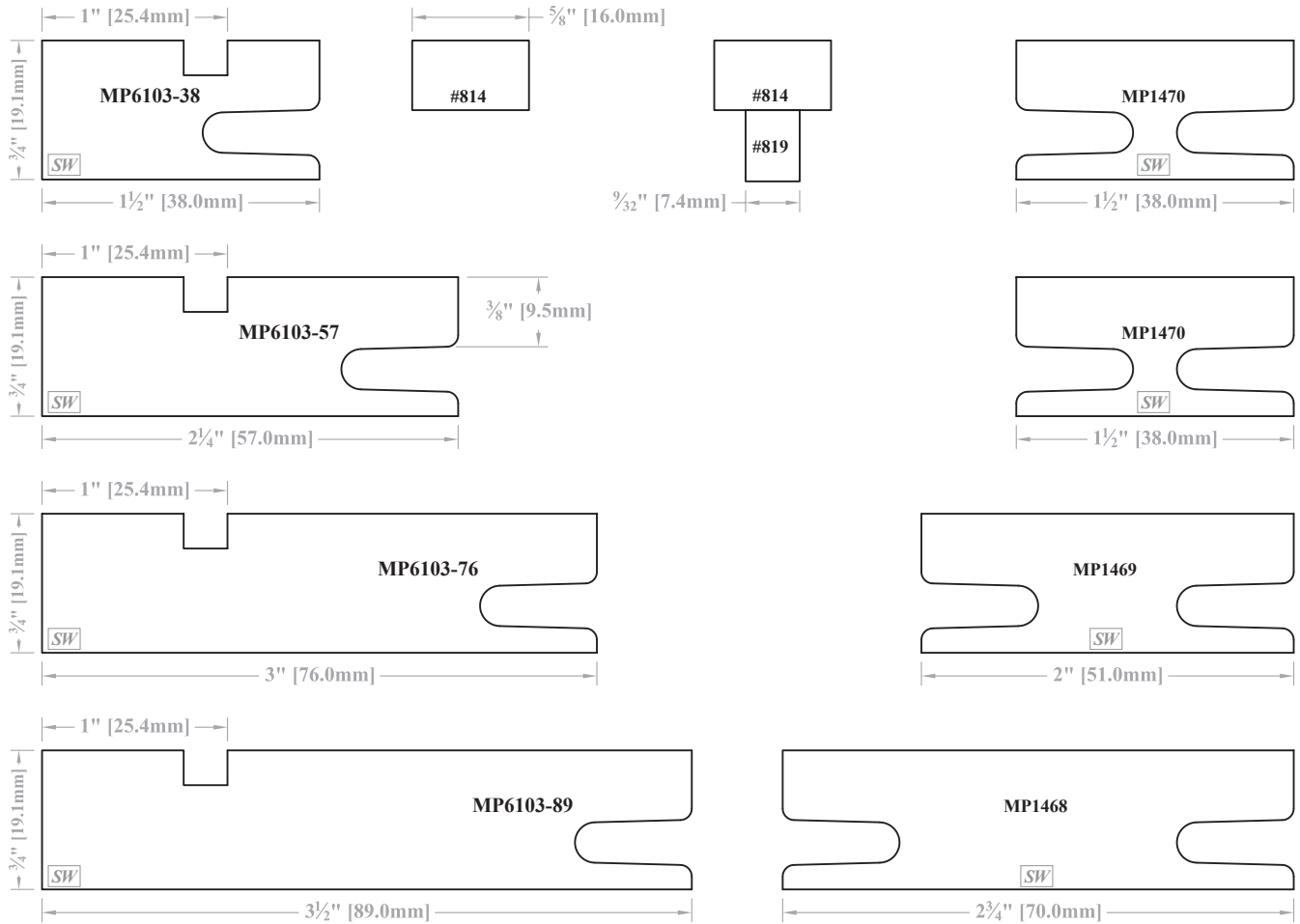

This family was created to simulate the look of a face frame and inset door.

SW = Available in Solid Wood.

FM = Available for French Miter Doors.

C = Available for Convex/Concave products.

AS = Available on Adventure Series Doors.

► For PRICING ► See Section [E.9](#) in our current Wholesale Pricing Catalog.

E.9.57
V19.1



WalzCraft.com



(Phone) 1-800-237-1326 6:00AM - 5:30PM CST (24 Hour Fax) 1-608-781-3667

Mitered Stile & Rail Profiles with Matching Mullion Stock

MP6104 Family

Center Stiles & Rails will look like these profiles.

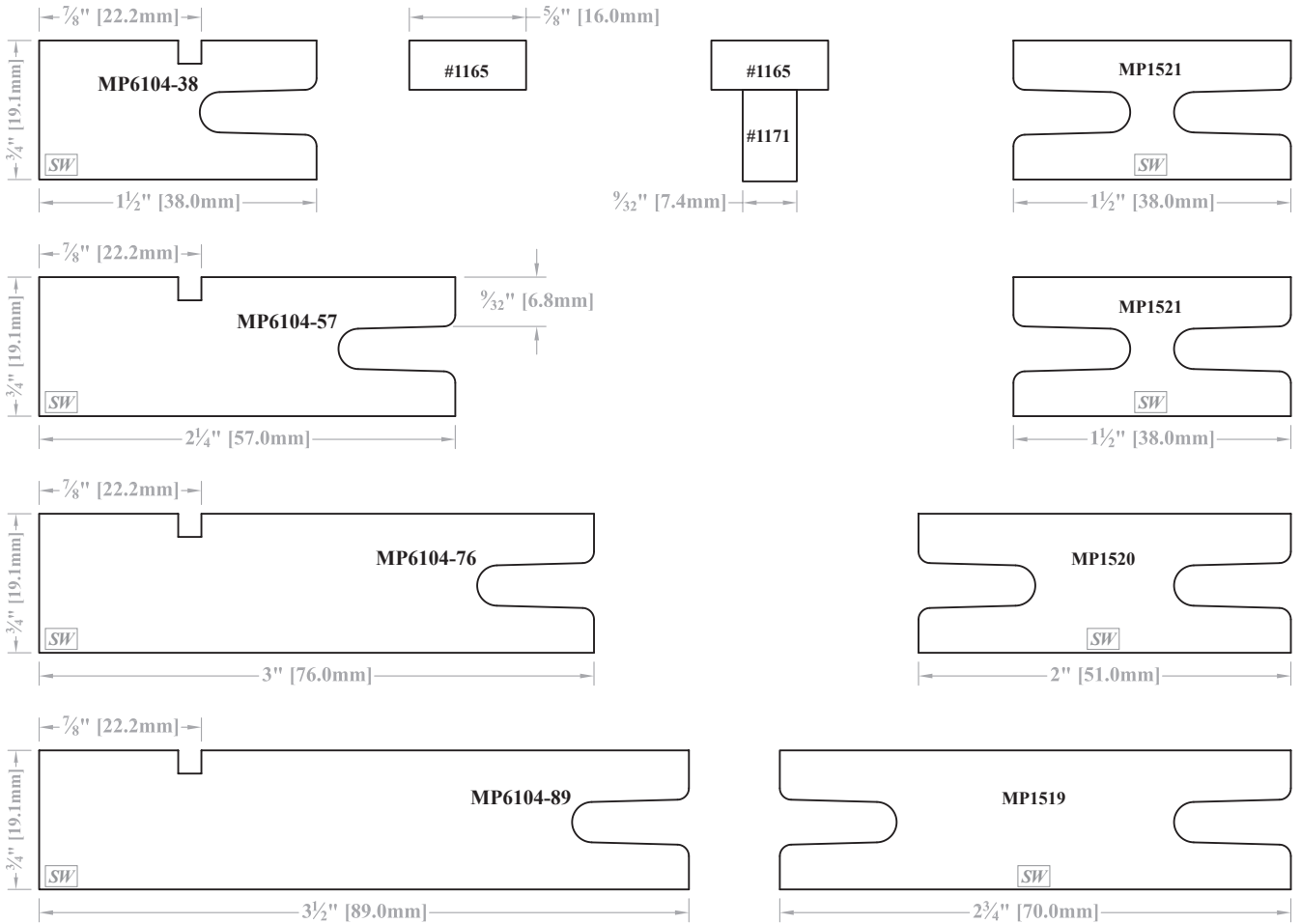

This family was created to simulate the look of a face frame and inset door.

E

SW = Available in Solid Wood. **FM** = Available for French Miter Doors. **C** = Available for Convex/Concave products. **AS** = Available on Adventure Series Doors.

► For PRICING ► See Section [E.9](#) in our current Wholesale Pricing Catalog.

Profile Options

Stile & Rail - "Mitered" Mortise & Tenon Joinery - MP600/MP6000 Series

Mitered Stile & Rail Profiles with Matching Mullion Stock

MP6106 Family

Center Stiles & Rails will look like these profiles.

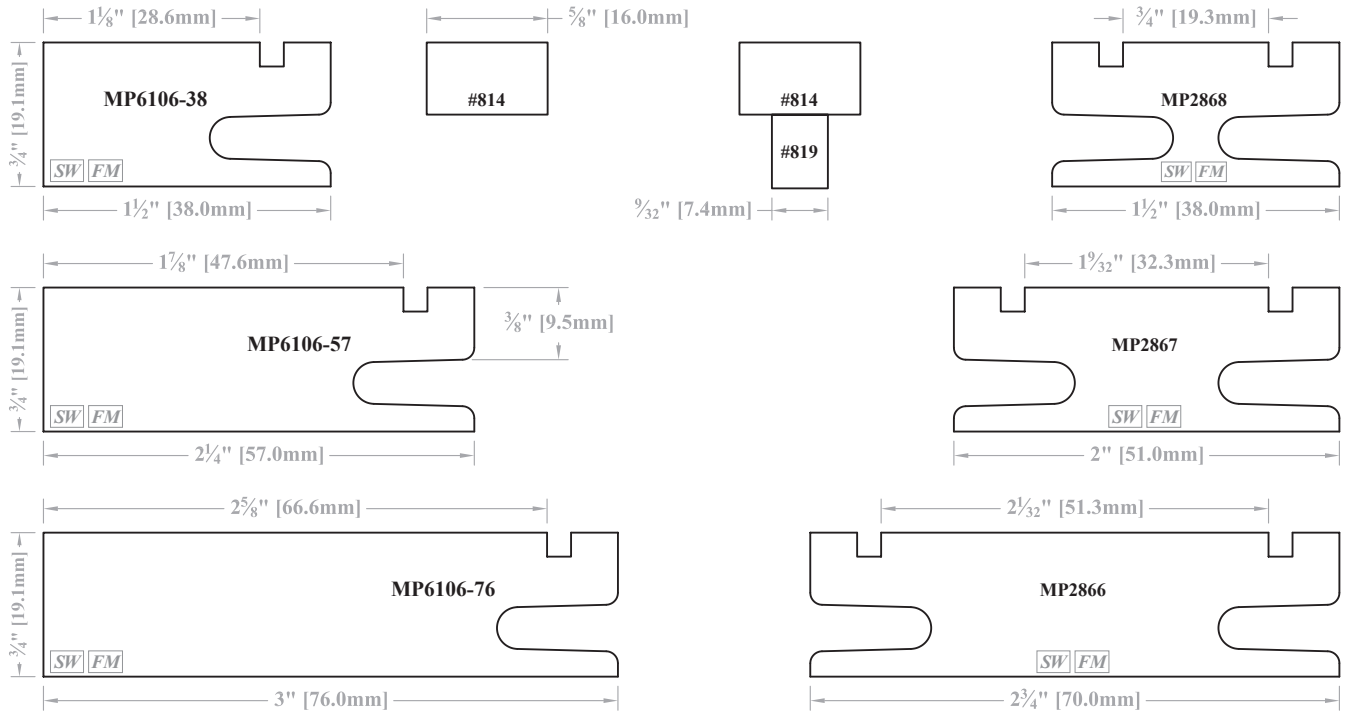

MP6107 Family

Center Stiles & Rails will look like these profiles.

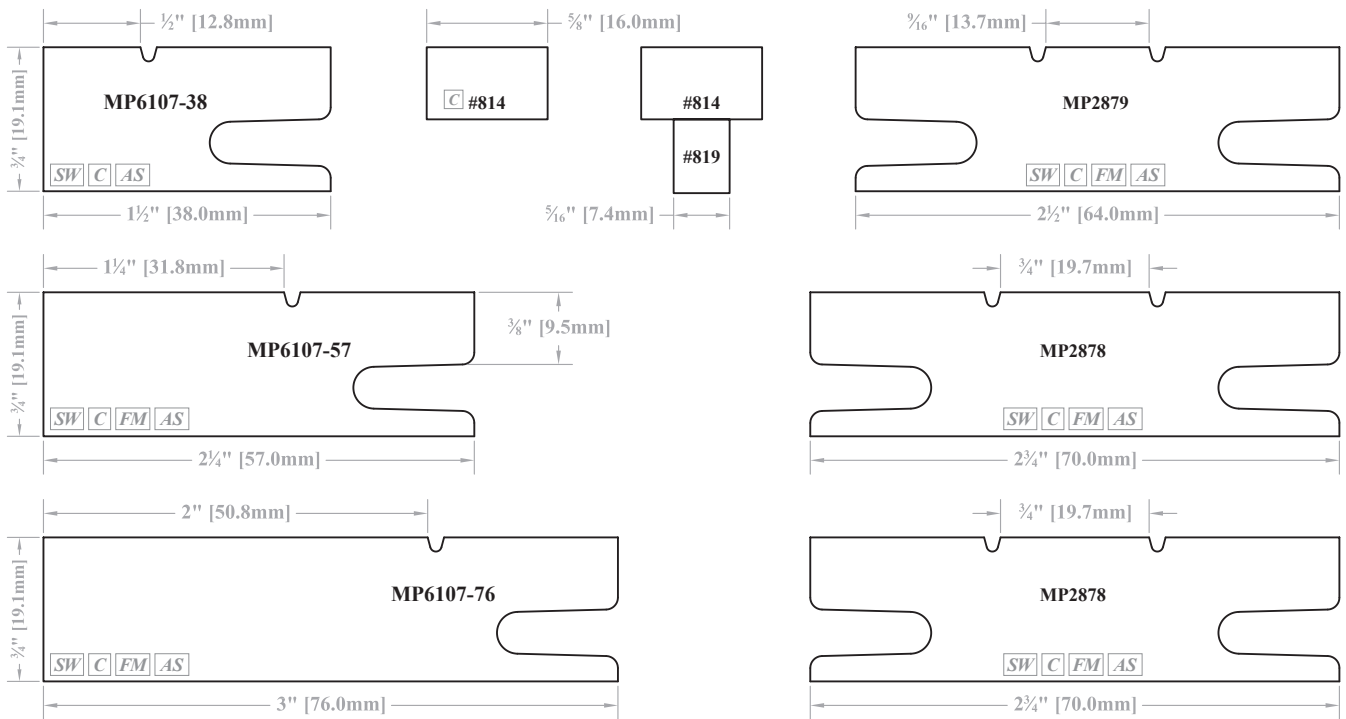

SW = Available in Solid Wood.

FM = Available for French Miter Doors.

C = Available for Convex/Concave products.

AS = Available on Adventure Series Doors.

► For PRICING ► See Section E.9 in our current Wholesale Pricing Catalog.



Mitered Stile & Rail Profiles with Matching Mullion Stock

MP6108 Family

Center Stiles & Rails will look like these profiles.

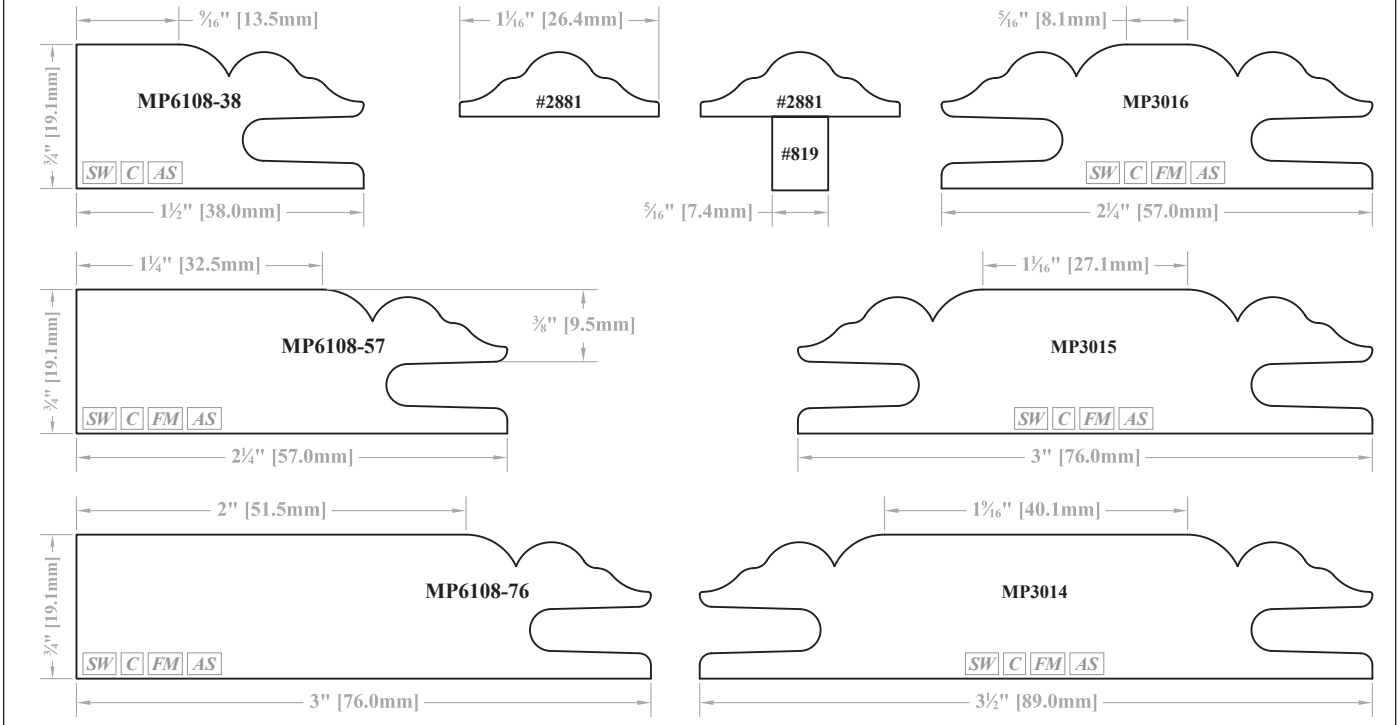

MP6109 Family

Center Stiles & Rails will look like these profiles.

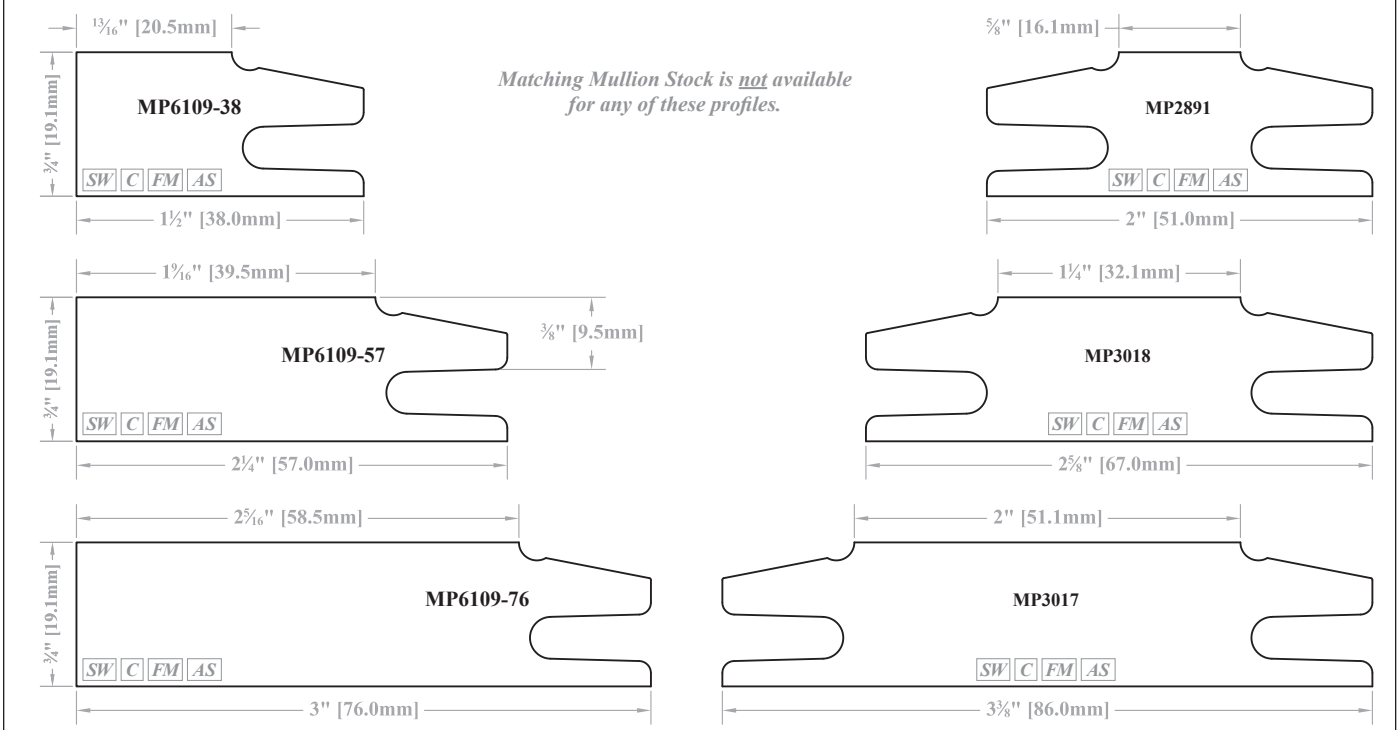

SW = Available in Solid Wood. FM = Available for French Miter Doors. C = Available for Convex/Concave products. AS = Available on Adventure Series Doors.

Profile Options

Stile & Rail - "Mitered" Mortise & Tenon Joinery - MP600/MP6000 Series

Mitered Stile & Rail Profiles with Matching Mullion Stock

MP6110 Family

Center Stiles & Rails will look like these profiles.

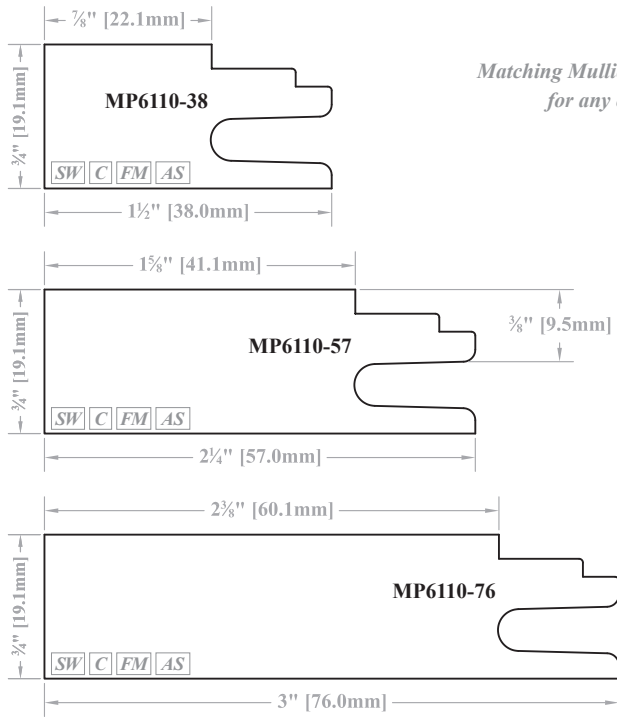

Matching Mullion Stock is not available for any of these profiles.

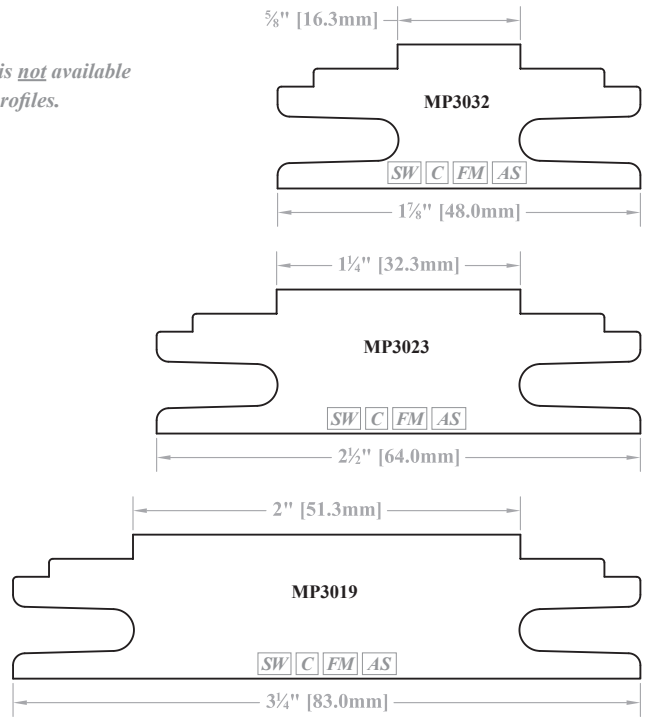

MP6111 Family

(X) = Applied Molding Shelf, molding is optional

Center Stiles & Rails will look like these profiles.

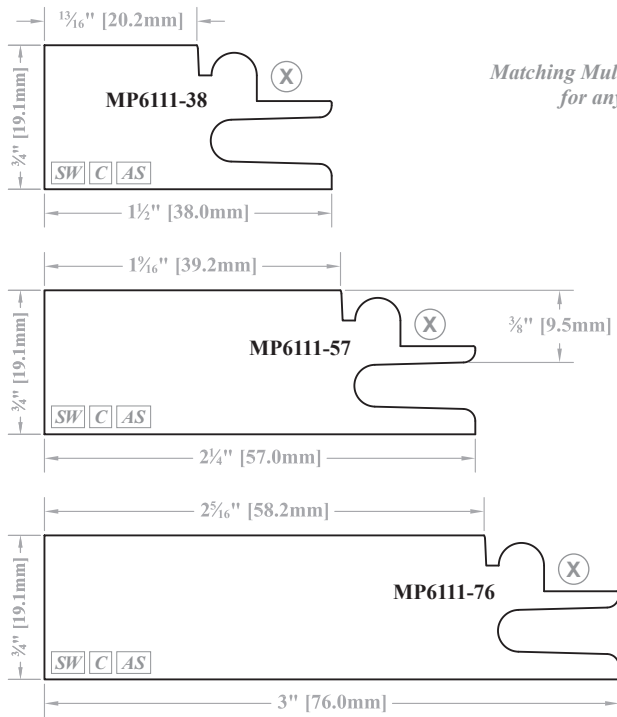

Matching Mullion Stock is not available for any of these profiles.

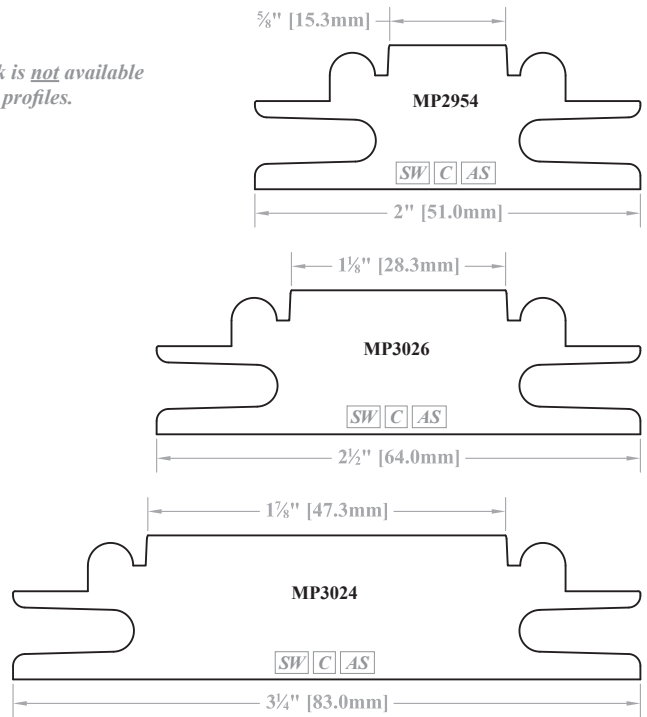

SW = Available in Solid Wood.

FM = Available for French Miter Doors.

C = Available for Convex/Concave products.

AS = Available on Adventure Series Doors.

► For PRICING ► See Section E.9 in our current Wholesale Pricing Catalog.



Mitered Stile & Rail Profiles with Matching Mullion Stock

MP6112 Family

Center Stiles & Rails will look like these profiles.

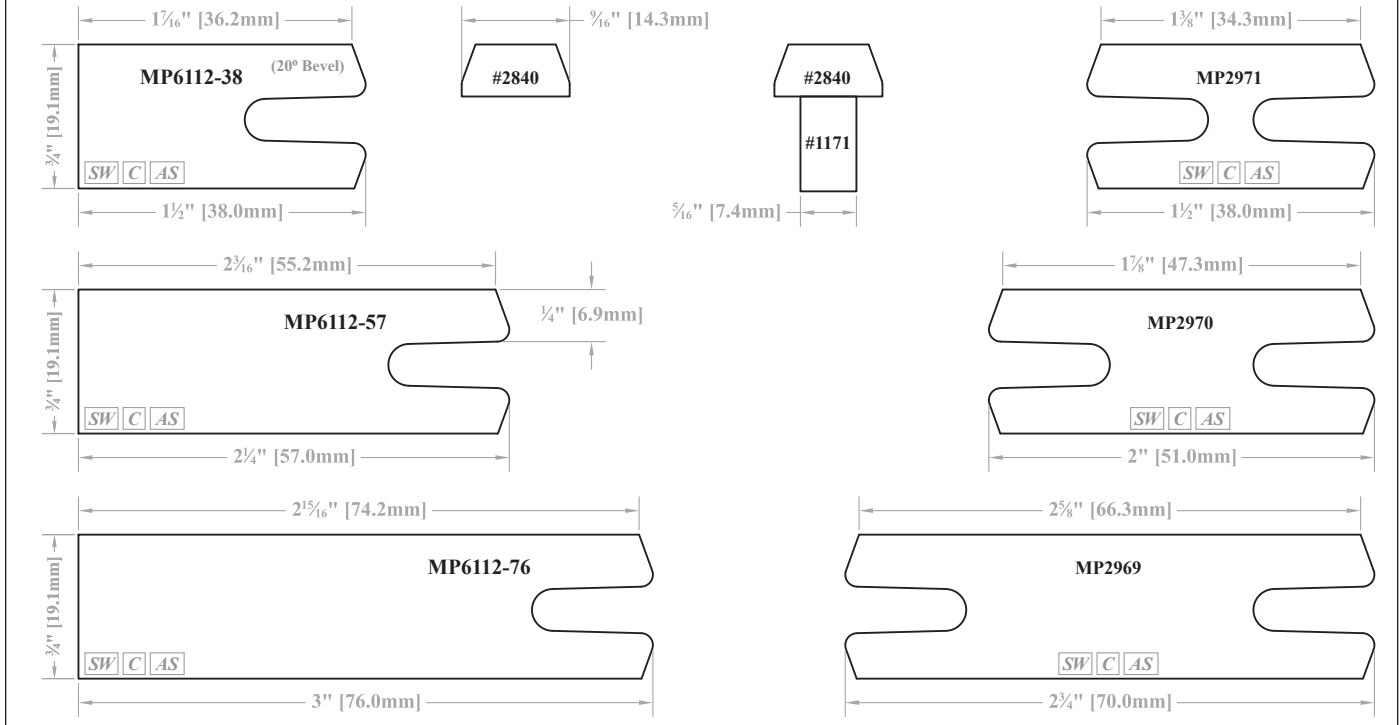

MP6113 Family

Center Stiles & Rails will look like these profiles.

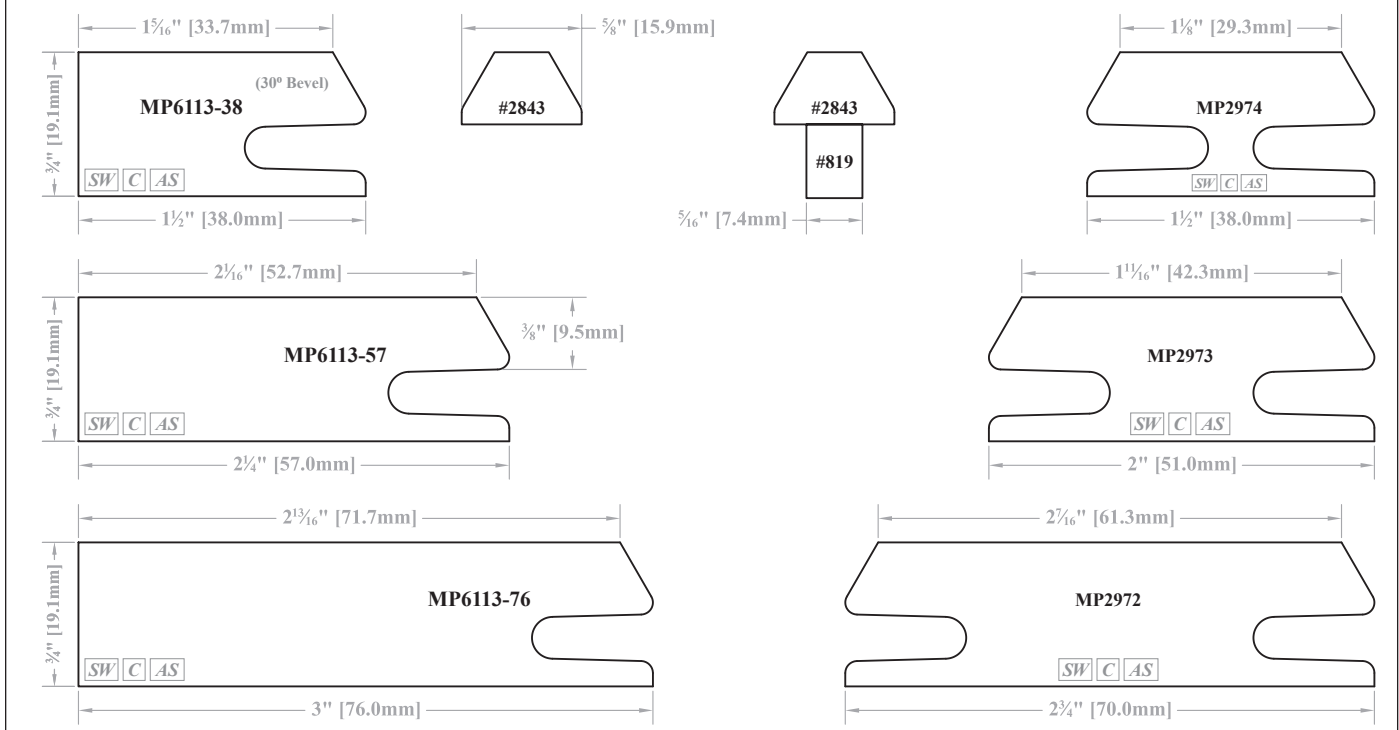

[SW] = Available in Solid Wood.

[FM] = Available for French Miter Doors.

[C] = Available for Convex/Concave products.

[AS] = Available on Adventure Series Doors.

► For PRICING ► See Section E.9 in our current Wholesale Pricing Catalog.

Profile Options

Stile & Rail - "Mitered" Mortise & Tenon Joinery - MP600/MP6000 Series

Mitered Stile & Rail Profiles with Matching Mullion Stock

MP6114 Family

Center Stiles & Rails will look like these profiles.

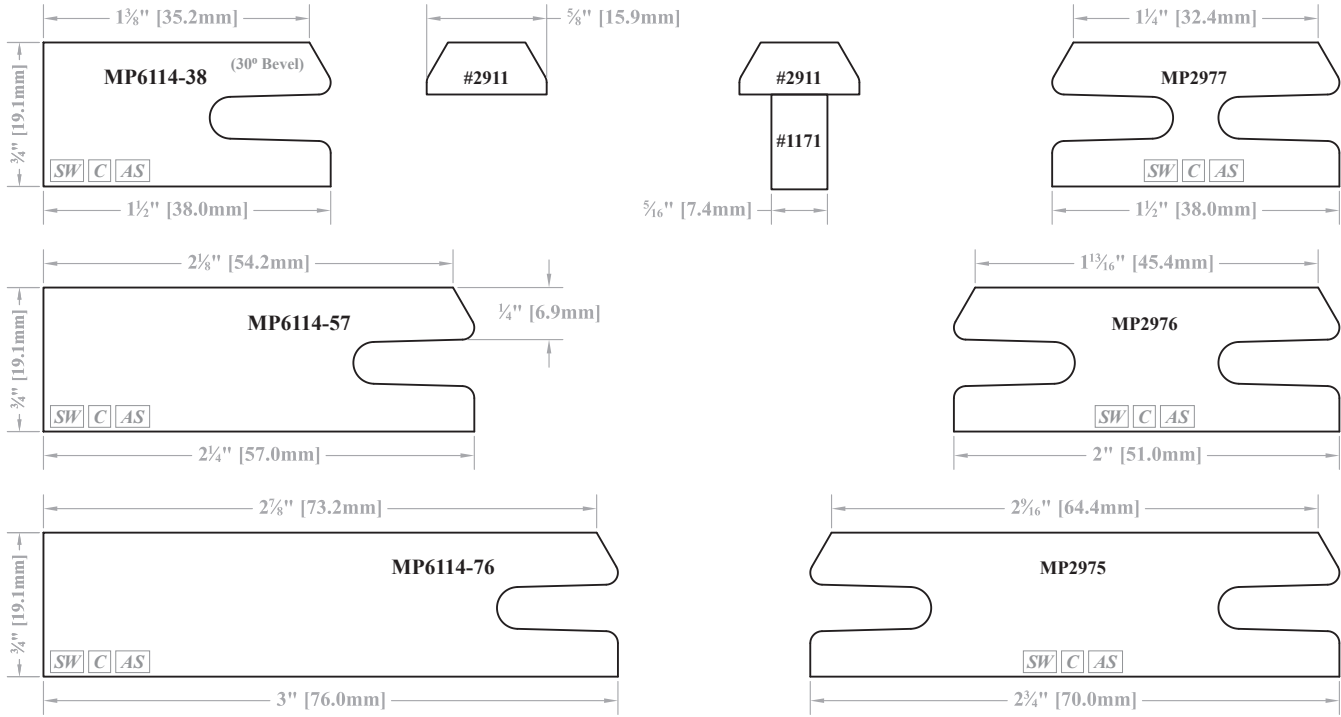

MP6115 Family

Center Stiles & Rails will look like these profiles.

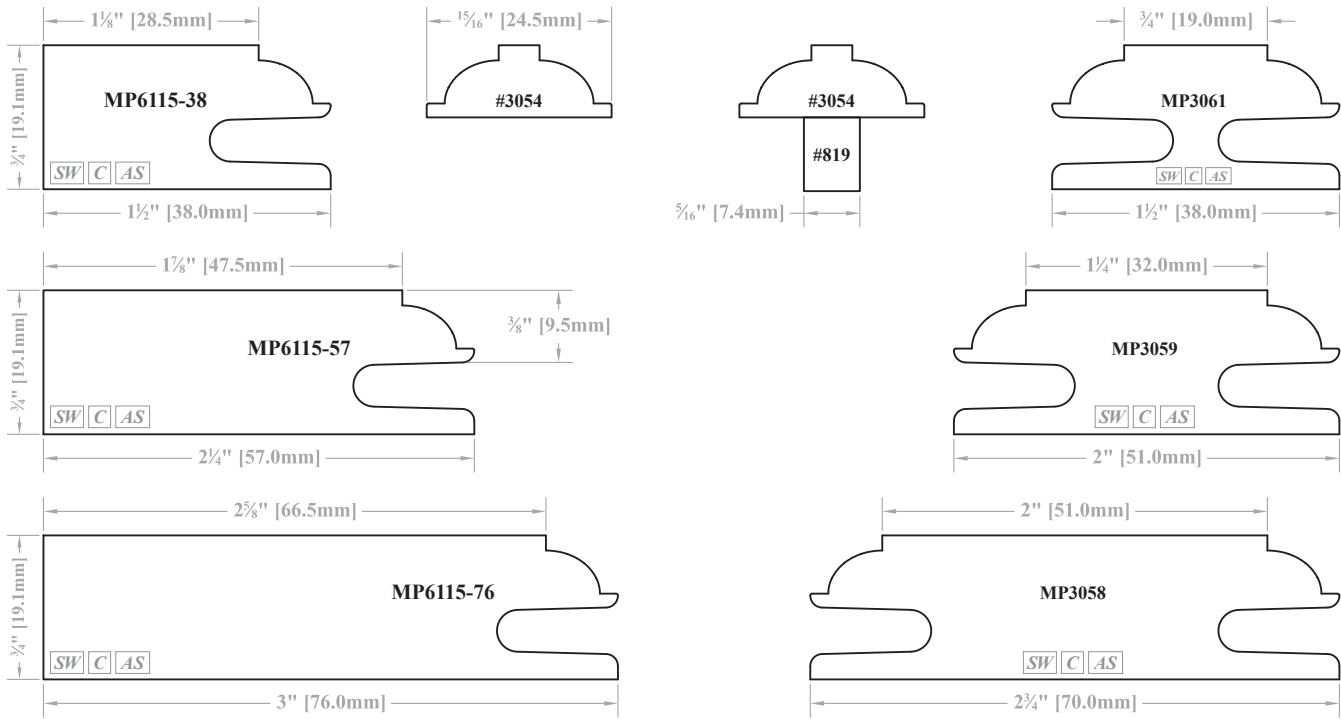

SW = Available in Solid Wood.

FM = Available for French Miter Doors.

C = Available for Convex/Concave products.

AS = Available on Adventure Series Doors.

► For PRICING ► See Section [E.9](#) in our current Wholesale Pricing Catalog.

Mitered Stile & Rail Profiles with Matching Mullion Stock

MP6116 Family

Center Stiles & Rails will look like these profiles.

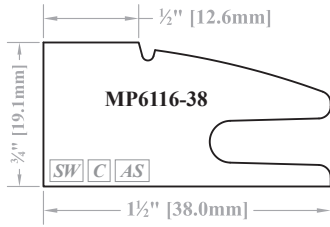

Matching Mullion Stock is not available for any of these profiles.

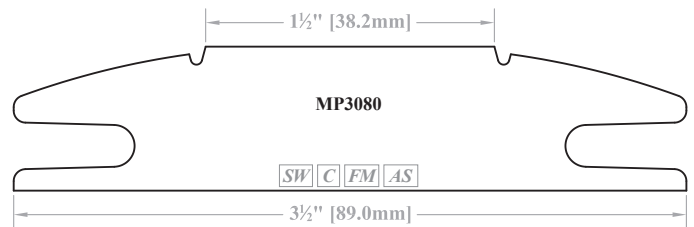
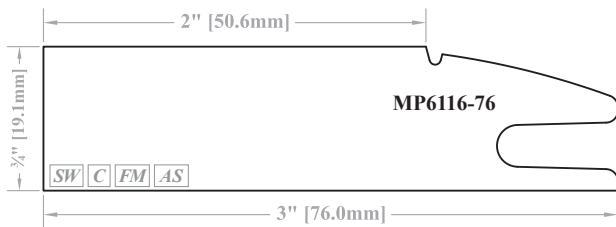
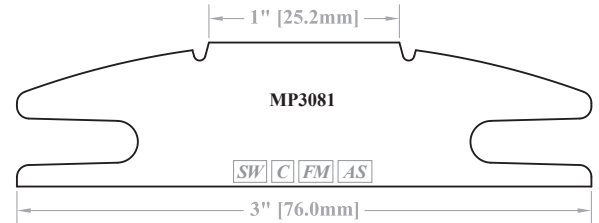
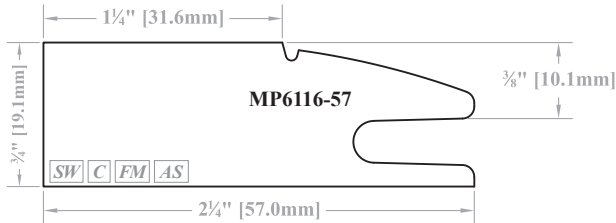
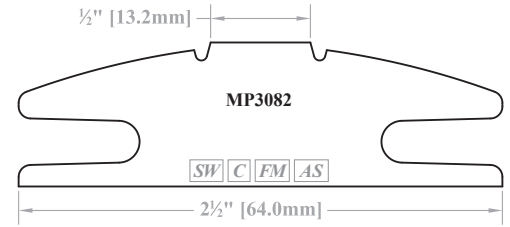

E

SW = Available in Solid Wood.

FM = Available for French Miter Doors.

C = Available for Convex/Concave products.

AS = Available on Adventure Series Doors.

► For PRICING ► See Section E.9 in our current Wholesale Pricing Catalog.

Mitered Stile & Rail Profiles with Matching Mullion Stock

MP6117 Family

Center Stiles & Rails will look like these profiles.

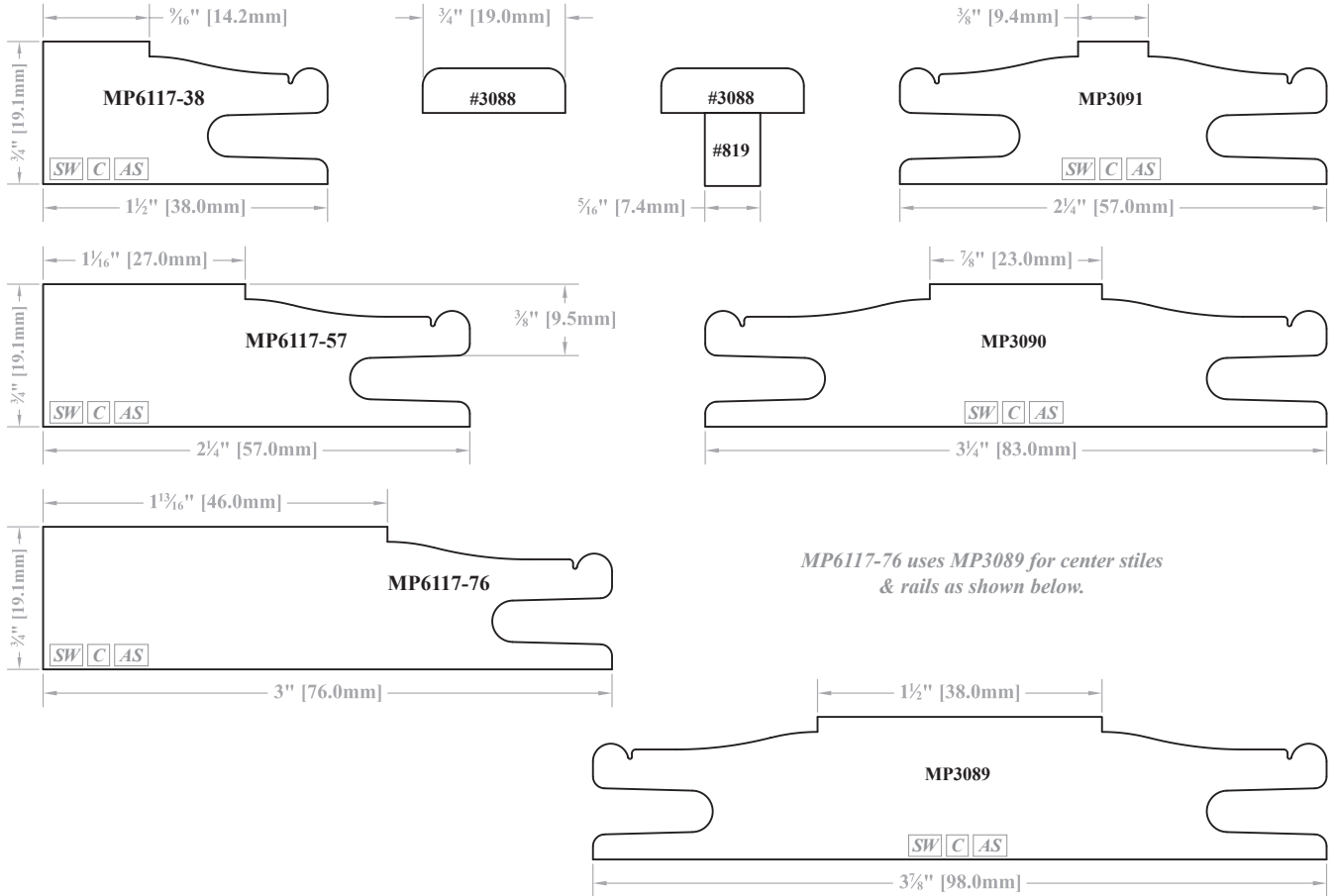

SW = Available in Solid Wood.

FM = Available for French Miter Doors.

C = Available for Convex/Concave products.

AS = Available on Adventure Series Doors.

► For PRICING ► See Section [E.9](#) in our current Wholesale Pricing Catalog.

Mitered Stile & Rail Profiles with Matching Mullion Stock

MP6118 Family

Center Stiles & Rails will look like these profiles.

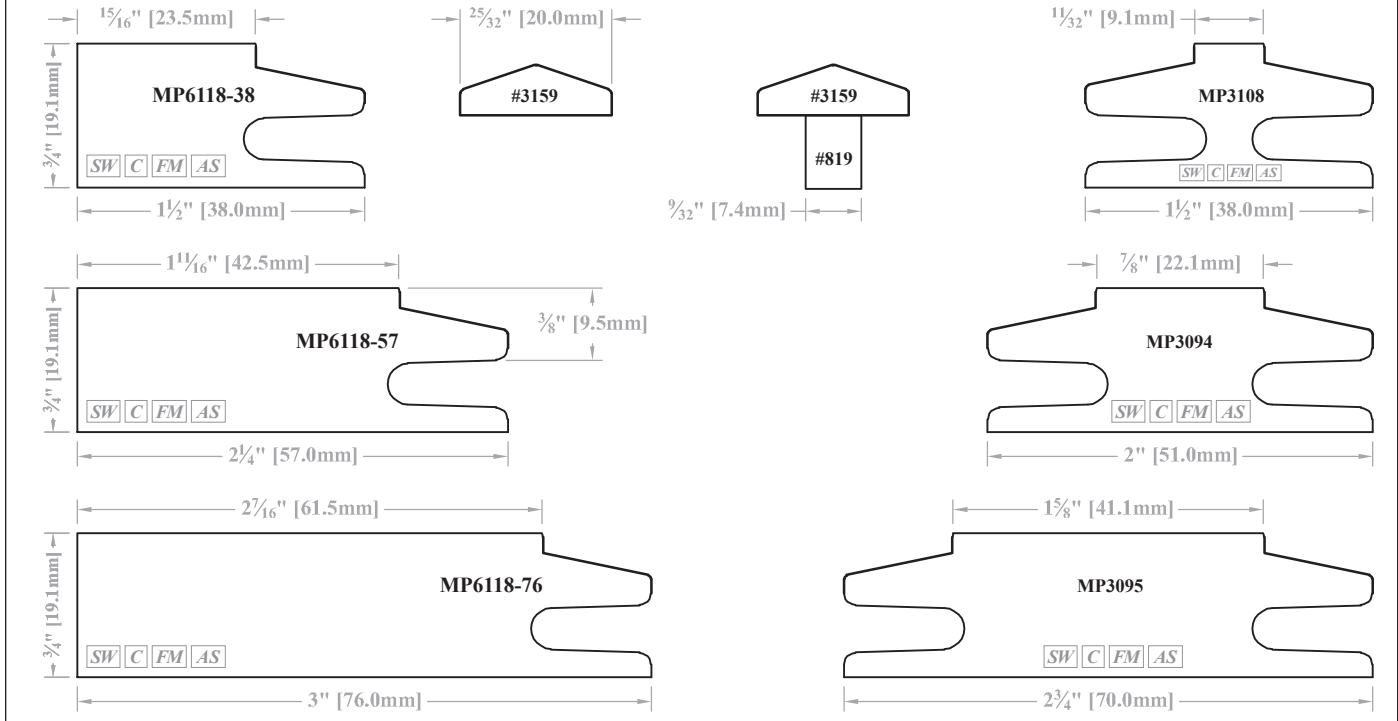

MP6119 Family

Center Stiles & Rails will look like these profiles.

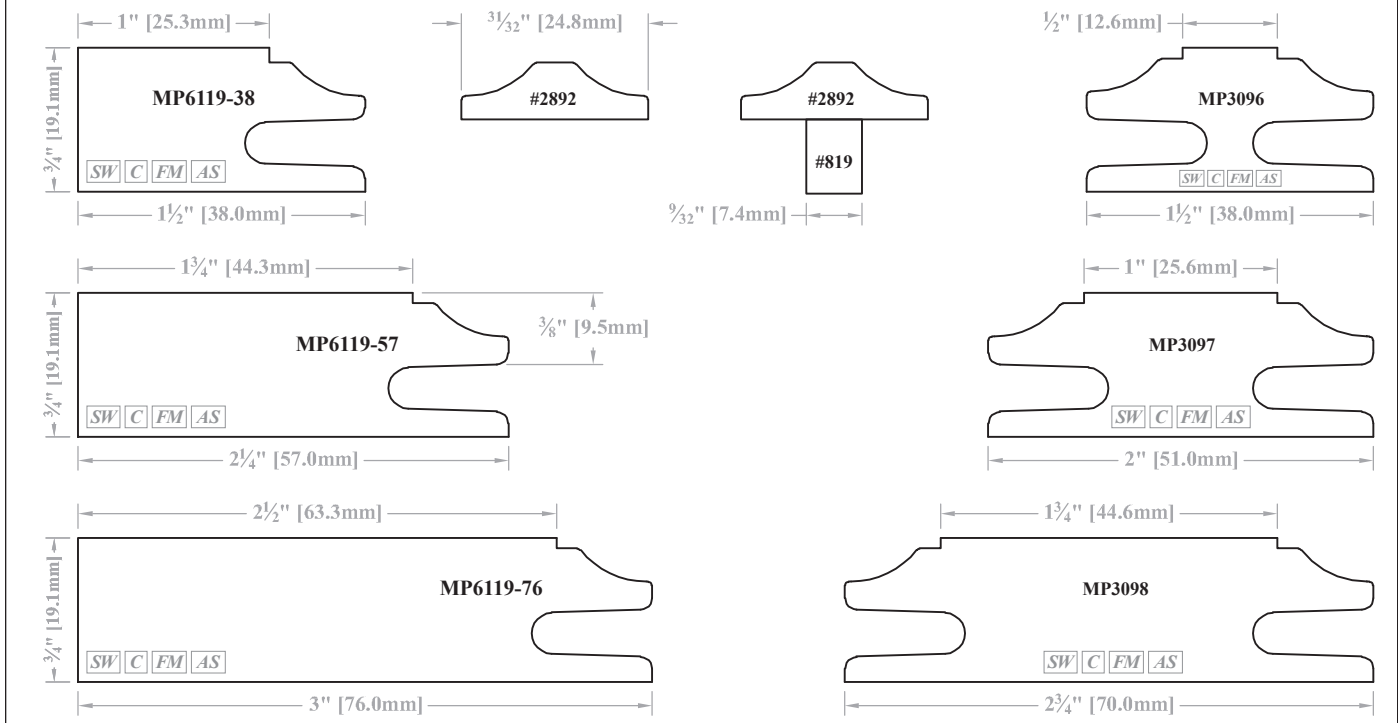

[SW] = Available in Solid Wood. [FM] = Available for French Miter Doors. [C] = Available for Convex/Concave products. [AS] = Available on Adventure Series Doors.

► For PRICING ► See Section E.9 in our current Wholesale Pricing Catalog.

Profile Options

Stile & Rail - "Mitered" Mortise & Tenon Joinery - MP600/MP6000 Series

Mitered Stile & Rail Profiles with Matching Mullion Stock

MP6120 Family

Center Stiles & Rails will look like these profiles.

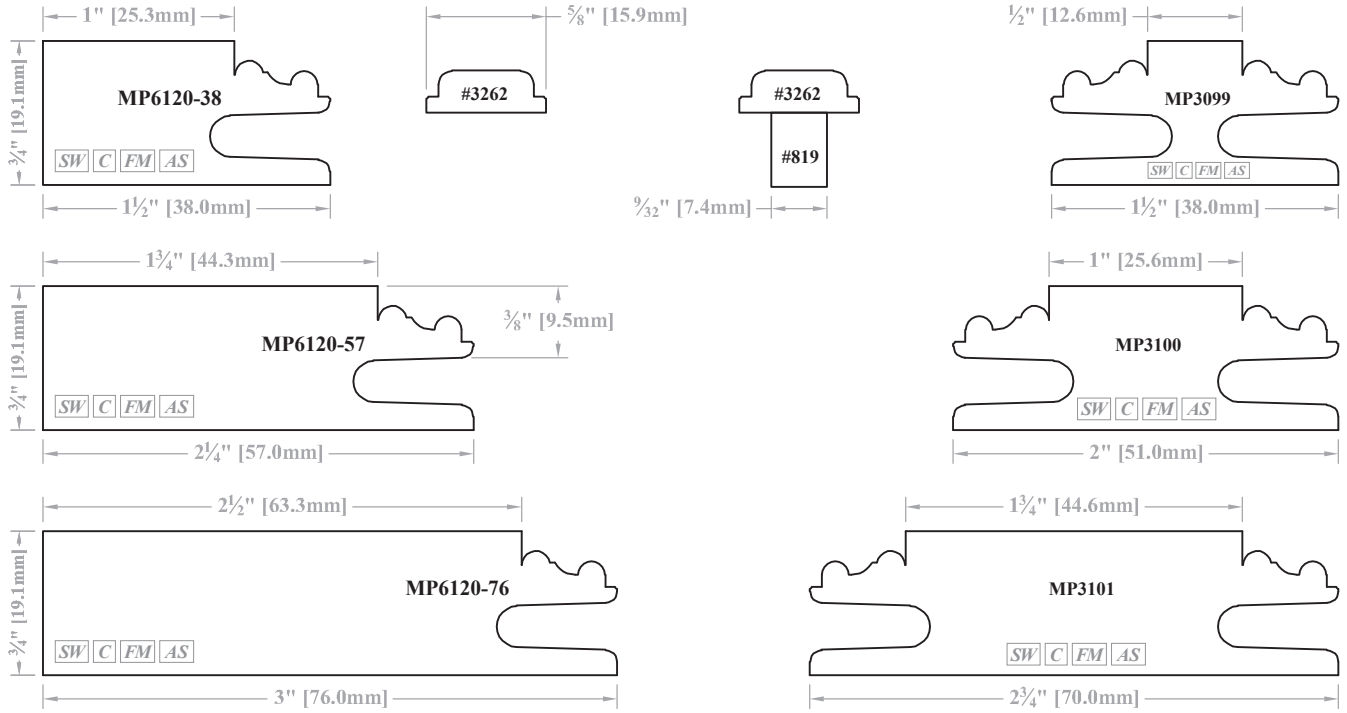

MP6121 Family

Center Stiles & Rails will look like these profiles.

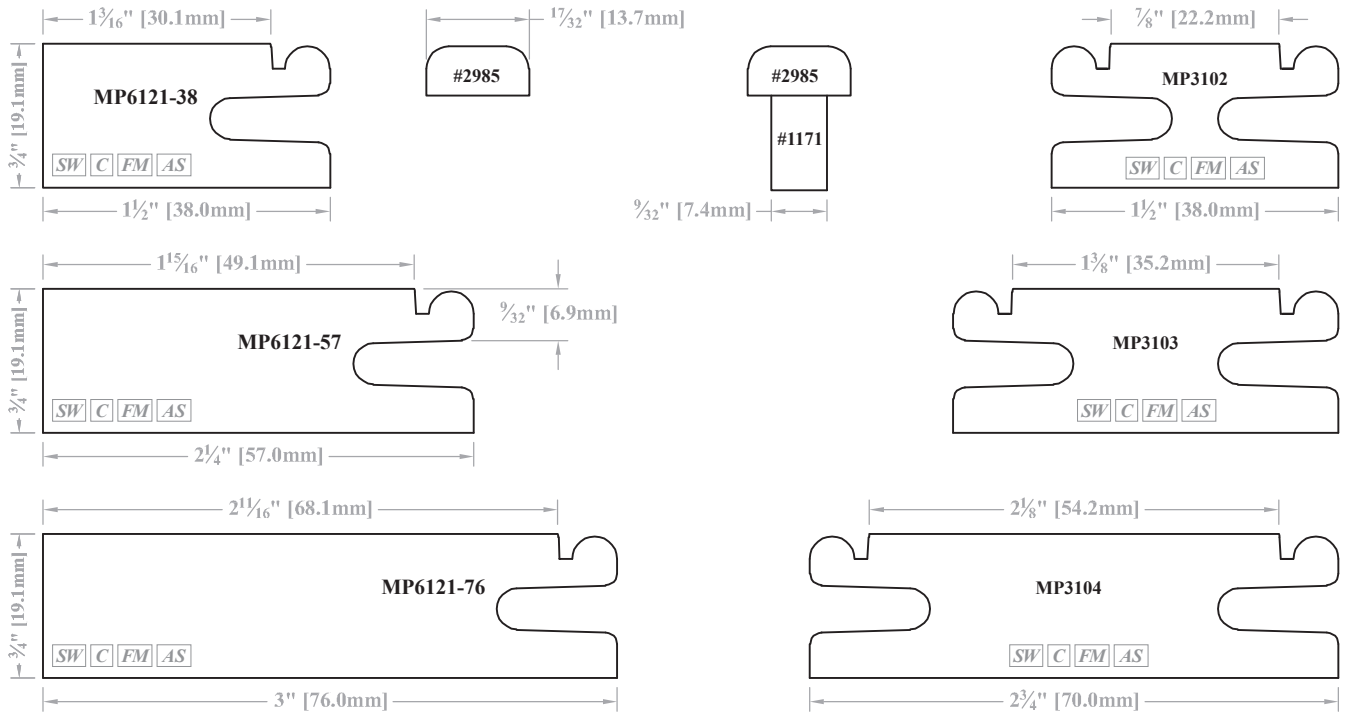

SW = Available in Solid Wood.

FM = Available for French Miter Doors.

C = Available for Convex/Concave products.

AS = Available on Adventure Series Doors.

► For PRICING ► See Section E.9 in our current Wholesale Pricing Catalog.

Mitered Stile & Rail Profiles with Matching Mullion Stock

MP6122 Family

Center Stiles & Rails will look like these profiles.

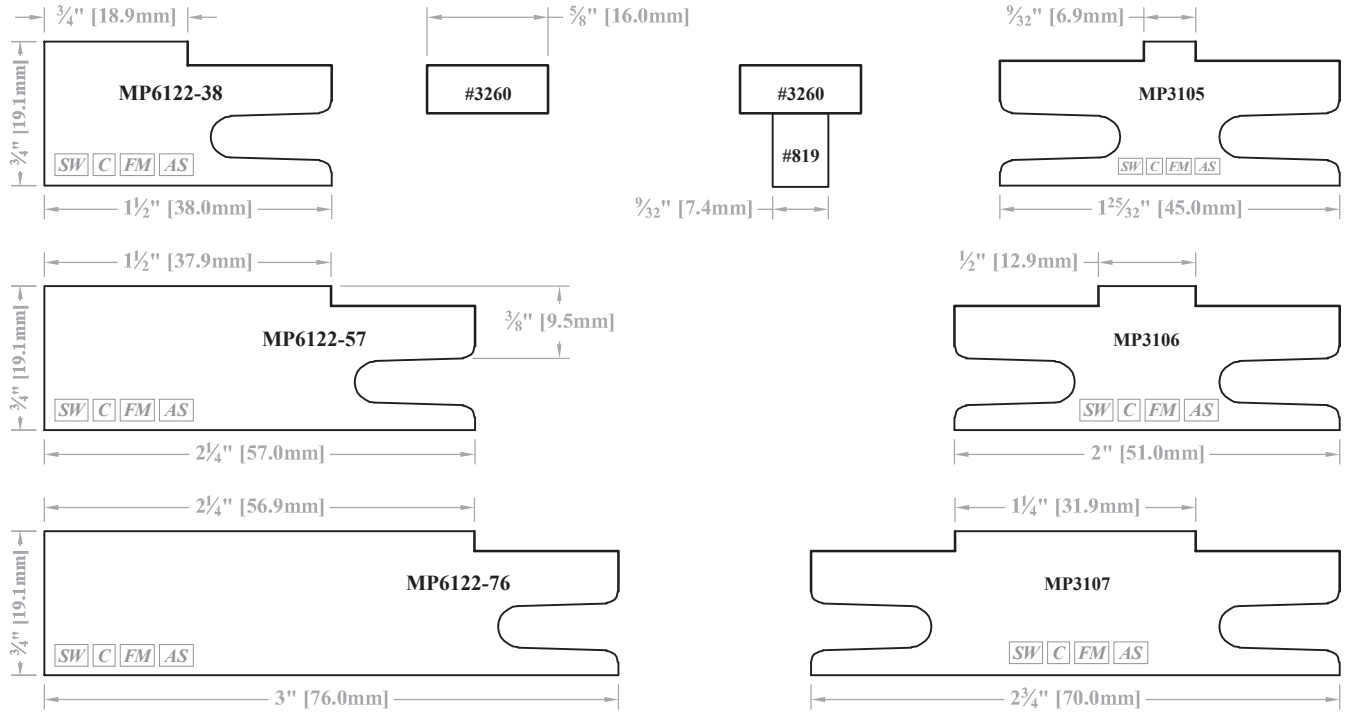

E

SW = Available in Solid Wood. FM = Available for French Miter Doors. C = Available for Convex/Concave products. AS = Available on Adventure Series Doors.

► For PRICING ► See Section E.9 in our current Wholesale Pricing Catalog.

Ordering & Pricing Notes: MP600/MP6000 Series Miter Door & Drawer Front Profiles

Ordering Guidelines

1	Order Forms	Applicable order forms will include spaces to indicate your chosen profiles.
Pricing		
1	Pricing	Please see <i>Section E.9</i> of our current Wholesale Pricing Catalog.

Technical Notes: MP600/MP6000 Series Miter Door & Drawer Front Profiles

Cabinet Door & Drawer Front Options (Chapter B)

1	Mitered Frame or Mullion Doors	All of the mitered profiles shown in this catalog are also available with the GRF profile. When ordering, please indicate whether the door is a frame or mullion. If a mullion, please indicate the lite pattern and number of lites. <i>Not all mitered profiles are available with mullions.</i>
---	--------------------------------	--

Design Options (Chapter G)

1	Radius Corners	The MP600/MP6000 Series Mitered Profiles, which accept additional outside edges may also have radius outside corners. <ul style="list-style-type: none"> • 1½" [38.1mm] wide Mitered Profiles can accept up to a ¾" [19.1mm] radius. • Mitered Profiles 2¼" [57.2mm] to 4½" [114.3mm] can accept up to a 1" [25.4mm] radius. • For more information, please refer to <i>Section G.13</i>.
2	Mitered Stile and Rail Stock (Part #SRP100)	Mitered stile and rail stock is produced and priced the same as Traditional stile and rail stock with an outside edge. <ul style="list-style-type: none"> • Available in 8' [2438.4mm], Random Length and Cut to Length sizes. See <i>Section G.16</i> for additional information and pricing guidelines. • To order please use <i>E•Z Order Form #5 - Moldings and Miscellaneous</i> and Part #SRP100.

Functional Options (Chapter F)

1	1½" [38.1mm] Wide Profiles	Hinge boring is <i>not available</i> for any of the 1½" [38.1mm] wide miter profiles.
---	----------------------------	---

General Information (Chapter A)

1	Ready to Assemble (RTA)	RTA is available as an option.
---	-------------------------	--------------------------------

Material Options

1	Material Options	SW = Profile is available on products made from solid wood.
---	------------------	--

Miscellaneous

1	Center Stile/Rail Construction	Most center stiles & rails will be haunched into the outside stiles & rails creating a mitered joint where they are conjoined. Exceptions will apply where the haunch distance is too small to miter. In these cases, a butt joint will be used (ex: MP612/MP1468).
---	--------------------------------	---

Profile Options (Chapter E)

1	Outside Edge Profiles	MP600/MP6000 mitered profiles require the choice of an outside edge profile. See <i>Sections E.15</i> and <i>E.16</i> . Also available with the ME (Molder Edge) profiles shown at the end of this section. <ul style="list-style-type: none"> • MEs are only available on parts 3" [76.2mm] wide or less.
		D5, D16, D20, D22, D36, D44, D58, D123, D144 and D180 outside edges are <i>not available</i> with any mitered construction. These edge treatments will leave a void in the tenon joint on profiles.
2	Miter Profile Families: MP623, MP624	Center panels will be <i>flush</i> with the face of stiles and rails when using these center panel profiles: <ul style="list-style-type: none"> • PR318-25, PR319-10, PR320-25, PR320-32, PR320-44, PR321-32, PR328-32 or PR329-19. <ul style="list-style-type: none"> ◦ Available in solid wood and raw MDF.
		Center panels will be <i>recessed</i> below the face of the stiles and rails when using these center panel profiles: <ul style="list-style-type: none"> • RVSCP-PR324 Reversed Solid Center Panel (available in solid wood and raw MDF). • ¼" [6.4mm] Flat Panel (available in veneer and raw MDF).
		The MP623 and MP624 families are only compatible with the center panel profiles noted above.
		The MP623 family is only available in ¾" [19.1mm] thickness.
3	Miter Profile Families: MP628, MP661, MP662, MP673, MP680, MP690, MP696, MP6104, MP6112, MP6114	Center panels will be <i>recessed</i> below the face of the stiles and rails when using these center panel profiles: <ul style="list-style-type: none"> • PR318-25, PR319-10, PR320-25, PR320-32, PR320-44, PR321-32, PR328-32, PR329-19, RVSCP-PR324 (Reversed Solid Center Panel) <ul style="list-style-type: none"> ◦ Available in solid wood and raw MDF. • ¼" [6.4mm] Flat Panel <ul style="list-style-type: none"> ◦ Available in veneer and raw MDF.
		The MP628, MP661, MP662, MP673, MP680, MP690, MP696, MP6104, MP6112 and MP6114 families are only compatible with the center panel profile listed above.

Continued on Next Page...

► For PRICING ► See *Section E.9* in our current Wholesale Pricing Catalog.

Technical Notes: MP600/MP6000 Series Miter Door & Drawer Front Profiles ...continued

Profile Options (Chapter E)...continued

3	<p>Miter Profile Families: MP628, MP661, MP662, MP673, MP680, MP690 MP696, MP6104, MP6112, MP6114</p>	<p>Center panels will be <i>recessed</i> below the face of the stiles and rails when using these center panel profiles:</p> <ul style="list-style-type: none"> • PR318-25, PR319-10, PR320-25, PR320-32, PR320-44, PR321-32, PR328-32, PR329-19, RVSCP-PR324 (<i>Reversed Solid Center Panel</i>) <ul style="list-style-type: none"> ◦ Available in solid wood and raw MDF. • ¼" [6.4mm] Flat Panel <ul style="list-style-type: none"> ◦ Available in veneer and raw MDF. <p>The MP628, MP661, MP662, MP673, MP680, MP690, MP696, MP6104, MP6112 and MP6114 families are only compatible with the center panel profile listed above.</p>
4	<p>MP649 Family MP694 Family</p>	<p>Only available with applied molding. Please see SR133 and SR155 in <i>Sections E.1</i> and <i>E.5</i>, as these are exact matches to the MP649 and MP694 and would utilize the same applied moldings.</p> <ul style="list-style-type: none"> • SR133 matches MP649. • SR155 matches MP694.
5	<p>MP660 Family</p>	<p>Designed to accept Applied Molding #1168, #1169 and #3149. Molding must be ordered separately.</p>
6	<p>MP673 Family</p>	<p>Not compatible with ME Outside Edge Profiles.</p>
7	<p>French Miter Construction</p>	<p>EM = Available with French Miter construction. For more information on French Miter construction, please see <i>Section B.7</i>.</p> <p>The MP632, MP635, MP643, MP646, MP648, MP659, MP660, MP666, MP668, MP675, MP681, MP683, MP695, MP6101, MP6102, MP6105, MP6107, MP6108, and MP6116 families can be ordered as French Miter construction when stile and rail widths are 1¾" [44.5mm] or greater.</p> <p>The MP604 and MP605 family can be ordered as French Mitered construction when stile and rail widths are 2" [50.8mm] or greater.</p>
8	<p>Adventure Series</p>	<p>AS = These profile options are available on Adventure Series doors. See <i>Section B7</i> for more information.</p> <p>Center stile/rail profiles MP3092 (for MP691) and MP3093 (for MP692) are only available on Adventure Series doors. Profiles are fixed at the widths shown. For any other widths, please submit your requests to our Customer Support Team.</p>

Sizes / Dimensions

1	<p>Profile Drawings</p>	<p>All stile/rail and mullion stock drawings are shown at full scale.</p>
2	<p>Thickness</p>	<p>Available in ¾" [19.1mm] and 1" [25.4mm] thickness, unless otherwise noted.</p>
3	<p>Minimum Sizes</p>	<p>All mitered door and drawer front minimum sizes are calculated based on 2¼" [57.2mm] wide profiles.</p> <ul style="list-style-type: none"> • If using a 3" [76.2mm] wide profile, please add 1½" [38.1mm] to the published minimum door size. • If using a 1½" [38.1mm] wide profile, deduct 1½" [38.1mm] from the published minimum size.
4	<p>Stile/Rail Width Flexibility</p>	<p>The MP600/MP6000 series accommodates stile/rail width flexibility.</p> <ul style="list-style-type: none"> • Stiles/rails can be ordered in widths from 1½" [38.1mm] to 3" [76.2mm] in ¼" [6.4mm] increments. <ul style="list-style-type: none"> ◦ See individual profile drawings for profile families that may include additional standard sizes. ◦ If wanting to deviate from these standard sizes, see Non-Standard Part Sizes in <i>Section A.5</i> for more information, as additional charges will apply. • The top rail, bottom rail, left stile and right stile must all be the same profile and the same width. <ul style="list-style-type: none"> ◦ See French Miter doors in <i>Section B.7</i> when needing stile widths to vary from rail widths. • When modifying the width of an MP600/MP6000 miter profile, we will take the next smallest standard size profile in that family and add to it. <ul style="list-style-type: none"> ◦ Eg: If you order MP634 at 2½"W, we will take the MP634-57 and add ¼" to the outside edge, leaving the profile area unaffected. ◦ For MP642 (57, 76, 89) and MP645 (57, 76, 89) we will maintain the 1½" dimension as shown in the drawings, and add width to the flat portion towards the inside edge. • Center stiles and center rails usually cannot vary from the widths shown in the catalog. <ul style="list-style-type: none"> ◦ In cases where they can be varied, additional charges may apply.

Stile & Rail - Mitered Mortise & Tenon Joinery - MP600/MP6000 Series - END











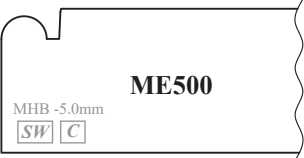
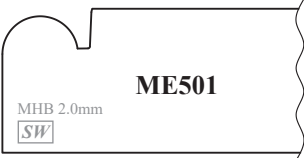
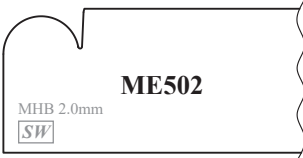
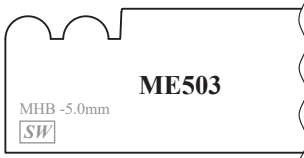
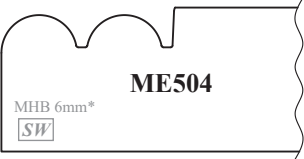
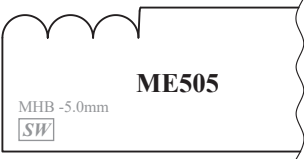
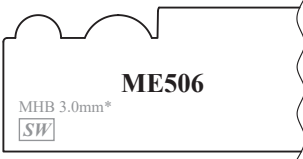

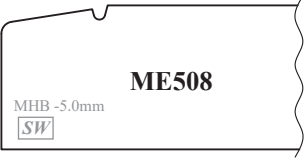
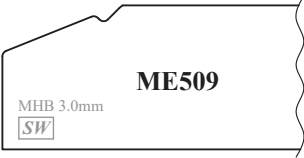
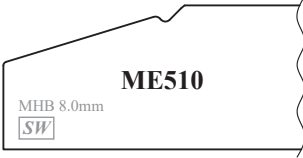
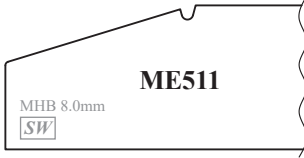
► For PRICING ► See Section E.9 in our current Wholesale Pricing Catalog.

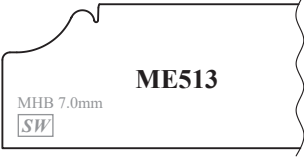
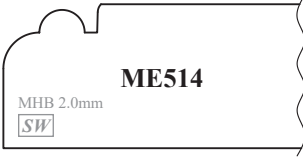
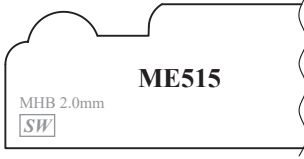
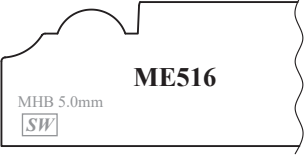
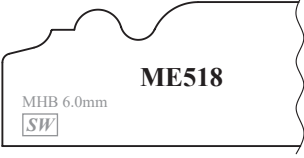
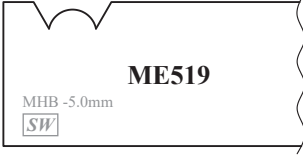
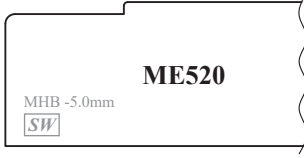
Profile Options

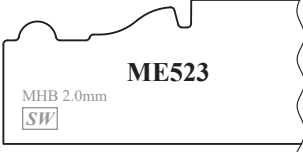
Outside Edge - Molder Edges (ME) for MP600 /MP6000 Series

The **MP600/MP6000** series of mitered profiles shown in this section (*E.9*) of the catalog require the selection of an outside edge profile.

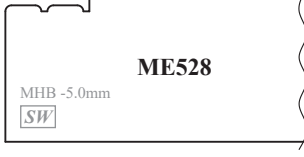
- You may choose from the **Molder Edge (ME)** profile options shown below. Molder Edges are only available with the **MP600/MP6000** series of mitered stile and rail profiles (*not available with "Traditional" joinery options*).
- When not choosing one of these Molder Edge options, **MP600/MP6000s** are available with Outside Edge profiles from *Sections E.15 & E.16*, with the exception of some applied molding edges that are only available on 5/8" [16mm] thick materials, and others that may expose the miter tenon.
- For restrictions when combining **MP600/MP6000** miter profiles with **Molder Edges (ME)**, please see the **Molder Edge (ME)** compatibility chart on our website: **Resources / Technical Information**.

 ME500 MHB -5.0mm [SW] [C]	 ME501 MHB 2.0mm [SW]	 ME502 MHB 2.0mm [SW]	 ME503 MHB -5.0mm [SW]
 ME504 MHB 6mm* [SW]	 ME505 MHB -5.0mm [SW]	 ME506 MHB 3.0mm* [SW]	 ME507 MHB -5.0mm [SW]
 ME508 MHB -5.0mm [SW]	 ME509 MHB 3.0mm [SW]	 ME510 MHB 8.0mm [SW]	 ME511 MHB 8.0mm [SW]
 ME512 MHB 2.0mm [SW] [C]	 ME513 MHB 7.0mm [SW]	 ME514 MHB 2.0mm [SW]	 ME515 MHB 2.0mm [SW]
 ME516 MHB 5.0mm [SW]	 ME518 MHB 6.0mm [SW]	 ME519 MHB -5.0mm [SW]	 ME520 MHB -5.0mm [SW]
 ME521 MHB -5.0mm [SW]	 ME522 MHB -5.0mm [SW]	 ME523 MHB 2.0mm [SW]	 ME524 MHB -5.0mm [SW]
 ME525 MHB -5.0mm [SW]	 ME526 MHB -5.0mm [SW]	 ME527 MHB -5.0mm [SW]	 ME528 MHB -5.0mm [SW]
 ME529 MHB -5.0mm [SW]	 ME530 MHB -5.0mm [SW]		

*See Compatibility Chart for details.

[SW] = Available in Solid Wood.

[FM] = Available for French Miter Doors.

[C] = Available for Convex/Concave products.

[AS] = Available on Adventure Series Doors.



Mitered Stile & Rail Profiles with Matching Mullion Stock

- The **MP700** series of profiles are fully molded and do not accommodate stile and rail width flexibility.
- Available on Mitered door styles from **Section B.5** and **B.6**.
- As a fully molded profile, there is no need to choose an outside edge profile.
- See **Technical Notes** at the end of this section for more information on **MP700** profiles.

The following symbols and abbreviations may appear on profile drawings in this section and indicate the following:

- **[SW]** Profile available on products made from solid wood only.
- **[C]** Profile available on convex or concave products.
- **MHB** Minimum Hinge Bore setback calculated at 12.7mm deep. See **Technical Notes** at the end of this section for Functional Options.

MP700 profiles shown are also available as a Frame or Mullion door with the **GRF** profile. Profile drawings are shown with matching mullion stock where available. See **Section B.12** and the **Technical Notes** at the end of this section for more information.

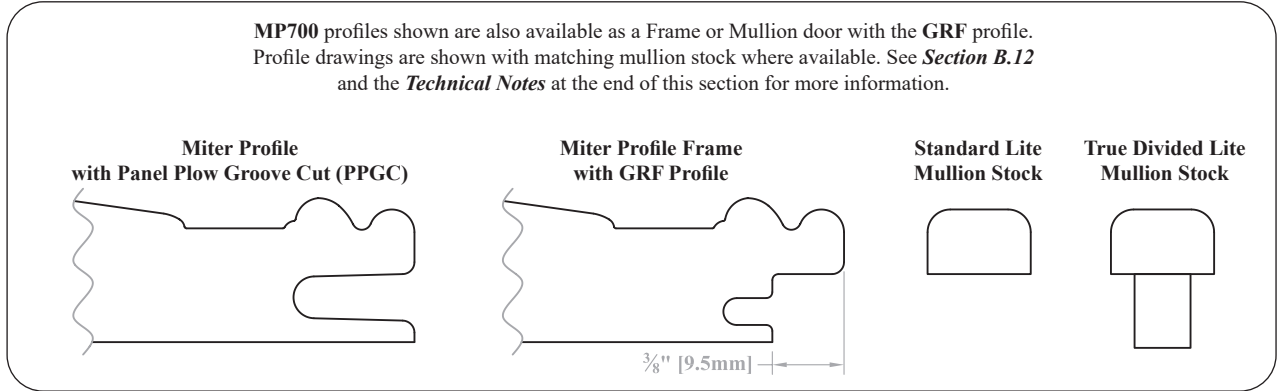

MP701 Family

Center Stiles & Rails will look like these profiles.

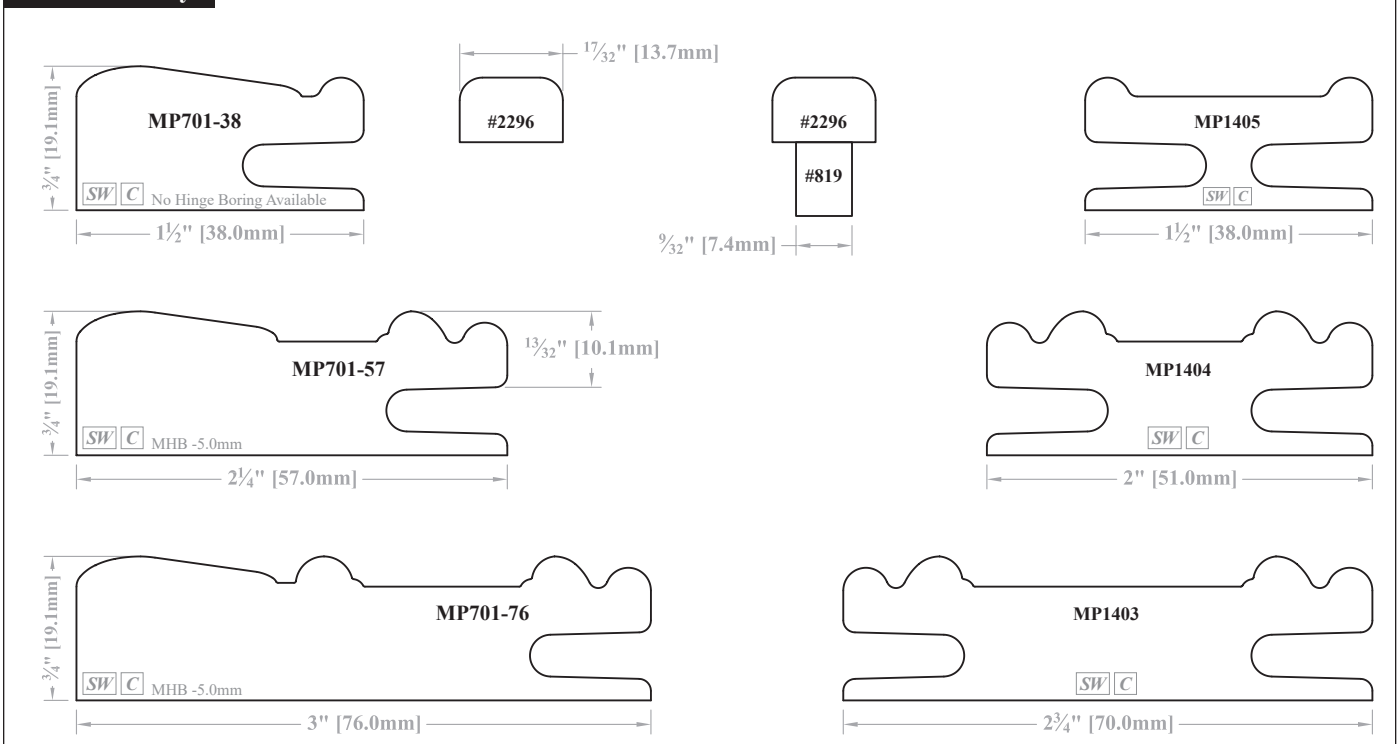

[SW] = Available in Solid Wood.

[C] = Available for Convex/Concave products.

MHB = Minimum Hinge Bore setback calculated at 12.7mm deep.

► For PRICING ► See Section E.10 in our current Wholesale Pricing Catalog.

Profile Options

Stile & Rail - Mitered Mortise & Tenon Joinery - MP700 Series

Mitered Stile & Rail Profiles with Matching Mullion Stock

MP702 Family

Center Stiles & Rails will look like these profiles.

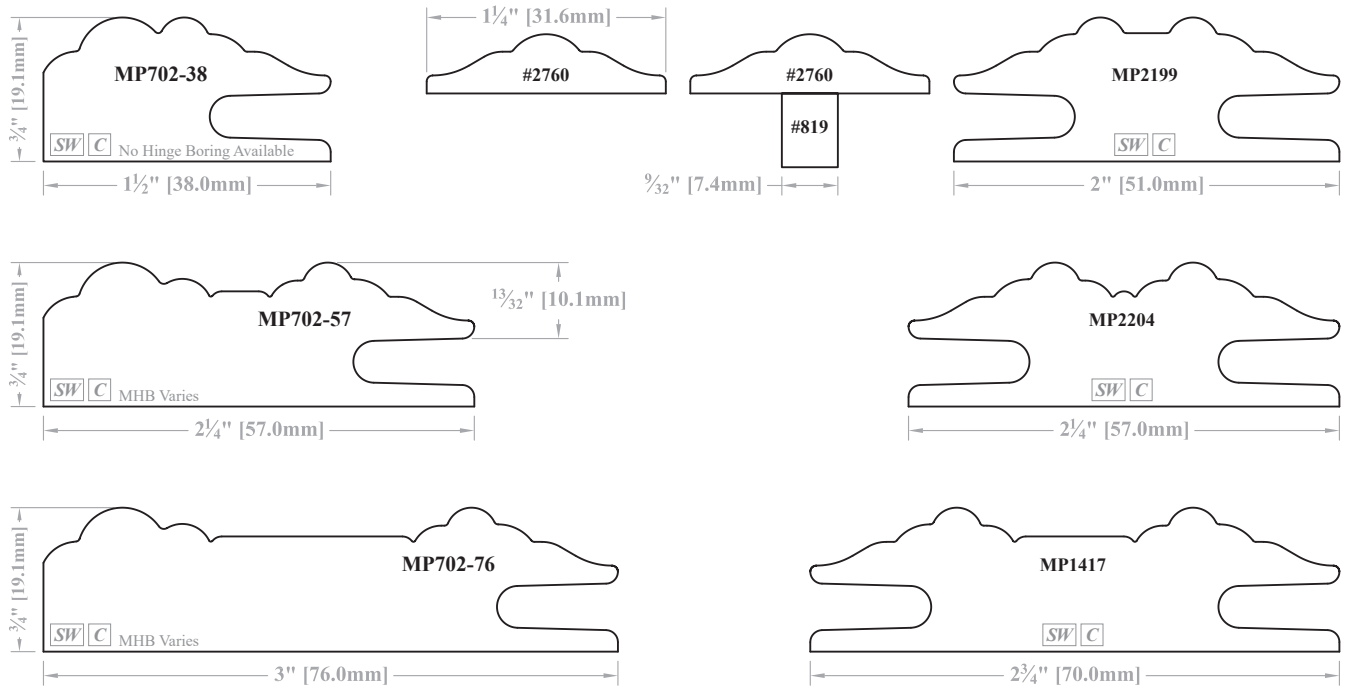

MP703 Family

Center Stiles & Rails will look like these profiles.

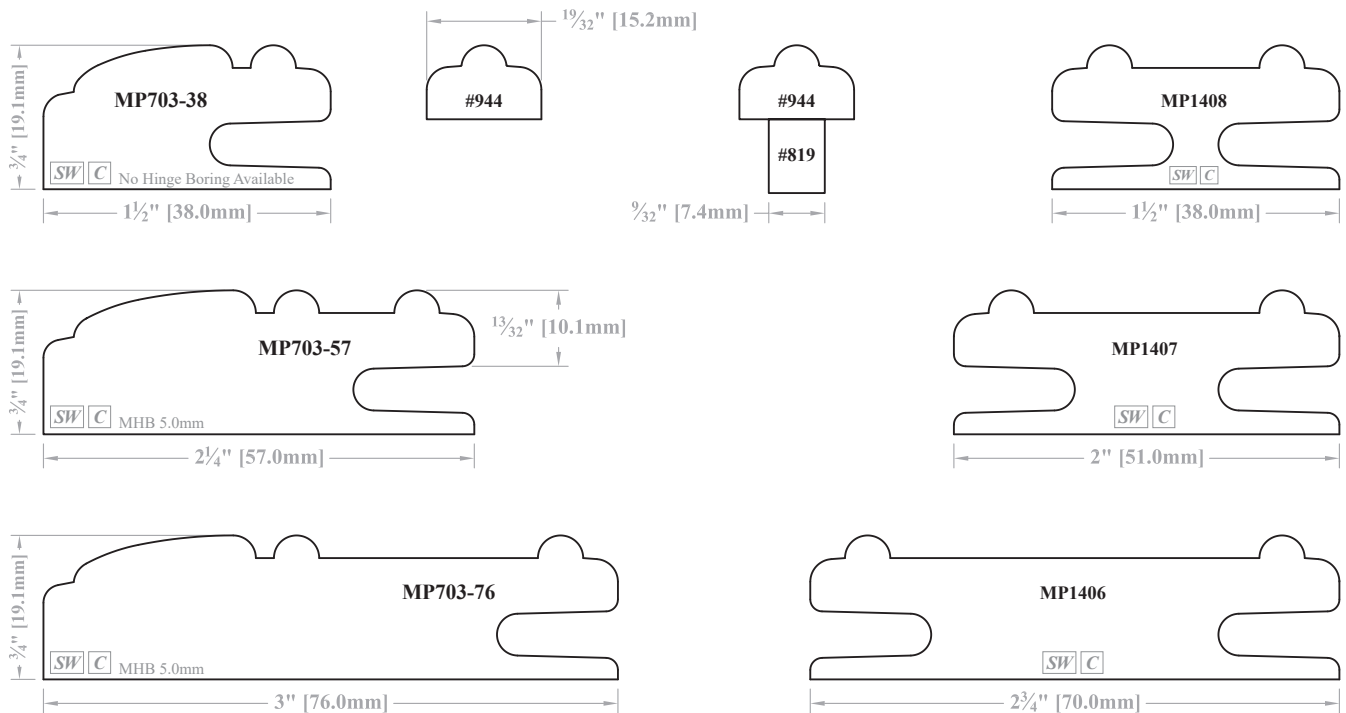

[SW] = Available in Solid Wood.

[C] = Available for Convex/Concave products.

MHB = Minimum Hinge Bore setback calculated at 12.7mm deep.

► For PRICING ► See Section E.10 in our current Wholesale Pricing Catalog.

Mitered Stile & Rail Profiles with Matching Mullion Stock

MP704 Family

Center Stiles & Rails will look like these profiles.

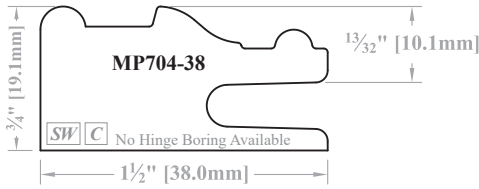

Matching Mullion Stock is not available for MP704-38 and MP1410.

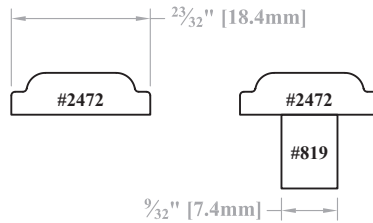
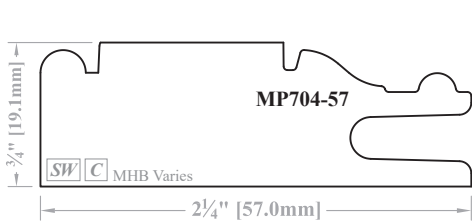
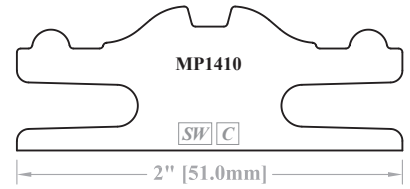

MP704-57 uses MP1409 for center stiles & rails as shown below.

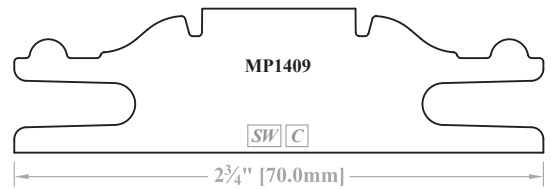
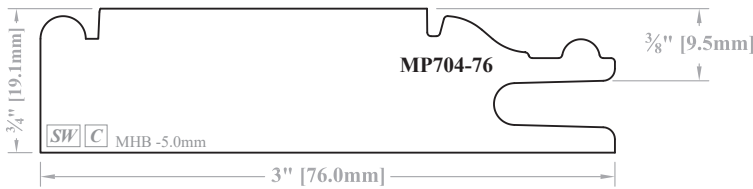

MP705 Family

Center Stiles & Rails will look like these profiles.

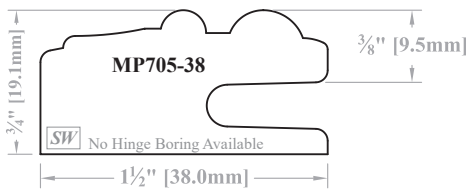

Matching Mullion Stock is not available for MP705-38 and MP1413.

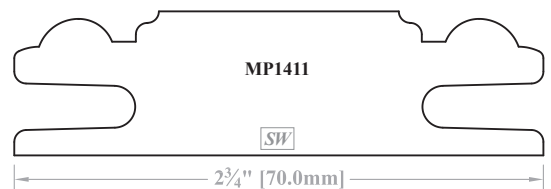
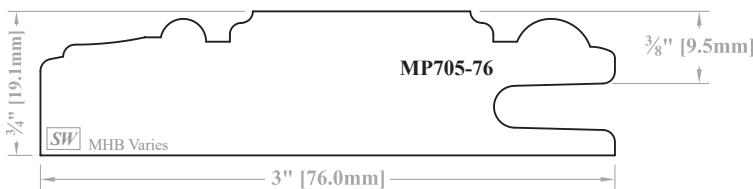
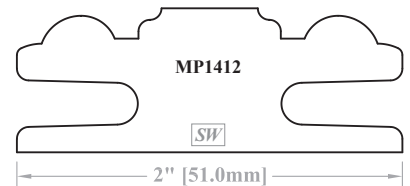
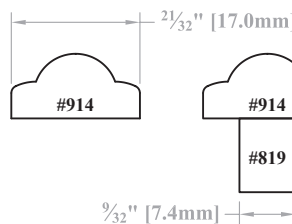
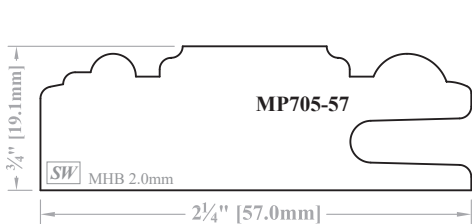
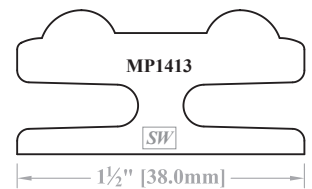

[SW] = Available in Solid Wood.

[C] = Available for Convex/Concave products.

MHB = Minimum Hinge Bore setback calculated at 12.7mm deep.

► For PRICING ► See Section E.10 in our current Wholesale Pricing Catalog.

Profile Options

Stile & Rail - Mitered Mortise & Tenon Joinery - MP700 Series

Mitered Stile & Rail Profiles with Matching Mullion Stock

MP708 Family

Center Stiles & Rails will look like these profiles.

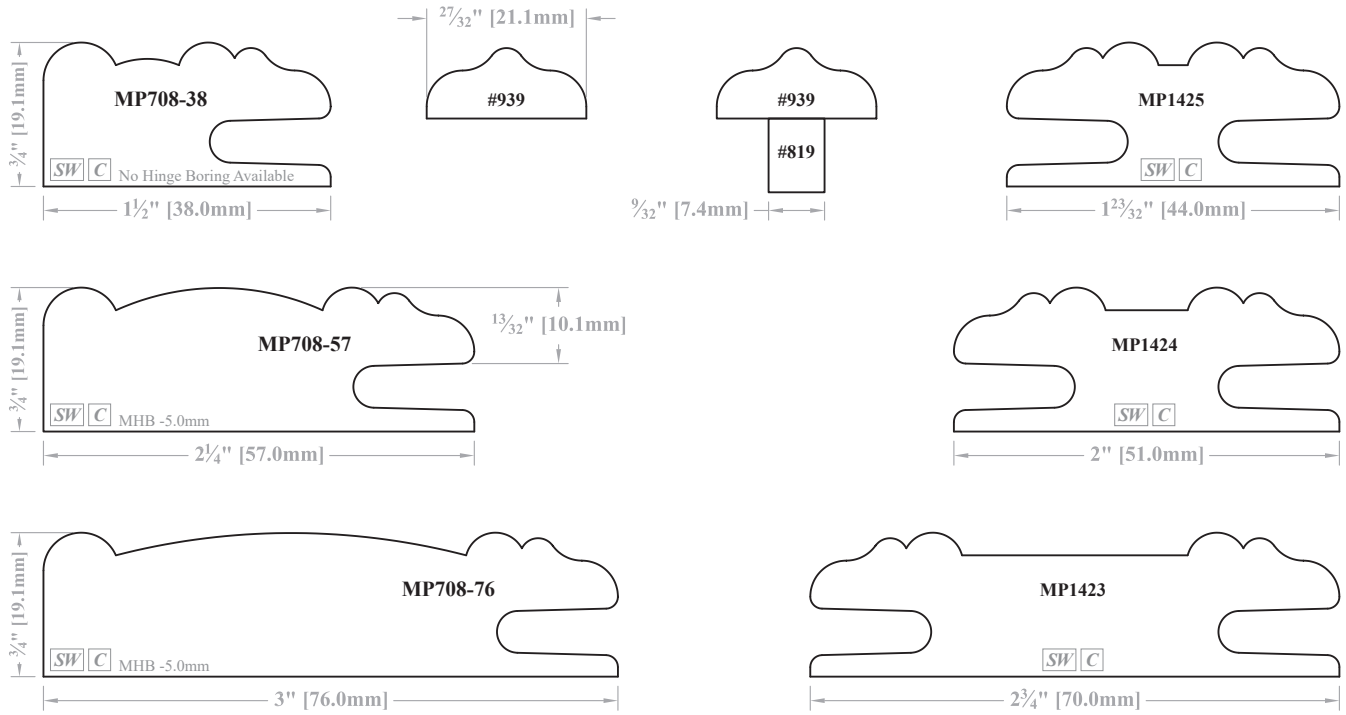

MP709 Family

Center Stiles & Rails will look like these profiles.

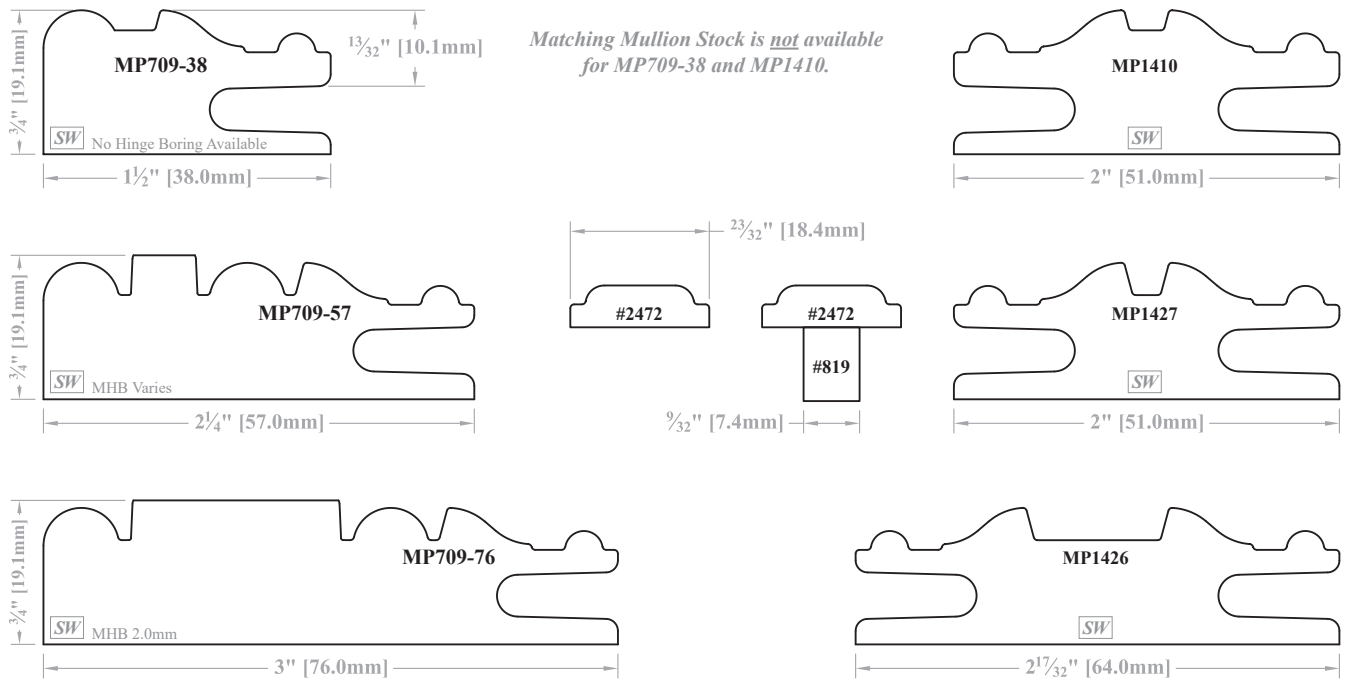

SW = Available in Solid Wood.

C = Available for Convex/Concave products.

MHB = Minimum Hinge Bore setback calculated at 12.7mm deep.

► For PRICING ► See Section E.10 in our current Wholesale Pricing Catalog.

Mitered Stile & Rail Profiles with Matching Mullion Stock

MP710 Family

Center Stiles & Rails will look like these profiles.

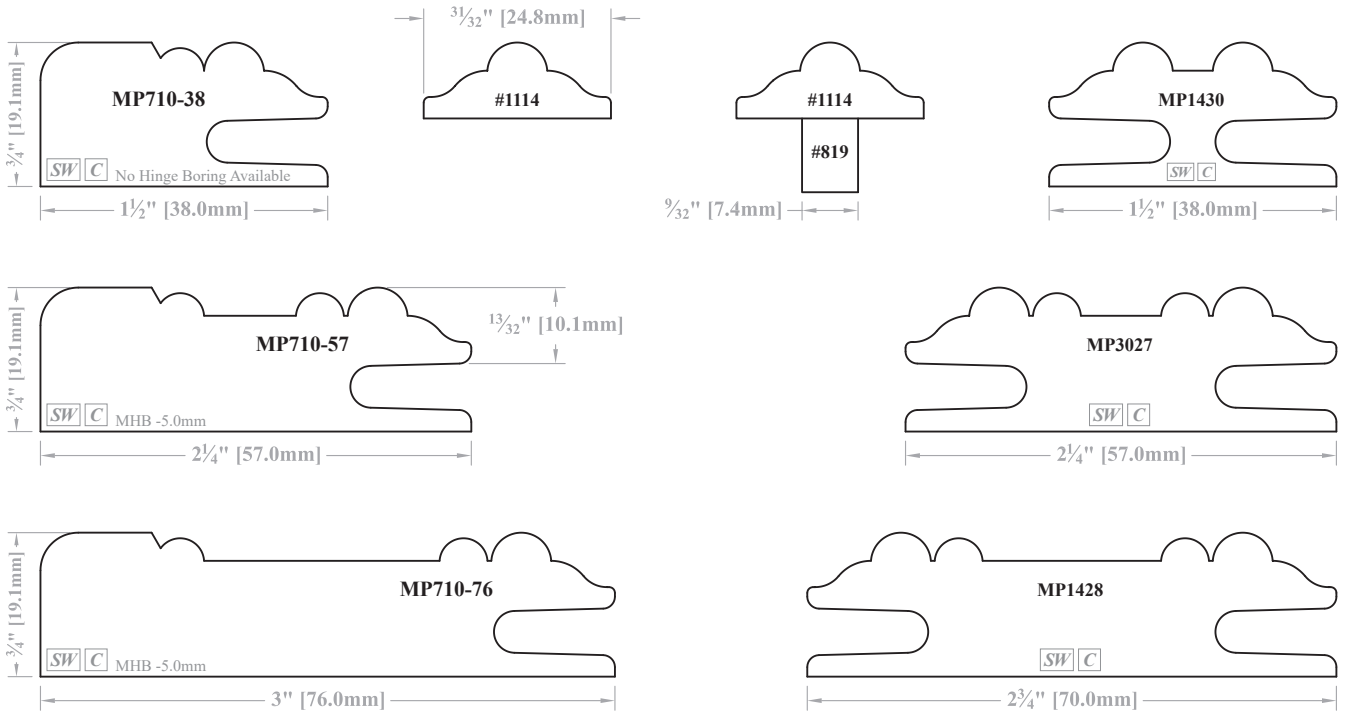

MP715 Family

Center Stiles & Rails will look like these profiles.

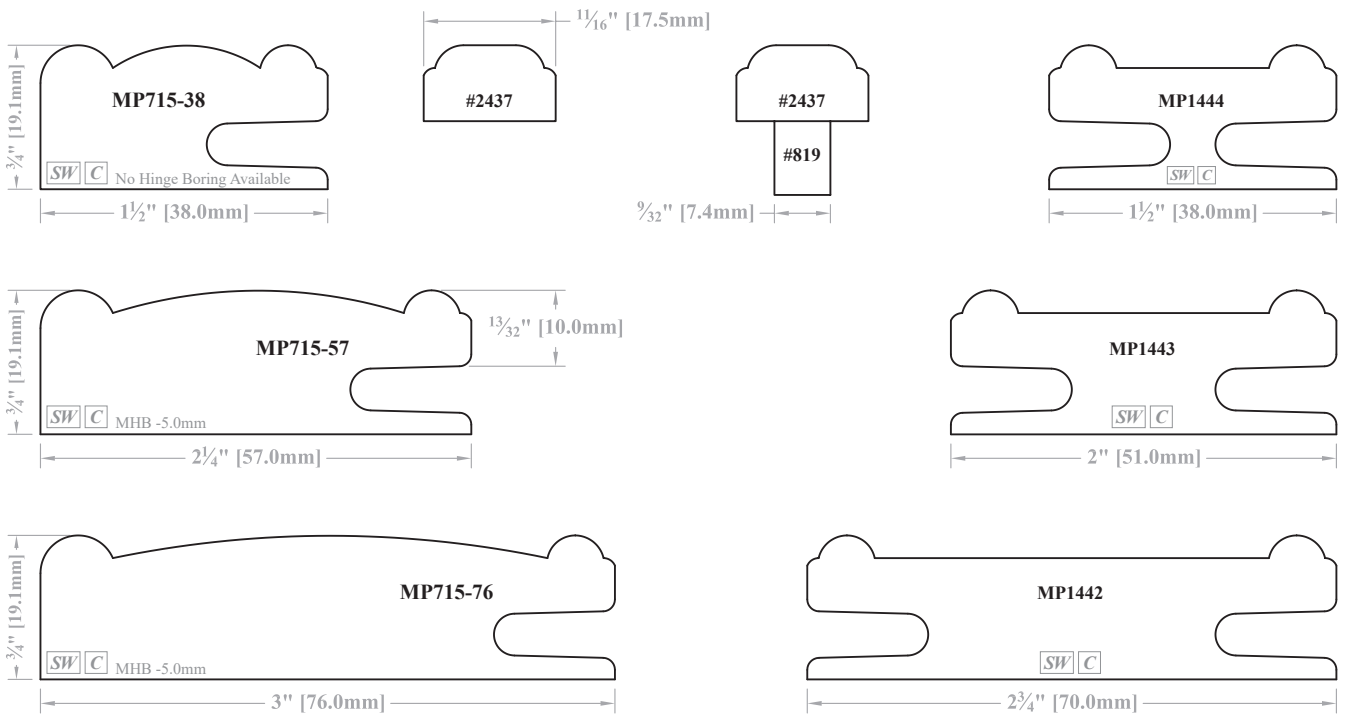

SW = Available in Solid Wood.

C = Available for Convex/Concave products.

MHB = Minimum Hinge Bore setback calculated at 12.7mm deep.

► For PRICING ► See Section E.10 in our current Wholesale Pricing Catalog.

Profile Options

Stile & Rail - Mitered Mortise & Tenon Joinery - MP700 Series

Mitered Stile & Rail Profiles with Matching Mullion Stock

MP716 Family

Center Stiles & Rails will look like these profiles.

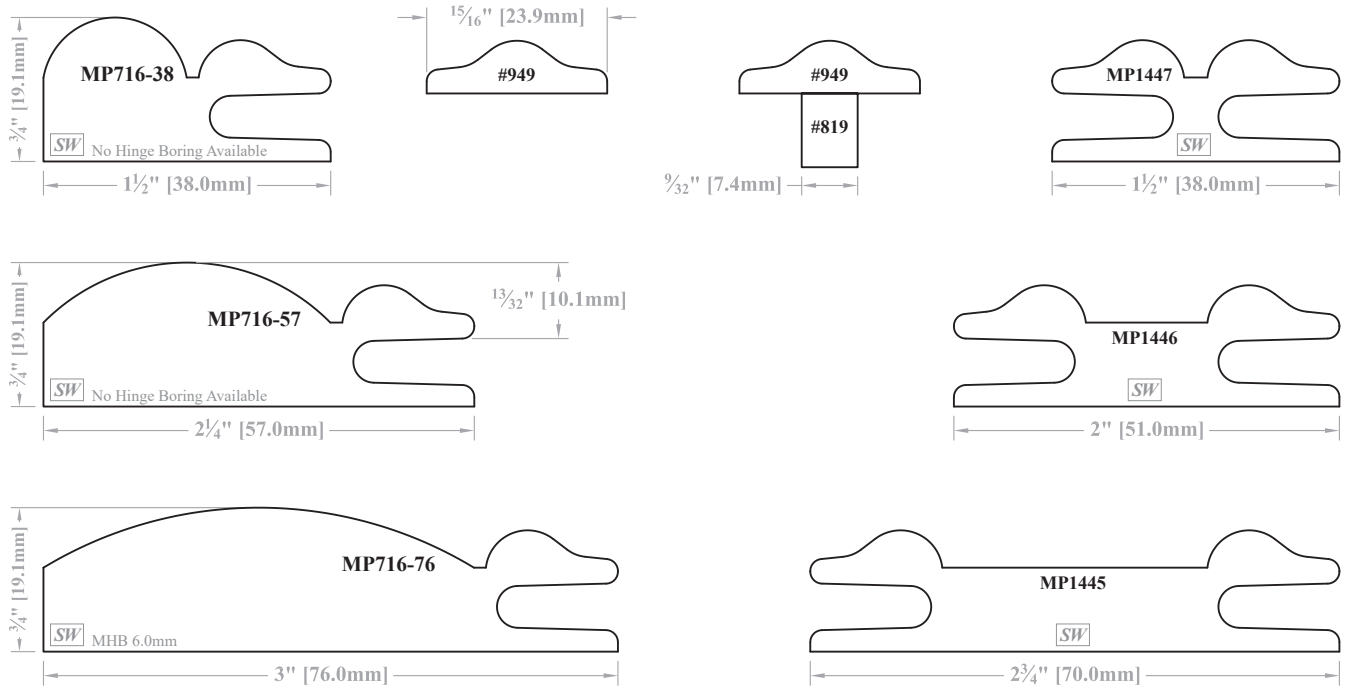

MP717 Family

Center Stiles & Rails will look like these profiles.

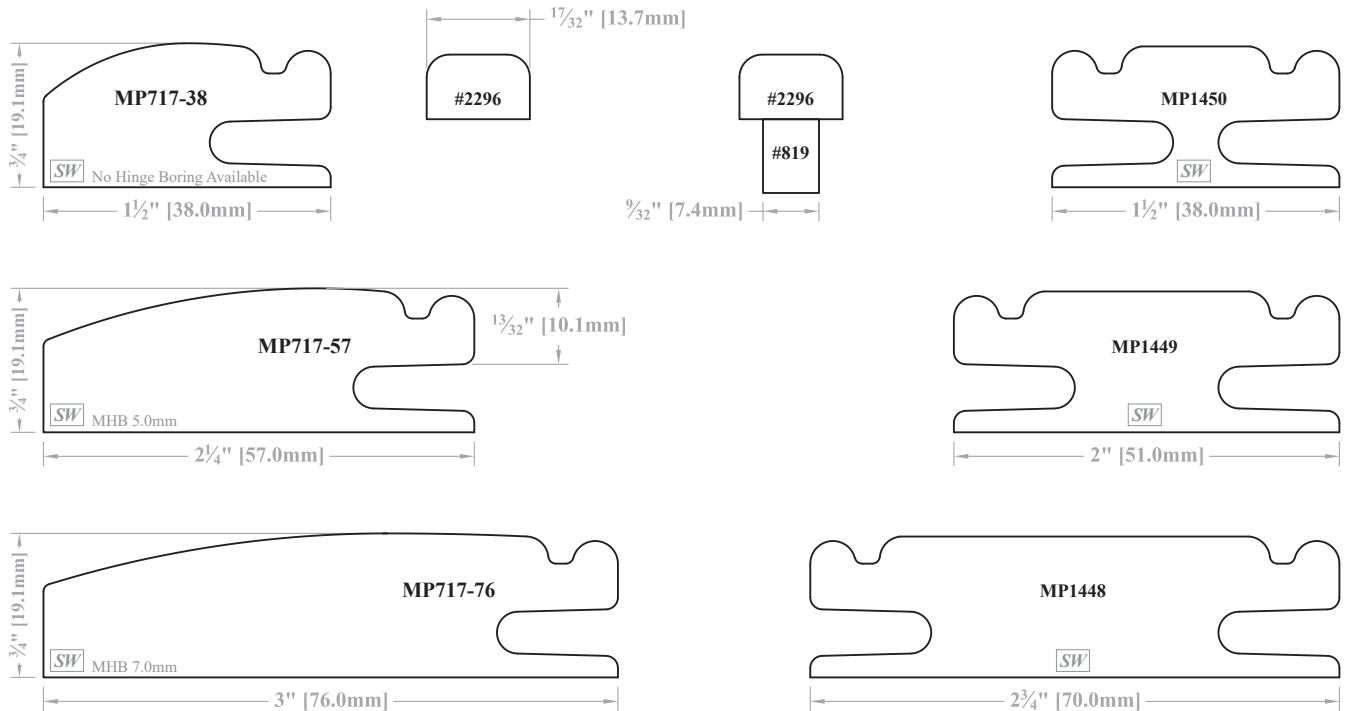

SW = Available in Solid Wood.

C = Available for Convex/Concave products.

MHB = Minimum Hinge Bore setback calculated at 12.7mm deep.

► For PRICING ► See Section E.10 in our current Wholesale Pricing Catalog.

Mitered Stile & Rail Profiles with Matching Mullion Stock

MP718 Family

Center Stiles & Rails will look like these profiles.

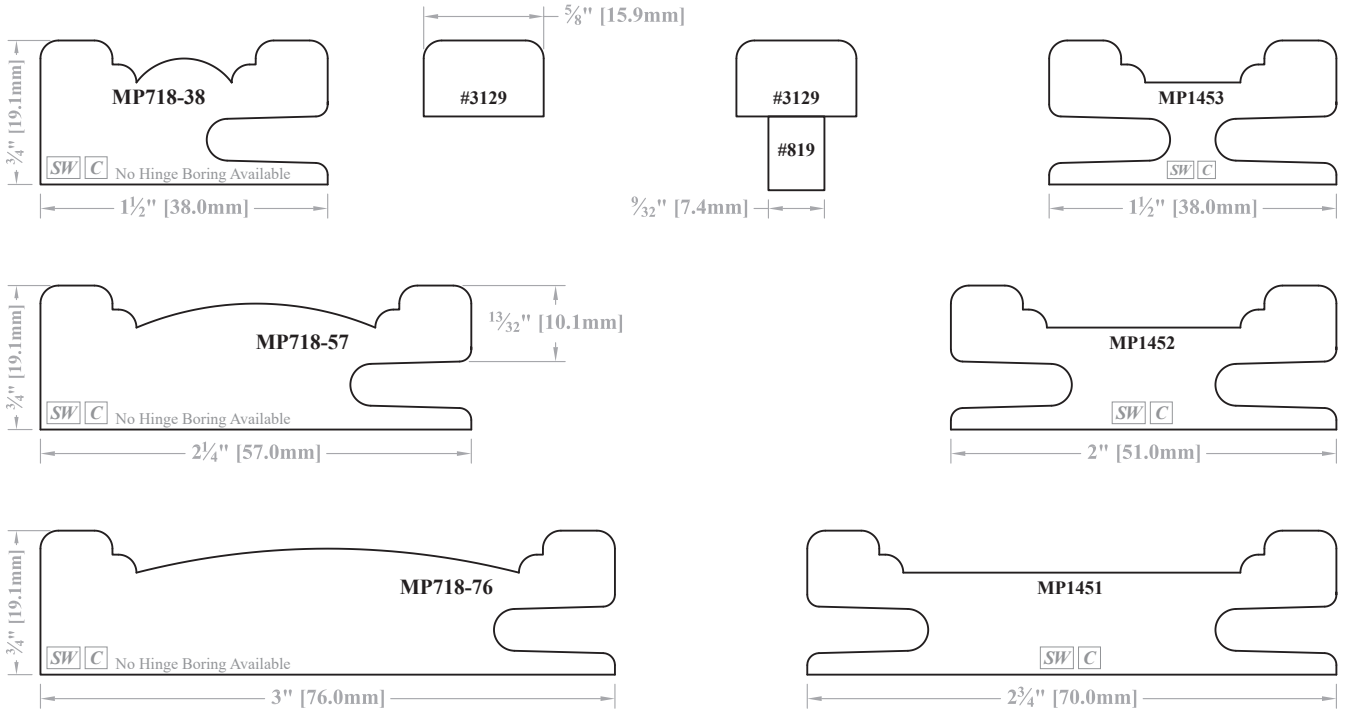

MP719 Family

Center Stiles & Rails will look like these profiles.

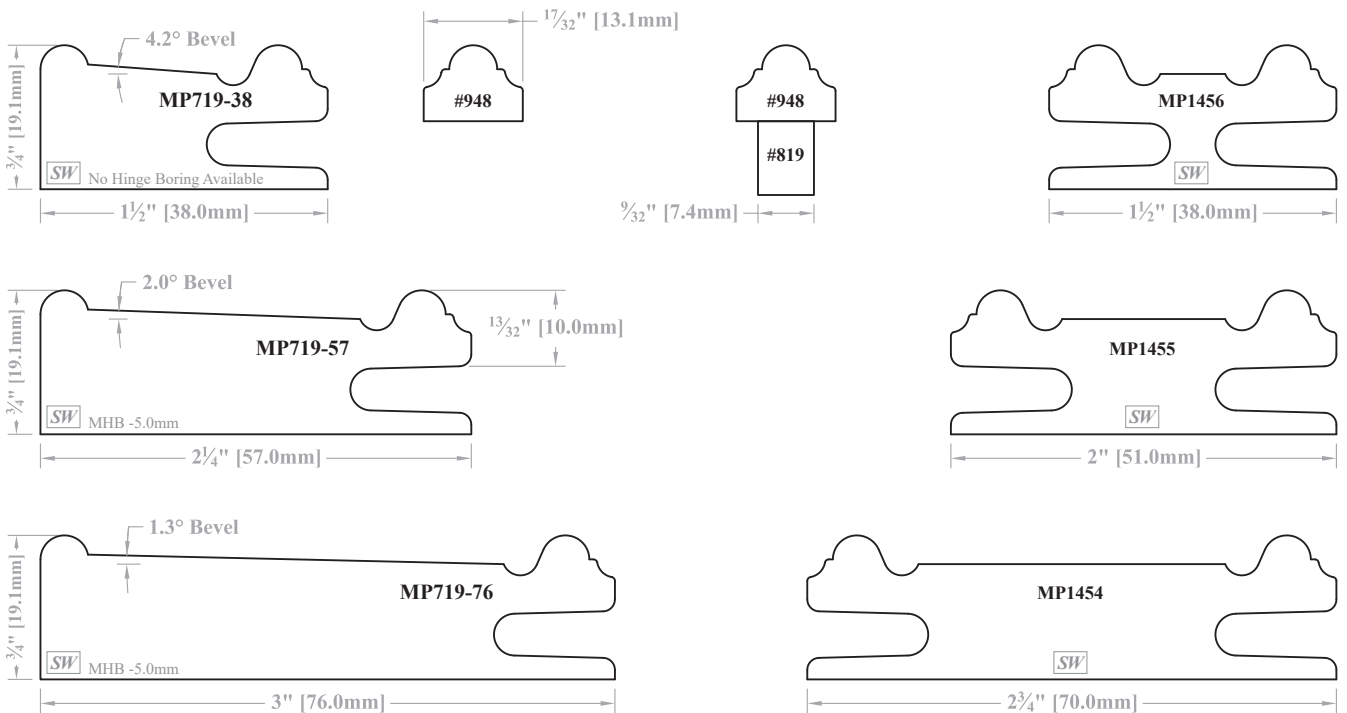

SW = Available in Solid Wood.

C = Available for Convex/Concave products.

MHB = Minimum Hinge Bore setback calculated at 12.7mm deep.

► For PRICING ► See Section E.10 in our current Wholesale Pricing Catalog.

Profile Options

Stile & Rail - Mitered Mortise & Tenon Joinery - MP700 Series

Mitered Stile & Rail Profiles with Matching Mullion Stock

MP720 Family

Center Stiles & Rails will look like these profiles.

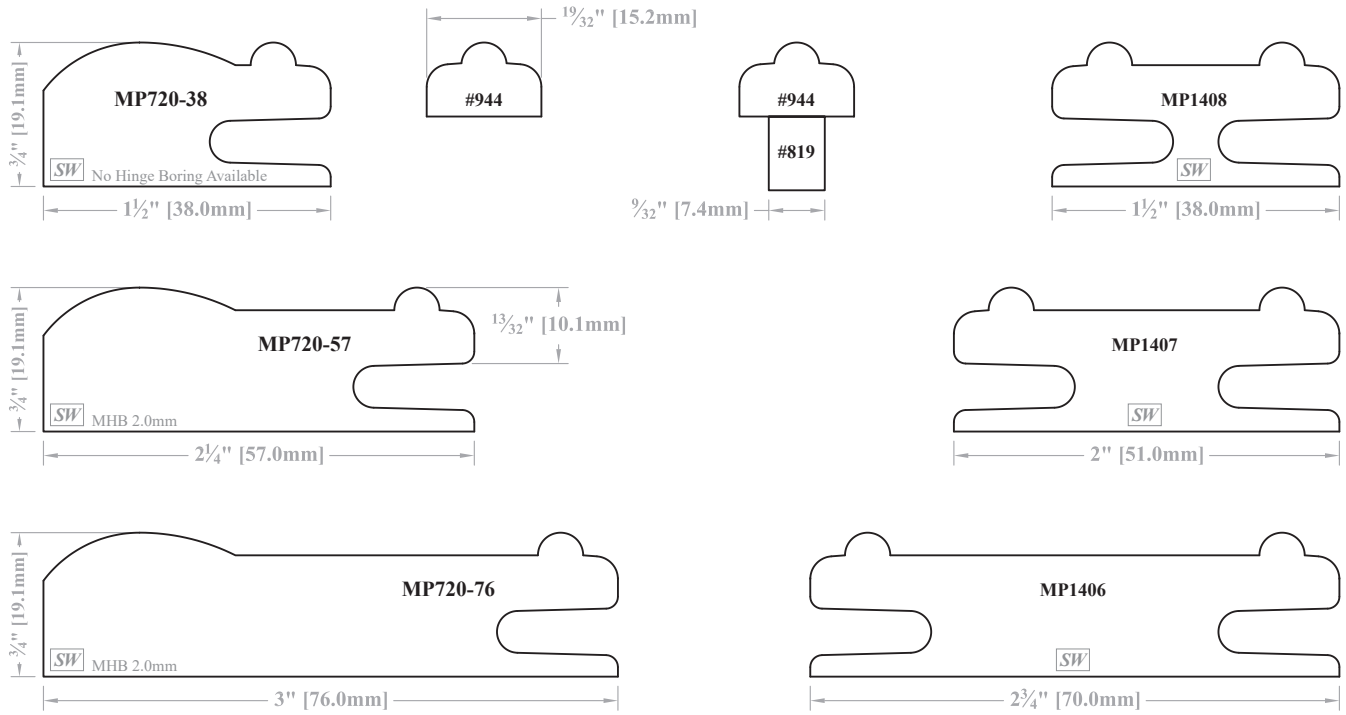

MP722 Family

Center Stiles & Rails will look like these profiles.

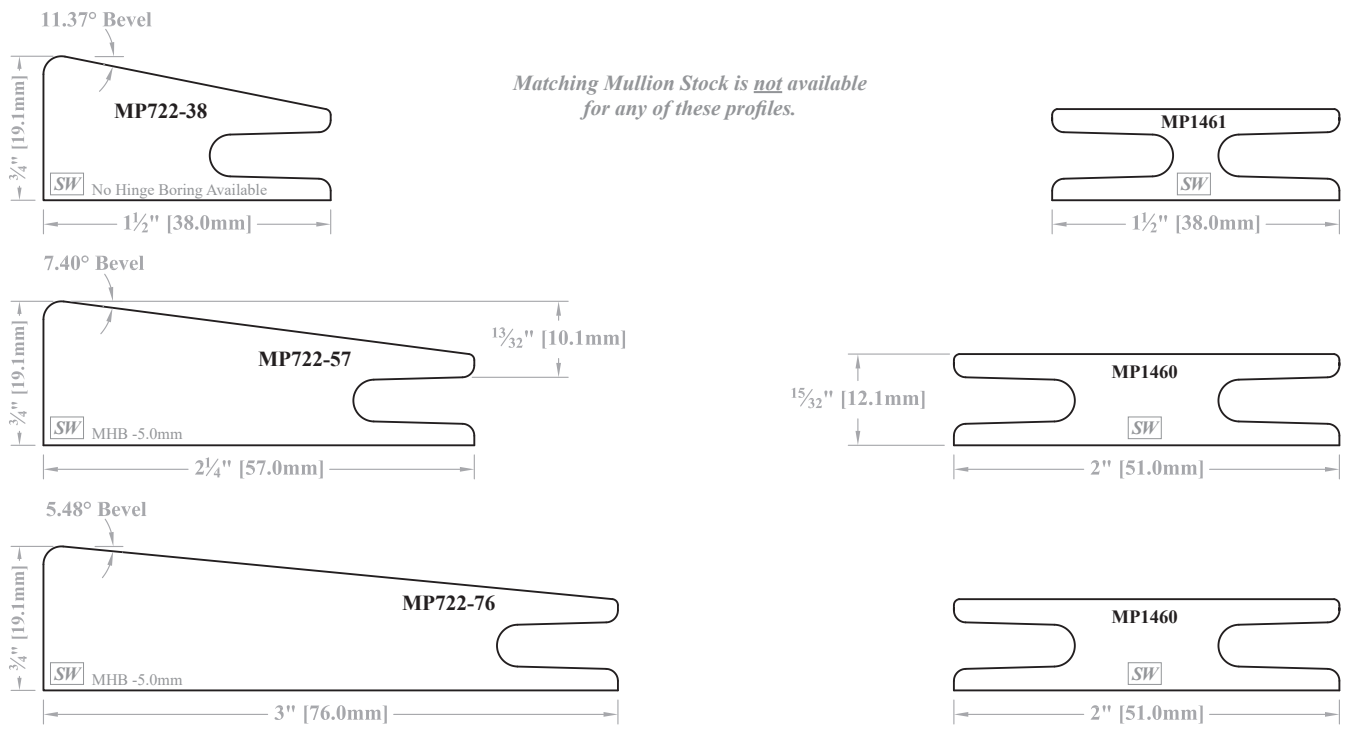

Matching Mullion Stock is not available for any of these profiles.

► For PRICING ► See Section E.10 in our current Wholesale Pricing Catalog.

Mitered Stile & Rail Profiles with Matching Mullion Stock

MP723 Family

Center Stiles & Rails will look like these profiles.

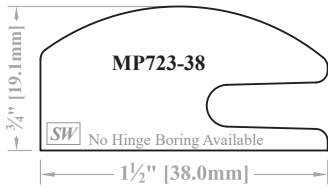

Matching Mullion Stock is not available for any of these profiles.

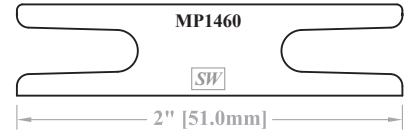
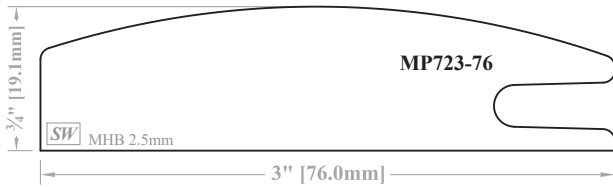
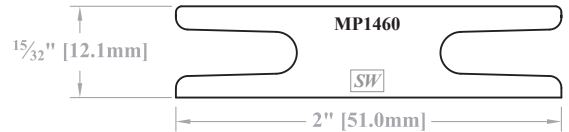
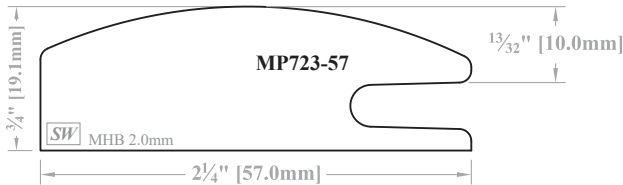
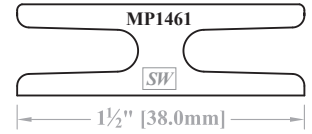

MP733 Family

Center Stiles & Rails will look like these profiles.

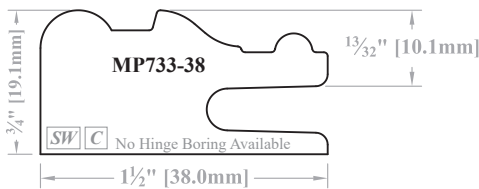

Matching Mullion Stock is not available for MP733-38 and MP1410.

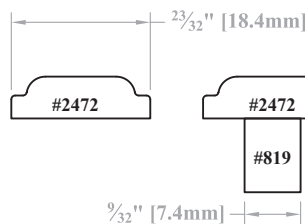
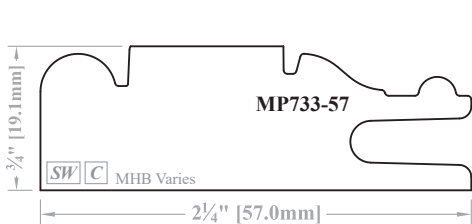
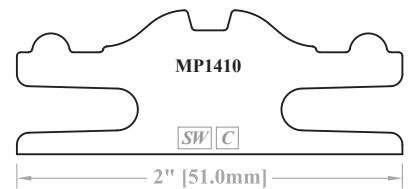

MP733-57 uses MP1409 for center stiles & rails as shown below.

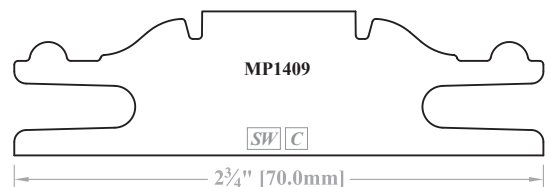
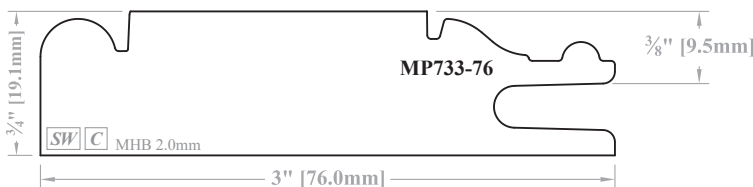

[SW] = Available in Solid Wood.

[C] = Available for Convex/Concave products.

MHB = Minimum Hinge Bore setback calculated at 12.7mm deep.

► For PRICING ► See Section E.10 in our current Wholesale Pricing Catalog.

Profile Options

Stile & Rail - Mitered Mortise & Tenon Joinery - MP700 Series

Mitered Stile & Rail Profiles with Matching Mullion Stock

MP734 Family

Center Stiles & Rails will look like these profiles.

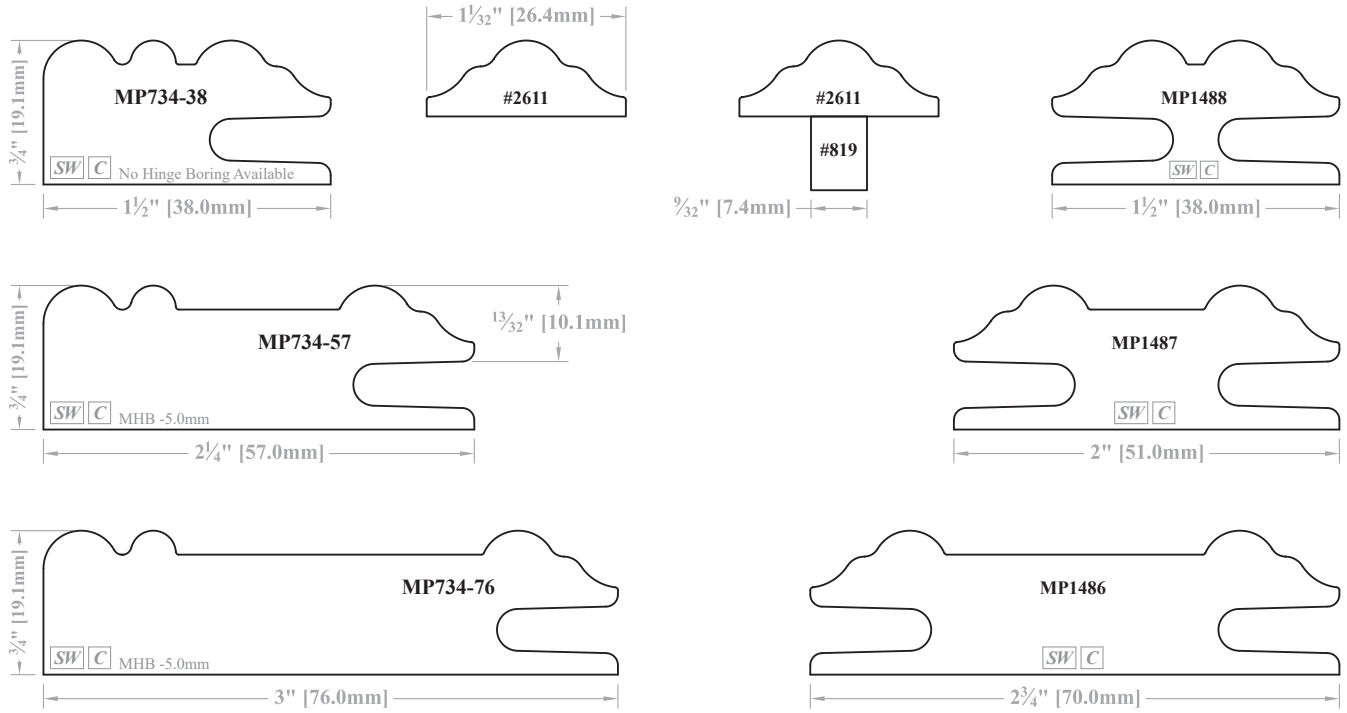

MP735 Family

See Profile Options notes in Section B.12 for alternative mullion.

Center Stiles & Rails will look like these profiles.

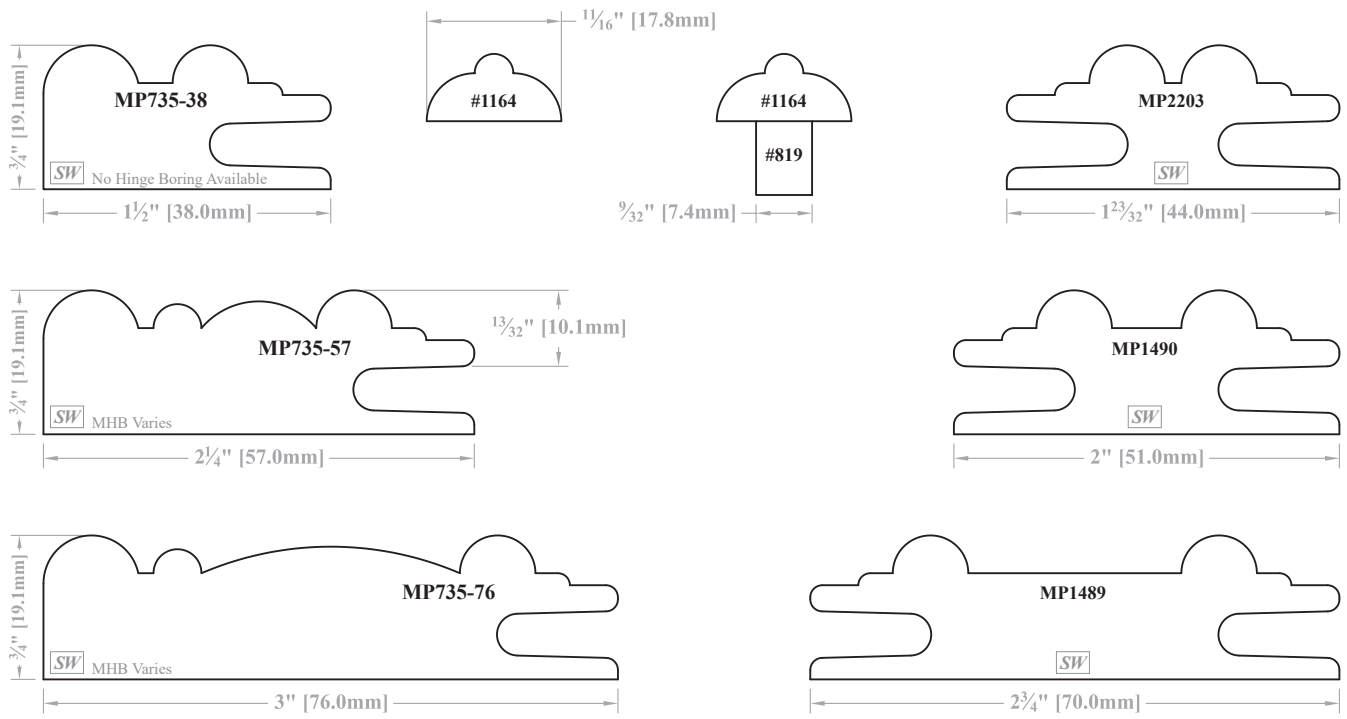

SW = Available in Solid Wood.

C = Available for Convex/Concave products.

MHB = Minimum Hinge Bore setback calculated at 12.7mm deep.

► For PRICING ► See Section E.10 in our current Wholesale Pricing Catalog.

Mitered Stile & Rail Profiles with Matching Mullion Stock

MP738 Family

Center Stiles & Rails will look like these profiles.

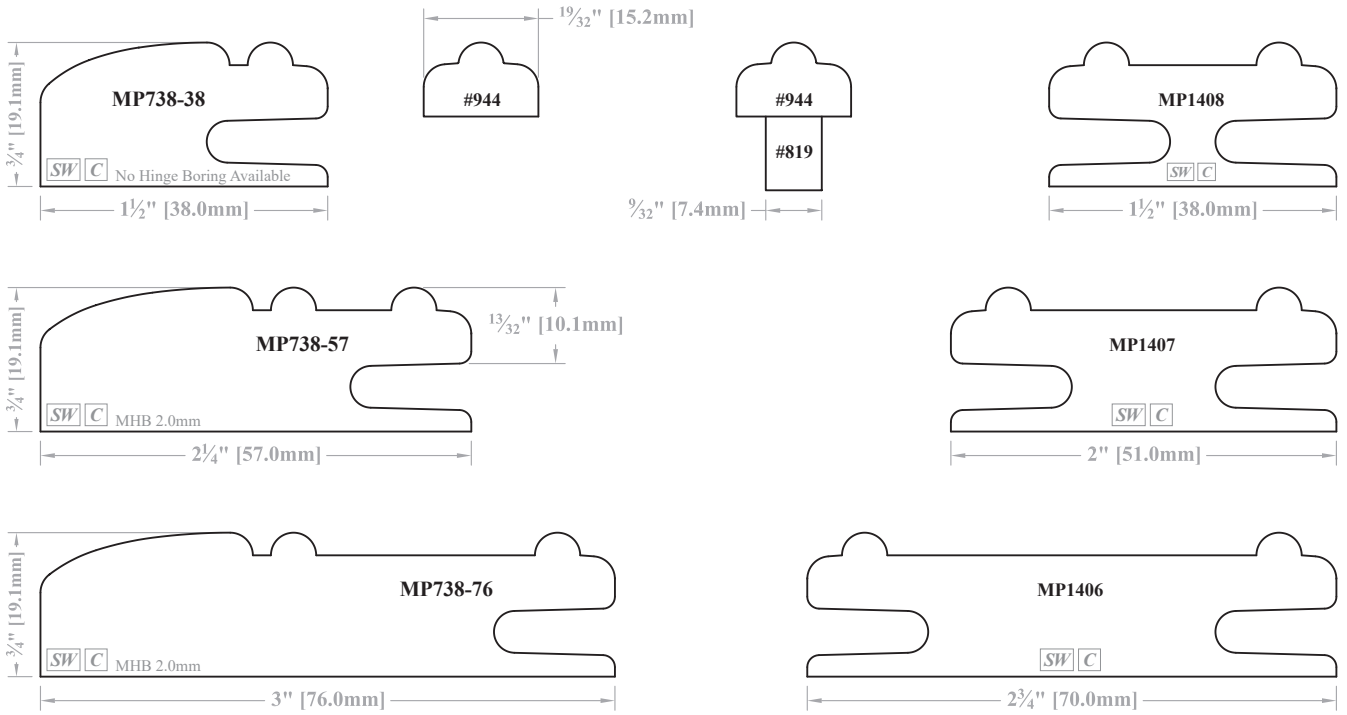

MP740 Family

Center Stiles & Rails will look like these profiles.

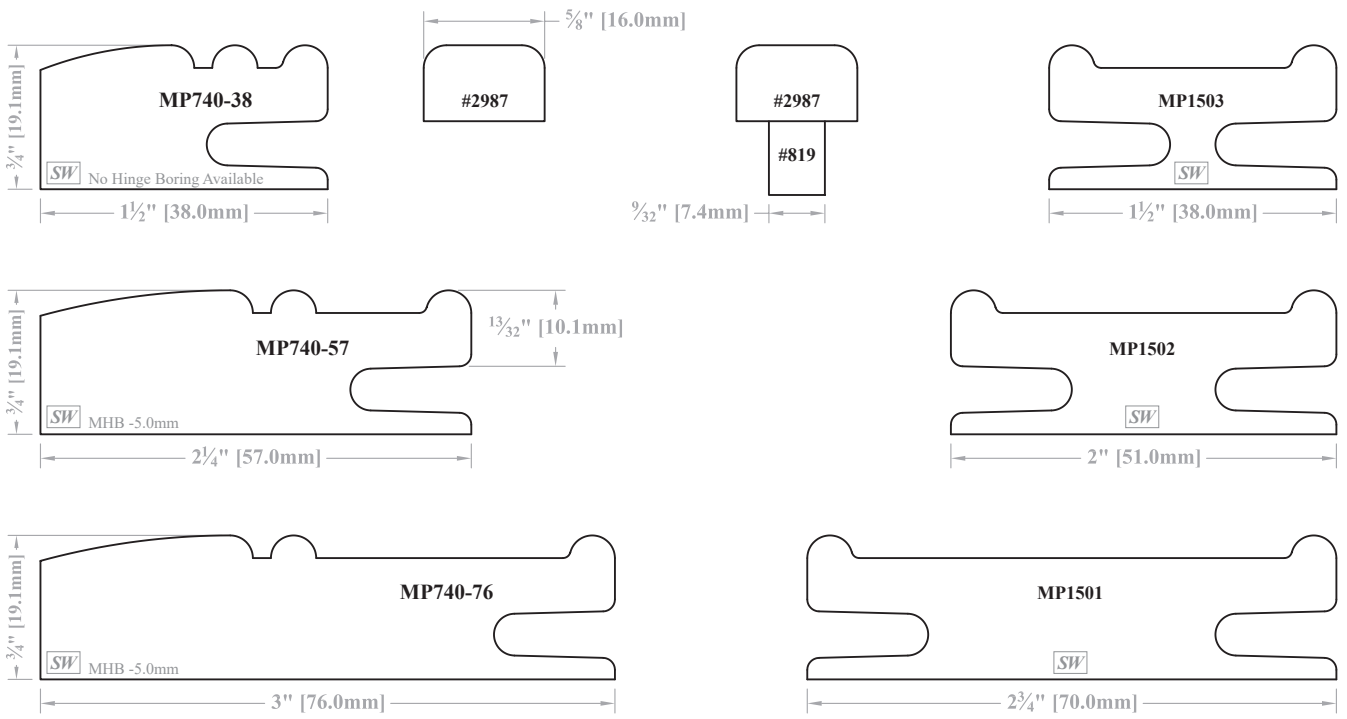

SW = Available in Solid Wood.

C = Available for Convex/Concave products.

MHB = Minimum Hinge Bore setback calculated at 12.7mm deep.

► For PRICING ► See Section E.10 in our current Wholesale Pricing Catalog.

Profile Options

Stile & Rail - Mitered Mortise & Tenon Joinery - MP700 Series

Mitered Stile & Rail Profiles with Matching Mullion Stock

MP742 Family

Center Stiles & Rails will look like these profiles.

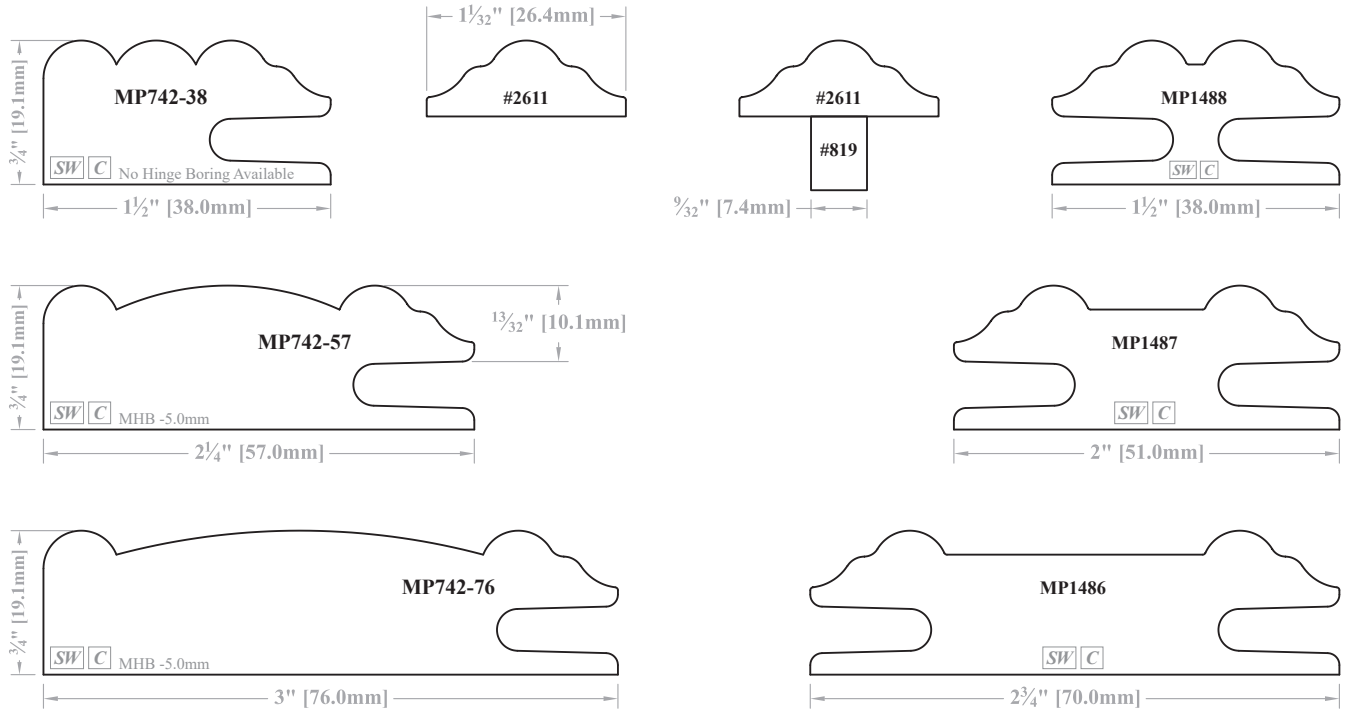

MP744 Family

Molding is not included with this family and must be ordered separately. See Profile Options Note for corner block recommendation.

Center Stiles & Rails will look like these profiles.

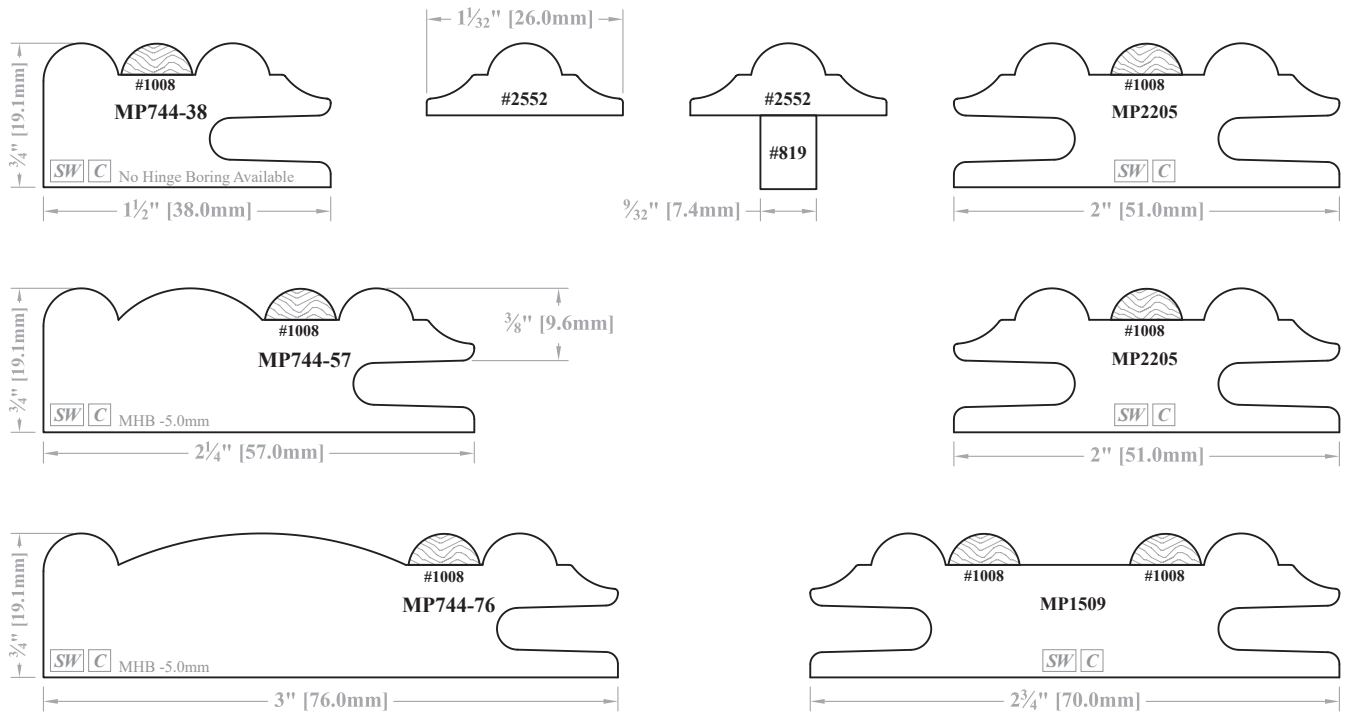

SW = Available in Solid Wood.

C = Available for Convex/Concave products.

MHB = Minimum Hinge Bore setback calculated at 12.7mm deep.

► For PRICING ► See Section E.10 in our current Wholesale Pricing Catalog.

Mitered Stile & Rail Profiles with Matching Mullion Stock

MP751 Family

Center Stiles & Rails will look like these profiles.

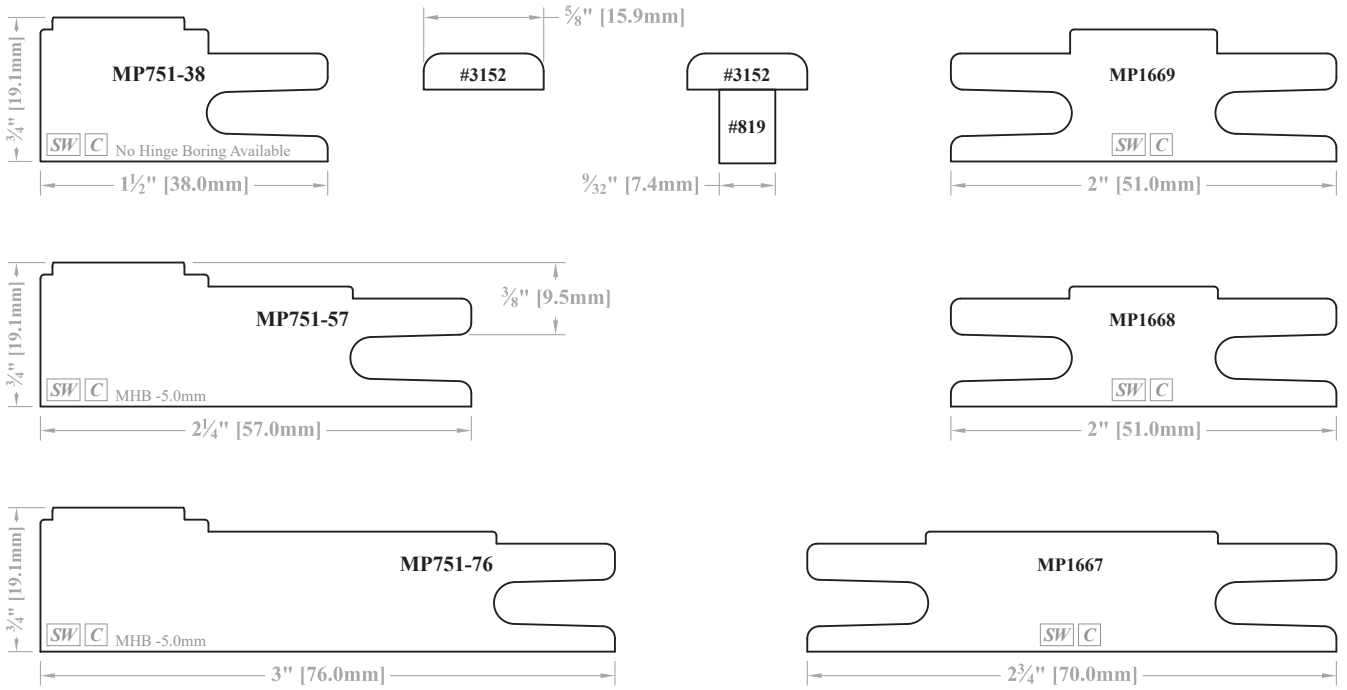

MP754 Family

Center Stiles & Rails will look like these profiles.

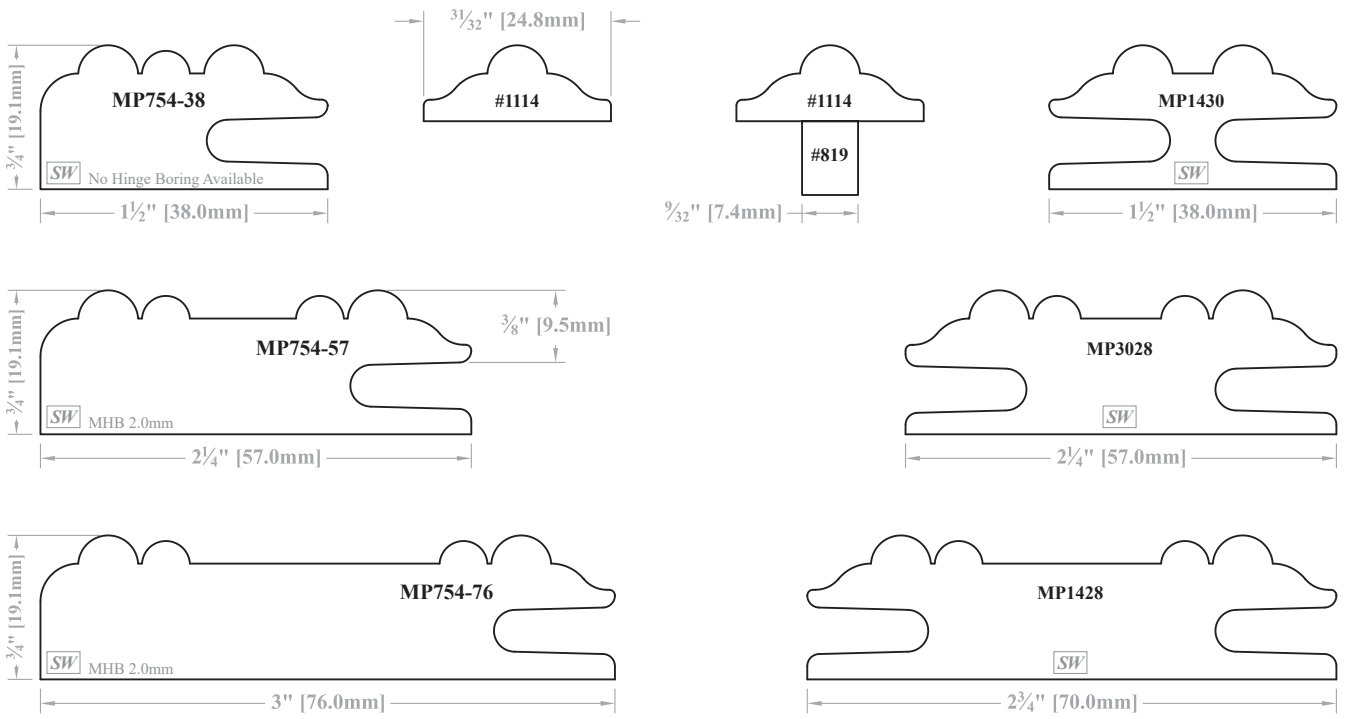

SW = Available in Solid Wood.

C = Available for Convex/Concave products.

MHB = Minimum Hinge Bore setback calculated at 12.7mm deep.

► For PRICING ► See Section E.10 in our current Wholesale Pricing Catalog.

Profile Options

Stile & Rail - Mitered Mortise & Tenon Joinery - MP700 Series

Mitered Stile & Rail Profiles with Matching Mullion Stock

MP759 Family

(X) = Applied Molding Shelf, molding is optional

Center Stiles & Rails will look like these profiles.

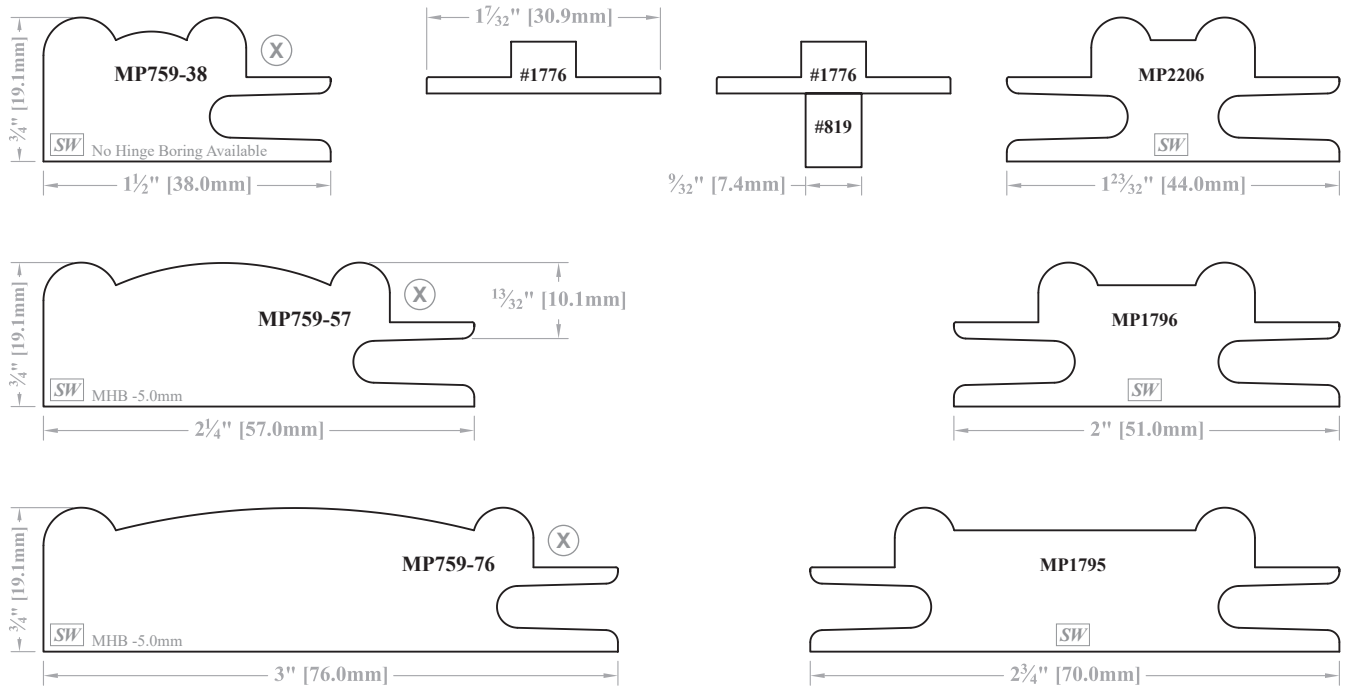

MP761 Family

Center Stiles & Rails will look like these profiles.

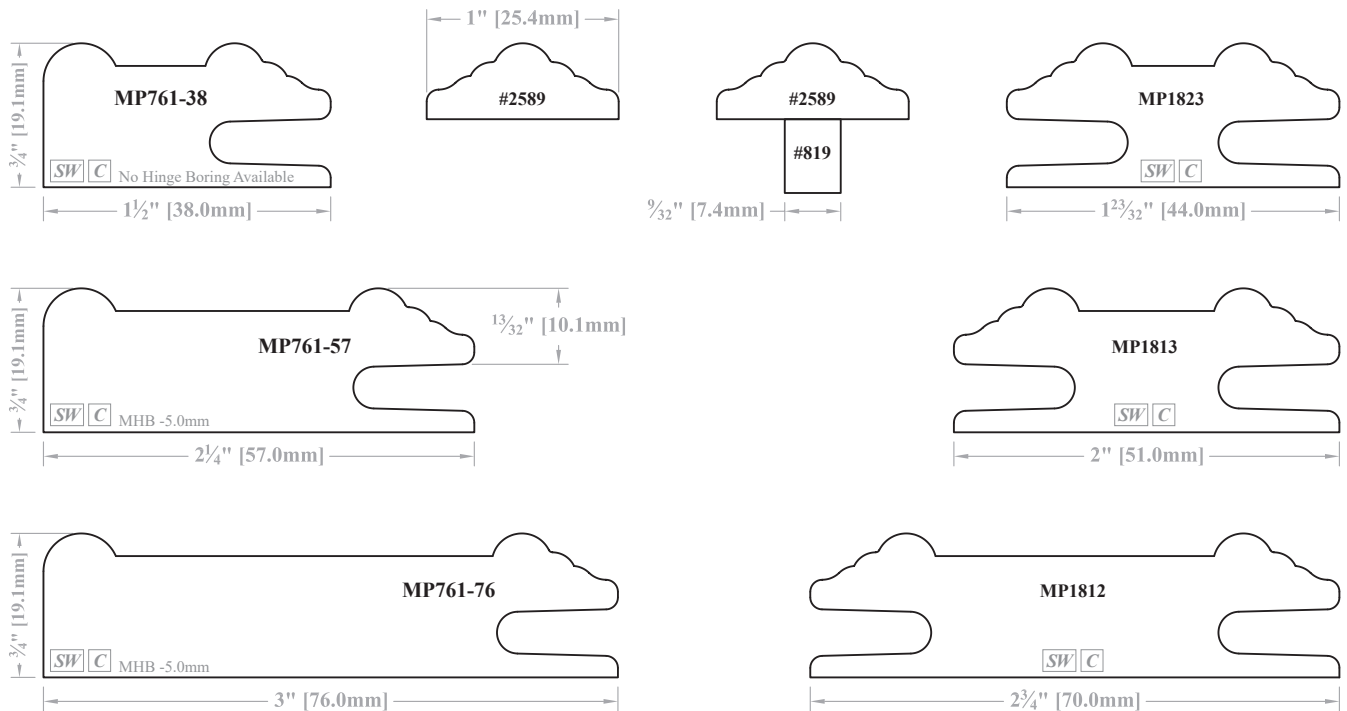

SW = Available in Solid Wood.

C = Available for Convex/Concave products.

MHB = Minimum Hinge Bore setback calculated at 12.7mm deep.

► For PRICING ► See Section E.10 in our current Wholesale Pricing Catalog.



Mitered Stile & Rail Profiles with Matching Mullion Stock

MP760 Family

Center Stiles & Rails will look like these profiles.

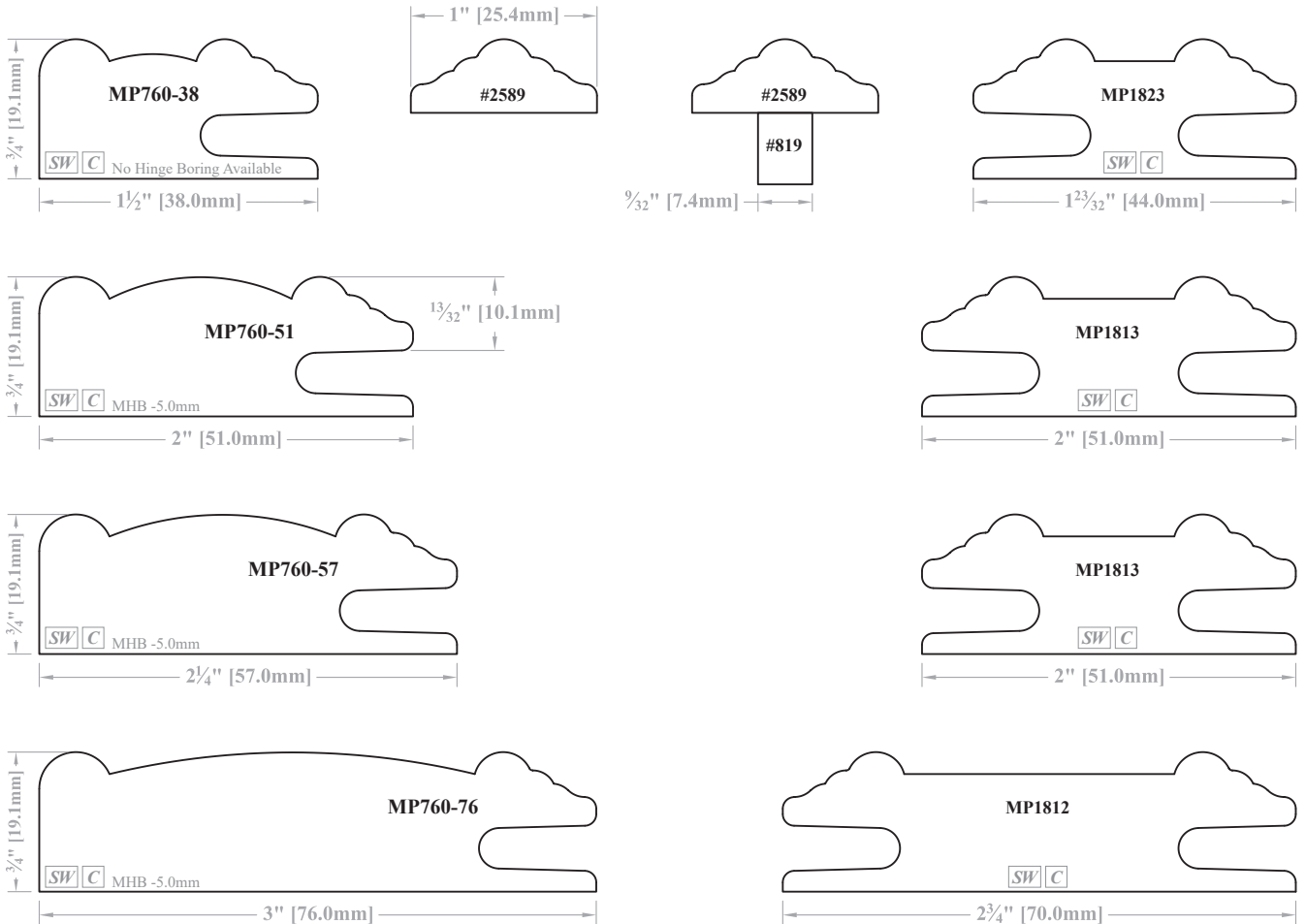

E

[SW] = Available in Solid Wood. [C] = Available for Convex/Concave products. MHB = Minimum Hinge Bore setback calculated at 12.7mm deep.

► For PRICING ► See Section E.10 in our current Wholesale Pricing Catalog.

Profile Options

Stile & Rail - Mitered Mortise & Tenon Joinery - MP700 Series

Mitered Stile & Rail Profiles with Matching Mullion Stock

MP762 Family

Center Stiles & Rails will look like these profiles.

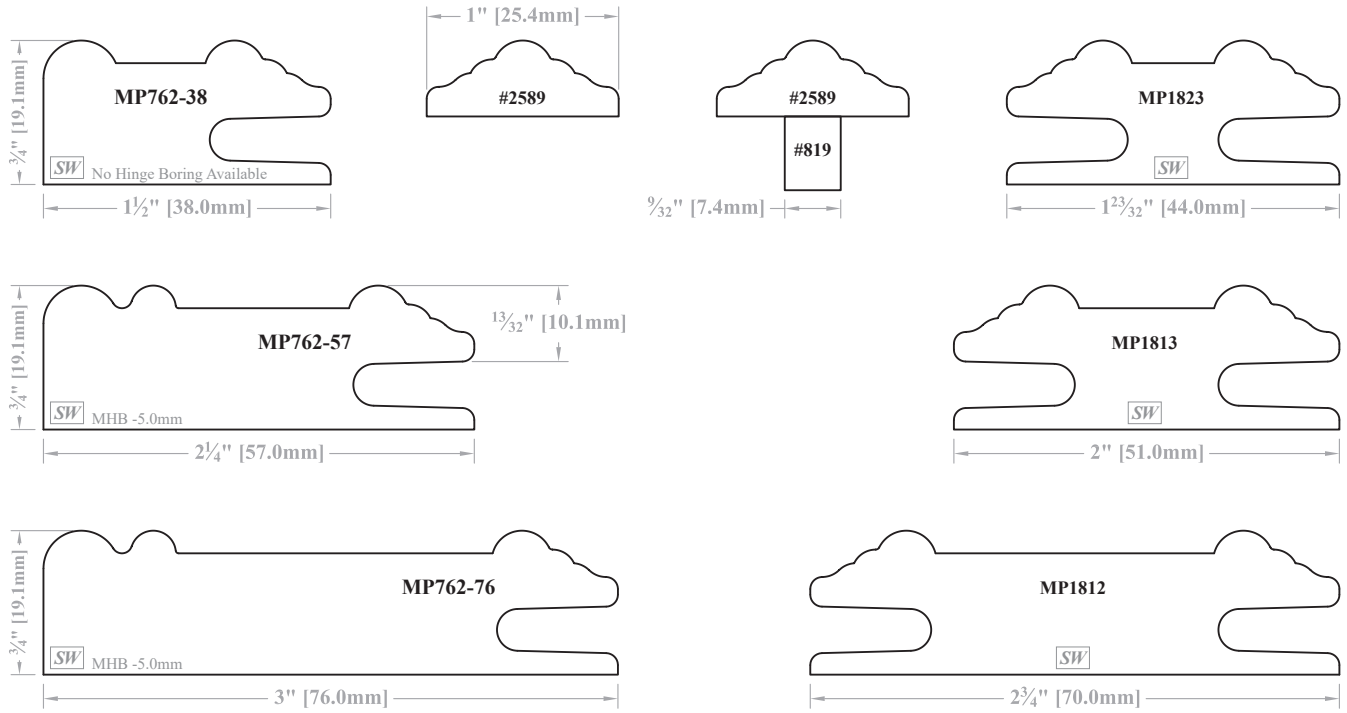

MP763 Family

Molding is not included with this family and must be ordered separately. See Profile Options note for corner block recommendation.

Center Stiles & Rails will look like these profiles.

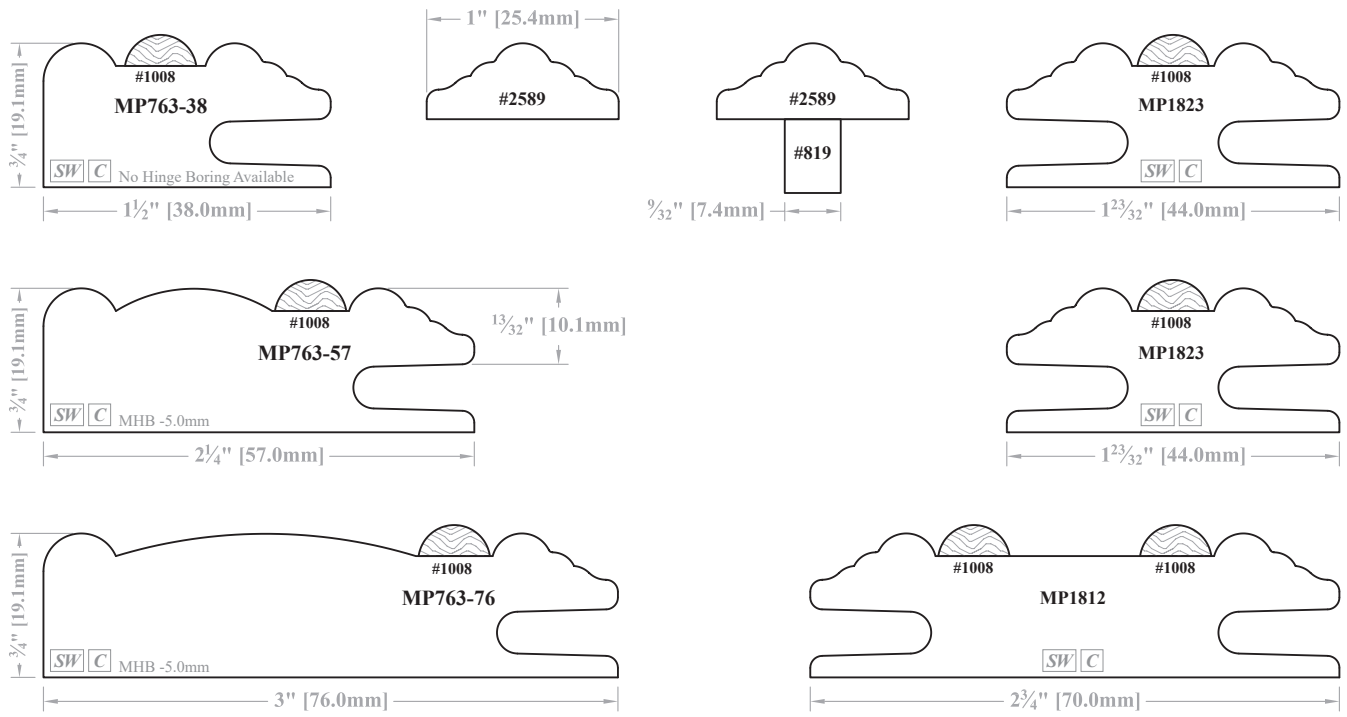

(SW) = Available in Solid Wood.

(C) = Available for Convex/Concave products.

MHB = Minimum Hinge Bore setback calculated at 12.7mm deep.

► For PRICING ► See Section E.10 in our current Wholesale Pricing Catalog.



Mitered Stile & Rail Profiles with Matching Mullion Stock

MP764 Family

Center Stiles & Rails will look like these profiles.

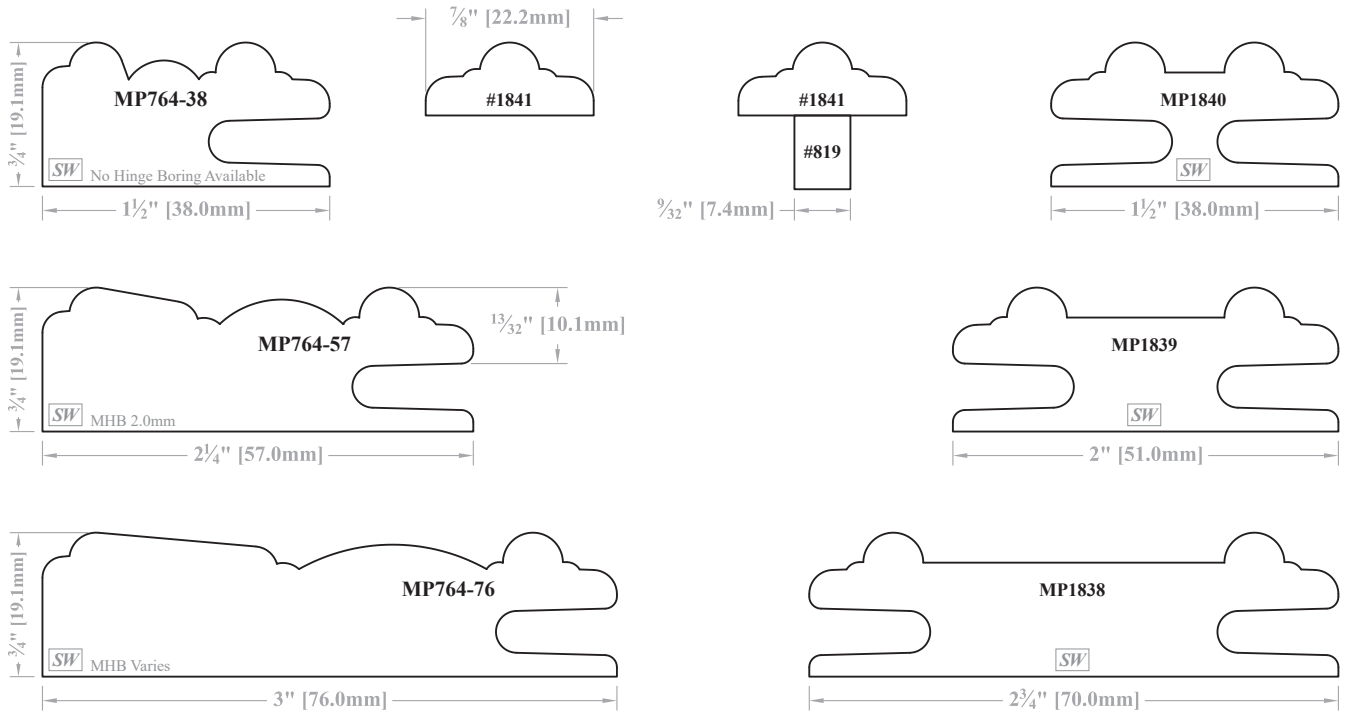

MP765 Family

Center Stiles & Rails will look like these profiles.

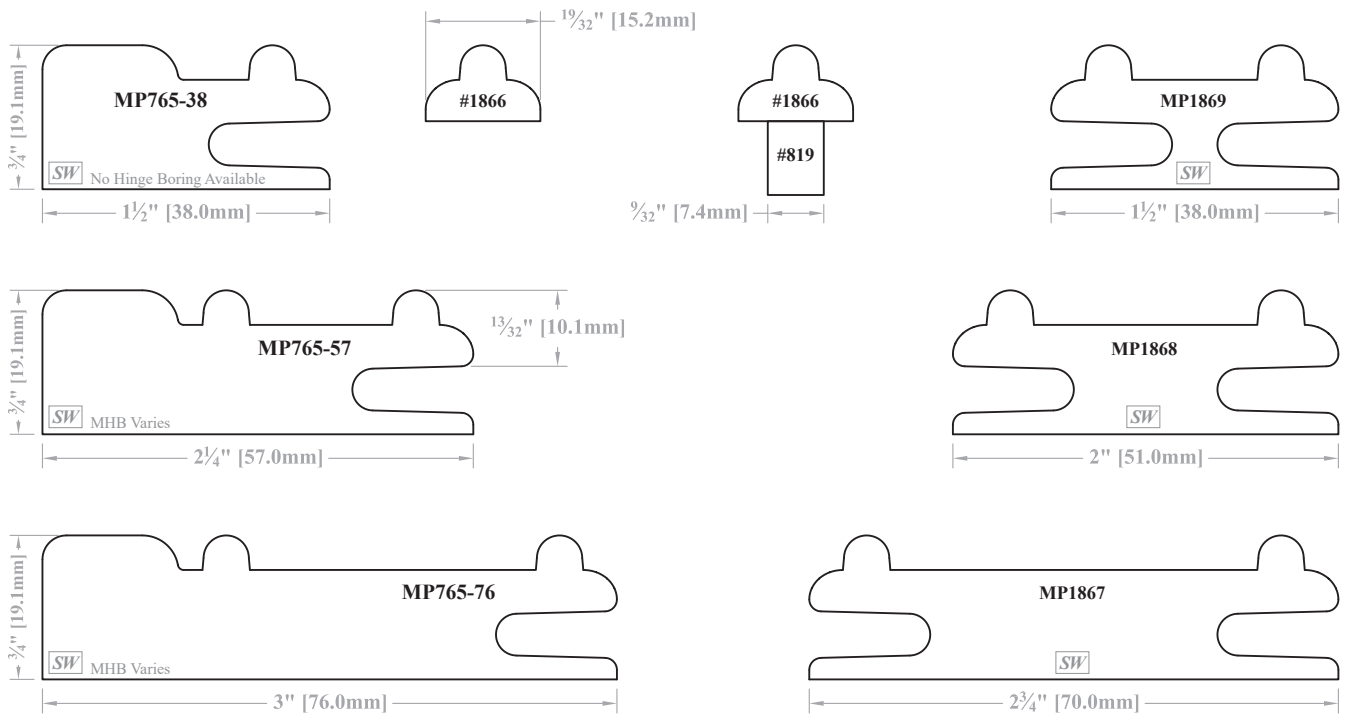

[SW] = Available in Solid Wood.

[C] = Available for Convex/Concave products.

MHB = Minimum Hinge Bore setback calculated at 12.7mm deep.

► For PRICING ► See Section E.10 in our current Wholesale Pricing Catalog.

Profile Options

Stile & Rail - Mitered Mortise & Tenon Joinery - MP700 Series

Mitered Stile & Rail Profiles with Matching Mullion Stock

MP766 Family

Center Stiles & Rails will look like these profiles.

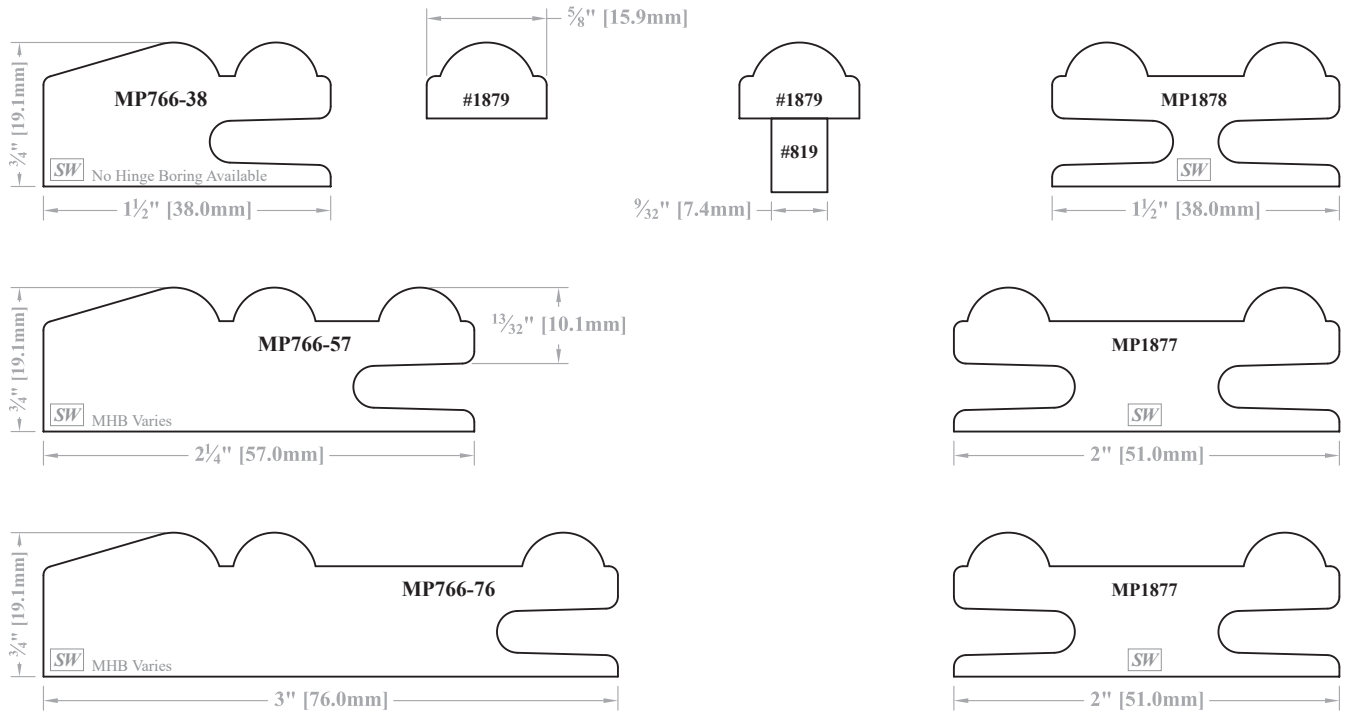

MP767 Family

Center Stiles & Rails will look like these profiles.

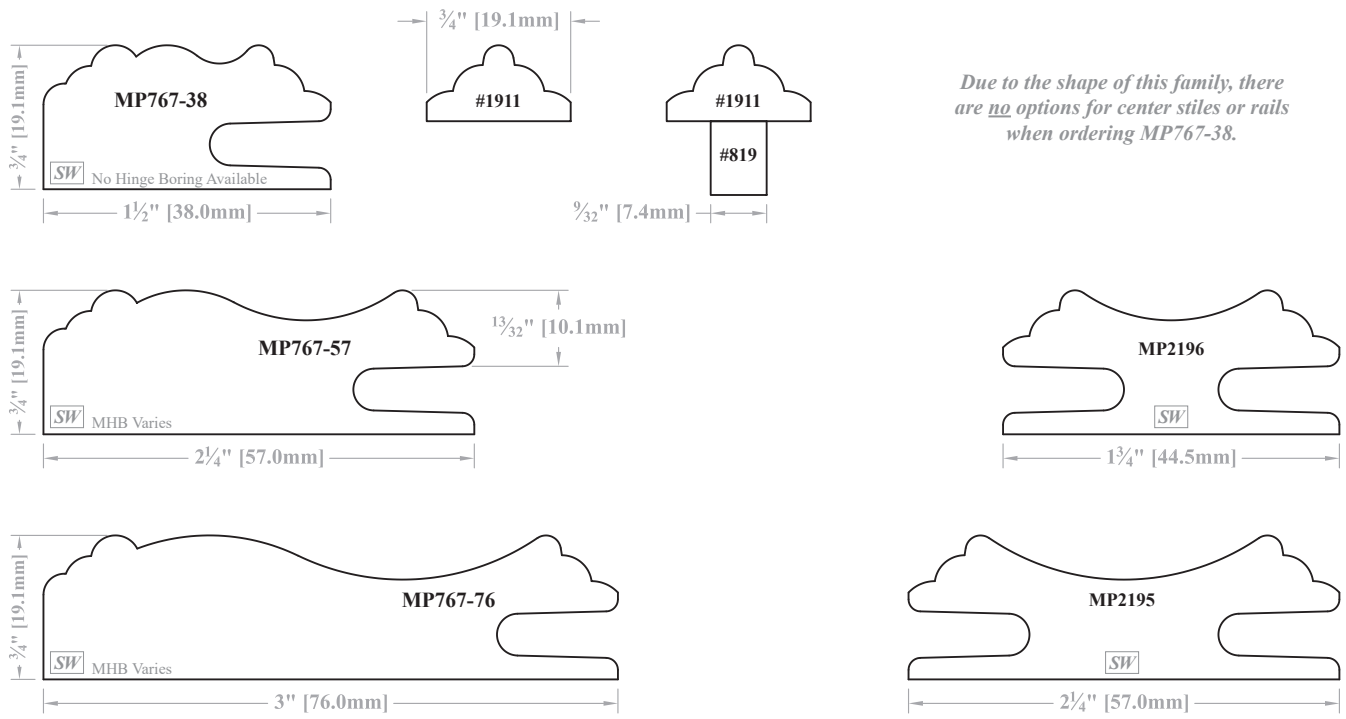

Due to the shape of this family, there are no options for center stiles or rails when ordering MP767-38.

[SW] = Available in Solid Wood.

[C] = Available for Convex/Concave products.

MHB = Minimum Hinge Bore setback calculated at 12.7mm deep.

► For PRICING ► See Section E.10 in our current Wholesale Pricing Catalog.

Mitered Stile & Rail Profiles with Matching Mullion Stock

MP769 Family

Center Stiles & Rails will look like these profiles.

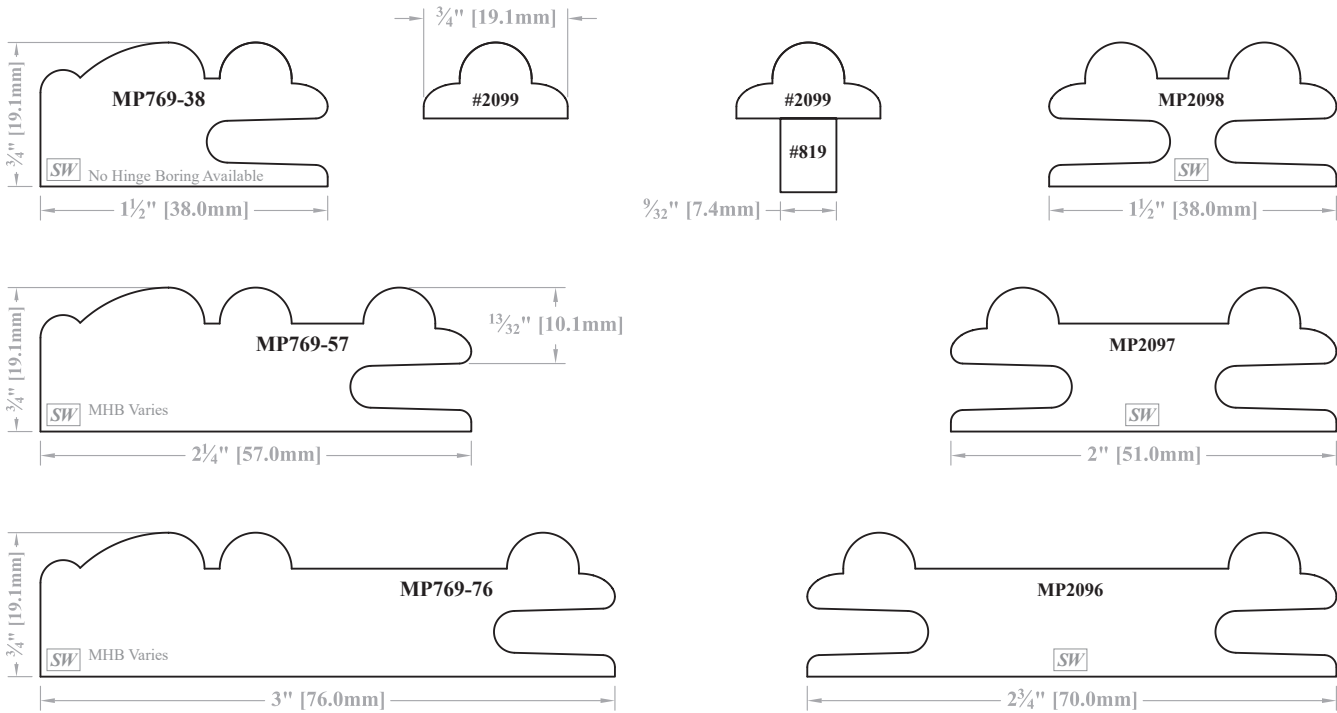

MP770 Family

Center Stiles & Rails will look like these profiles.

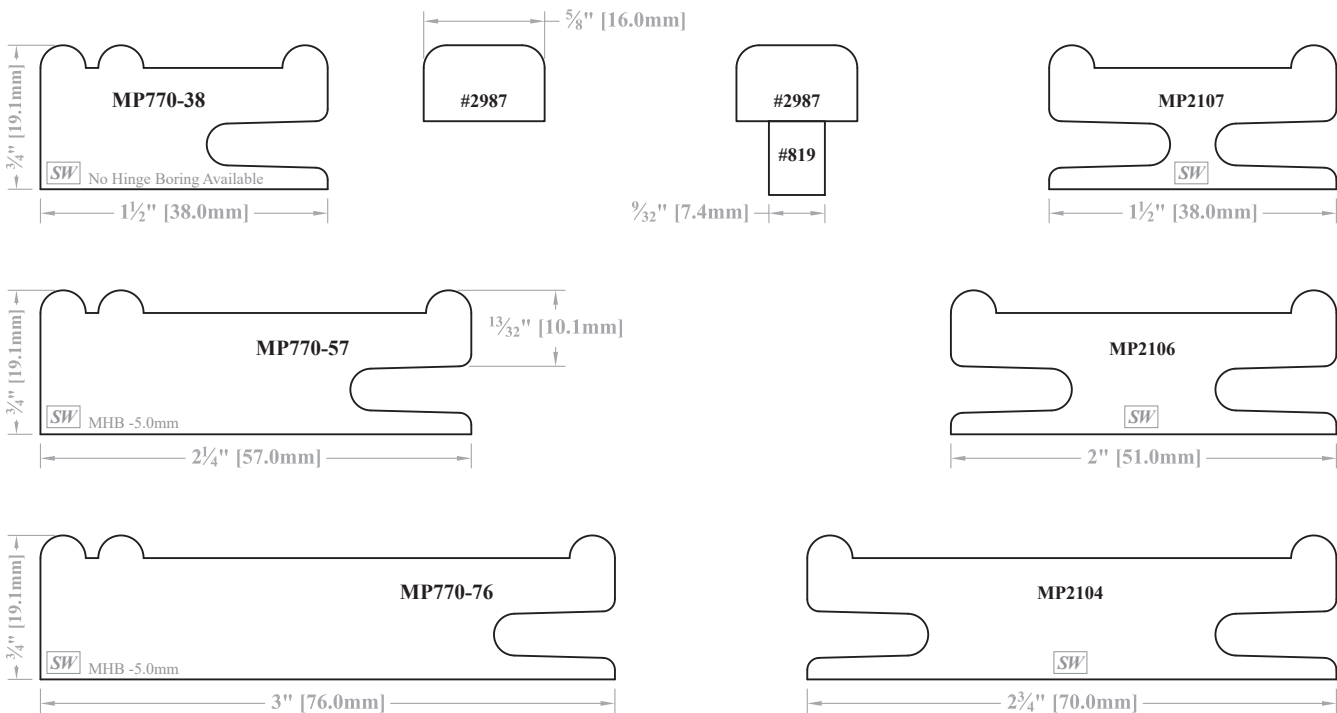

[SW] = Available in Solid Wood.

[C] = Available for Convex/Concave products.

MHB = Minimum Hinge Bore setback calculated at 12.7mm deep.

► For PRICING ► See Section E.10 in our current Wholesale Pricing Catalog.

Profile Options

Stile & Rail - Mitered Mortise & Tenon Joinery - MP700 Series

Mitered Stile & Rail Profiles with Matching Mullion Stock

MP771 Family

Center Stiles & Rails will look like these profiles.

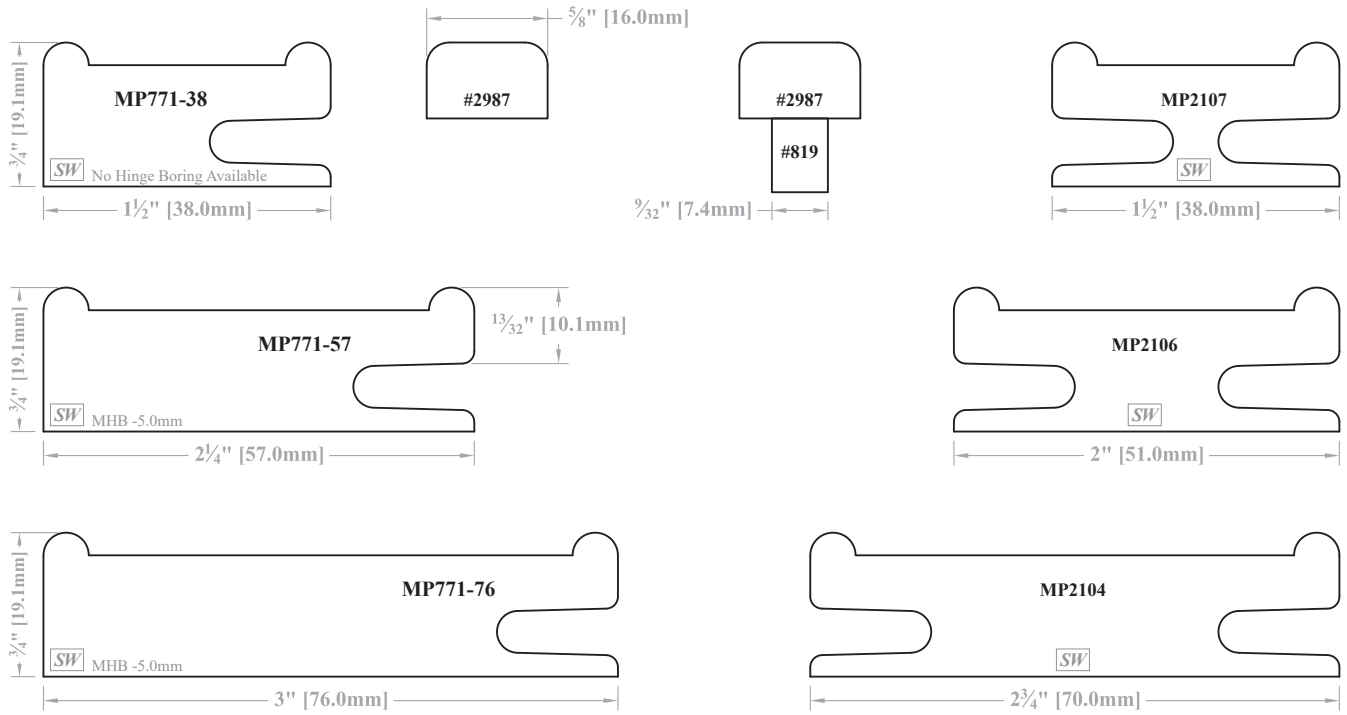

MP772 Family

Center Stiles & Rails will look like these profiles.

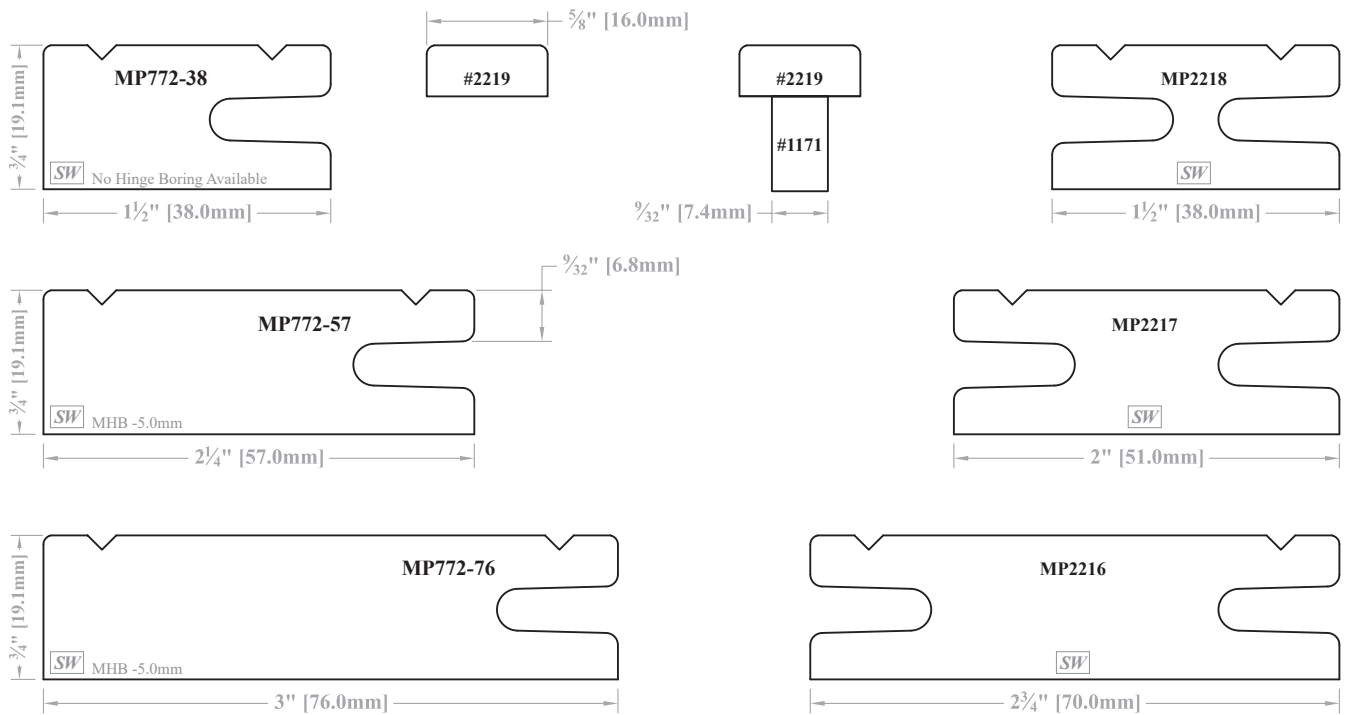

SW = Available in Solid Wood.

C = Available for Convex/Concave products.

MHB = Minimum Hinge Bore setback calculated at 12.7mm deep.

► For PRICING ► See Section E.10 in our current Wholesale Pricing Catalog.

Mitered Stile & Rail Profiles with Matching Mullion Stock

MP773 Family

Center Stiles & Rails will look like these profiles.

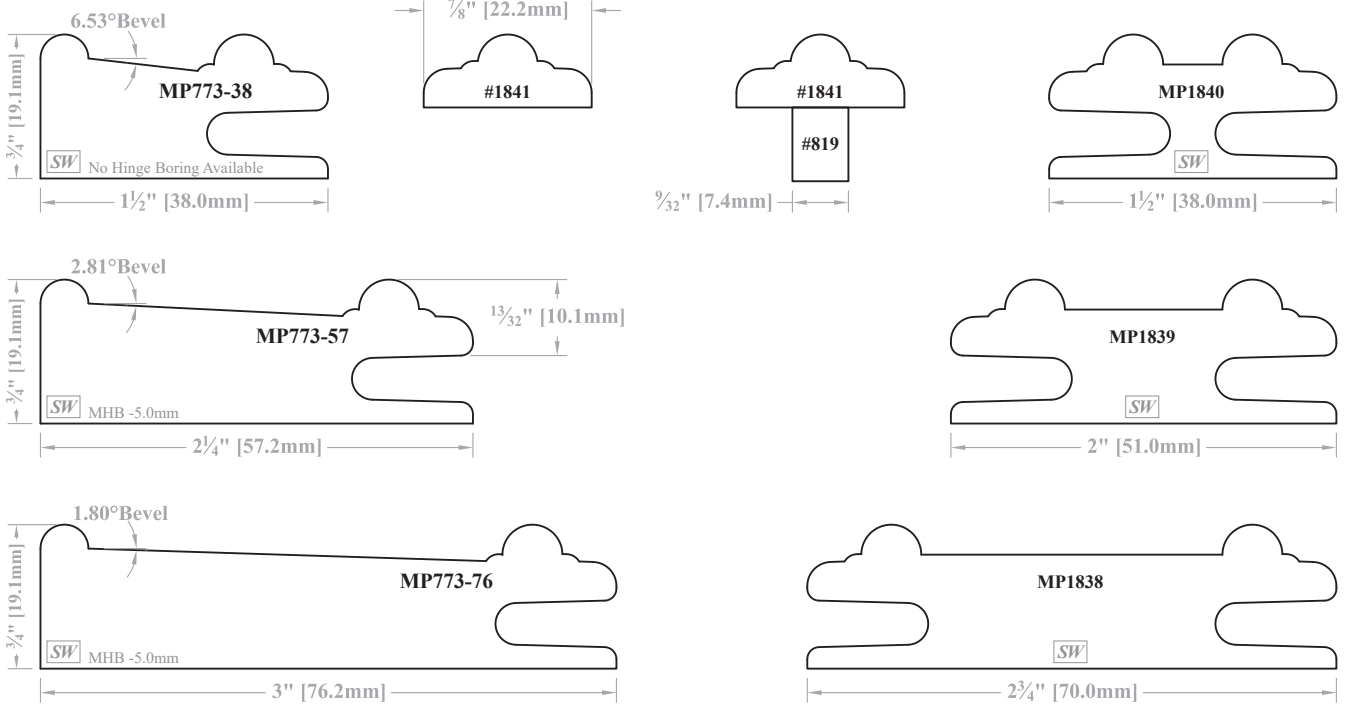

MP774 Family

Center Stiles & Rails will look like these profiles.

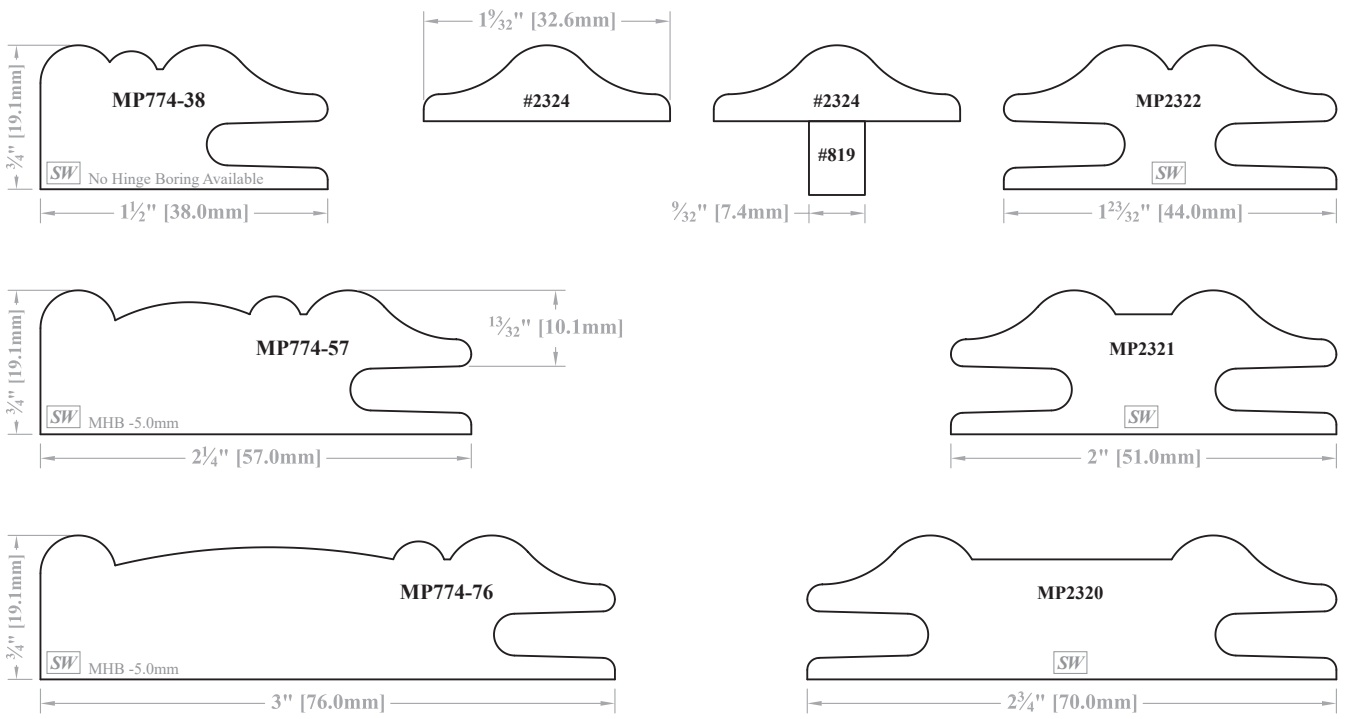

SW = Available in Solid Wood.

C = Available for Convex/Concave products.

MHB = Minimum Hinge Bore setback calculated at 12.7mm deep.

► For PRICING ► See Section E.10 in our current Wholesale Pricing Catalog.

Profile Options

Stile & Rail - Mitered Mortise & Tenon Joinery - MP700 Series

Mitered Stile & Rail Profiles with Matching Mullion Stock

MP775 Family

Center Stiles & Rails will look like these profiles.

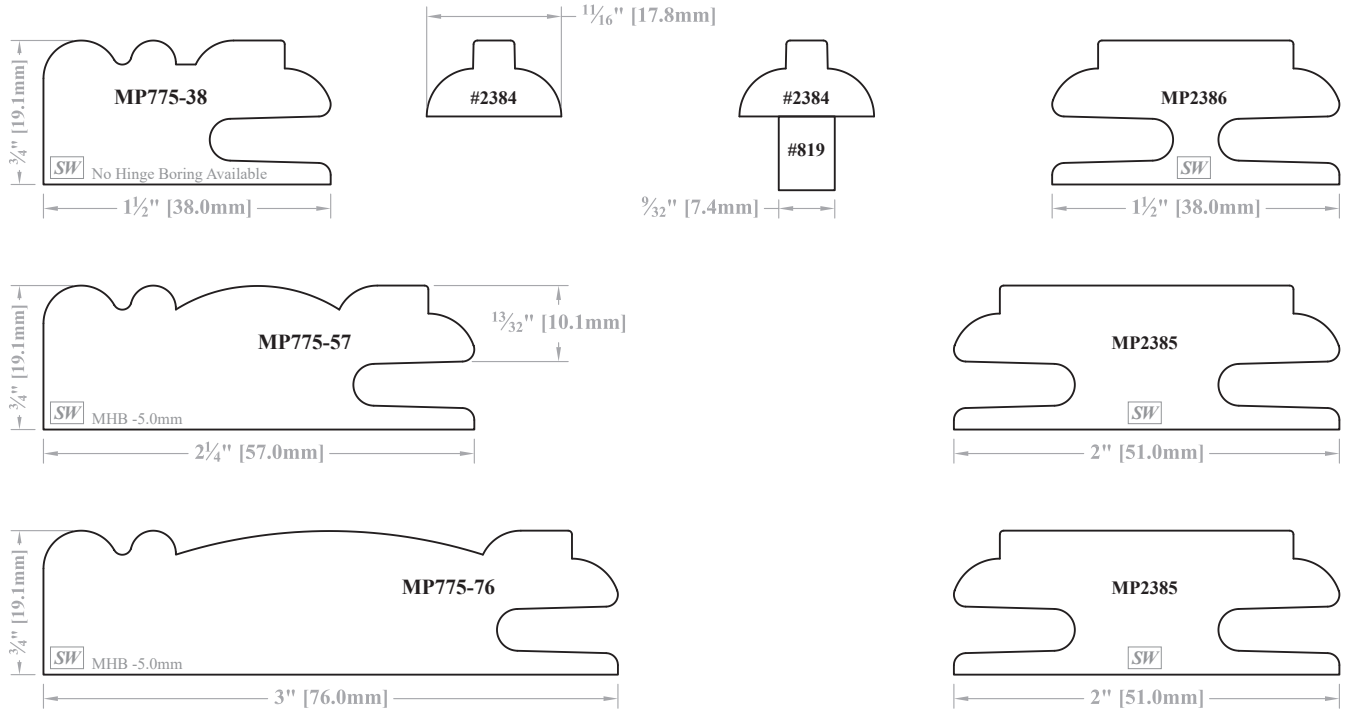

MP776 Family

Center Stiles & Rails will look like these profiles.

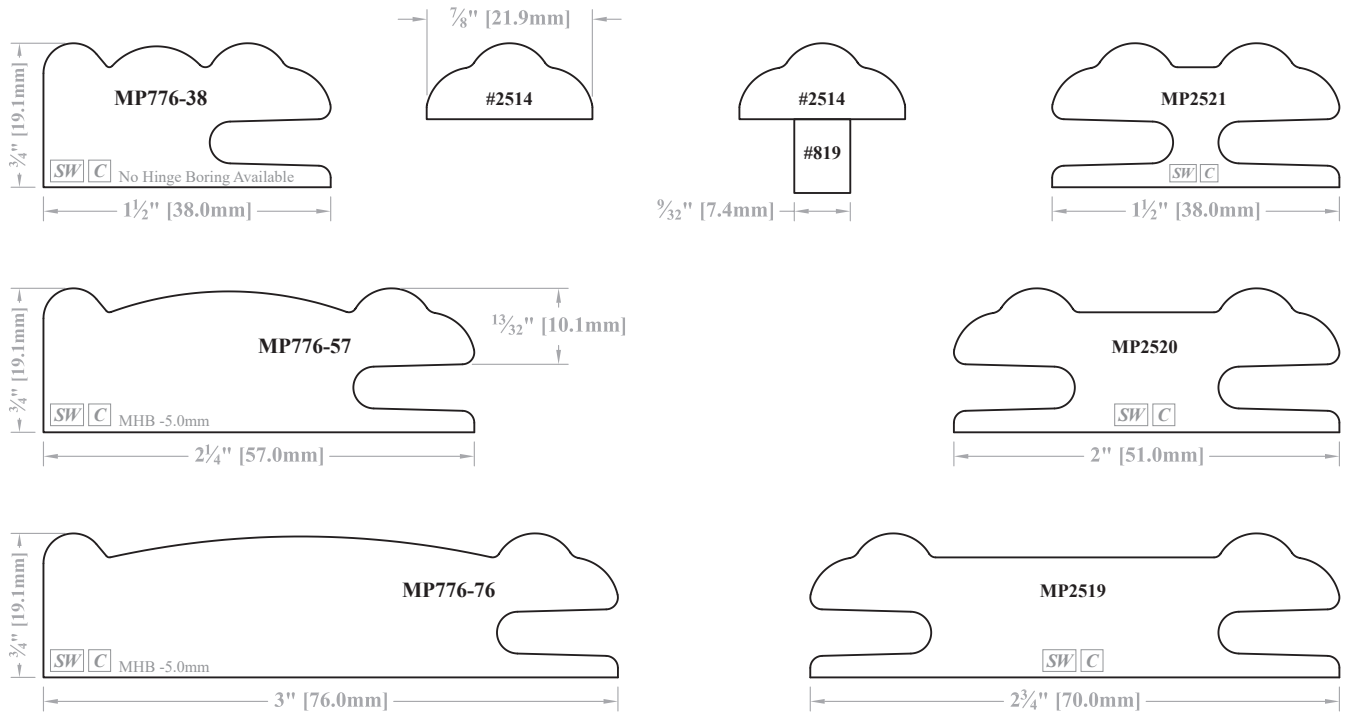

[SW] = Available in Solid Wood.

[C] = Available for Convex/Concave products.

MHB = Minimum Hinge Bore setback calculated at 12.7mm deep.

► For PRICING ► See Section E.10 in our current Wholesale Pricing Catalog.

Mitered Stile & Rail Profiles with Matching Mullion Stock

MP777 Family

Center Stiles & Rails will look like these profiles.

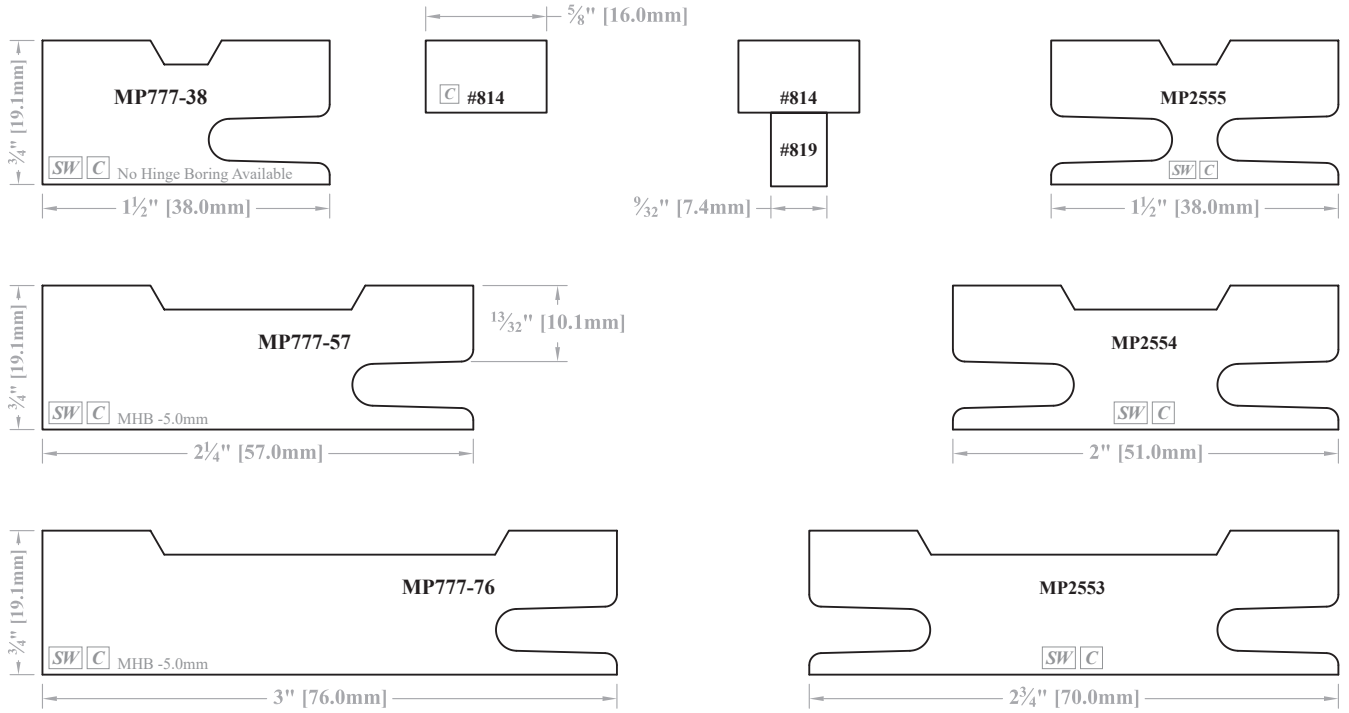

MP780 Family

Center Stiles & Rails will look like these profiles.

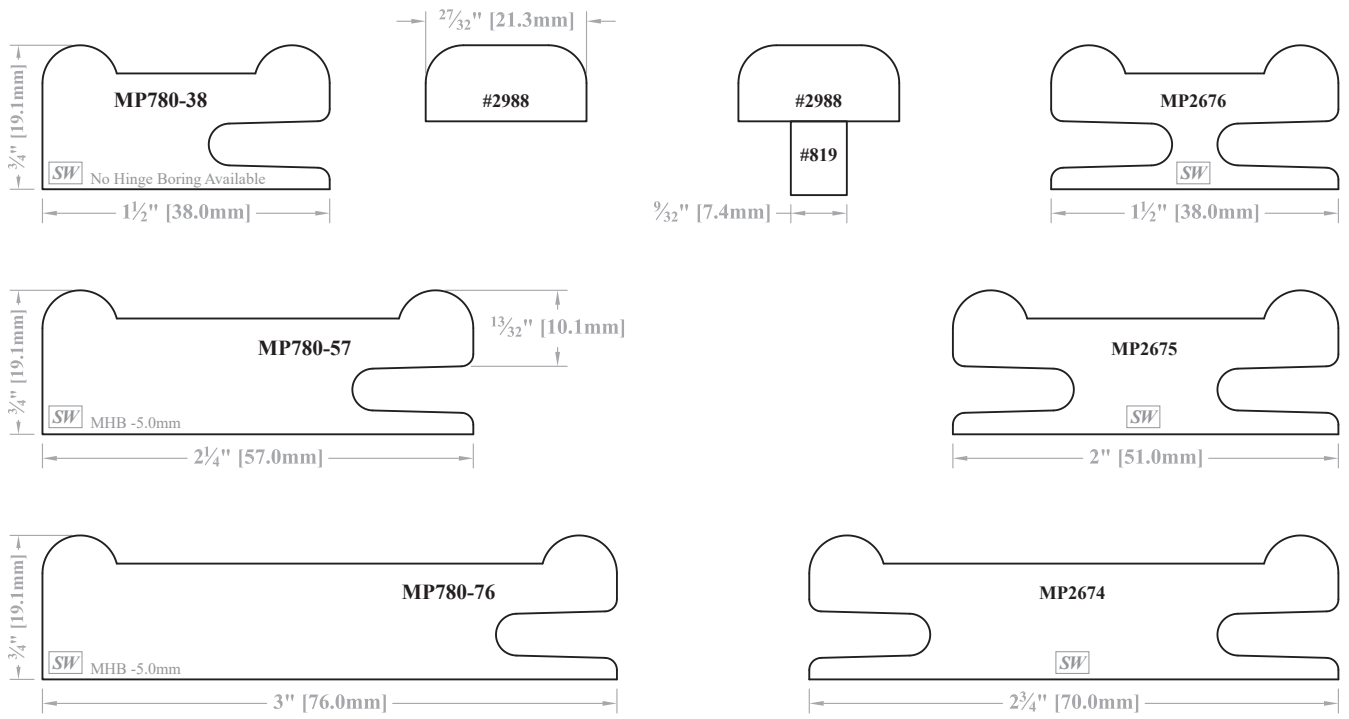

SW = Available in Solid Wood.

C = Available for Convex/Concave products.

MHB = Minimum Hinge Bore setback calculated at 12.7mm deep.

► For PRICING ► See Section E.10 in our current Wholesale Pricing Catalog.

Profile Options

Stile & Rail - Mitered Mortise & Tenon Joinery - MP700 Series

Mitered Stile & Rail Profiles with Matching Mullion Stock

MP779 Family

Center Stiles & Rails will look like these profiles.

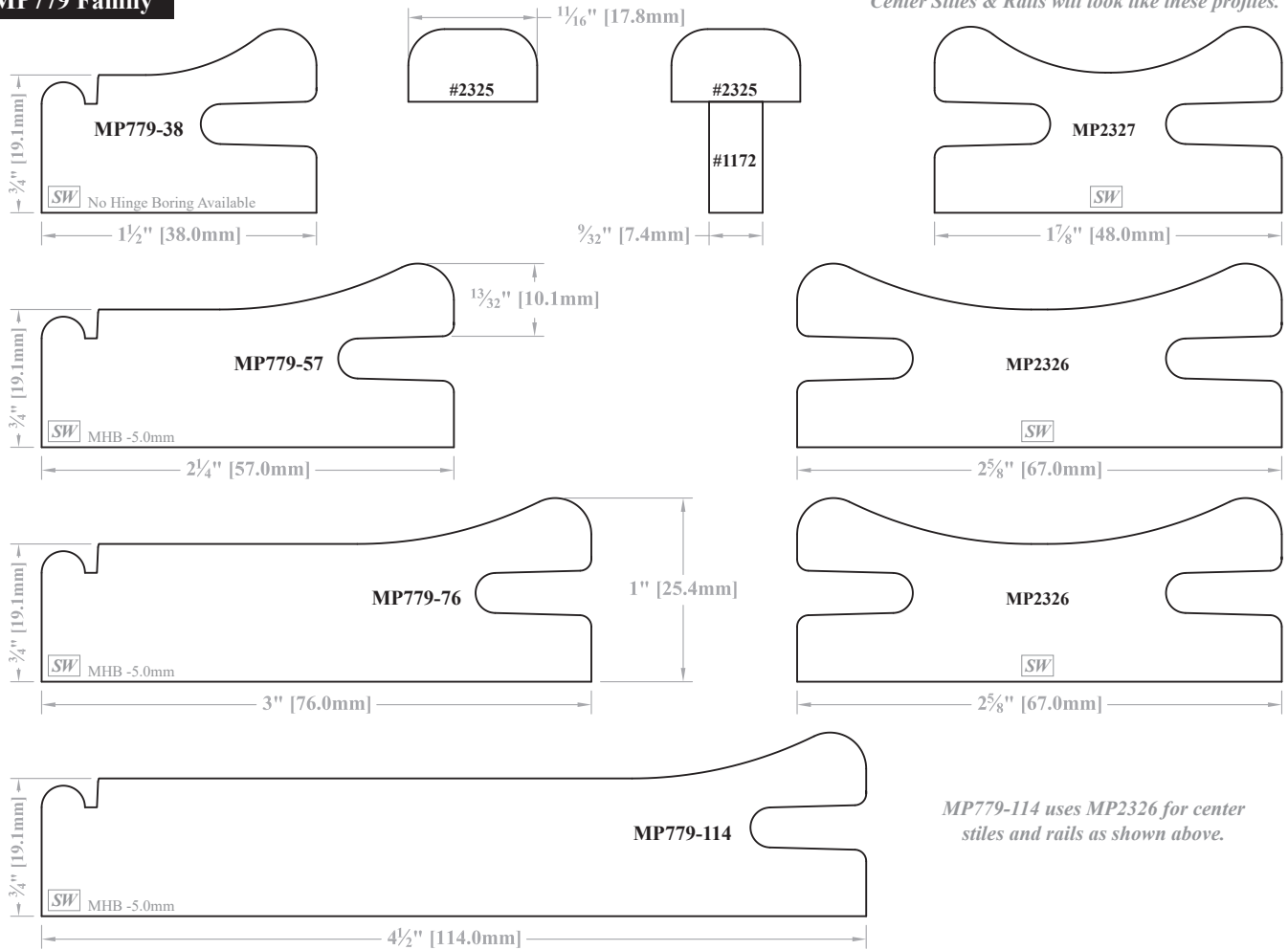

MP779-114 uses MP2326 for center stiles and rails as shown above.

Must be ordered at 1" [25.4mm] thick. Add 30% for 1" [25.4mm] thickness.

SW = Available in Solid Wood.

C = Available for Convex/Concave products.

MHB = Minimum Hinge Bore setback calculated at 12.7mm deep.

► For PRICING ► See Section E.10 in our current Wholesale Pricing Catalog.

E.10.24
V18.2



WalzCraft.com



(Phone) 1-800-237-1326 6:00AM - 5:30PM CST (24 Hour Fax) 1-608-781-3667

Mitered Stile & Rail Profiles with Matching Mullion Stock

MP781 Family

Center Stiles & Rails will look like these profiles.

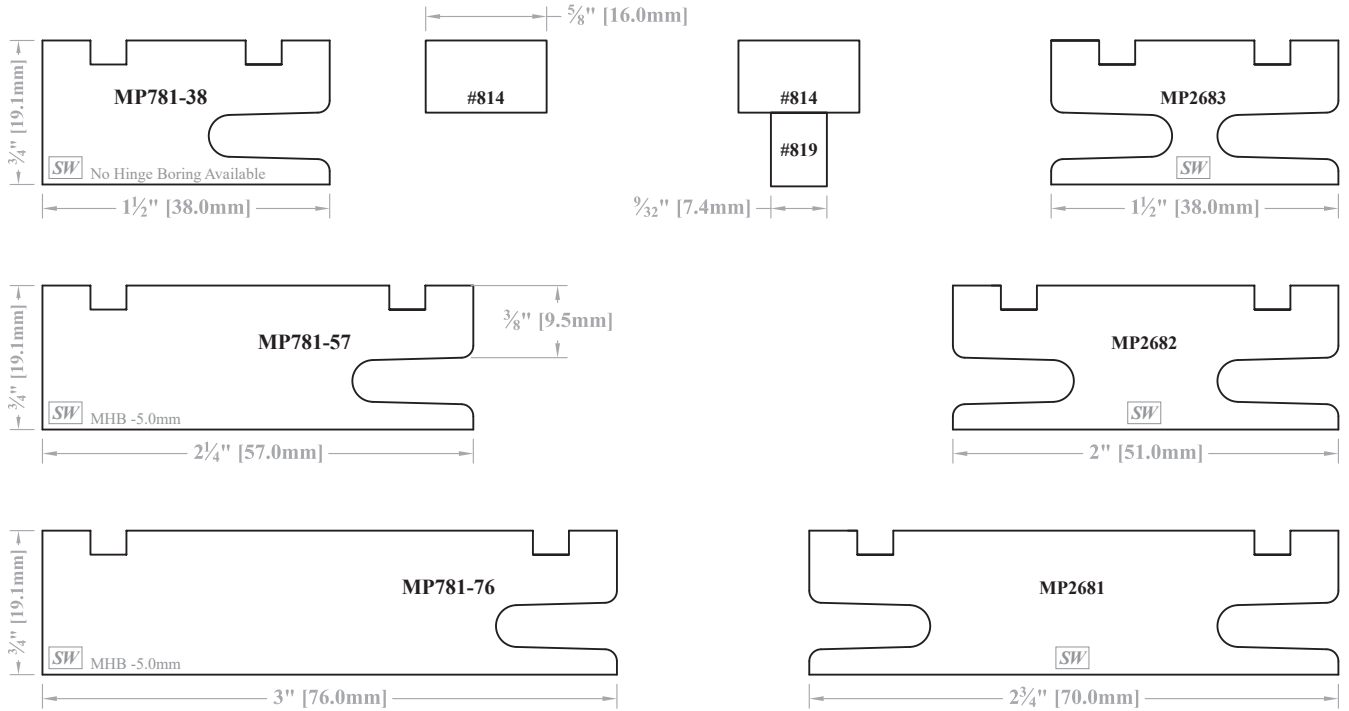

MP782 Family

Center Stiles & Rails will look like these profiles.

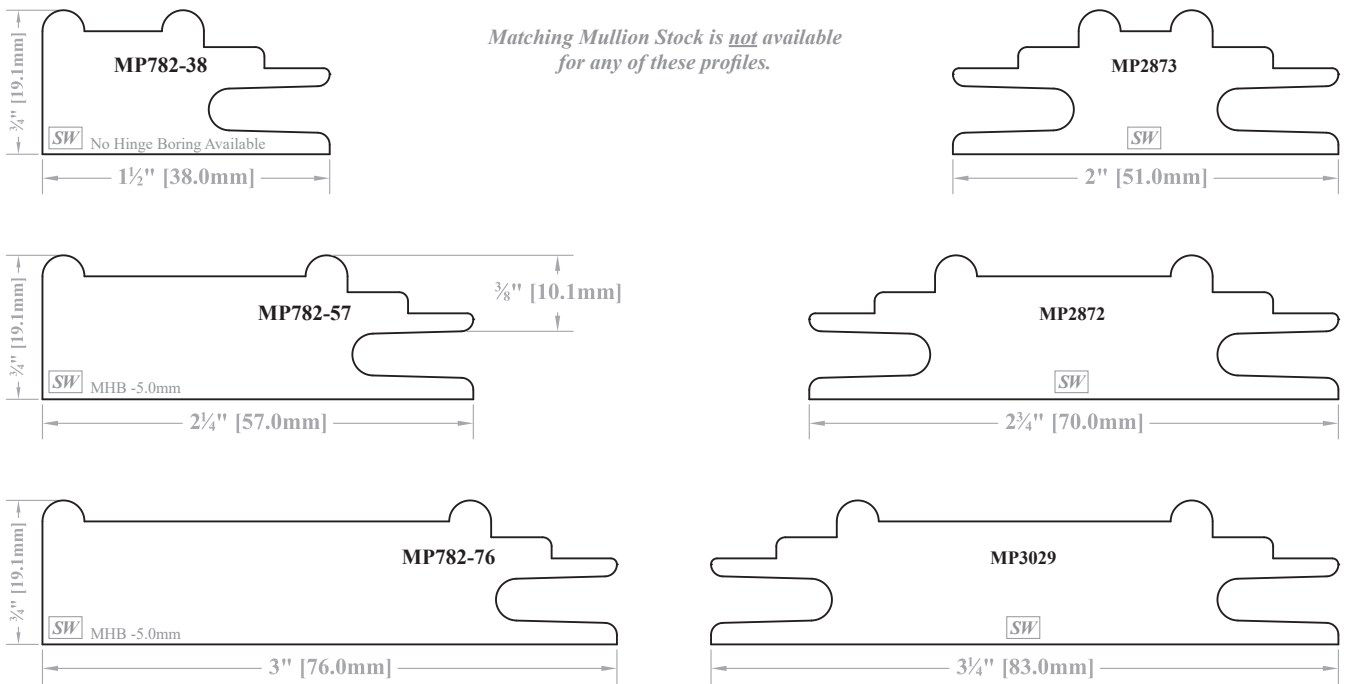

[SW] = Available in Solid Wood.

[C] = Available for Convex/Concave products.

MHB = Minimum Hinge Bore setback calculated at 12.7mm deep.

► For PRICING ► See Section E.10 in our current Wholesale Pricing Catalog.

Profile Options

Stile & Rail - Mitered Mortise & Tenon Joinery - MP700 Series

Mitered Stile & Rail Profiles with Matching Mullion Stock

MP783 Family

Center Stiles & Rails will look like these profiles.

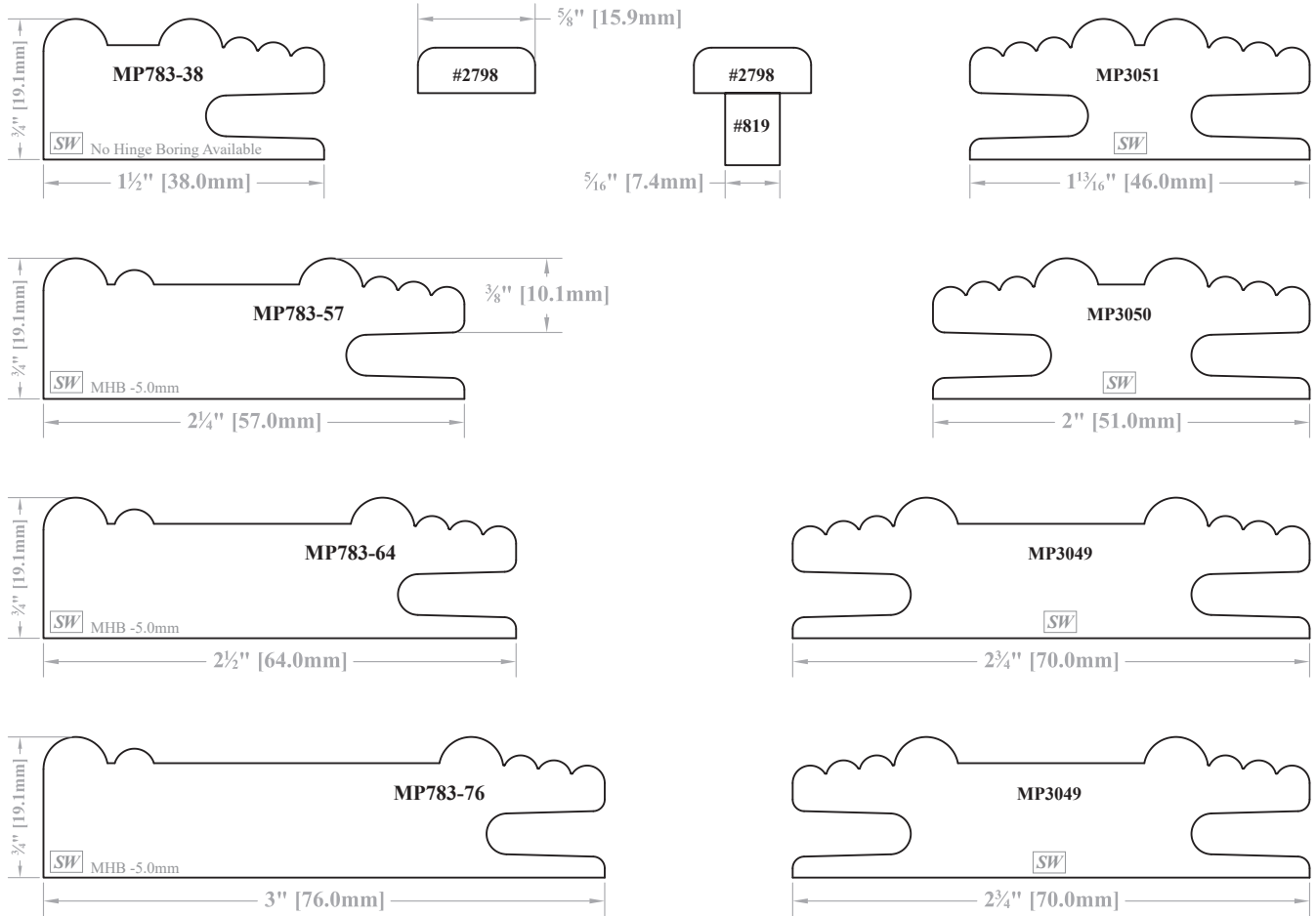

E

SW = Available in Solid Wood.

C = Available for Convex/Concave products.

MHB = Minimum Hinge Bore setback calculated at 12.7mm deep.

► For PRICING ► See Section E.10 in our current Wholesale Pricing Catalog.

E.10.26
V18.2



WalzCraft.com



(Phone) 1-800-237-1326 6:00AM - 5:30PM CST (24 Hour Fax) 1-608-781-3667

Ordering & Pricing Notes: MP700 Series Miter Door & Drawer Front Profiles

Ordering Guidelines

1	Order Forms	Applicable order forms will include spaces to indicate your chosen profiles.
Pricing		
1	Pricing	Please see <i>Section E.10</i> of our current Wholesale Pricing Catalog.

Technical Notes: MP700 Series Miter Door & Drawer Front Profiles

Cabinet Door & Drawer Front Options (Chapter B)

1	Mitered Frame or Mullion Doors	All of the mitered profiles shown in this catalog are also available with the GRF profile. When ordering, please indicate whether the door is a frame or mullion. If a mullion, please indicate the lite pattern and number of lites. <i>Not all mitered profiles are available with mullions.</i>
---	--------------------------------	--

Design Options (Chapter G)

1	Mitered Stile and Rail Stock (Part #SRP100)	Mitered stile & rail stock is produced and priced the same as Traditional stile & rail stock with an outside edge. Available in 8' [2438.4mm], Random Length and Cut to Length sizes. See <i>Section G.16</i> for additional information and pricing guidelines. To order please use <i>E-Z Order Form #5 - Moldings & Miscellaneous</i> and Part #SRP100.
---	---	--

General Information (Chapter A)

1	Ready to Assemble (RTA)	RTA is available as an option.
---	-------------------------	--------------------------------

Material Options

1	Material Options	SW = Profile is available on products made from solid wood.
---	------------------	---

Functional Options (Chapter F)

1	1½" [38.1mm] Wide Profiles	Hinge boring is <i>not available</i> for any of the 1½" [38.1mm] wide miter profiles.
2	Hinge Boring & Finger Pulls	Please reference the Miter Compatibility chart for more information. Compatibility charts can be found on our website under Resources/Technical Information . MHB = Minimum Hinge Bore setback calculated at 12.7mm deep.

Miscellaneous

1	Center Stile and Rail Construction	All center stiles & rails will be haunched into the outside stiles & rails creating a mitered joint where they are conjoined, <i>except MP1460 & MP1461</i> . A butt joint is used to install these center stiles & rails.
---	------------------------------------	--

Profile Options (Chapter E)

1	MP744, MP763 Families	Designed to accept Applied Molding #1008. Applied molding must be ordered separately. Corner block molding is recommended with beaded moldings where they meet at corners to prevent any mis-match that may occur. See <i>Section E.7</i> for corner block options.
2	MP772, MP779 Families	Center panels will be <i>recessed</i> below the face of the stiles and rails when using these center panel profiles: <ul style="list-style-type: none"> • PR318-25, PR319-10, PR320-25, PR320-32, PR320-44, PR321-32, PR328-32, PR329-19, RVSCP-PR324 (<i>Reversed Solid Center Panel</i>) <ul style="list-style-type: none"> ◦ Available in solid wood and raw MDF. • ¼" [6.4mm] Flat Panel <ul style="list-style-type: none"> ◦ Available in veneer and raw MDF. The MP772 and MP779 families are only compatible with the center panel profiles listed above.

Sizes/Dimensions

1	Profile Drawings	All stile & rail and mullion stock drawings are shown at full scale.
2	Thickness	Available in ¾" [19.1mm] and 1" [25.4mm] thickness, unless otherwise noted.
3	Minimum Sizes	All mitered door and drawer front minimum sizes are calculated based on 2¼" [57.2mm] wide profiles. <ul style="list-style-type: none"> • If using a 3" [76.2mm] wide profile, please add 1½" [38.1mm] to the published minimum door size. • If using a 1½" [38.1mm] wide profile, deduct 1½" [38.1mm] from the published minimum size.

Mitered Mortise & Tenon Joinery - MP700 Series - END

► For PRICING ► See Section E.10 in our current Wholesale Pricing Catalog.

Mitered Stile & Rail Profiles with Matching Mullion Stock

- The **MP900** series of profiles are fully molded and do not accommodate stile and rail width flexibility.
- Available on Mitered door styles from **Section B.5** and **B.6**.
- As a fully molded profile, there is no need to choose an outside edge profile.
- See **Technical Notes** at the end of this section for more information on **MP900** profiles.

The following symbols and abbreviations may appear on profile drawings in this section and indicate the following:

- **[SW]** Profile available on products made from solid wood only.

MP900 profiles shown are also available as a Frame or Mullion door with the **GRF** profile. Profile drawings are shown with matching mullion stock where available. See **Section B.12** and the **Technical Notes** at the end of this section for more information.

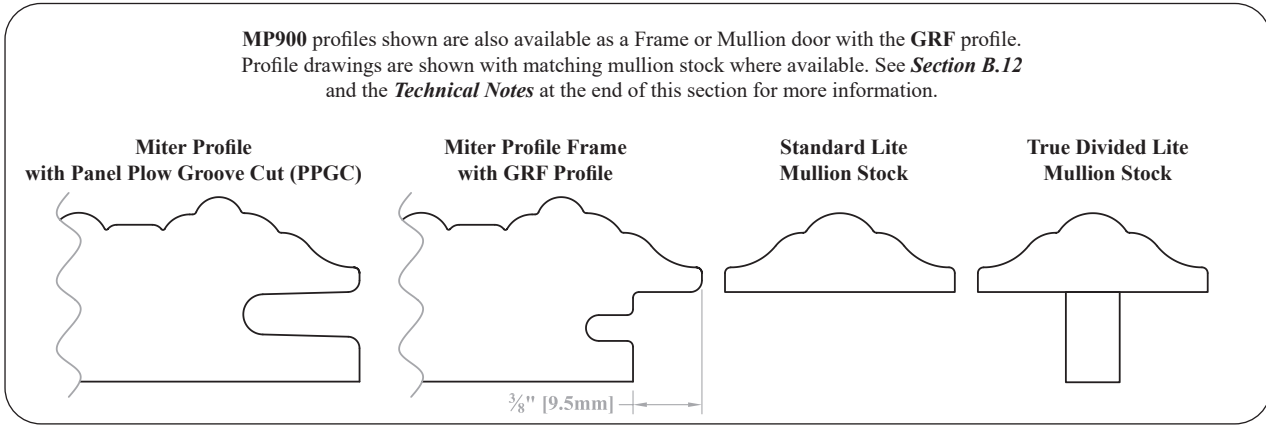

MP900 Family

Center Stiles & Rails will look like these profiles.

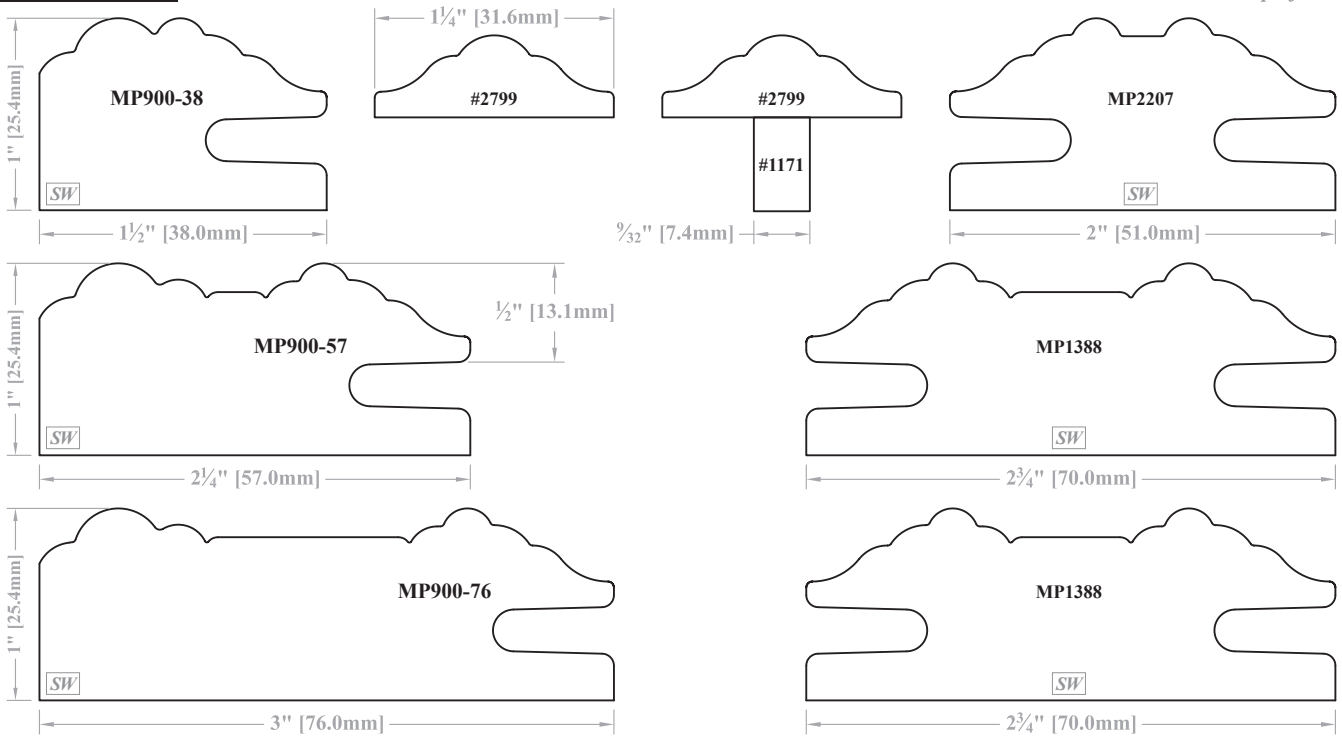

[SW] = Available in Solid Wood.

► **For PRICING** ► See **Section E.11** in our current Wholesale Pricing Catalog.

Mitered Stile & Rail Profiles with Matching Mullion Stock

MP901 Family

Center Stiles & Rails will look like these profiles.

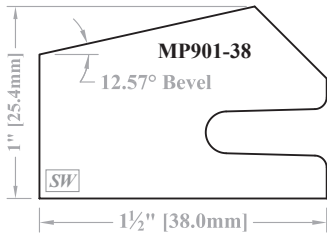

Matching Mullion Stock is not available for any of these profiles.

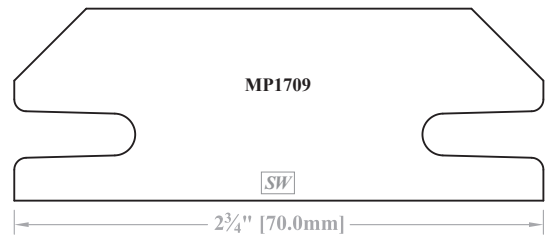
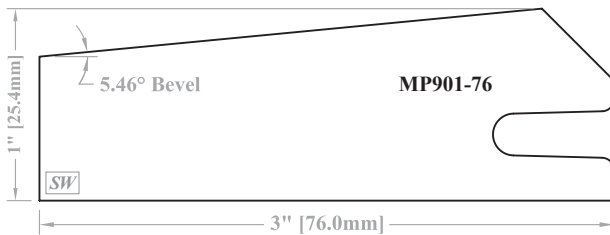
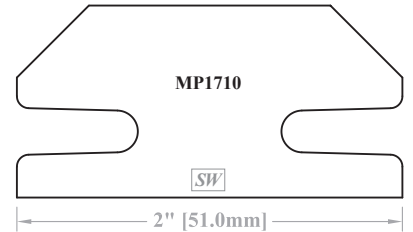
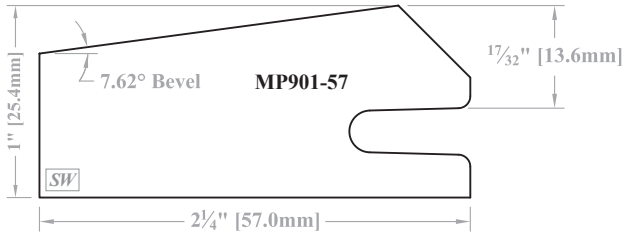
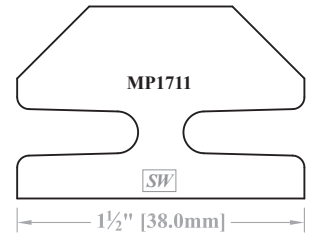

MP902 Family

Center Stiles & Rails will look like these profiles.

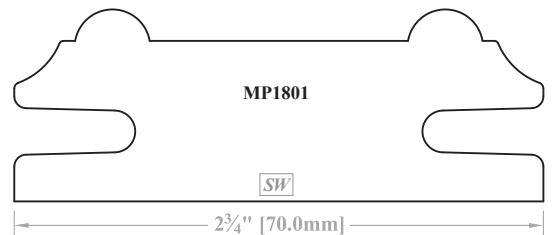
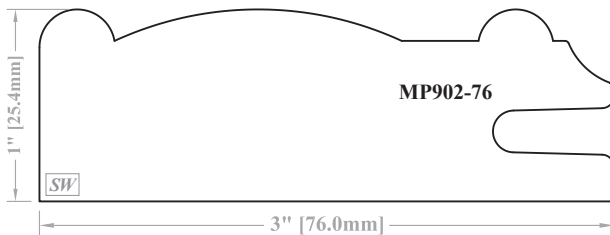
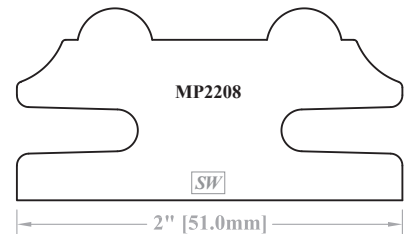
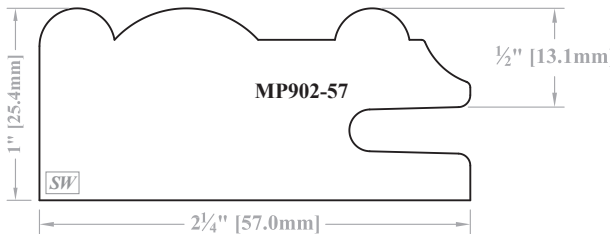
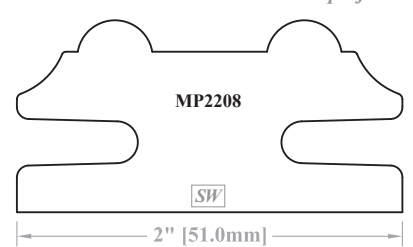
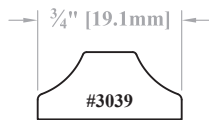
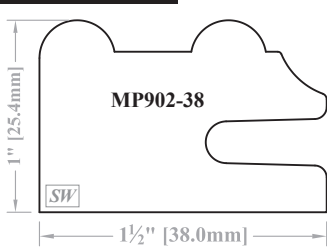

SW = Available in Solid Wood.

► For PRICING ► See Section E.11 in our current Wholesale Pricing Catalog.

E

Mitered Stile & Rail Profiles with Matching Mullion Stock

MP903 Family

Center Stiles & Rails will look like these profiles.

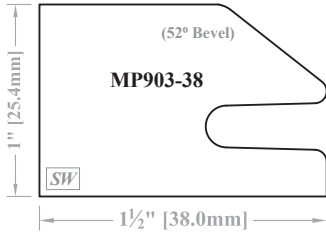

Matching Mullion Stock is not available for any of these profiles.

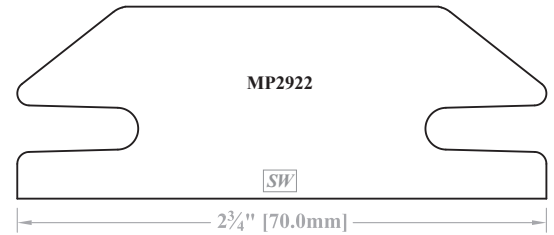
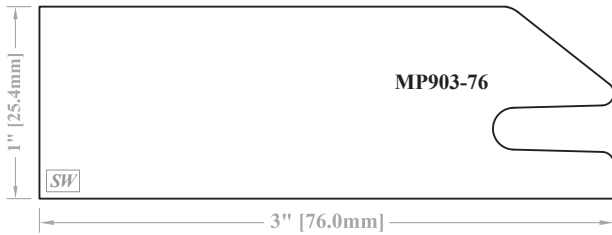
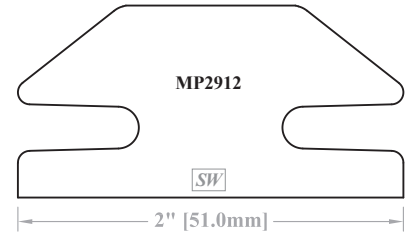
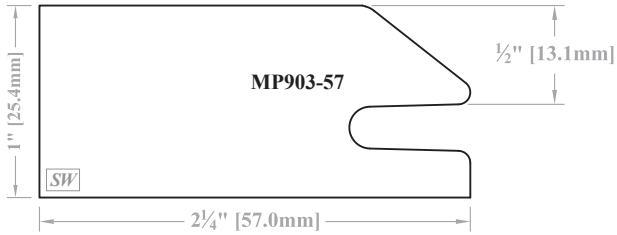
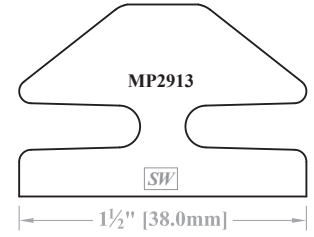

SW = Available in Solid Wood.

► For PRICING ► See Section E.11 in our current Wholesale Pricing Catalog.

Ordering & Pricing Notes: MP900 Series Miter Door & Drawer Front Profiles

Ordering Guidelines

1	Order Forms	Applicable order forms will include spaces to indicate your chosen profiles.
Pricing		
1	Pricing	Please see <i>Section E.11</i> of our current Wholesale Pricing Catalog.

Technical Notes: MP900 Series Miter Door & Drawer Front Profiles

Cabinet Door & Drawer Front Options (Chapter B)

1	Mitered Frame or Mullion Doors	All of the mitered profiles shown in this catalog are also available with the GRF profile. When ordering, please indicate whether the door is a frame or mullion. If a mullion, please indicate the lite pattern and number of lites. <i>Not all mitered profiles are available with mullions.</i>
---	--------------------------------	---

Design Options (Chapter G)

1	“Mitered” Stile and Rail Stock (Part #SRP100)	Mitered stile & rail stock is produced and priced the same as Traditional stile & rail stock with an outside edge. Available in 8' [2438.4mm], Random Length and Cut to Length sizes. See <i>Section G.16</i> for additional information and pricing guidelines. <ul style="list-style-type: none"> To order please use <i>E•Z Order Form #9 - Face Frame</i> and Part #SRP100.
---	---	--

Functional Options (Chapter F)

1	1½" [38.1mm] Wide Profiles	Hinge boring is <i>not available</i> for any of the 1½" [38.1mm] wide miter profiles.
2	Hinge Boring & Finger Pulls	Not all hinges are compatible with 1" or greater door thicknesses. Please consult the specifications for your chosen hinges before selecting hinge boring options. Please reference the Miter Compatibility chart for more information. Compatibility charts can be found on our website under Resources > Technical Information > Compatibility Charts .

General Information (Chapter A)

1	Ready to Assemble (RTA)	RTA is available as an option.
---	-------------------------	--------------------------------

Material Options

1	Material Options	 = Profile is available on products made from solid wood.
---	------------------	--

Miscellaneous

1	Center Stile and Rail Construction	All center stiles & rails will be haunched into the outside stiles & rails creating a mitered joint where they are conjoined.
---	------------------------------------	---

Profile Options (Chapter E)

1	Center Panel Profile Options	The center panel profiles designed for use with Old World stile & rail profiles can be found in <i>Sections E.13</i> and <i>E.14</i> . <ul style="list-style-type: none"> Old World stile & rail profiles from this section are not compatible with traditional center panel profiles from <i>Section E.12</i>. See <i>page A.4.4</i> for typical construction of a 1" [25.4mm] thick Old World door.
---	------------------------------	---

Sizes/Dimensions

1	Profile Drawings	All stile & rail and mullion stock drawings are to scale.
2	Thickness	Old World stile & rail profiles are available in 1" [25.4mm], 1½" [28.6mm] and 1¼" [31.8mm] thicknesses.
3	Minimum Sizes	All mitered door and drawer front minimum sizes are calculated based on 2¼" [57.2mm] wide profiles. <ul style="list-style-type: none"> If using a 3" [76.2mm] wide profile, please add 1½" [38.1mm] to the published minimum door size. If using a 1½" [38.1mm] wide profile, deduct 1½" [38.1mm] from the published minimum size.

Mitered Mortise & Tenon Joinery - MP900 Series - END

► For PRICING ► See Section [E.11](#) in our current Wholesale Pricing Catalog.

"Traditional" Raised Panels

E

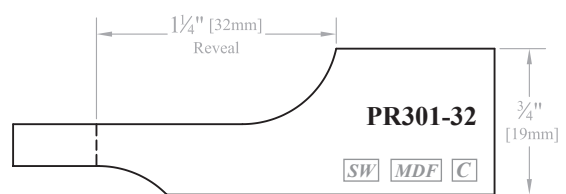
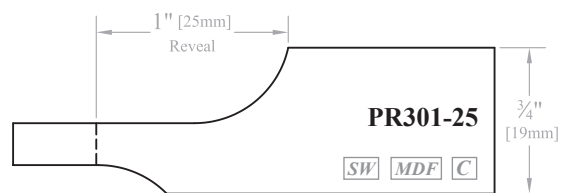
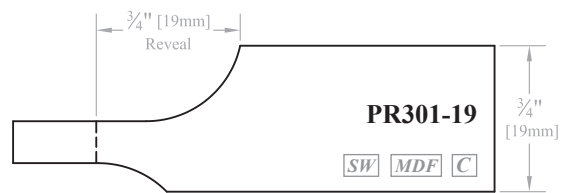
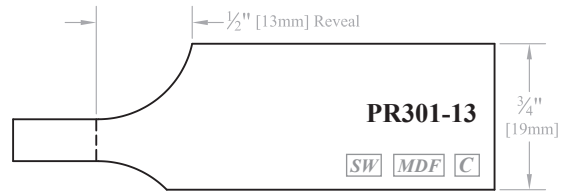
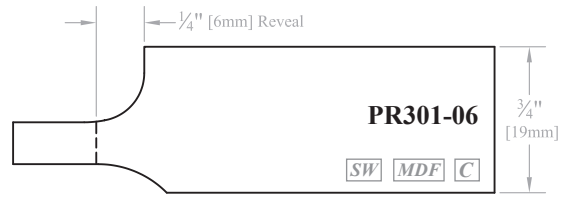
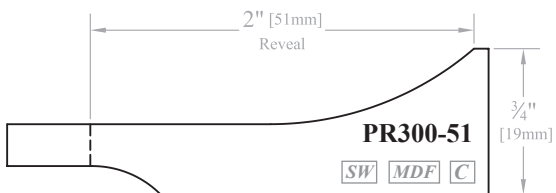
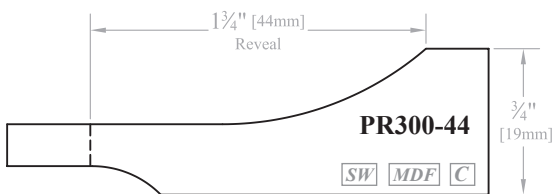
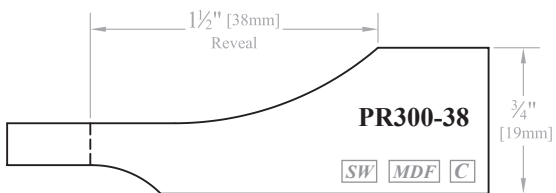
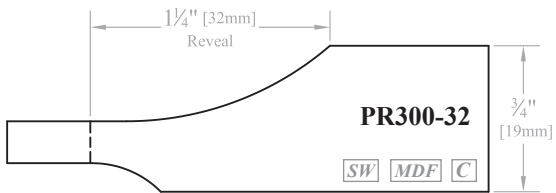
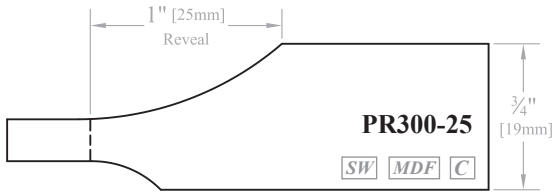
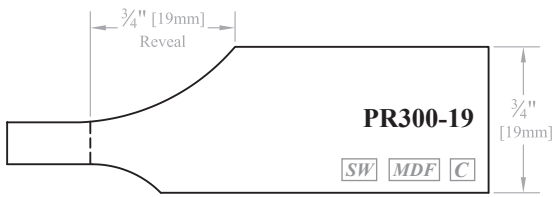

"Light Intensity" is the only glaze intensity option available when using PR301-06 panel profile due to space constraints in the profiled area.

[SW] = Available in Solid Wood.

[MDF] = Available in Medium Density Fiberboard (MDF).

[C] = Available for Convex/Concave products.

► For PRICING ► See Section E.12 in our current Wholesale Pricing Catalog.



"Traditional" Raised Panels

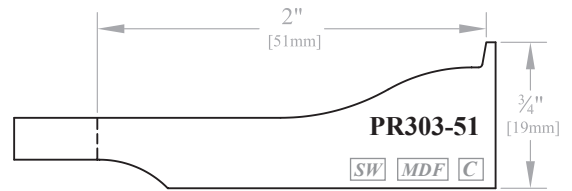
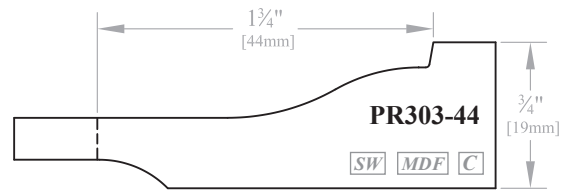
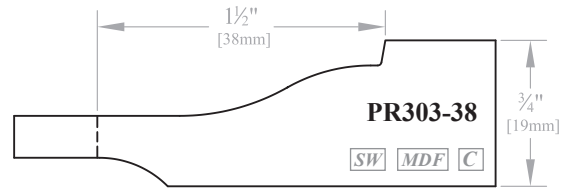
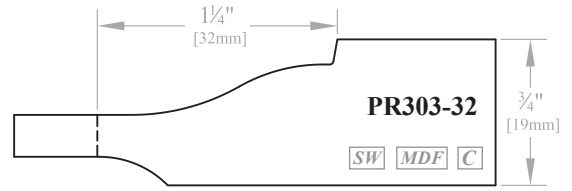
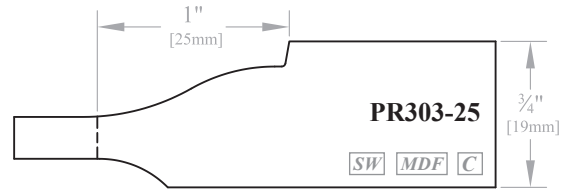
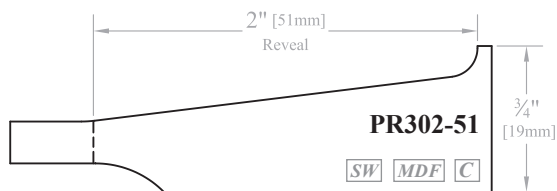
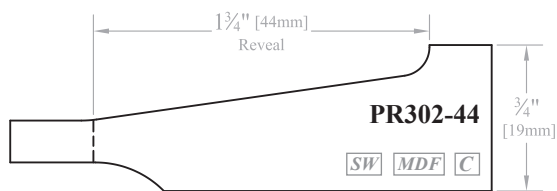
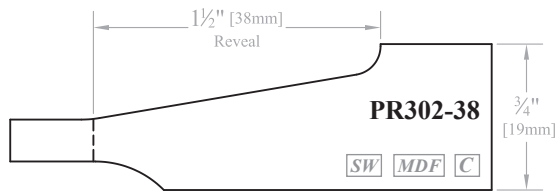
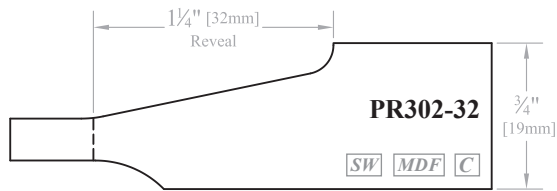
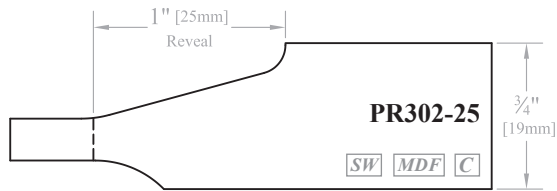
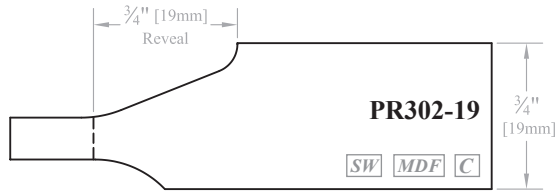
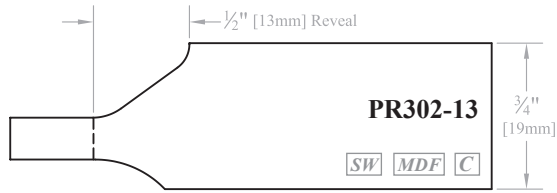

E

[SW] = Available in Solid Wood.

[MDF] = Available in Medium Density Fiberboard (MDF).

[C] = Available for Convex/Concave products.



"Traditional" Raised Panels

E

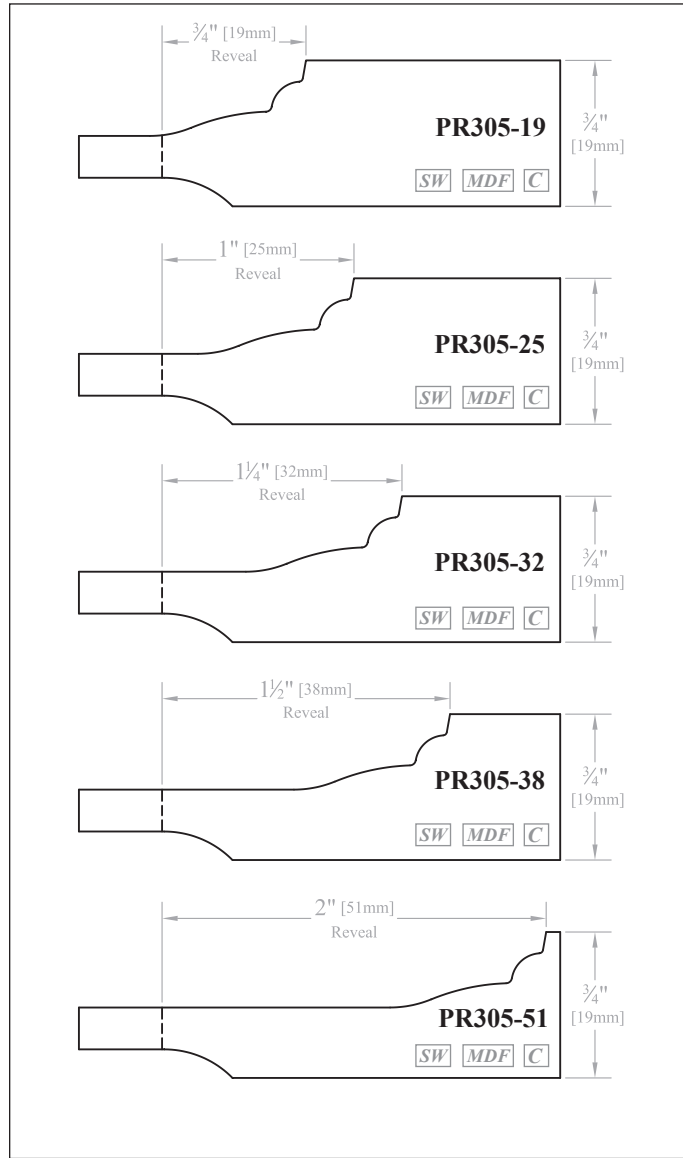
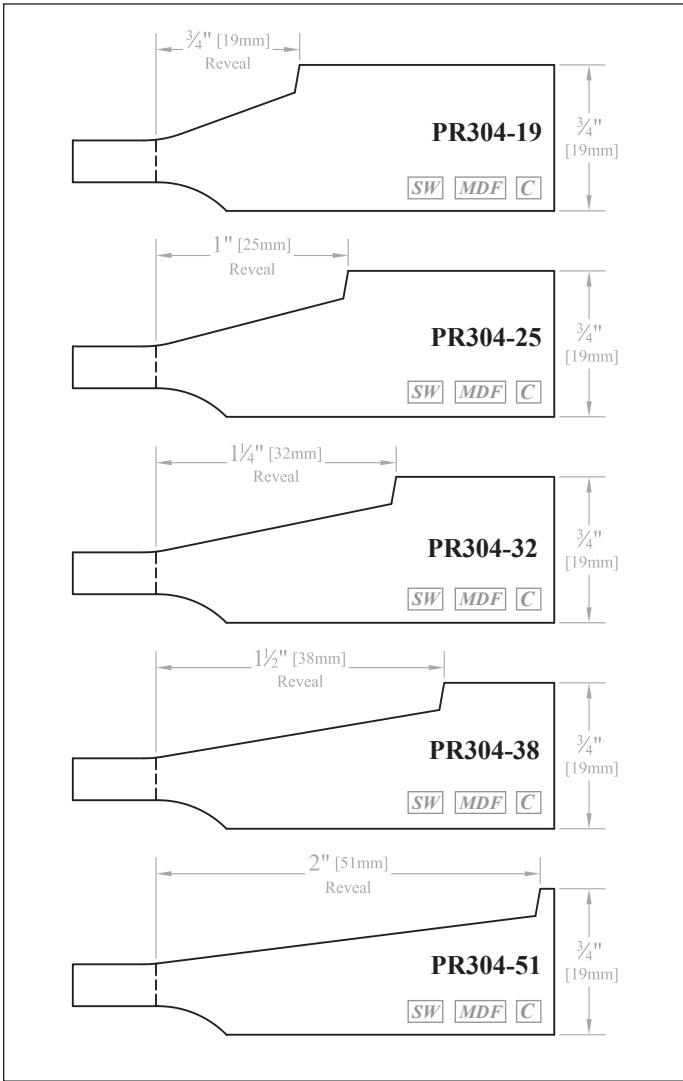

SW = Available in Solid Wood. **MDF** = Available in Medium Density Fiberboard (MDF). **C** = Available for Convex/Concave products.

► **For PRICING** ► See Section **E.12** in our current Wholesale Pricing Catalog.

"Traditional" Raised Panels

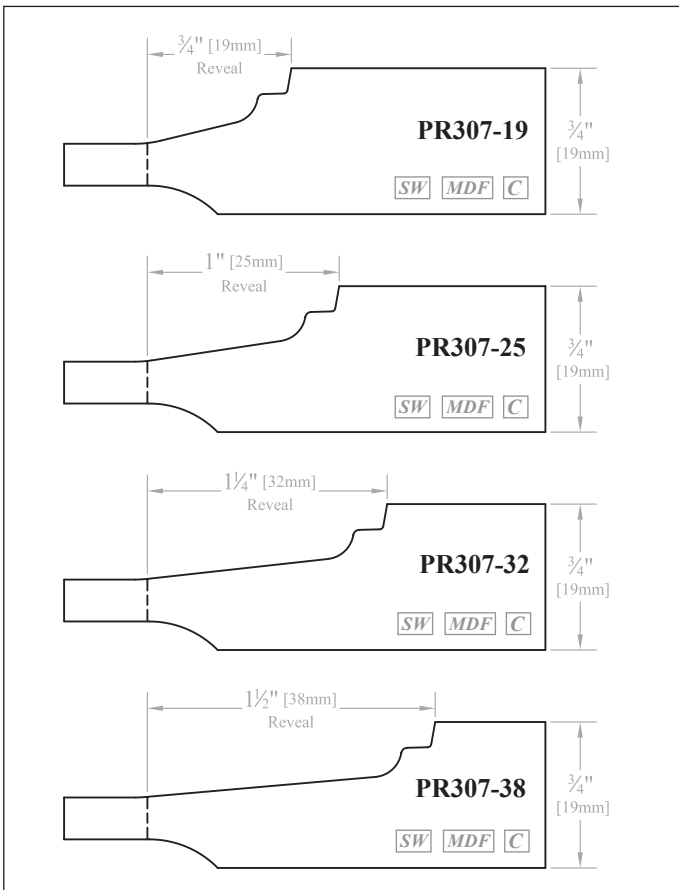
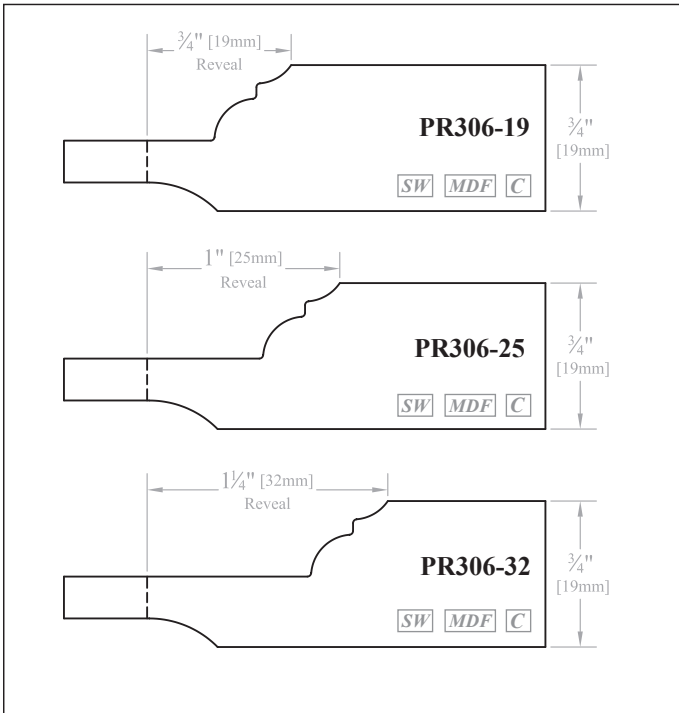

"Light Intensity" is the only glaze intensity option available when using PR308-03, PR308-05 & PR308-06 panel profile due to space constraints in the profiled area.

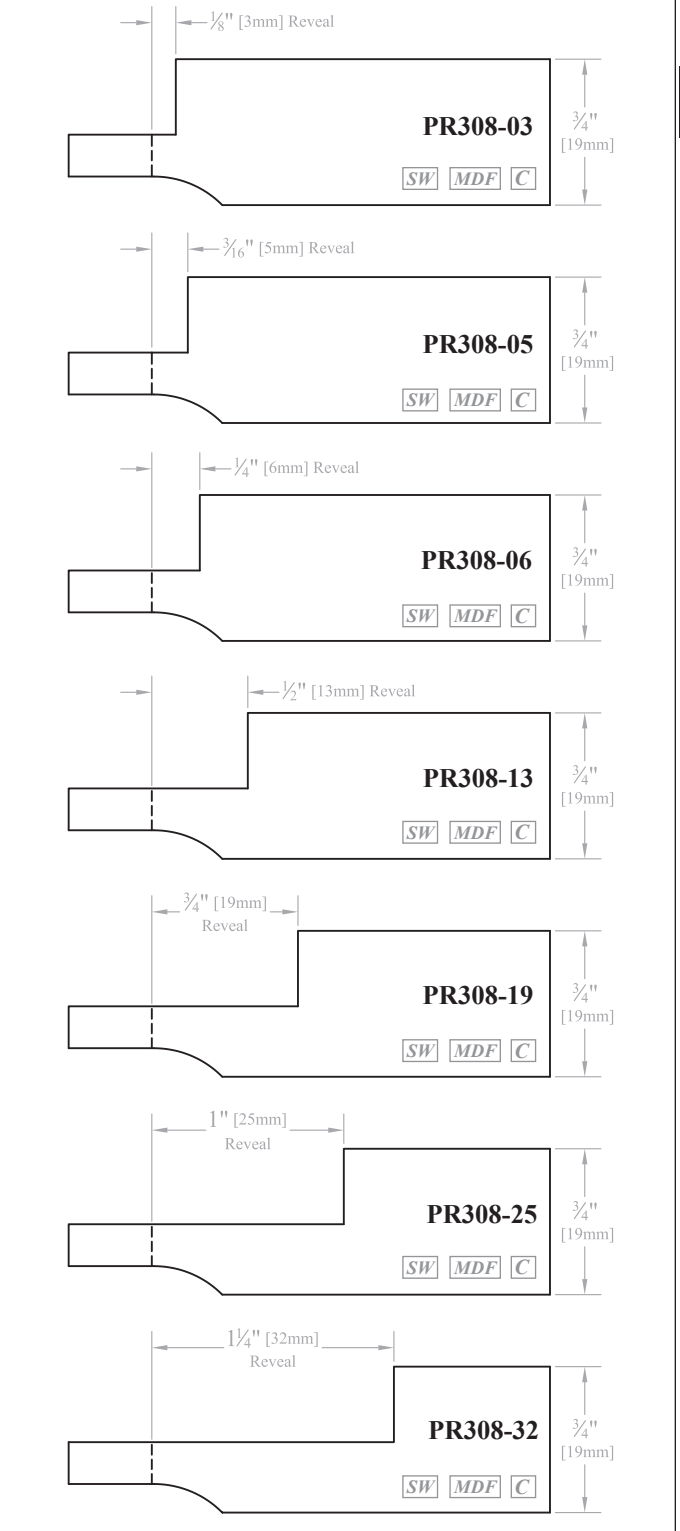

SW = Available in Solid Wood.

MDF = Available in Medium Density Fiberboard (MDF).

C = Available for Convex/Concave products.

► For PRICING ► See Section E.12 in our current Wholesale Pricing Catalog.

"Traditional" Raised Panels

E

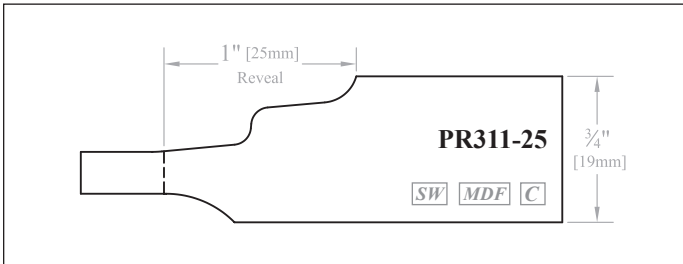
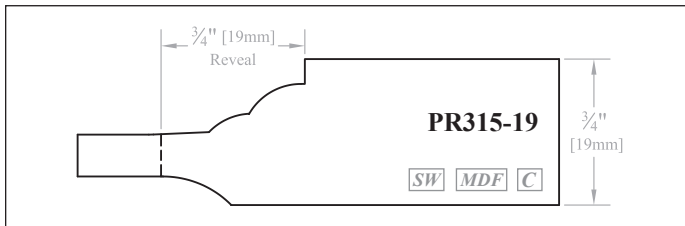
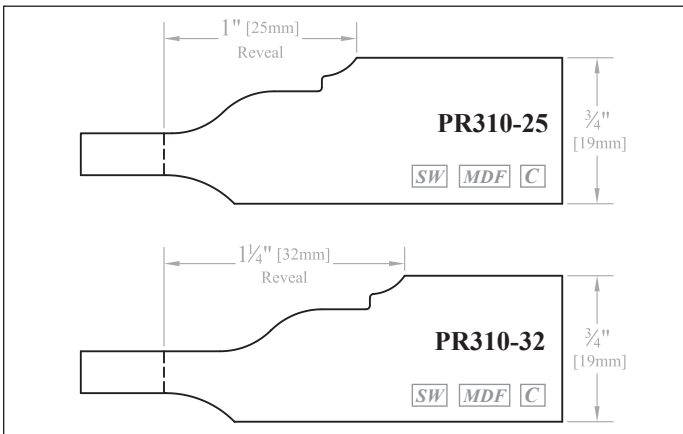
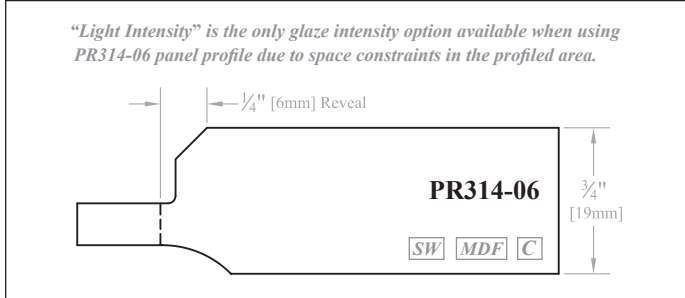
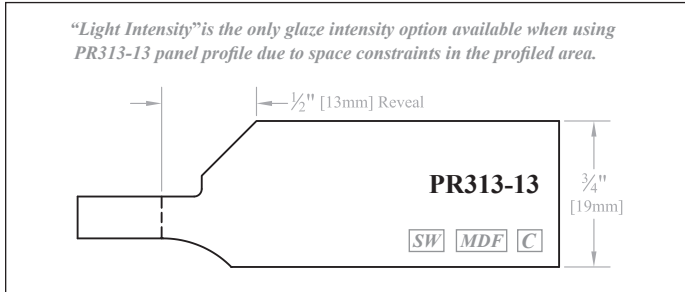
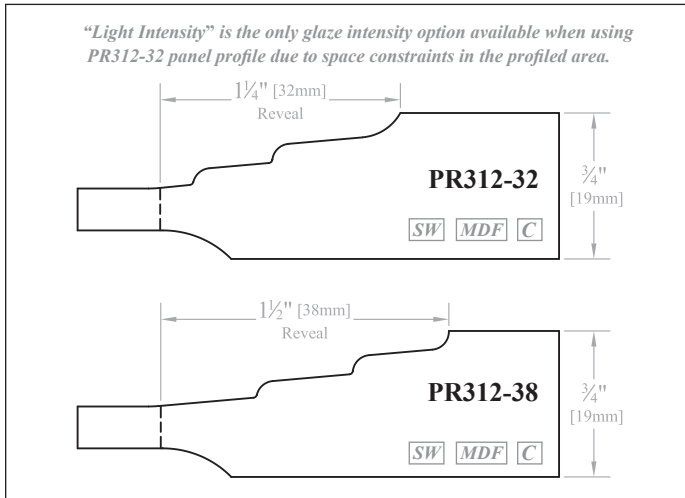
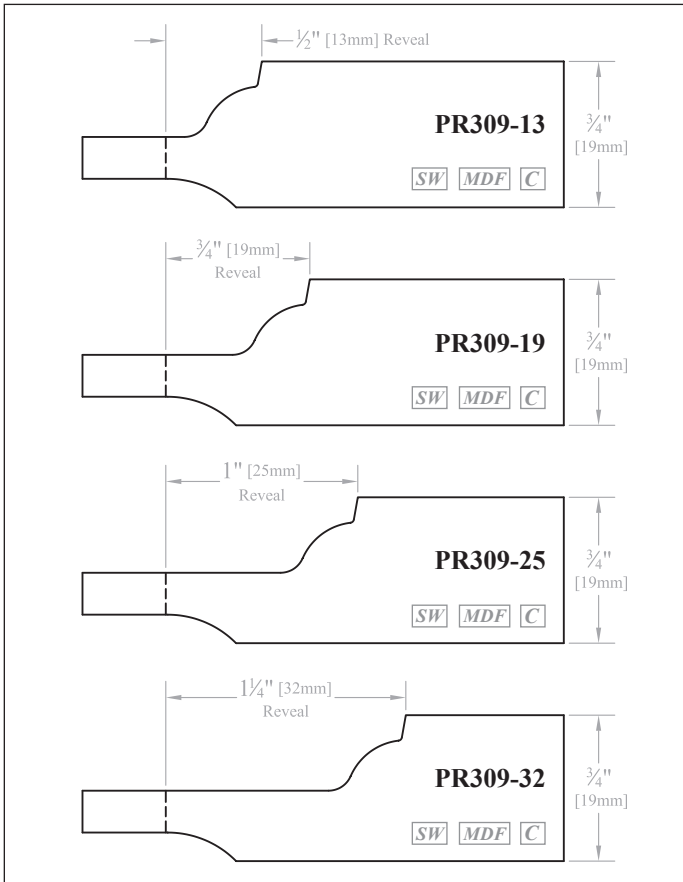

SW = Available in Solid Wood. **MDF** = Available in Medium Density Fiberboard (MDF). **C** = Available for Convex/Concave products.

► **For PRICING** ► See Section *E.12* in our current Wholesale Pricing Catalog.

"Traditional" Raised Panels

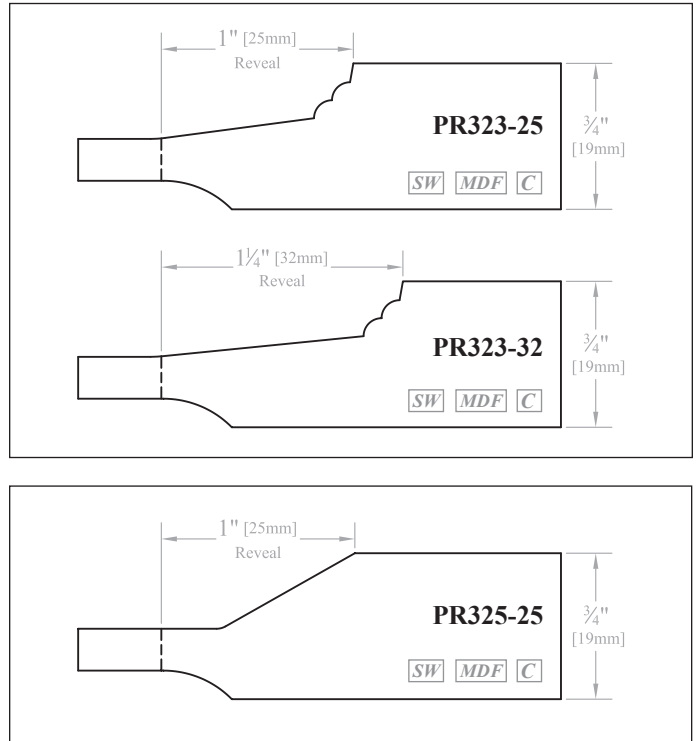
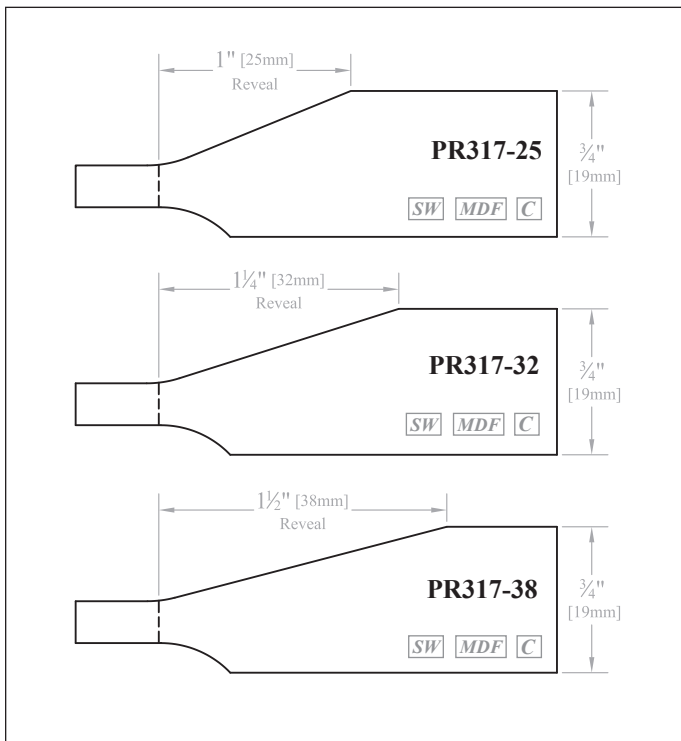
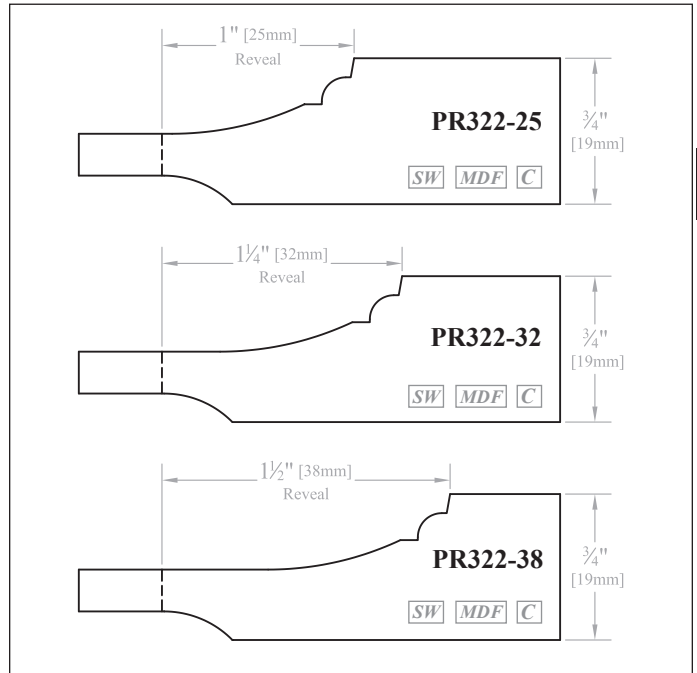
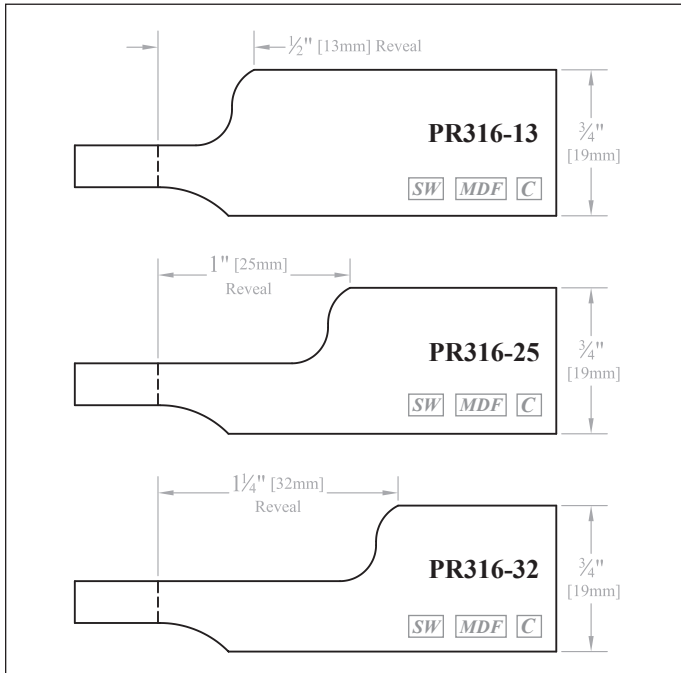

E

SW = Available in Solid Wood. MDF = Available in Medium Density Fiberboard (MDF). C = Available for Convex/Concave products.

► For PRICING ► See Section E.12 in our current Wholesale Pricing Catalog.

"Traditional" Raised Panels

E

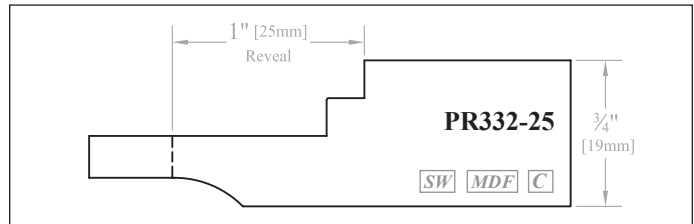
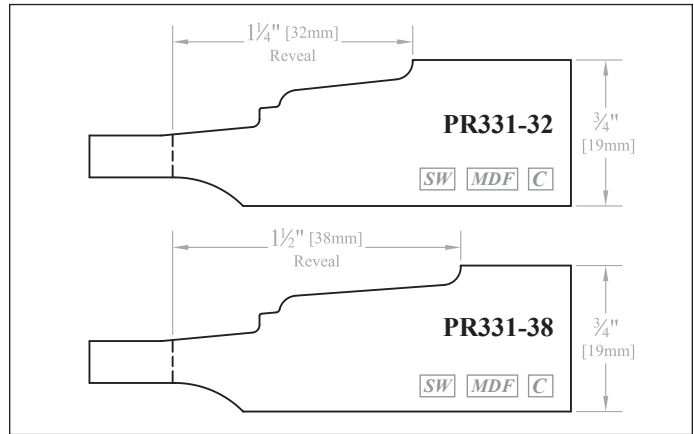
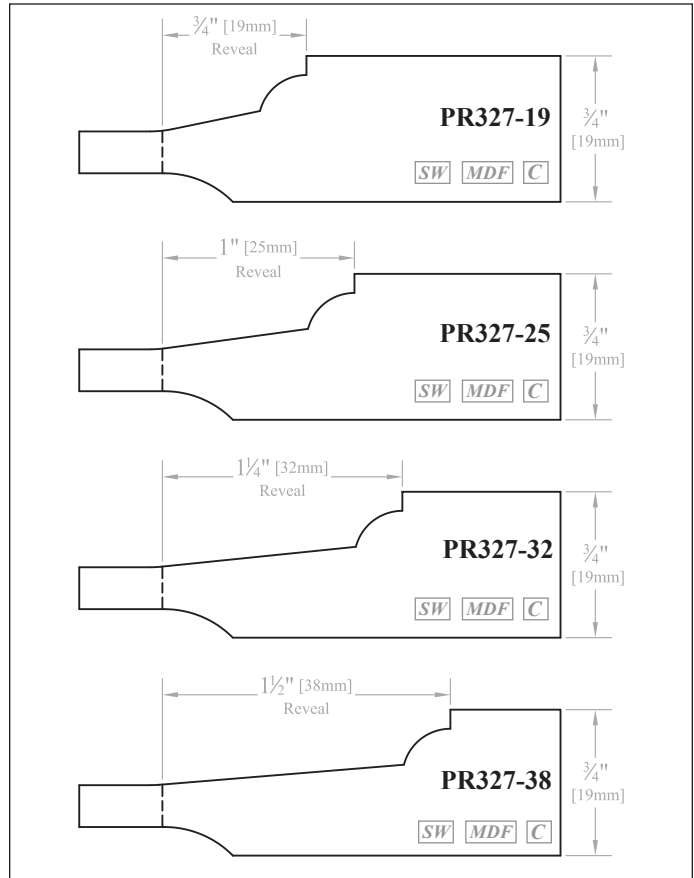
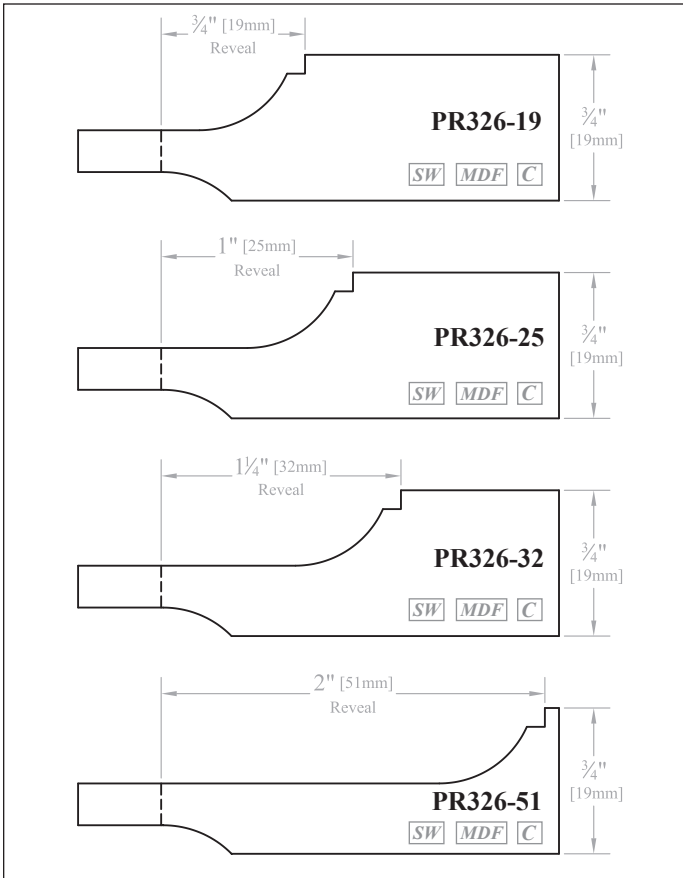

SW = Available in Solid Wood. MDF = Available in Medium Density Fiberboard (MDF). C = Available for Convex/Concave products.

► For PRICING ► See Section E.12 in our current Wholesale Pricing Catalog.

"Traditional" Raised Panels

"Light Intensity" is the only glaze intensity option available when using PR333-10 panel profile due to space constraints in the profiled area.

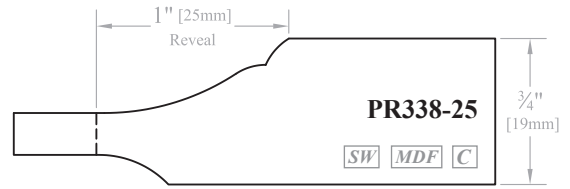
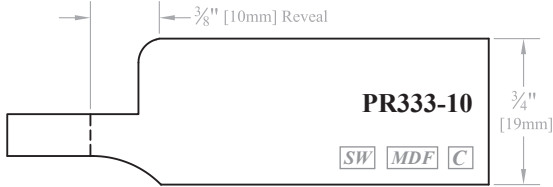

"Light Intensity" is the only glaze intensity option available when using PR334-25 panel profile due to space constraints in the profiled area.

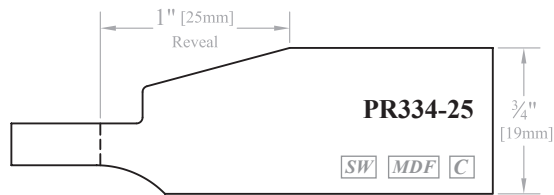

"Light Intensity" is the only glaze intensity option available when using PR339-04 panel profile due to space constraints in the profiled area.

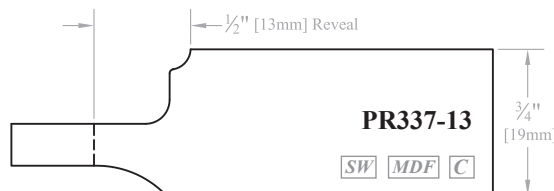
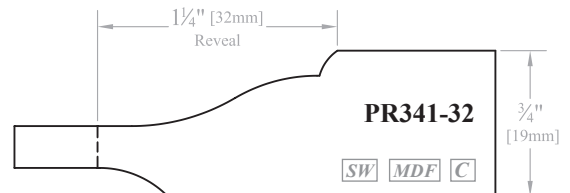
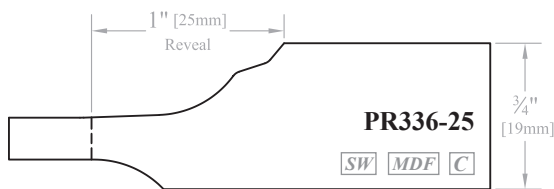
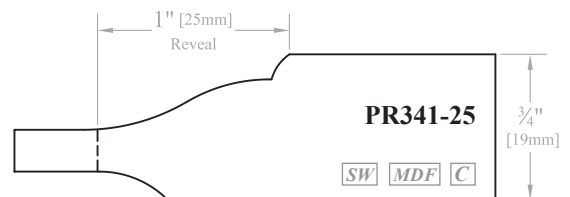
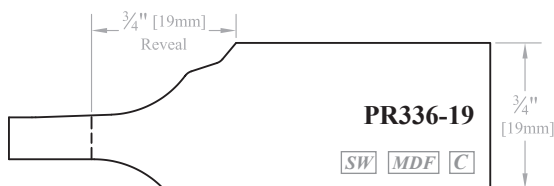
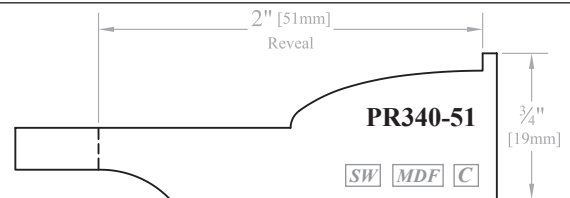
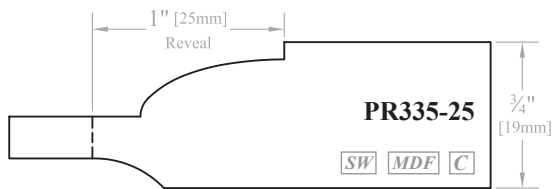
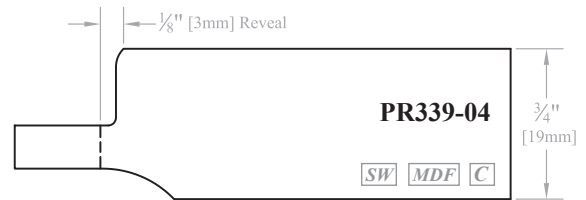

SW = Available in Solid Wood.

MDF = Available in Medium Density Fiberboard (MDF).

C = Available for Convex/Concave products.

► For PRICING ► See Section E.12 in our current Wholesale Pricing Catalog.

"Traditional" Raised Panels

E

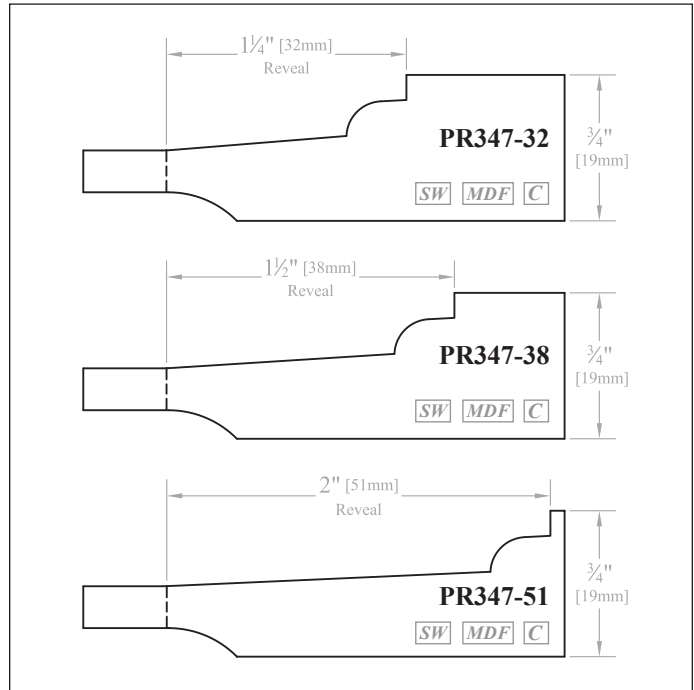
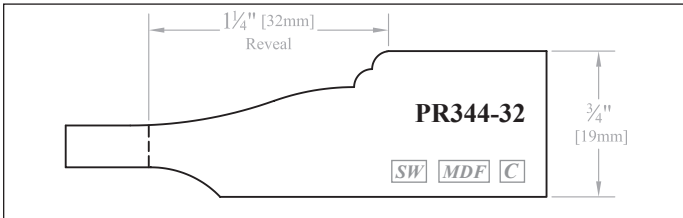
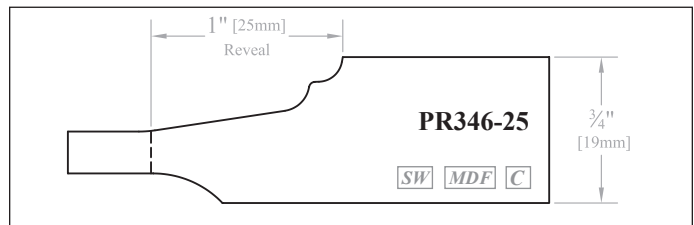
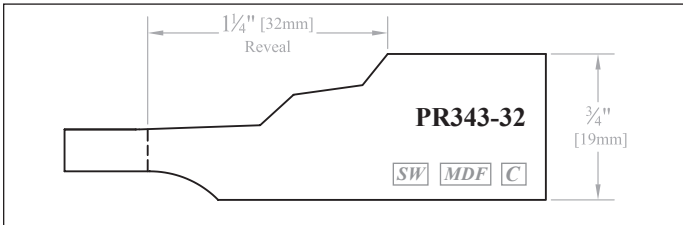
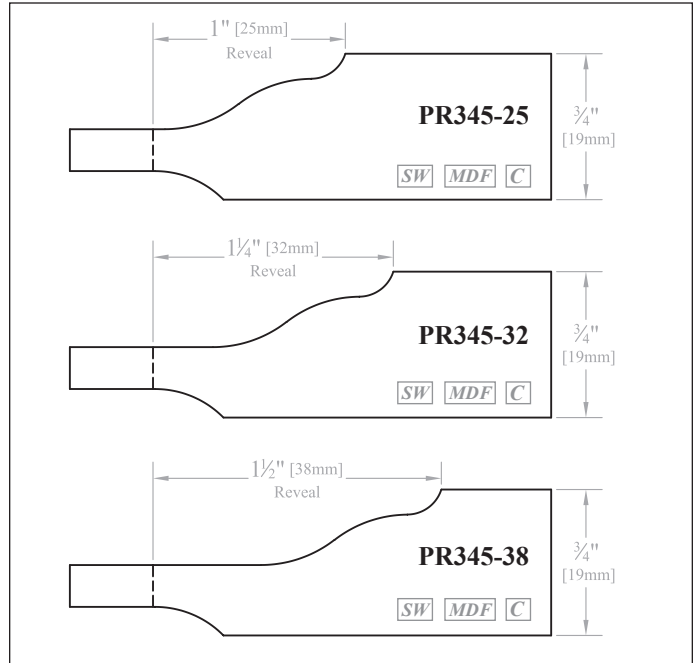
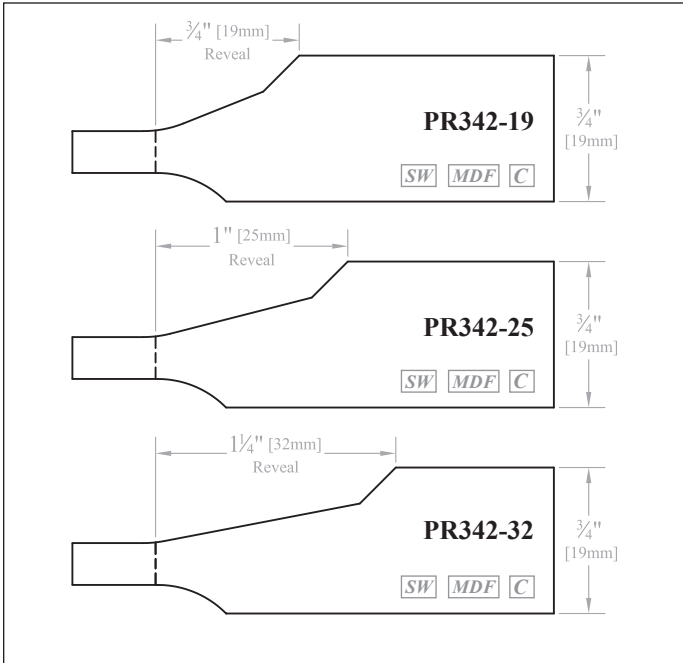

SW = Available in Solid Wood.

MDF = Available in Medium Density Fiberboard (MDF).

C = Available for Convex/Concave products.

► For PRICING ► See Section E.12 in our current Wholesale Pricing Catalog.



Recessed Raised Panels

• Center panel will **not** be flush with face of stiles and rails (except SR104, SR118, SR129, MP623 and MP624). See *Profile Options* notes in *Sections E.1, E.2, E.9* and *E.10* for more information.

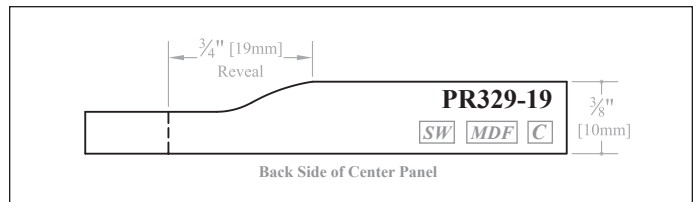
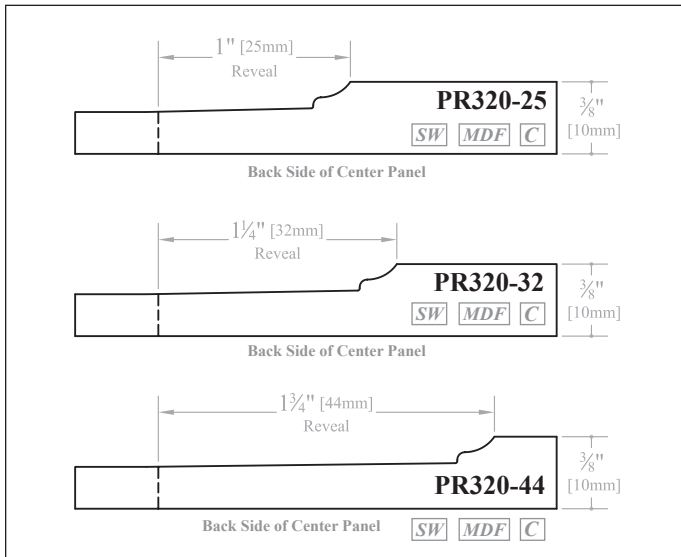
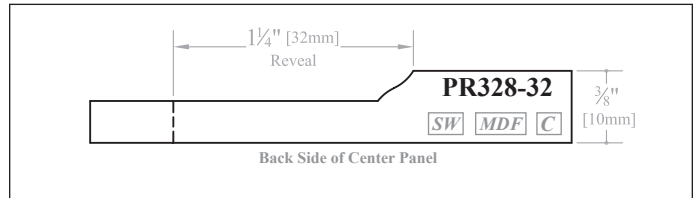
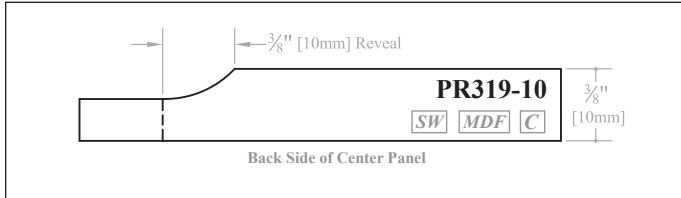
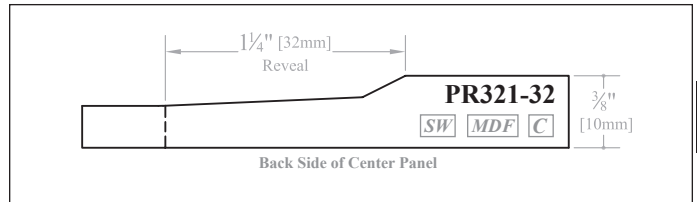
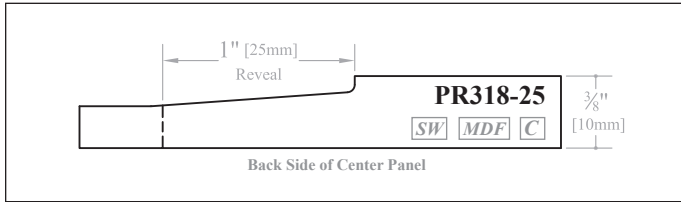

[SW] = Available in Solid Wood.

[MDF] = Available in Medium Density Fiberboard (MDF).

[C] = Available for Convex/Concave products.

► For PRICING ► See Section E.12 in our current Wholesale Pricing Catalog.

Profile Options

Center Panel - Standard Raised/Recessed Raised Panel

Ordering & Pricing Notes: Center Panel Profiles - Standard

Ordering Guidelines

1	Order Forms	Applicable order forms will include spaces to indicate your chosen profiles.
Pricing		
1	Pricing	Please see <i>Section E.12</i> of our current Wholesale Pricing Catalog.

Technical Notes: Center Panel Profiles - Standard

Cabinet Accessory Options (Chapter M)

1	Center Panels Only	See <i>Section M.16</i> for more information about Center Panels Only (CPO) in wood or MDF.
---	--------------------	--

Convex/Concave Options (Chapter D)

1	Curved Products	The <input type="checkbox"/> indicates profiles that are available for Convex/Concave products. For additional ordering guidelines, see <i>Chapter D</i> .
---	-----------------	--

Material Options



1	Material Options	<input type="checkbox"/> = Profile is available on products made from solid wood.
		<input type="checkbox"/> = Profile is available on products made from MDF (Medium Density Fiberboard).
2	MDF Center Panels	Available with all profiles when using paint grade stile & rail material.
		MDF raised center panels will be the same thickness as their solid wood equivalent.

Molding Options (Chapter N)

1	Applied Moldings	<p>Applied moldings cannot be attached to the face of solid wood center panels.</p> <ul style="list-style-type: none"> • See our website, Resources/Technical Information for the compatibility chart. • When using a flat panel or RVSCP-PR324 (Reversed Solid Center Panel), we suggest allowing 1" [25.4mm] of visible flat surface on the center of the panel to allow for attaching hardware. <ul style="list-style-type: none"> ◦ <i>It is the customer's responsibility to determine this sizing.</i>
---	------------------	--

Profile Options (Chapter E)

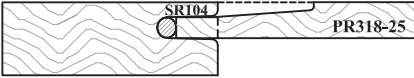
1	PR301-06, PR308-03, PR308-05, PR308-06, PR312-32, PR313-13, PR314-06, PR333-10, PR334-25, PR339-04	When using these center panel profile options, " Light Intensity " is the only glaze intensity option available, due to space constraints in the profiled area.
2	PR318-25, PR319-10, PR320-25, PR320-32, PR320-44, PR321-32, PR328-32, PR329-19	<p>Using the following stile and rail profiles will result in the face of the center panel being flush with the face of these Traditional stiles and rails:</p> <ul style="list-style-type: none"> • SR104, SR118, SR129, and the MP623 & MP624 mitered family profiles. • Using any other stile and rail profile will result in a recessed raised panel.

Sizes/Dimensions

1	Profile Drawings	<p>Most center panel profiles are drawn at a 3/8" [9.5mm] or 3/4" [19.1mm] thickness.</p> <p>Center panels on Convex/Concave doors will be 3/8" [16mm] thick and will be flush with stiles and rails on the face only.</p> <ul style="list-style-type: none"> • This does not apply to 3/8" [9.5mm] thick center panels or the RVSCP-PR324 (Reversed Solid Center Panel).
---	------------------	---

Center Panels - Standard Raised/Recessed Raised - END

► For PRICING ► See *Section E.12* in our current Wholesale Pricing Catalog.

Profile Options

Center Panels - Reversed Solid Center Panel (RVSCP-PR324)

The **RVSCP-PR324** (*Reversed Solid Center Panel*) was designed to provide an option for a solid wood center panel which gives the appearance of a flat panel on the face of the door. This option is ideal for cases where finish colors may vary between solid wood frames and veneered panels. Door thickness and placement of the Panel Plow Groove Cut in a frame will affect the center panel thickness and reveal when the center panel is recessed 0.5mm from the stiles & rails on the back side of the door. These illustrations demonstrate how various stile and rail profiles affect the thickness of the panel, resulting in a slight variance in the reveal on the back side of a door.

E

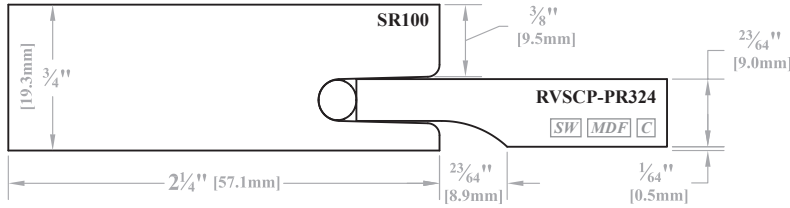

RVSCP-PR324 with 9.5mm PPGC Placement

- Construction: Traditional & Mitered M/T
- Stile & Rail Thickness: 3/4" [19.3mm]
- Panel Plow Groove Cut Placement: 3/8" [9.5mm]
- Panel Thickness: 23/64" [9.0mm]
- Panel Reveal on Backside of Door: 23/64" [8.9mm]
- Shown with SR100 Traditional stile & rail profile.

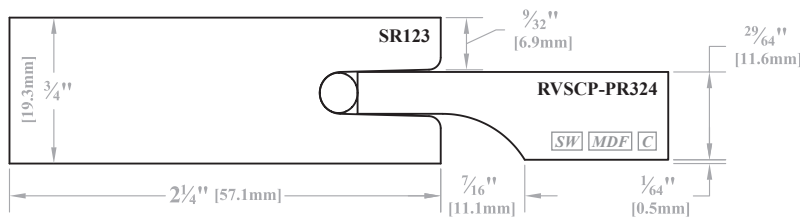

RVSCP-PR324 with 6.9mm PPGC Placement

- Construction: Traditional & Mitered M/T
- Stile & Rail Thickness: 3/4" [19.3mm]
- Panel Plow Groove Cut Placement: 7/16" [11.1mm]
- Panel Thickness: 29/64" [11.6mm]
- Panel Reveal on Backside of Door: 7/16" [11.1mm]
- Shown with SR123 Traditional stile & rail profile.

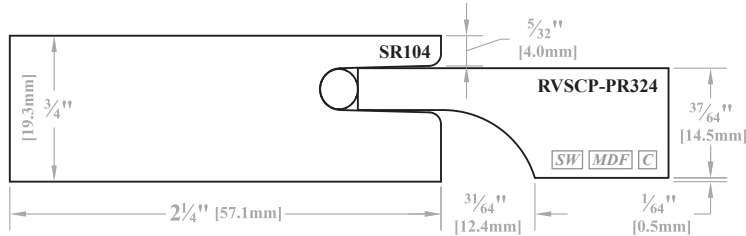

RVSCP-PR324 with 4.0mm PPGC Placement

- Construction: Traditional & Mitered M/T
- Stile & Rail Thickness: 3/4" [19.3mm]
- Panel Plow Groove Cut Placement: 5/32" [4.0mm]
- Panel Thickness: 37/64" [14.5mm]
- Panel Reveal on Backside of Door: 31/64" [12.4mm]
- Shown with SR104 Traditional stile & rail profile.

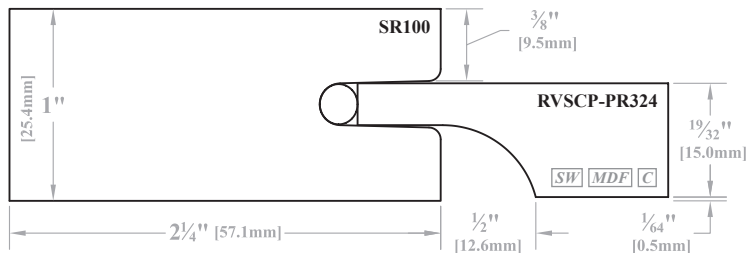

RVSCP-PR324 with 9.5mm PPGC Placement

- Construction: Traditional & Mitered M/T
- Stile & Rail Thickness: 1" [25.4mm]
- Panel Plow Groove Cut Placement: 3/8" [9.5mm]
- Panel Thickness: 19/32" [15.0mm]
- Panel Reveal on Backside of Door: 1/2" [12.6mm]
- Shown with SR100 Traditional stile & rail profile.

Continued on next page...

► For PRICING ► See Section E.13 in our current Wholesale Pricing Catalog.



RVSCP-PR324 with 6.9mm PPGC Placement

- Construction: Traditional & Mitered M/T
- Stile & Rail Thickness: 1" [25.4mm]
- Panel Plow Groove Cut Placement: $\frac{9}{32}$ " [6.9mm]
- Panel Thickness: $\frac{45}{64}$ " [17.7mm]
- Panel Reveal on Backside of Door: $\frac{33}{64}$ " [13.0mm]
- Shown with SR123 Traditional stile & rail profile.

RVSCP-PR324 with 4.0mm PPGC Placement

- Construction: Traditional & Mitered M/T
- Stile & Rail Thickness: 1" [25.4mm]
- Panel Plow Groove Cut Placement: $\frac{5}{32}$ " [4.0mm]
- Panel Thickness: $\frac{13}{16}$ " [20.6mm]
- Panel Reveal on Backside of Door: $\frac{33}{64}$ " [13.0mm]
- Shown with SR104 Traditional stile & rail profile.

RVSCP-PR324 with 13.1mm PPGC Placement

- Construction: Old World - Traditional & Mitered
- Stile & Rail Thickness: 1" [25.4mm]
- Panel Plow Groove Cut Placement: $\frac{33}{64}$ " [13.1mm]
- Panel Thickness: $\frac{29}{64}$ " [11.5mm]
- Panel Reveal on Backside of Door: $\frac{7}{16}$ " [11.1mm]
- Shown with SR195 Old World stile & rail profile.

RVSCP-PR324 with 13.1mm PPGC Placement

- Construction: Old World - Traditional & Mitered
- Stile & Rail Thickness: $1\frac{1}{8}$ " [28.6mm]
- Panel Plow Groove Cut Placement: $\frac{33}{64}$ " [13.1mm]
- Panel Thickness: $\frac{37}{64}$ " [14.7mm]
- Panel Reveal on Backside of Door: $\frac{31}{64}$ " [12.5mm]
- Shown with SR195 Old World stile & rail profile.

RVSCP-PR324 with 13.1mm PPGC Placement

- Construction: Old World - Traditional & Mitered
- Stile & Rail Thickness: $1\frac{1}{4}$ " [31.8mm]
- Panel Plow Groove Cut Placement: $\frac{33}{64}$ " [13.1mm]
- Panel Thickness: $\frac{45}{64}$ " [17.9mm]
- Panel Reveal on Backside of Door: $\frac{33}{64}$ " [13.0mm]
- Shown with SR195 Old World stile & rail profile.

Continued on next page...

► For PRICING ► See Section E.13 in our current Wholesale Pricing Catalog.

Profile Options

Center Panels - Reversed Solid Center Panel (RVSCP-PR324)

Ordering & Pricing Notes: Center Panel Profiles - RVSCP-PR324 (Reversed Solid Center Panel)

Ordering Guidelines

1	Order Forms	Applicable order forms will include spaces to indicate your chosen profiles.
Pricing		
1	Pricing	Please see <i>Section E.13</i> of our current Wholesale Pricing Catalog .

Technical Notes: Center Panel Profiles - RVSCP-PR324 (Reversed Solid Center Panel)

Material Options

1	Material Options	[SW] = Profile is available on products made from solid wood.
		[MDF] = Profile is available on products made from MDF (Medium Density Fiberboard).
2	MDF - MR, Raw	<p>RVSCP-PR324 is also available in MDF - MR (Moisture Resistant), Raw.</p> <ul style="list-style-type: none"> • Available in all stile & rail thickness / panel plow groove cut (PPGC) placement combinations except the following: <ul style="list-style-type: none"> ◦ 1" stile & rail thickness with 6.9mm PPGC placement. ◦ 1 1/4" stile & rail thickness with 13.1mm PPGC placement.

Molding Options (Chapter N)

1	Applied Moldings	<p>Applied moldings cannot be attached to the face of solid wood center panels. See the compatibility chart on our website under: Resources / Technical Information.</p> <ul style="list-style-type: none"> • When using a flat or RVSCP-PR324 (Reversed Solid Center Panel), we suggest allowing 1" [25.4mm] of visible flat surface on the center of the panel to allow for attaching hardware. • <i>It is the customer's responsibility to determine this sizing.</i>
---	------------------	---

Profile Options (Chapter E)

1	RVSCP-PR324 Center Panel Profile	This RVSCP-PR324 (Reversed Solid Center Panel) profile was designed to simulate a flat center panel in a door while providing you with a solid wood center panel.
		Designed to be recessed 0.5mm [$\approx 1/64"$] on the back side of the door when used with the specific Traditional, Mitered and Old World stile and rail profiles. Please reference illustrations and profile options.
		When ordering an MDF center panel, the panel will be recessed 0.5mm [$\approx 1/64"$] on the back side of the door, the same as solid wood.
2	1/4" Thick Flat Panel	Please see <i>Section A.4</i> and <i>B.3</i> for more information on 1/4" veneer flat center panels.

Center Panel - Reverse Solid Center Panel (RVSCP-PR324) - END

► For PRICING ► See Section [E.13](#) in our current Wholesale Pricing Catalog.

Old World Raised Panels

E

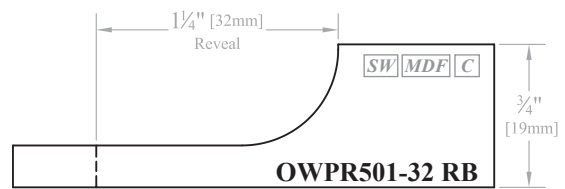
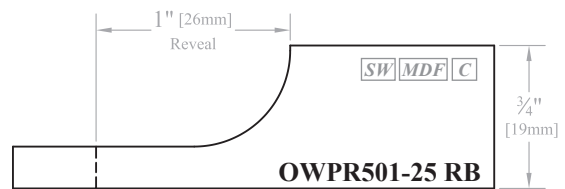
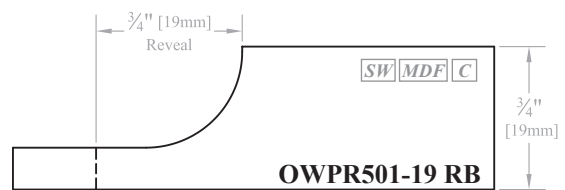
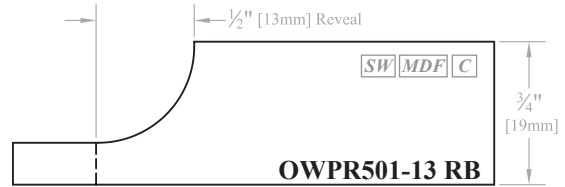
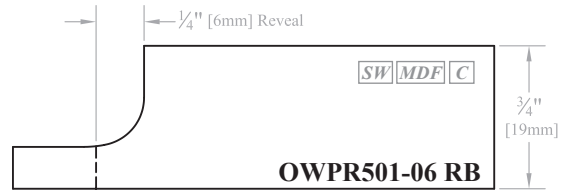
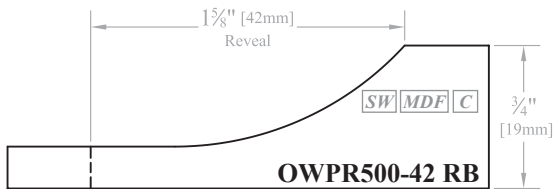
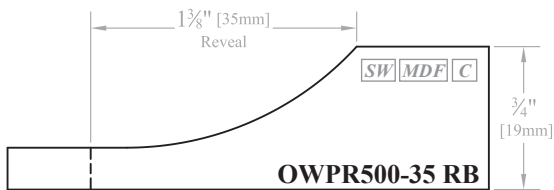
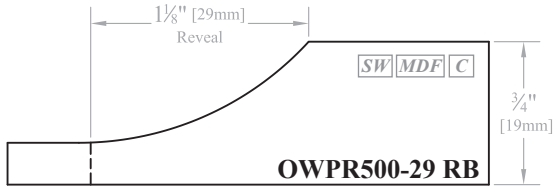
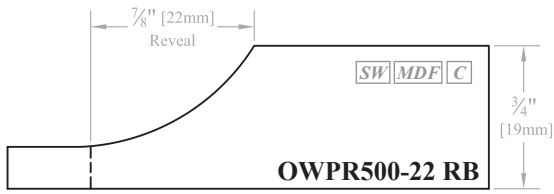

"Light Intensity" is the only glaze intensity option available when using OWPR501-06 RB panel profile due to space constraints in the profiled area.

SW = Available in Solid Wood **C** = Available for Convex/Concave Products **MDF** = Available in Medium Density Fiberboard (MDF) **OW** = Old World **RB** = Recessed Back

► For PRICING ► See Section E.14 in our current Wholesale Pricing Catalog.



Old World Raised Panels

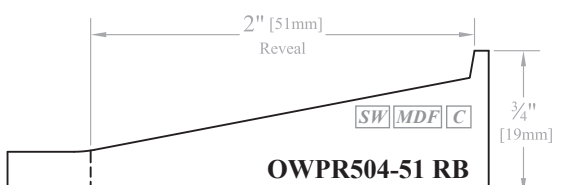
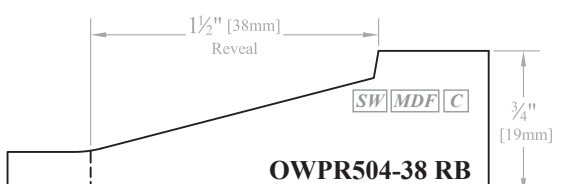
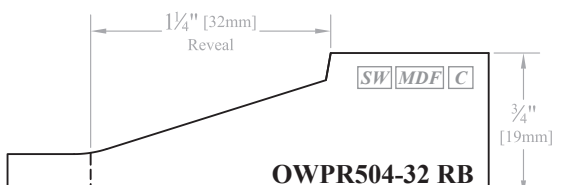
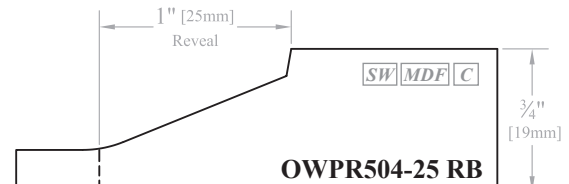
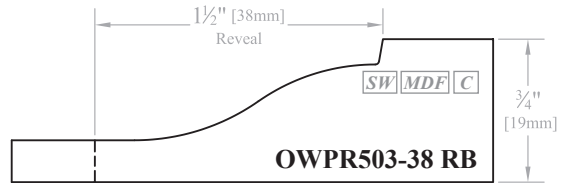
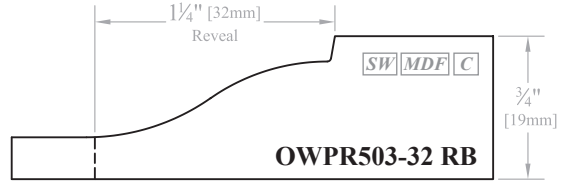
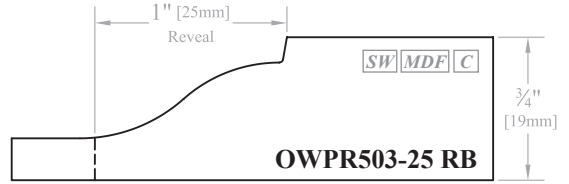
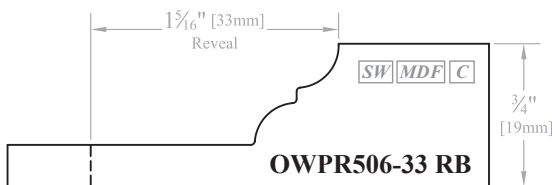
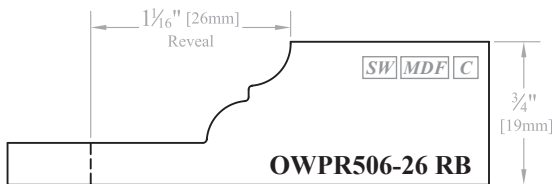
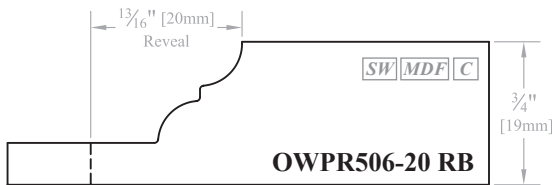
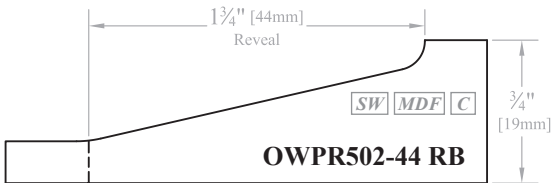
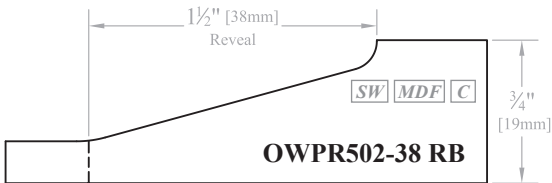
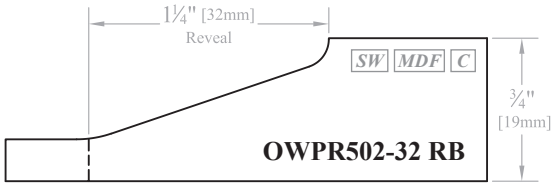
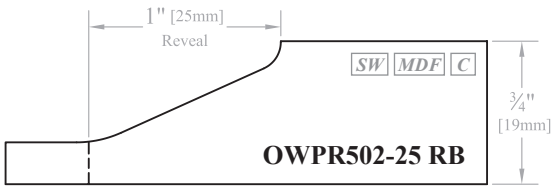

SW = Available in Solid Wood C = Available for Convex/Concave Products MDF = Available in Medium Density Fiberboard (MDF) OW = Old World RB = Recessed Back

► For PRICING ► See Section E.14 in our current Wholesale Pricing Catalog.

Profile Options

Center Panel - Old World Raised

"Old World" Raised Panels

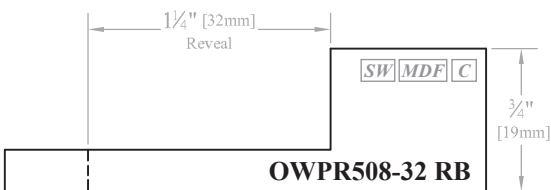
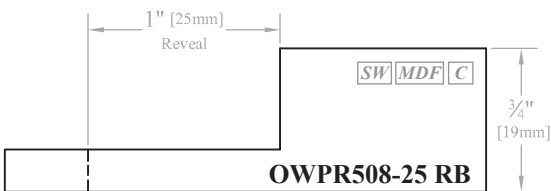
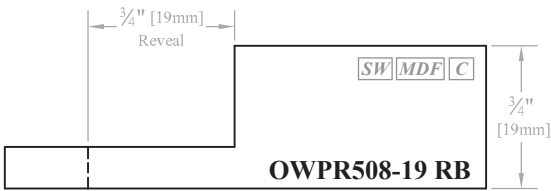
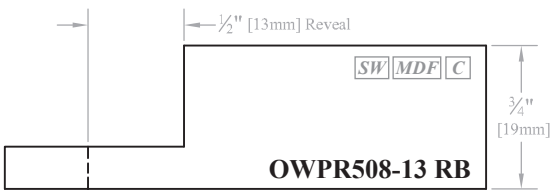
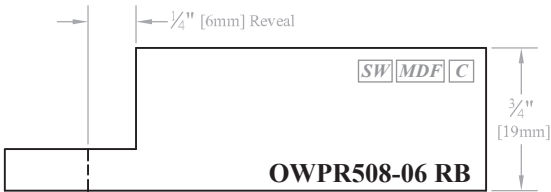
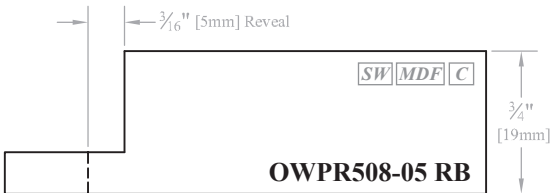
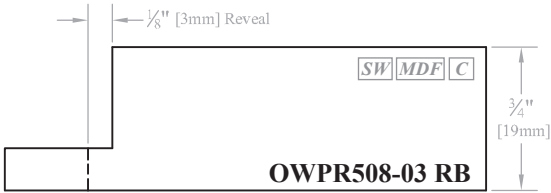

"Light Intensity" is the only glaze application available when using OWPR508-06 RB, OWPR508-05 RB and OWPR508-03 RB panel profiles due to space constraints in the profiled area.

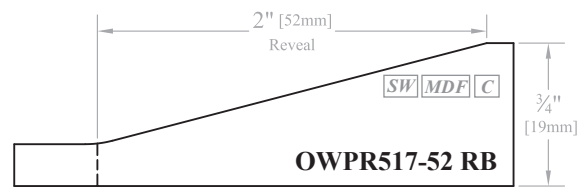
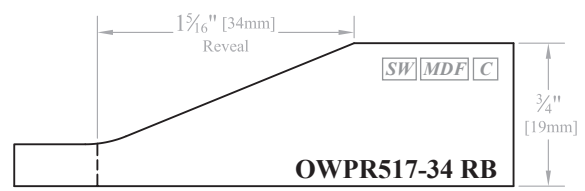
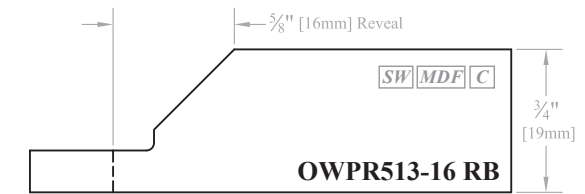
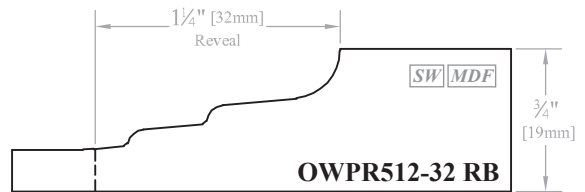
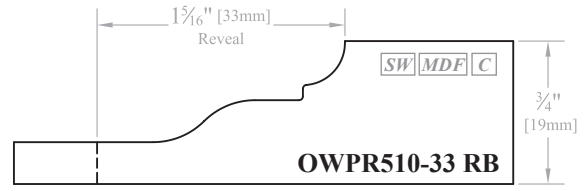
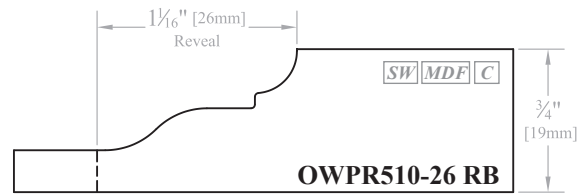

SW = Available in Solid Wood **C** = Available for Convex/Concave Products **MDF** = Available in Medium Density Fiberboard (MDF) **OW** = Old World **RB** = Recessed Back

► For PRICING ► See Section E.14 in our current Wholesale Pricing Catalog.



Old World Raised Panels

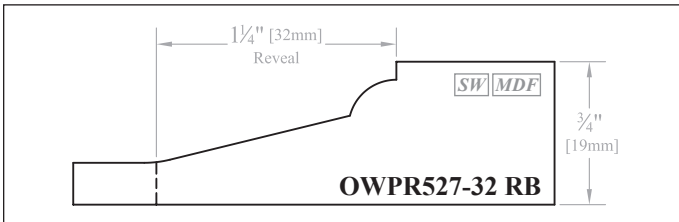
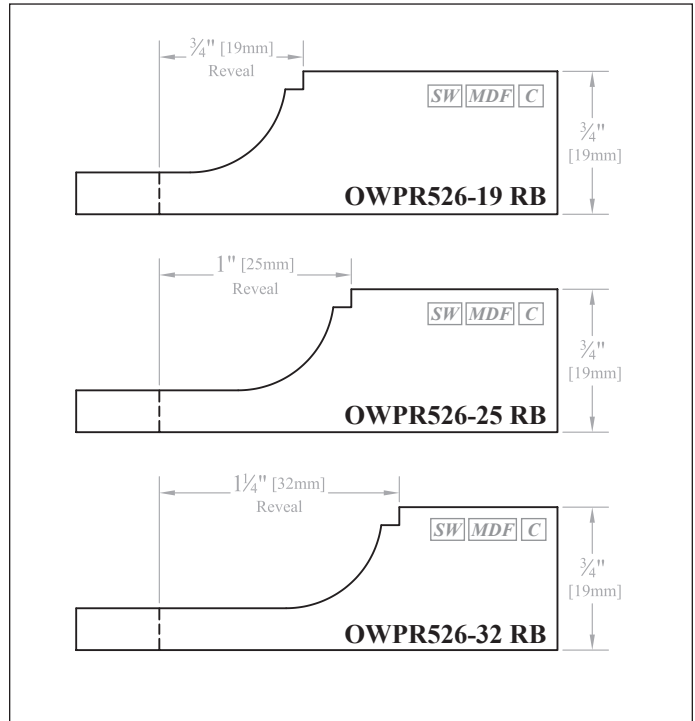
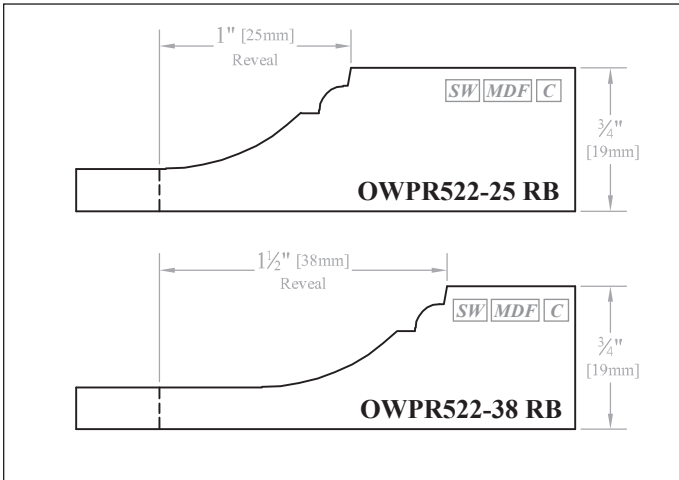

Ordering & Pricing Notes: Center Panel Profiles - Old World

Ordering Guidelines

1	Order Forms	Applicable order forms will include spaces to indicate your chosen profiles.
Pricing		
1	Pricing	Please see <i>Section E.14</i> of our current Wholesale Pricing Catalog.

Technical Notes: Center Panel Profiles - Old World

Convex/Concave Options (Chapter D)

1	Curved Products	The indicates profiles that are available for Convex/Concave products. For additional ordering guidelines, see <i>Chapter D</i> .
---	-----------------	--

General Information (Chapter A)

1	Old World Center Panels	When ordering Old World style doors or drawer fronts, the center panel will be 3/4" [19mm] thick, but recessed on the back side. See <i>Section A.4</i> for an illustration. Old World center panels grow to the face. Some profiles do not look as good as others with this type of construction. The Old World center panel profiles found in this section are for use when ordering Old World style doors and drawer fronts.
---	-------------------------	--

Material Options

1	Material Options	= Profile is available on products made from solid wood. = Profile is available on products made from MDF (Medium Density Fiberboard).
---	------------------	---

Profile Options (Chapter E)

1	Reversed Center Panels (RVSCP)	Please see <i>Section E.13</i> for Reverse Solid Center Panel (RVSCP) options for Old World stile & rail profiles.
---	--------------------------------	--

Center Panel - Old World - END

= Available in Solid Wood = Available for Convex/Concave Products = Available in Medium Density Fiberboard (MDF) OW = Old World RB = Recessed Back

► For PRICING ► See *Section E.14* in our current Wholesale Pricing Catalog.

Profile Options

Outside Edge - Standard

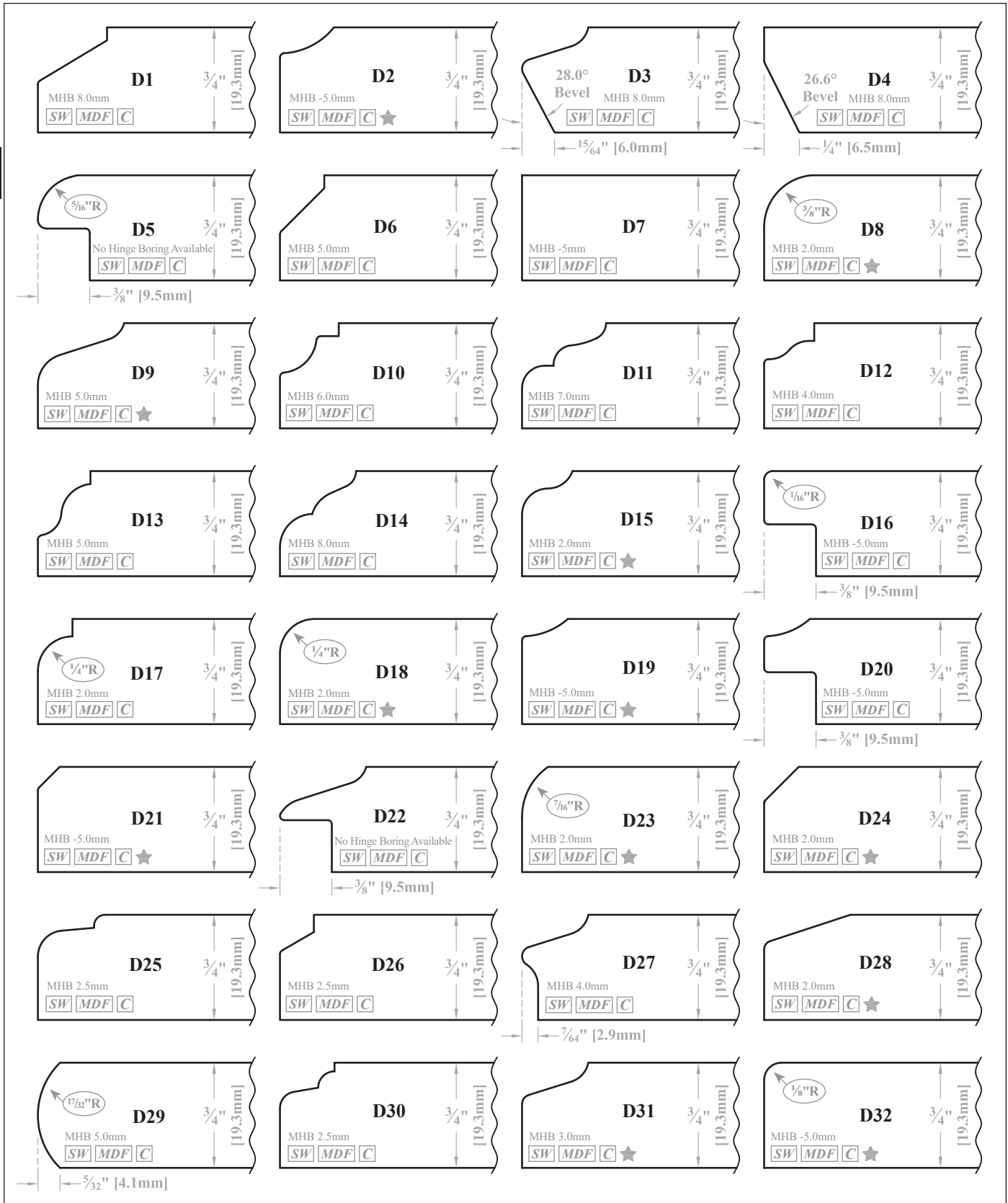

SW = Available in Solid Wood. MDF = Available in Medium Density Fiberboard (MDF). C = Available for Convex/Concave products. ★ = Available on products using 3D Laminate.

► For PRICING ► See Section E.15 in our current Wholesale Pricing Catalog.

Outside Edge - Standard

Profile Options

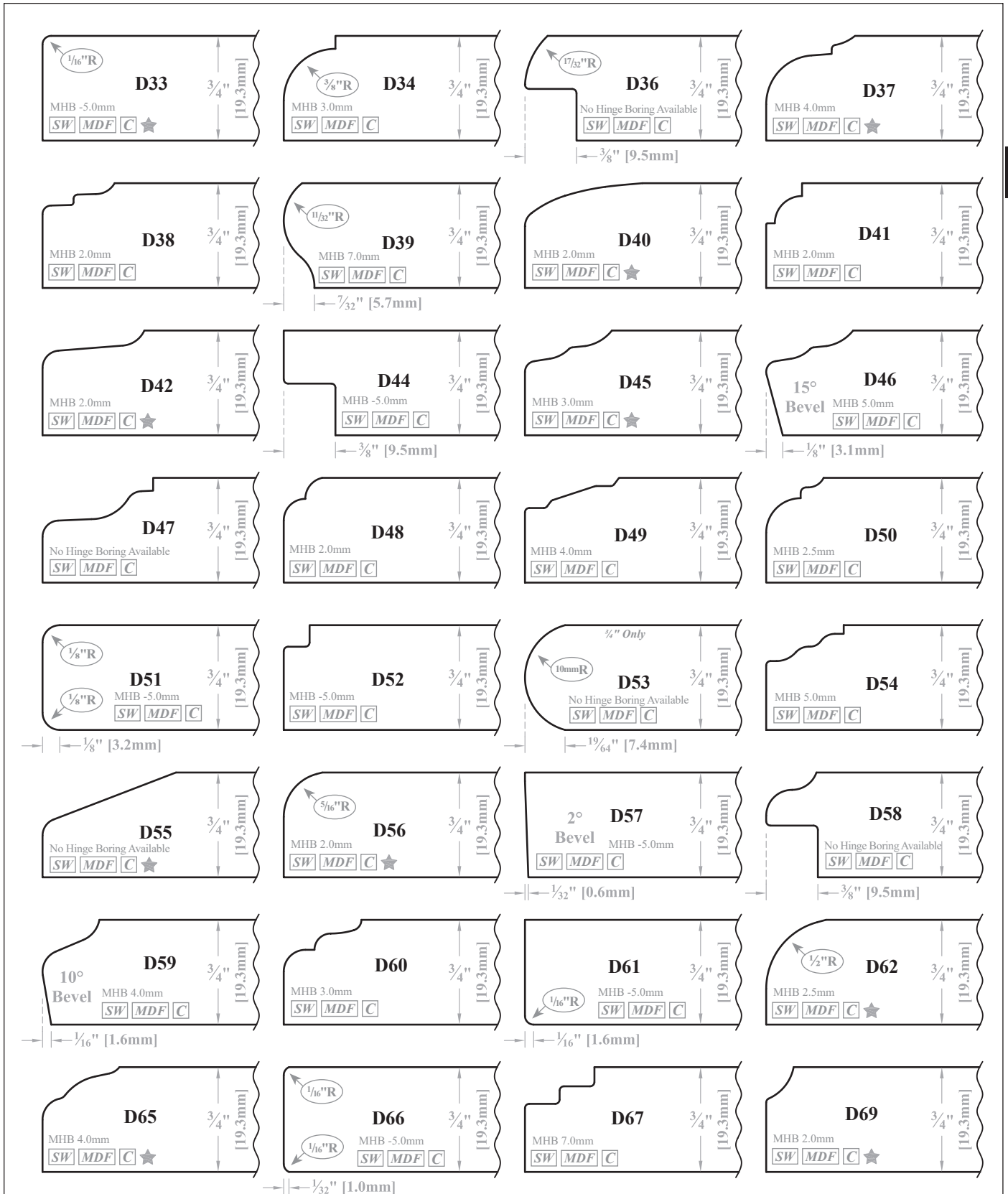

SW = Available in Solid Wood. MDF = Available in Medium Density Fiberboard (MDF). C = Available for Convex/Concave products. MHB = Minimum Hinge Bore setback calculated at 12.7mm deep.

► For PRICING ► See Section E.15 in our current Wholesale Pricing Catalog.

Profile Options

Outside Edge - Standard

E

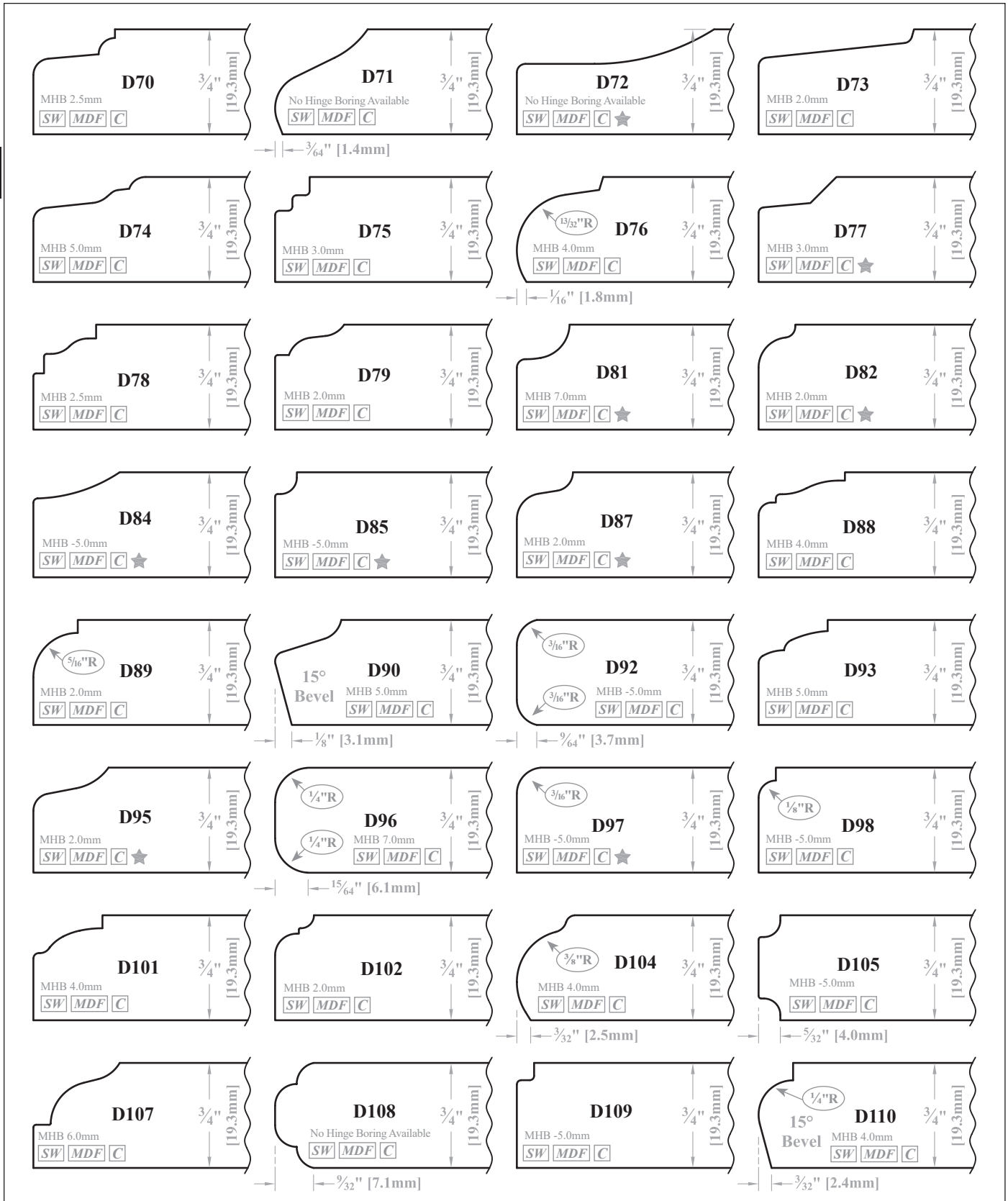

SW = Available in Solid Wood. MDF = Available in Medium Density Fiberboard (MDF). C = Available for Convex/Concave products. ★ = Available on products using 3D Laminate.

► For PRICING ► See Section E.15 in our current Wholesale Pricing Catalog.

Outside Edge - Standard

Profile Options

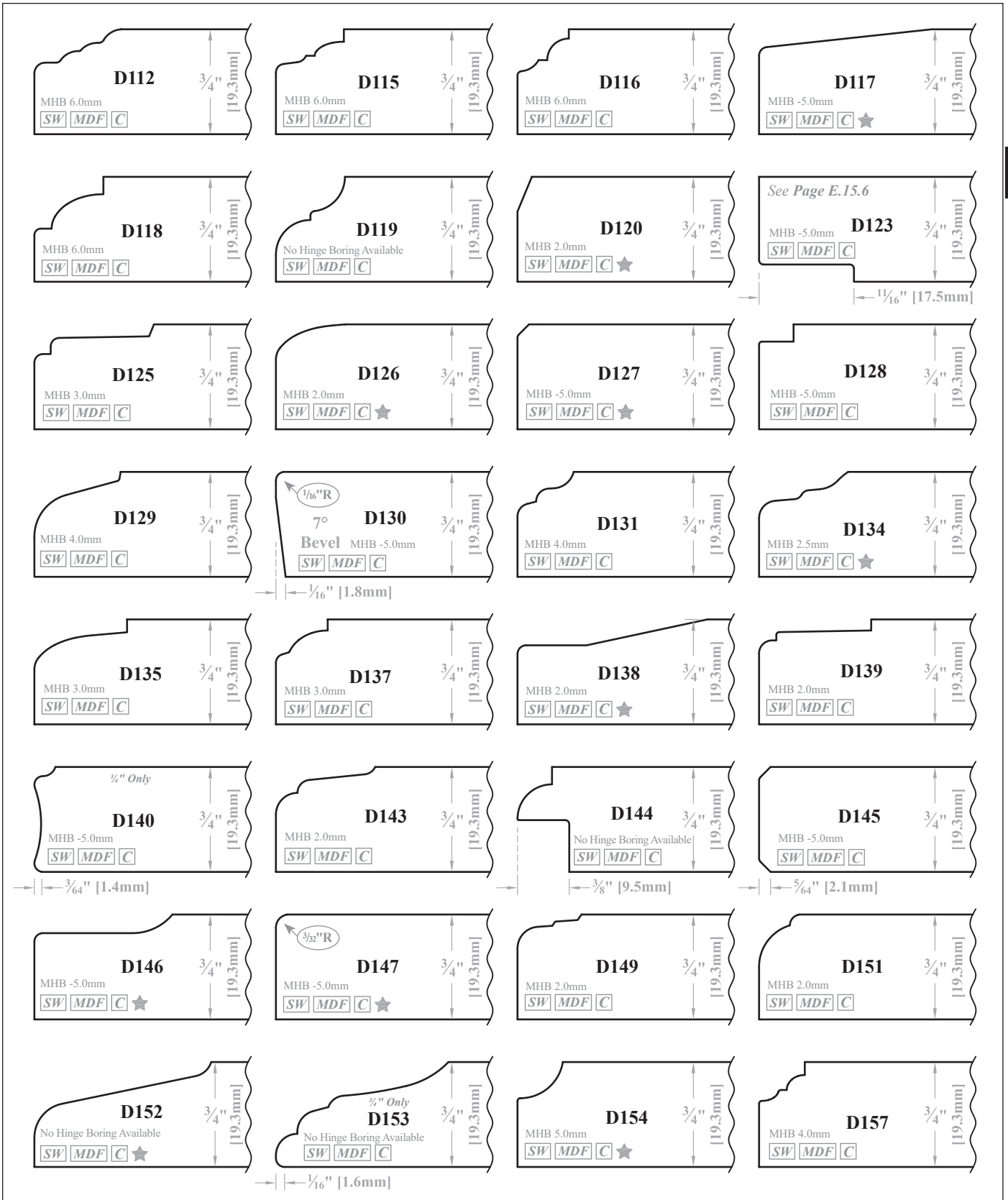

[SW] = Available in Solid Wood. [MDF] = Available in Medium Density Fiberboard (MDF). [C] = Available for Convex/Concave products. MHB = Minimum Hinge Bore setback calculated at 12.7mm deep.

► For PRICING ► See Section E.15 in our current Wholesale Pricing Catalog.

Profile Options

Outside Edge - Standard

E



1" [25.4mm] Thick Outside Edges

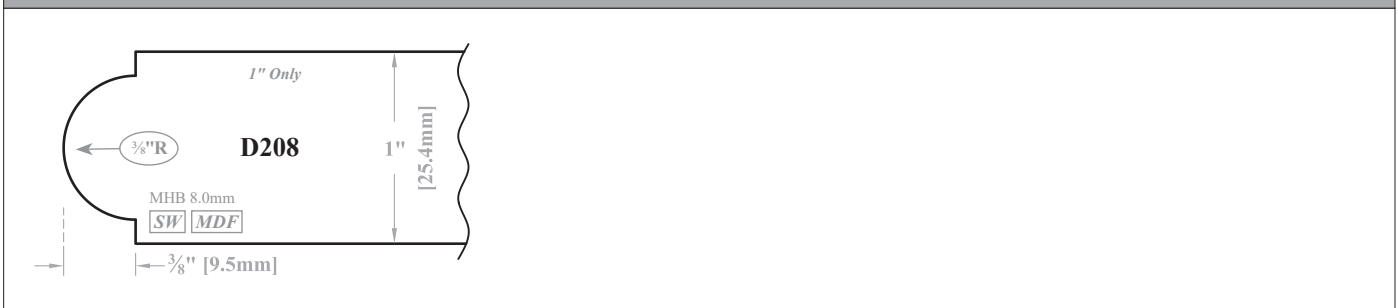

[SW] = Available in Solid Wood. [MDF] = Available in Medium Density Fiberboard (MDF). [C] = Available for Convex/Concave products. ★ = Available on products using 3D Laminate.

► For PRICING ► See Section E.15 in our current Wholesale Pricing Catalog.



Outside Edge - Standard

Profile Options

Ordering & Pricing Notes: Outside Edge Profiles - Standard

Ordering Guidelines

1	Order Forms	Applicable order forms will include spaces to indicate your chosen profiles.
Pricing		
1	Pricing	Please see <i>Section E.15</i> of our current Wholesale Pricing Catalog .

Technical Notes: Outside Edge Profiles - Standard

Convex / Concave Options (Chapter D)

1	Curved Products	The C indicates profiles that are available for Convex/Concave Products. For additional ordering guidelines, see <i>Chapter D</i> .
---	-----------------	---

Finish Options (Chapter R)

1	3D Laminate (RTF)	The ★ indicates profiles that are available on products using 3D Laminate (RTF).
---	-------------------	--

Functional Options (Chapter F)

1	Hinge Boring & Finger Pulls	Please check the compatibility of these options with the outside edge profiles of your choice. Compatibility charts can be found on our website under Resources/Technical Information .
---	-----------------------------	--

Material Options

1	Material Options	SW = Profile is available on products made from solid wood. MDF = Profile is available on products made from MDF (Medium Density Fiberboard).
---	------------------	--

Profile Options (Chapter E)

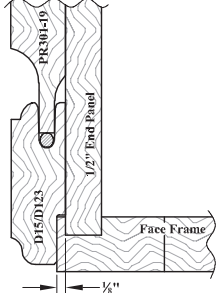
1	D123 Outside Edge Profile	<p>Designed for use as an outside edge profile option on a <u>door that is being used as an end panel</u>.</p> <p>Rabbet size on the D123 is 1/16" [17.5mm] W x 1/8" [3.2mm] H.</p> 
2	D7 Over 1" [25.4mm] Thick	D7 is the <i>only</i> outside edge profile option available for products <i>over</i> 1" [25.4mm] thick.
3	D44 Combination Edges	Several outside edge profiles are available in combination with the D44 outside edge profile. When combining profiles, there will be an additional upcharge. Please check our website under Resources/Technical Information for outside edge profiles compatible with the D44 .

Sizes/Dimensions

1	Size Recommendation	<p>When using D5, D16, D20, D22, D36, D44, D58 and D144 outside edges with inset "lipped door" hinges, we suggest ordering doors 1/2" [12.7mm] wider and 1/2" [12.7mm] higher than the face frame opening.</p> <p>When using the D123 outside edge profile, doors should be ordered 1 1/8" [28.6mm] wider and higher than the face frame opening.</p> <p>When using D180 outside edge with inset "lipped door" hinges, we suggest ordering doors 5/8" [15.9mm] wider and 5/8" [15.9mm] higher than the face frame opening.</p>
---	---------------------	--

Standard Outside Edge Profiles - END

SW = Available in Solid Wood. MDF = Available in Medium Density Fiberboard (MDF). C = Available for Convex/Concave products. MHB = Minimum Hinge Bore setback calculated at 12.7mm deep.

► For PRICING ► See *Section E.15* in our current Wholesale Pricing Catalog.

Profile Options

Outside Edge - Applied Molding

Applied Molding Outside Edges for 3/16" Thick Raw MDF or Solid Wood Slabs

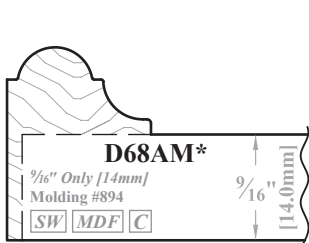

PC: AM103 Multiplier: .72
No Hinge Boring Available

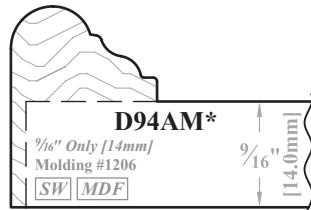

PC: AM103 Multiplier: .72
No Hinge Boring Available

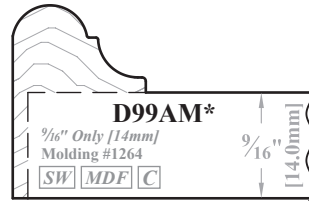

PC: AM103 Multiplier: .72
No Hinge Boring Available

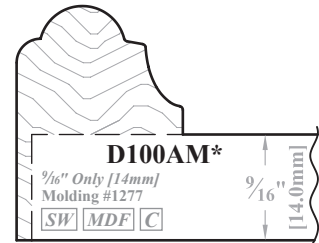

PC: AM103 Multiplier: .72
No Hinge Boring Available

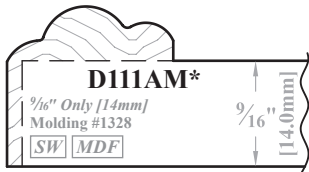

PC: AM103 Multiplier: .72
No Hinge Boring Available

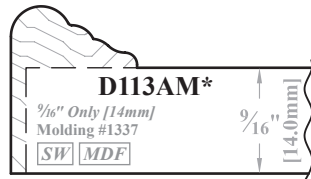

PC: AM103 Multiplier: .72
No Hinge Boring Available

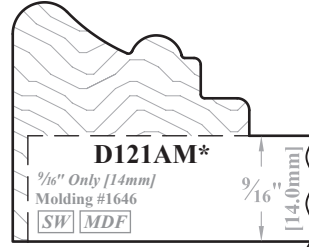

PC: AM103 Multiplier: .82
No Hinge Boring Available

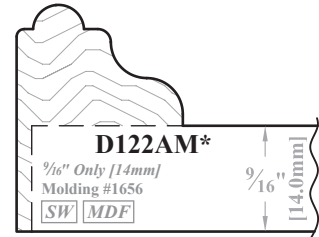

PC: AM103 Multiplier: .72
No Hinge Boring Available



PC: AM103 Multiplier: .72
No Hinge Boring Available

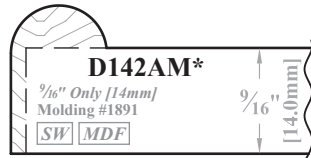

PC: AM101 Multiplier: .72
No Hinge Boring Available

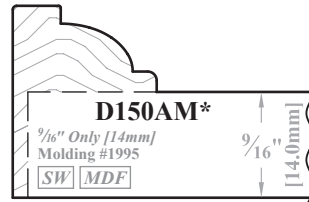

PC: AM103 Multiplier: .72
No Hinge Boring Available



PC: AM101 Multiplier: .72
No Hinge Boring Available

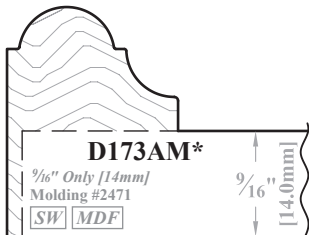

PC: AM103 Multiplier: .80
No Hinge Boring Available

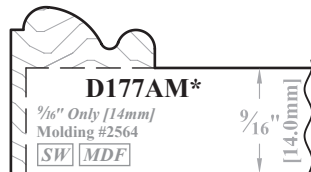

PC: AM101 Multiplier: .72
No Hinge Boring Available



PC: AM101 Multiplier: .72
No Hinge Boring Available



PC: AM101 Multiplier: .72
No Hinge Boring Available

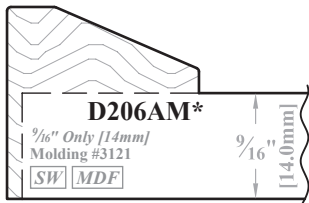

PC: AM103 Multiplier: .72
No Hinge Boring Available

Applied Molding Outside Edges for 5/8" Thick Raw MDF or Solid Wood Slabs

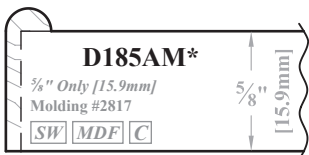

PC: AM102 Multiplier: .72
No Hinge Boring Available

[SW] = Available in Solid Wood. [MDF] = Available in Medium Density Fiberboard (MDF). [C] = Available for Convex/Concave products. * = MDF Core recommended due to expansion & contraction.



Applied Molding Outside Edges for 3/4" Thick Raw MDF or Solid Wood Slabs

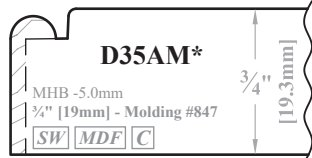

D35AM*
MHB -5.0mm
3/4" [19mm] - Molding #847
[SW] [MDF] [C]

PC: AM101 Multiplier: .72

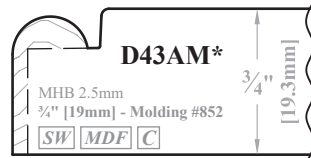

D43AM*
MHB 2.5mm
3/4" [19mm] - Molding #852
[SW] [MDF] [C]

PC: AM101 Multiplier: .72

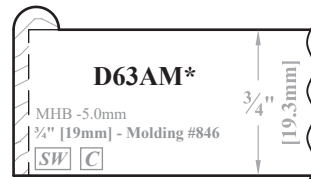

D63AM*
MHB -5.0mm
3/4" [19mm] - Molding #846
[SW] [C]

PC: AM103 Multiplier: .72

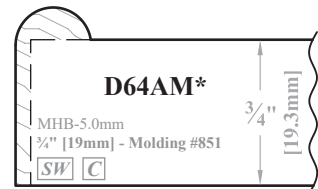

D64AM*
MHB -5.0mm
3/4" [19mm] - Molding #851
[SW] [C]

PC: AM103 Multiplier: .72

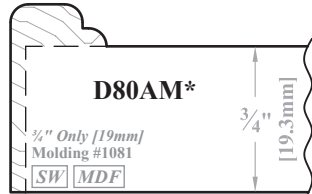

D80AM*
3/4" Only [19mm]
Molding #1081
[SW] [MDF]

PC: AM103 Multiplier: .72
MHB -5.0mm

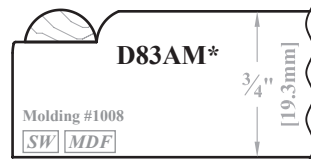

D83AM*
Molding #1008
[SW] [MDF]

See Outsourced Moldings Section N.13.
MHB 2.0mm

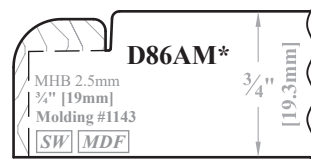

D86AM*
MHB 2.5mm
3/4" [19mm]
Molding #1143
[SW] [MDF]

PC: AM101 Multiplier: .72

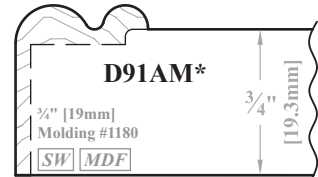

D91AM*
3/4" [19mm]
Molding #1180
[SW] [MDF]

PC: AM103 Multiplier: .72
MHB -5.0mm

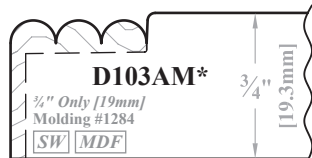

D103AM*
3/4" Only [19mm]
Molding #1284
[SW] [MDF]

PC: AM101 Multiplier: .72
MHB 2.5mm

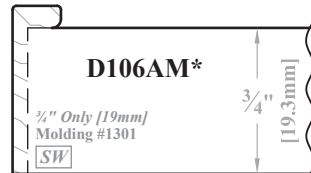

D106AM*
3/4" Only [19mm]
Molding #1301
[SW]

PC: AM103 Multiplier: .72
MHB -5.0mm

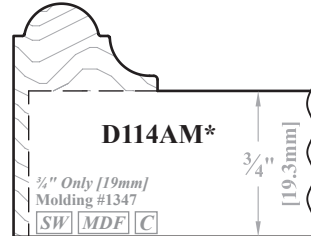

D114AM*
3/4" Only [19mm]
Molding #1347
[SW] [MDF] [C]

PC: AM103 Multiplier: .72
MHB -5.0mm

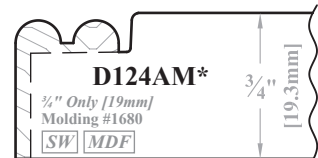

D124AM*
3/4" Only [19mm]
Molding #1680
[SW] [MDF]

PC: AM101 Multiplier: .72
MHB 2.5mm

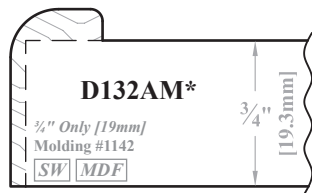

D132AM*
3/4" Only [19mm]
Molding #1142
[SW] [MDF]

PC: AM103 Multiplier: .72
MHB -5.0mm

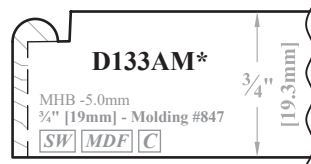

D133AM*
MHB -5.0mm
3/4" [19mm] - Molding #847
[SW] [MDF] [C]

PC: AM101 Multiplier: .72



D148AM*
Molding #1008
[SW] [MDF]

See Outsourced Moldings Section N.13.
MHB -5.0mm

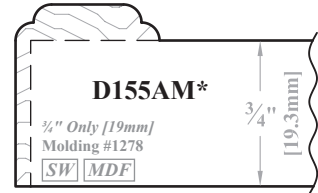

D155AM*
3/4" Only [19mm]
Molding #1278
[SW] [MDF]

PC: AM103 Multiplier: .72
MHB -5.0mm

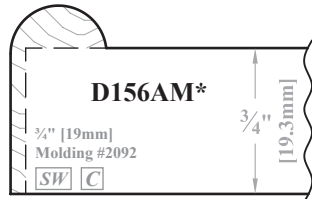

D156AM*
3/4" [19mm]
Molding #2092
[SW] [C]

PC: AM103 Multiplier: .72
MHB -5.0mm

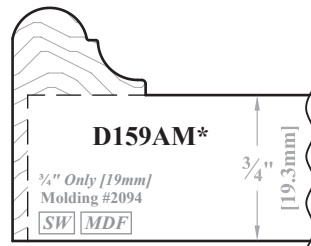

D159AM*
3/4" Only [19mm]
Molding #2094
[SW] [MDF]

PC: AM103 Multiplier: .82
MHB -5.0mm

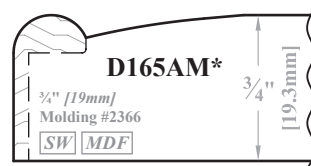

D165AM*
3/4" [19mm]
Molding #2366
[SW] [MDF]

PC: AM101 Multiplier: .72
MHB -5.0mm



D178AM*
3/4" Only [19mm]
Molding #2593
[SW] [MDF]

PC: AM101 Multiplier: .72
MHB -5.0mm

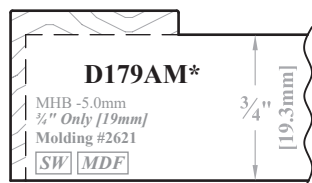

D179AM*
MHB -5.0mm
3/4" Only [19mm]
Molding #2621
[SW] [MDF]

PC: AM103 Multiplier: .72

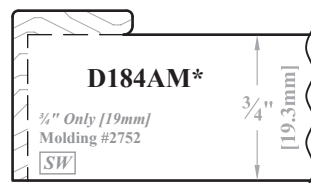

D184AM*
3/4" Only [19mm]
Molding #2752
[SW]

PC: AM103 Multiplier: .72
MHB -5.0mm

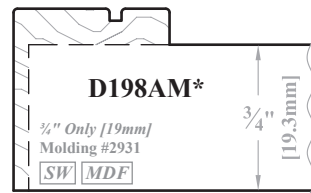

D198AM*
3/4" Only [19mm]
Molding #2931
[SW] [MDF]

PC: AM103 Multiplier: .72
MHB -5.0mm

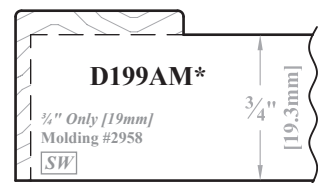

D199AM*
3/4" Only [19mm]
Molding #2958
[SW]

PC: AM103 Multiplier: .72
MHB -5.0mm

[SW] = Available in Solid Wood. [MDF] = Available in Medium Density Fiberboard (MDF). [C] = Available for Convex/Concave products. * = MDF Core recommended due to expansion & contraction.

► For PRICING ► See Section E.16 in our current Wholesale Pricing Catalog.

Profile Options

Outside Edge - Applied Molding

Applied Molding Outside Edges for 3/4" Thick Raw MDF or Solid Wood Slabs...continued

<p>D201AM* 3/4" Only [19mm] Molding #3043 [SW] [MDF]</p> <p>PC: AM103 Multiplier: .72 MHB -5.0mm</p>	<p>D202AM* 3/4" Only [19mm] Molding #3047 [SW] [MDF]</p> <p>PC: AM103 Multiplier: .85 MHB -5.0mm</p>	<p>D204AM* 3/4" Only [19mm] Molding #847 [SW] [MDF]</p> <p>PC: AM101 Multiplier: .72 MHB -5.0mm</p>	<p>D207AM* 3/4" Only [19mm] Molding #3124 [SW] [MDF]</p> <p>PC: AM103 Multiplier: .72 MHB -5.0mm</p>
<p>D209AM* 3/4" Only [19mm] Molding #3141 [SW] [MDF]</p> <p>PC: AM103 Multiplier: .72 MHB -5.0mm</p>	<p>D211AM* 3/4" Only [19mm] Molding #3151 [SW] [MDF]</p> <p>PC: AM103 Multiplier: .72 MHB -5.0mm</p>	<p>D212AM* 3/4" Only [19mm] Molding #3158 [SW] [MDF]</p> <p>PC: AM103 Multiplier: .72 MHB -5.0mm</p>	<p>D215AM* 3/4" Only [19mm] Molding #3194 [SW] [MDF]</p> <p>PC: AM103 Multiplier: .72 MHB -5.0mm</p>

Applied Molding Outside Edges for 1" Thick Raw MDF or Solid Wood Slabs

<p>D186AM* MHB -5.0mm 1" Only [25.4mm] Molding #846 [SW] [MDF]</p> <p>PC: AM103 Multiplier: .72</p>	<p>D187AM* MHB -5.0mm 1" Only [25.4mm] Molding #851 [SW] [MDF]</p> <p>PC: AM103 Multiplier: .72</p>	<p>D188AM* MHB -5.0mm 1" Only [25.4mm] Molding #1354 [SW] [MDF]</p> <p>PC: AM103 Multiplier: .76</p>	<p>D189AM* MHB -5.0mm 1" Only [25.4mm] Molding #1993 [SW] [MDF]</p> <p>PC: AM103 Multiplier: .78</p>
<p>D190AM* MHB -5.0mm 1" Only [25.4mm] Molding #1142 [SW] [MDF]</p> <p>PC: AM103 Multiplier: .72</p>	<p>D191AM* MHB -5.0mm 1" Only [25.4mm] Molding #1184 [SW] [MDF]</p> <p>PC: AM103 Multiplier: .75</p>	<p>D192AM* MHB -5.0mm 1" Only [25.4mm] Molding #846 [SW] [MDF]</p> <p>PC: AM103 Multiplier: .72</p>	<p>D193AM* MHB -5.0mm 1" Only [25.4mm] Molding #2093 [SW] [MDF]</p> <p>PC: AM103 Multiplier: .82</p>
<p>D194AM* MHB -5.0mm 1" Only [25.4mm] Molding #2367 [SW] [MDF]</p> <p>PC: AM101 Multiplier: .72</p>	<p>D195AM* MHB -5.0mm 1" Only [25.4mm] Molding #2592 [SW] [MDF]</p> <p>PC: AM103 Multiplier: .72</p>	<p>D196AM* MHB -5.0mm 1" Only [25.4mm] Molding #2622 [SW] [MDF]</p> <p>PC: AM103 Multiplier: .72</p>	

[SW] = Available in Solid Wood. [MDF] = Available in Medium Density Fiberboard (MDF). [C] = Available for Convex/Concave products. * = MDF Core recommended due to expansion & contraction.

► For PRICING ► See Section E.16 in our current Wholesale Pricing Catalog.



Ordering & Pricing Notes: Outside Edge Profiles - Applied Molding

Ordering Guidelines

1	Order Forms	Applicable order forms will include spaces to indicate your chosen profiles.
Pricing		
1	Pricing	Please see <i>Section E.16</i> of our current Wholesale Pricing Catalog.

Technical Notes: Outside Edge Profiles - Applied Molding

Cabinet Door & Drawer Front Options (Chapter B, V)

1	Solid Wood Slab Drawer Front Styles	<ul style="list-style-type: none"> Drawer fronts with 1/16" [14mm] outside edge applied molding profiles are ordered as Style 916SQA. <ul style="list-style-type: none"> Style 916SQA is only available when using one of the 1/16" [14mm] outside edge applied molding profiles. Drawer fronts with 3/8" [15.9mm] outside edge applied molding profiles are ordered as Style 58SQA. <ul style="list-style-type: none"> Style 58SQA is only available when using one of the 3/8" [15.9mm] outside edge applied molding profiles. Drawer fronts with 3/4" [19.3mm] outside edge applied molding profiles are ordered as Style 34SQA. Drawer fronts with 1" [25.4mm] outside edge applied molding profiles are ordered as Style 100SQE. See <i>Section B.16</i>.
2	Veneered Slab Door and Drawer Front Styles	<p>If wanting a wood veneer door or drawer front with an MDF core, please order as a Style 60 door or Style 60* drawer front with EBT100 or EBT101 (see <i>Section B.10</i>).</p> <ul style="list-style-type: none"> EBT100 is only available when using one of the 1/16" [14mm] outside edge applied molding profiles. EBT101 can be used for 3/4" [19.1mm] outside edge applied molding profiles. See EBT101 notes in <i>Section B.10</i> for profile availability.
3	1-Piece Raw MDF Door and Drawer Front Styles	<p>The following 1-Piece raw MDF door and drawer front styles are available with applied molding outside edge profiles in 3/4" and 1" thicknesses: 500/500*, 515, 516, 517, 518/518*, 518-Frame, 519, 520, 521, 523, 524L, 524R, 526L, 526R, 528, 529, 530, 531, 570/570*, 580/580*.</p> <ul style="list-style-type: none"> Style 500/500* are also available 1/16" or 3/8" thick when using one of the applied molding outside edge profiles for 1/16" or 3/8" thick raw MDF.

Convex/Concave Options (Chapter D)

1	Curved Products	The <input type="checkbox"/> indicates profiles that are available for Convex/Concave Products. For additional ordering guidelines, see <i>Chapter D</i> .
---	-----------------	--

Functional Options (Chapter F)

1	Hinge Boring & Finger Pulls	Please check the compatibility of these options with the outside edge profiles of your choice. Compatibility charts can be found on our website under Resources/Technical Information .
---	-----------------------------	--

General Information (Chapter A)

1	Warranty	Please see <i>Section A.8 - Warranties</i> for more information on Glued Up Panel expansion/contraction, warping, bowing and twisting.
2	Ready to Assemble (RTA)	Doors and drawer fronts with applied molding are not available Ready to Assemble (RTA).

Material Options

1	MDF Core Recommended for Slab Doors & DFs (*)	<p>When ordering a slab style door or drawer front with an outside edge applied molding profile, WalzCraft recommends using an MDF core material to avoid issues that may occur due to expansion and contraction.</p> <ul style="list-style-type: none"> The applied molding itself will be made from either Maple-Hard/Soft Mixed-Value/Budget/Paint Grade, Birch Value/Budget/Paint Grade or Poplar-Value/Budget/Paint Grade.
2	Material Options	<p><input type="checkbox"/> = Profile is available on products made from solid wood.</p> <p><input type="checkbox"/> = Profile is available on products made from MDF (Medium Density Fiberboard).</p>

Profile Options (Chapter E)

1	D148	<p>Accepts the #1008 rope molding.</p> <ul style="list-style-type: none"> Corner block molding #1217 or #1735 can also be added. Not available with convex/concave products when using these applied moldings.
2	D83	<p>Accepts the #1008 rope molding.</p> <ul style="list-style-type: none"> Corner block molding #1735 can also be added. Not available with convex/concave products when using these applied moldings.
3	D7/1" [25.4mm] Thickness	D7 is the only outside edge profile option available for products over 1" [25.4mm] thick (see <i>Section E.15</i>).

Continued on next page...

► For PRICING ► See Section [E.16](#) in our current Wholesale Pricing Catalog.

Profile Options

Outside Edge - Applied Molding

Outside Edge Applied Molding Profiles / Core Thickness Availability

Outside Edge Applied Molding Profile	3/16" [14mm] Thick Material Door/DF Styles			5/8" [15.9mm] Thick Material Door/DF Styles			3/4" [19.3mm] Thick Material Door/DF Styles			1" [25.4mm] Thick Material Door/DF Styles		
	Raw MDF 500/500*	Veneer (MDF Core) 60/60* w/ EBT100	Solid Wood 916SQA*	Raw MDF 500/500*	Veneer (MDF Core) 60/60* w/ EBT100	Solid Wood 58SQA*	Raw MDF *See Notes	Veneer (MDF Core) 60/60* w/ EBT101	Solid Wood 34SQA*	Raw MDF *See Notes	Veneer (MDF Core) 60/60* w/ EBT101	Solid Wood 100SQE*
D35AM*							X		X			
D43AM*							X		X			
D63AM*							(NP408) ¹	(NP408) ¹	X			
D64AM*							(NP409) ¹	(NP409) ¹	X			
D68AM*	X	X	X									
D80AM*							X	X	X			
D83AM*							X		X	X	X	
D86AM*							X		X			
D91AM*							X	X	X			
D94AM*	X	X	X									
D99AM*	X	X	X									
D100AM*	X	X	X									
D103AM*							X		X			
D106AM*							(NP401) ¹	(NP401) ¹	X			
D111AM*	X	X	X									
D113AM*	X	X	X									
D114AM*							X	X	X			
D121AM*	X	X	X									
D122AM*	X	X	X									
D124AM*							X		X			
D132AM*							X	X	X			
D133AM*							X		X			
D136AM*	X	X	X									
D142AM*	X	X	X									
D148AM*							X		X	X	X	
D150AM*	X	X	X									
D155AM*							X	X	X			
D156AM*							(NP410) ¹	(NP410) ¹	X			
D159AM*							X	X	X			
D165AM*							X		X			
D171AM*	X	X	X									
D173AM*	X	X	X									
D177AM*	X	X	X									
D178AM*							X		X			
D179AM*							X	X	X			
D183AM*	(NP407) ¹	(NP407) ¹	X									
D184AM*							(NP403) ¹	(NP403) ¹	X			
D185AM*				X		X						
D186AM*										X	X	
D187AM*										X	X	
D188AM*										X	X	
D189AM*										X	X	
D190AM*										X	X	
D192AM*										X	X	
D193AM*										X	X	
D194AM*										X	X	

► For PRICING ► See Section E.16 in our current Wholesale Pricing Catalog.

Outside Edge - Applied Molding

Profile Options

Outside Edge Applied Molding Profiles / Core Thickness Availability

Outside Edge Applied Molding Profile	3/16" [14mm] Thick Material Door/DF Styles			5/8" [15.9mm] Thick Material Door/DF Styles			3/4" [19.3mm] Thick Material Door/DF Styles			1" [25.4mm] Thick Material Door/DF Styles		
	Raw MDF 500/500*	Veneer (MDF Core) 60/60* w/ EBT100	Solid Wood 916SQA*	Raw MDF 500/500*	Veneer (MDF Core) 60/60* w/ EBT100	Solid Wood 58SQA*	Raw MDF *See Notes	Veneer (MDF Core) 60/60* w/ EBT101	Solid Wood 34SQA*	Raw MDF *See Notes	Veneer (MDF Core) 60/60* w/ EBT101	Solid Wood 100SQE*
D195AM*										X		X
D196AM*										X	X	X
D197AM*	X	X	X									
D198AM*							X	X	X			
D199AM*							(NP404) ¹	(NP404) ¹	X			
D201AM*							(NP405) ¹	(NP405) ¹	X			
D202AM*							X	X	X			
D204AM*							X		X			
D206AM*	X	X	X									
D207AM*							(NP402) ¹	(NP402) ¹	X			
D209AM*							X	X	X			
D211AM*							X	X	X			
D212AM*							X	X	X			
D215AM*							X	X	X			

¹ = Order as a Nexus door or drawer front (Section B.20) with the Nexus profile indicated.

Outside Edge - Applied Molding - END

► For PRICING ► See Section E.16 in our current Wholesale Pricing Catalog.

