

Distributed by:

*WalzCraft*<sup>®</sup>



*Designs of distinction*<sup>®</sup>  
Kitchen, Bath & Home  
by BWI

Materials and Components for Kitchen, Bath and Home.

## TABLE OF CONTENTS



P.O. Box 1748, La Crosse, WI 54602-1748  
2600 Hemstock St, La Crosse, WI  
54603-2349

phone: 800-237-1326  
fax: 608-781-3667  
[www.WalzCraft.com](http://www.WalzCraft.com)



[www.x.com/WalzCraft](http://www.x.com/WalzCraft)



[www.facebook.com/WalzCraft/](http://www.facebook.com/WalzCraft/)



[www.instagram.com/walzcraft/](http://www.instagram.com/walzcraft/)



[www.pinterest.com/walzcraft/](http://www.pinterest.com/walzcraft/)



**RESPONSIBLE  
STEWARDS OF THE  
ENVIRONMENT**

©BROWN WOOD INC.  
ALL RIGHTS RESERVED 2026  
ALL DESIGNS ARE THE EXCLUSIVE PROPERTY OF  
BROWN WOOD, INC. AND MAY NOT BE USED OR  
REPRODUCED WITHOUT EXPRESS  
WRITTEN PERMISSION

- ii | INTRODUCTION  
MATERIALS AND FINISHES  
SECONDARY SERVICES**
- 1 | MATERIALS  
TAMBOUR | **NEW**  
METAL ACCENTS  
CUT-TO-SIZE MATERIALS | **NEW****
- 19 | POSTS & TABLE LEGS**
- 34 | END PANELS & STEEL BASES | **NEW****
- 41 | BUN FEET**
- 51 | BRACKETS & CORBELS | **NEW****
- 62 | CREATE-A-COLUMN™ AND  
HALF ROUND MOULDING**
- 66 | DECORATIVE MOULDING & PILASTERS**
- 68 | SHELVING**
- 72 | OUTLETS & VENTS**
- 77 | CUSTOM PANEL INSERTS | **NEW****
- 81 | GALLERY RAIL**
- 84 | DECORATIVE BRASS HARDWARE | **NEW****
- 89 | INDEX & WARRANTY**
- 94 | Rigid Panel Warning**
- 95 | Samples and Sample Kits**

## ANODIZED ALUMINUM

We use a special Aluminum alloy to create our decorative aluminum accents. This special alloy can be chemically brightened. Our Aluminum finishes are anodized and feature bright chromes, soft satins and deep matte finishes. Anodizing is considered the best method of finishing in order to achieve a true metallic look. Anodized finishes are extremely durable and will not flake, peel or fade.

**If exact color is critical to your project, please request color samples.**



**CR:** Chrome



**WB:** Warm Bronze

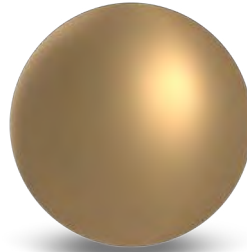

**SB:** Satin Brass



**PB:** Polished Brass



**WR:** Flat Black



**BA:** Brushed Aluminum



**SS:** Satin Stainless



**TM:** Titanium

## SOLID BRASS

Cast brass, made of a copper/zinc alloy, is known for its material integrity, smooth surface finish, durability, and strength.

Cast brass Feet & Slipper Cups will outlast normal wear and will maintain its bright finish for years to come.

**AB:** Antique Brass



**WR:** Flat Black



**PB:** Polished Brass

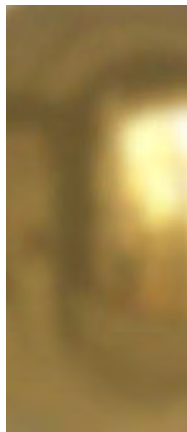

**CR:** Chrome



**SB:** Satin Brass



## WOOD SPECIES

We source only the finest FAS (First and Seconds) hardwoods for our products. The majority of our products are made from laminated blocks with more than one glue line. We strive to provide the best possible color match between staves, but variations may occur. Variations in color and grain pattern are natural characteristics of wood and are not considered defects.



**AL:** Alder

**CH:** Cherry

**MDF:** Medium-Density Fiberboard

**HM:** Hard Maple

**AK:** Red Oak

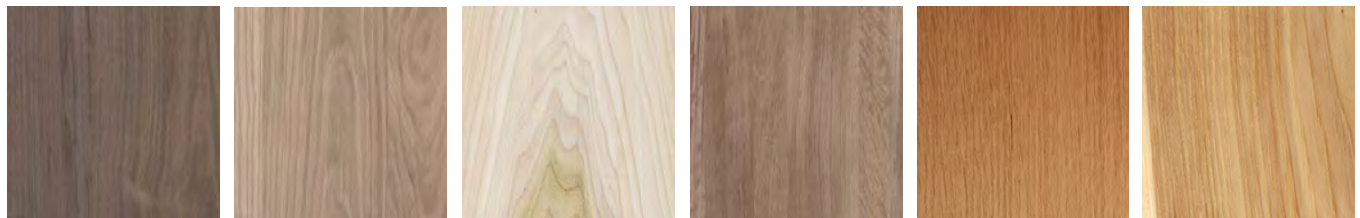

**WL:** Walnut

**WK:** White Oak

**PT:** Paint Grade

**QW:** Quarter Sawn White Oak

**QS:** Quarter Sawn Red Oak

**HK:** Hickory

## ELECTROPLATED WIRE GRILLE FINISHES

Our electroplated Decorative Grilles are hand woven & crimped from superior steel wire. The process of electroplating deposits metal finishes onto the steel through electricity creating both bright and antique finishes. Finishes can vary from run to run. **If exact color is critical to your project, please request samples. Sample Kits available on our website.**

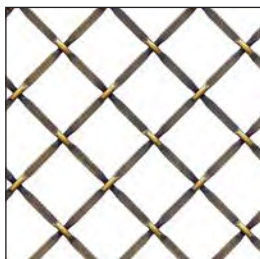

**AB:** Antique Brass

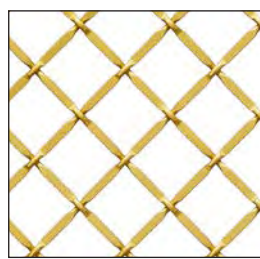

**SB:** Satin Brass

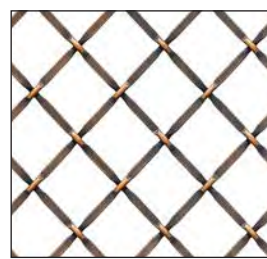

**AC:** Antique Copper



**AP:** Antique Pewter



**SN:** Polished Satin Nickel

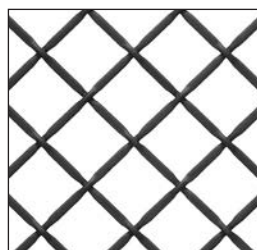

**WR:** Flat Black

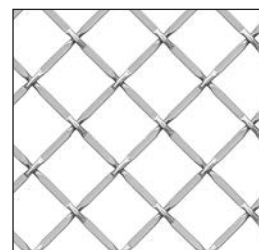

**SS:** Stainless Steel Look

## SPECIAL WOOD CUTS & SECONDARY SERVICES

We are pleased to offer several options to help you in your design process. Secondary services such as splitting in half, quarter notching, electrical outlet notching, and hanger bolt installation are available on the majority of our columns, legs and bun feet. Additional charges apply.

### QUARTER CUT



#### 01QUARTERNOTCH

Quarter notching creates a single quartered piece and a single 3/4 piece. Both pieces are included in purchase.

### SPLIT



#### 01SPLITCOLUMN

Split column in half. 1/8" of thickness may be lost due to saw kerf. Both halves are included in purchase.

### ANGLE CUT



#### 01ANGLECUT

Product is cut at an angle from corner to corner, full length only. Both pieces are included in purchase.

### STOP NOTCH



#### 01STOPNOTCH

Stop notch a column. Let us know how far down you would like notched.

### SPLIT BUN FOOT



#### 01SPLITFEET

Split bun foot in half. Both pieces are included in purchase.

### HANGER BOLT



#### 01HANGERBOLT

5/16-18 hanger bolt installed in one end. Hanger bolt installed to protrude 1/2".

### BOX ROUTE



#### 01BXROUTE

Add an electrical box to your column.

### ELECTRICAL BORE



#### 01ELECBORE

A 1/2" hole the entire length of the column.

### MOULDING & TAMBOUR TRIM

We will cut your 96" moulding to 92" to reduce shipping costs.



\*Please note - not all items can be cut in all the formats above, nor can all columns receive an Electrical Box Notch.  
**All custom cut products are non-returnable.**

This page intentionally left blank.



**MATERIALS: FLEXIBLE TAMBOUR  
& RIGID BEADED PANELS**

# FLEXIBLE TAMBOUR PANELS

Made in the USA. Our thin material backer allows Flexible Panels to be used as a wrap as well as flat applications. Flexible beaded panels consist of individual staves, glued to a flexible canvas or paper backer. Suitable for residential and commercial applications. Unfinished American Hardwoods can be easily stained or painted in colors and finishes of your choice.

For **onlay** applications - such as walls, hoods, or cabinet wraps. 48" and 96" lengths in stock. Custom sizes available.

**Stock finishes in: Red Oak (AK), Hard Maple (HM), Paint Grade Poplar (PT), Walnut (WL) & White Oak (WK).**  
To order, refer to the style numbers listed below.



STYLE 100	STYLE 101	STYLE 102
<p><b>011248100-1</b> 12"W x 48"L x .25"T  <b>011296100-1</b> 12"W x 96"L x .25"T  <b>012448100-1</b> 24"W x 48"L x .25"T</p>	<p><b>011248101-1</b> 12"W x 48"L x .313"T  <b>011296101-1</b> 12"W x 96"L x .313"T</p>	<p><b>011248102-1</b> 12"W x 48"L x .375"T  <b>011296102-1</b> 12"W x 96"L x .375"T  <b>012448102-1</b> 24"W x 48"L x .375"T</p>
STYLE 103	STYLE 104	STYLE 105
<p><b>011248103-1</b> 12"W x 48"L x .313"T  <b>011296103-1</b> 12"W x 96"L x .313"T</p>	<p><b>011248104-1</b> 12"W x 48"L x .5"T  <b>011296104-1</b> 12"W x 96"L x .5"T</p>	<p><b>011248105-1</b> 12"W x 48"L x .375"T  <b>011296105-1</b> 12"W x 96"L x .375"T</p>
STYLE 106	STYLE 107	STYLE 110
<p><b>011248106-1</b> 12"W x 48"L x .75"T  <b>011296106-1</b> 12"W x 96"L x .75"T</p>	<p><b>011248107-1</b> 12"W x 48"L x .375"T  <b>011296107-1</b> 12"W x 96"L x .375"T  <b>012448107-1</b> 24"W x 48"L x .375"T  <b>012434107-1</b> 24"W x 34"L x .375"T</p>	<p><b>011248110-1</b> 12"W x 48"L x .25"T  <b>011296110-1</b> 12"W x 96"L x .25"T  <b>012448110-1</b> 24"W x 48"L x .25"T</p>

## MATERIALS

<b>AK:</b> Red Oak	<b>HM:</b> Hard Maple	<b>MDF:</b> Medium Density Fiberboard	<b>PT:</b> Paint Grade	<b>WL:</b> Walnut	<b>WK:</b> White Oak
-----------------------	--------------------------	---	---------------------------	----------------------	-------------------------

## FLEXIBLE TAMBOUR PANELS

Made in the USA. Our thin material backer allows Flexible Panels to be used as a wrap as well as flat applications. Flexible beaded panels consist of individual staves, glued to a flexible canvas or paper backer. Suitable for residential and commercial applications. Unfinished American Hardwoods can be easily stained or painted in colors and finishes of your choice.

For **onlay** applications - such as walls, hoods, or cabinet wraps. 48" and 96" lengths in stock. Custom sizes available.

**Stock finishes in: Red Oak (AK), Hard Maple (HM), Paint Grade Poplar (PT), Walnut (WL) & White Oak (WK).**  
To order, refer to the style numbers listed below.

### SQUARE

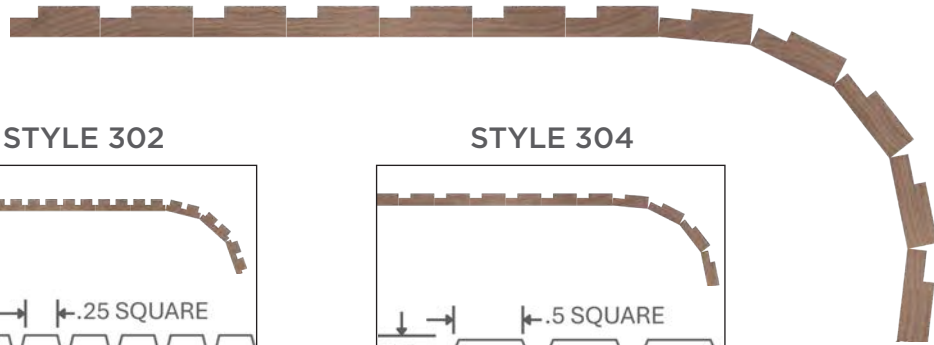

**STYLE 302**

**011248302-1**  
12"W x 48"L x .25"T  
**011296302-1**  
12"W x 96"L x .25"T  
**012448302-1**  
24"W x 48"L x .25"T

**STYLE 304**

**011248304-1**  
12"W x 48"L x .25"T  
**011296304-1**  
12"W x 96"L x .25"T  
**012448304-1**  
24"W x 48"L x .25"T

### COVE

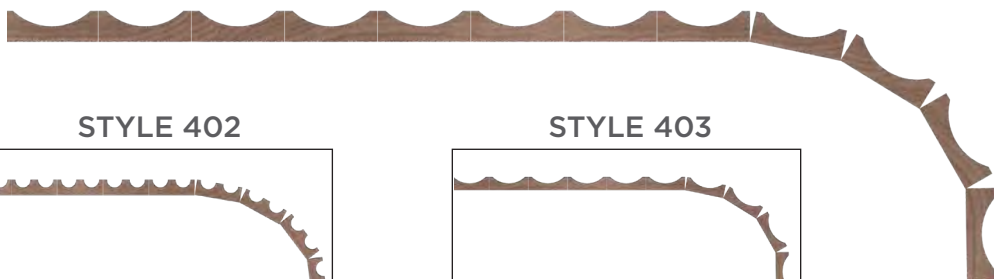

**STYLE 402**

**011248402-1**  
12"W x 48"L x .25"T  
**011296402-1**  
12"W x 96"L x .25"T  
**012448402-1**  
24"W x 48"L x .25"T

**STYLE 403**

**011248403-1**  
12"W x 48"L x .25"T  
**011296403-1**  
12"W x 96"L x .25"T  
**012448403-1**  
24"W x 48"L x .25"T

# FLEXIBLE TAMBOUR PANELS

Made in the USA. Our thin material backer allows Flexible Panels to be used as a wrap as well as flat applications. Flexible beaded panels consist of individual staves, glued to a flexible canvas or paper backer. Suitable for residential and commercial applications. Unfinished American Hardwoods can be easily stained or painted in colors and finishes of your choice.

For **onlay** applications - such as walls, hoods, or cabinet wraps. 48" and 96" lengths in stock. Custom sizes available.

**Stock finishes in: Red Oak (AK), Hard Maple (HM), Paint Grade Poplar (PT), Walnut (WL) & White Oak (WK).**  
To order, refer to the style numbers listed below.

## BEVEL

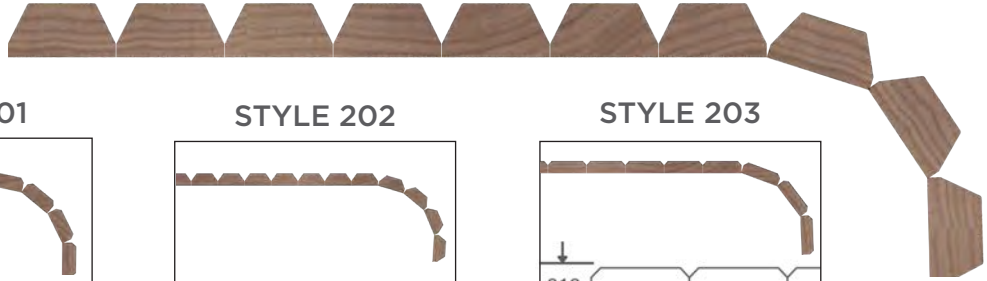

**STYLE 201**

**011248201-1**  
12"W X 48"L X .313"T  
**011296201-1**  
12"W X 96"L X .313"T

**STYLE 202**

**011248202-1**  
12"W X 48"L X .344"T  
**011296202-1**  
12"W X 96"L X .344"T

**STYLE 203**

**011248203-1**  
12"W X 48"L X .313"T  
**011296203-1**  
12"W X 96"L X .313"T  
**012448203-1**  
24"W X 48"L X .313"T  
**012434203-1**  
24"W X 34"L X .313"T

**STYLE 204**

**011248204-1**  
12"W X 48"L X .5"T  
**011296204-1**  
12"W X 96"L X .5"T

**STYLE 206**

**011248206-1**  
12"W X 48"L X .5"T  
**011296206-1**  
12"W X 96"L X .5"T

**STYLE 207**

**011248207-1**  
12"W X 48"L X .75"T  
**011296207-1**  
12"W X 96"L X .75"T



# RIGID PANELS

Multiple styles work with both furniture and architectural applications. Unfinished, ready to stain or paint. **Red Oak (AK), Hard Maple (HM), Paint Grade Brown Maple (PT), Walnut (WL) & White Oak (WK).** 46" and 96" lengths in stock. **Some Styles Available In: Cherry, Alder, Hickory, HDF, Quarter Sawn White Oak & Quarter Sawn Red Oak.**

[Click here for Warranty Disclaimer](#)

## BEAD

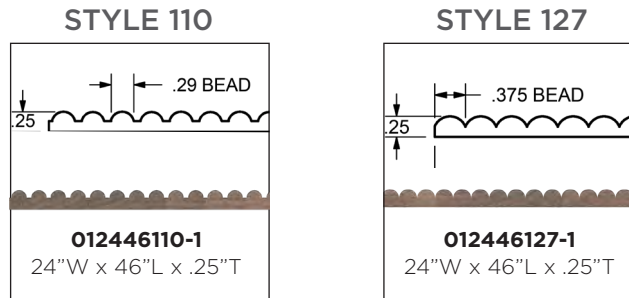
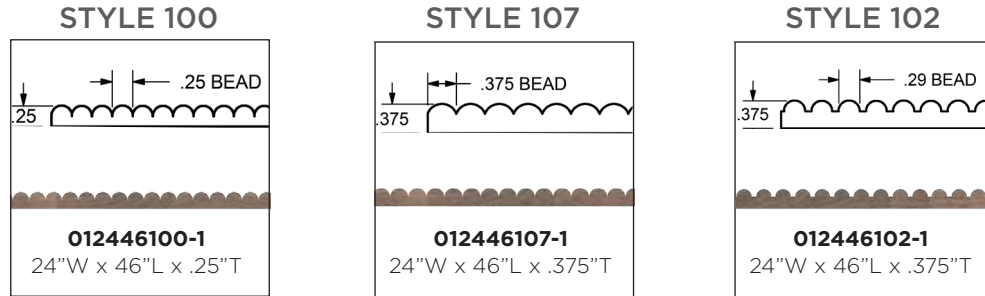

## SQUARE

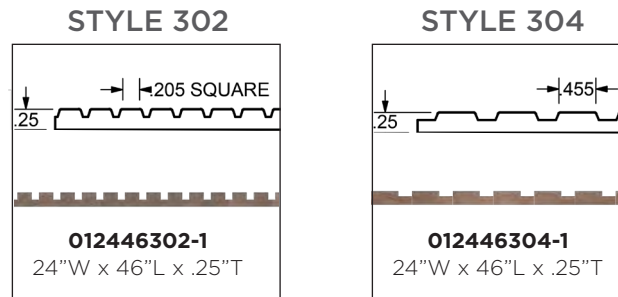

## COVE

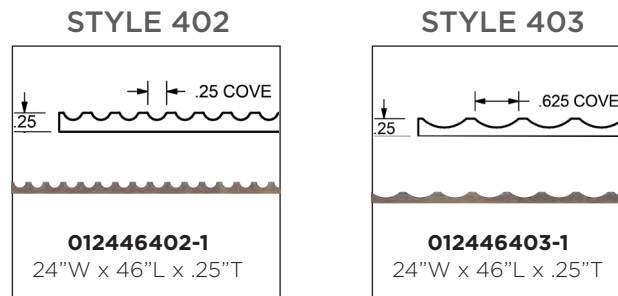

MATERIALS

## NEW! 3/4" T x 96" L x 48" W CROSS-GRAIN VENEER BACKED BEADED PANEL

Full Size Rigid Panels combine tambour texture with engineered stability in a 3/4" panel designed for cabinetry, millwork, and architectural applications.

**Balanced & Stable Construction** - Cross-grain hardwood veneer backer and 1/2" plywood core minimize warping, cupping, and seasonal movement while maintaining strength without excess weight.

**Beaded Face with Visual Texture** - Tambour detailing adds depth and dimension, complementing design styles from traditional to contemporary.

**Standard 3/4" Thickness** - Integrates seamlessly into standard cabinetry and millwork with no special hardware or joinery adjustments.

**Finished Back for Exposed Applications** - Veneer backer provides a clean, finished appearance for islands, open shelving, and freestanding installations.

**Efficient, Cost-Effective Design** - Combines the beauty of solid wood with an engineered core for responsible material use and premium value.

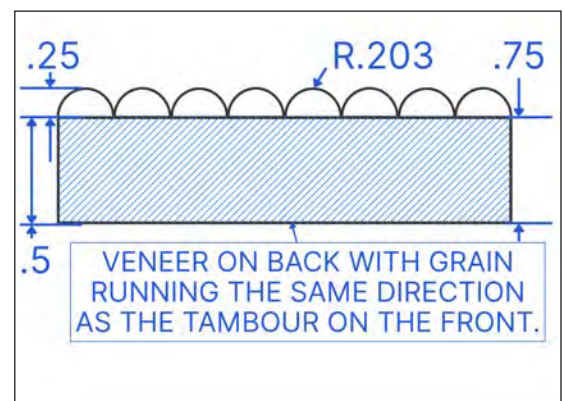

### MATERIALS



# MATERIALS: METAL ACCENT TRIM

Image: .25" x .25" Decorative Bar style #01110810

# METAL ACCENT TRIM



PICTURED: Designer DripEdge® and .25" x .25" Aluminum Bar

## DESIGNER DRIPEDGE®

Fits standard waste can cabinets from 12" to 24".  
Features eased ends and includes pre-applied UHB tape for easy installation.

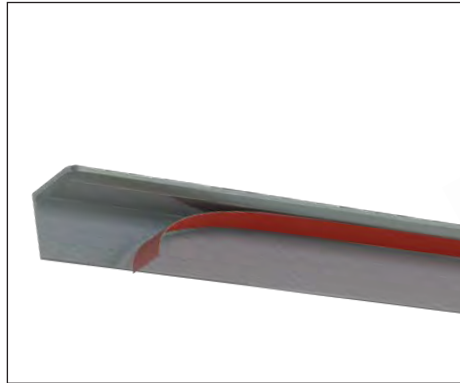
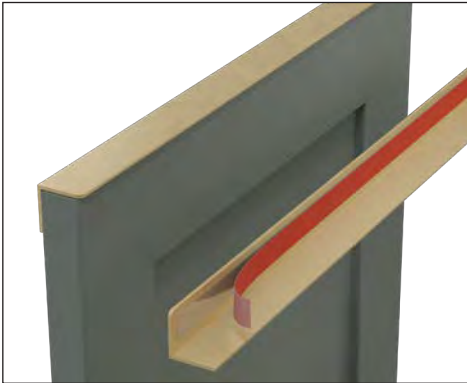

<b>010451-1-1181</b> 11.8125" Long	<b>010451-1-1875</b> 18.75" Long
<b>01110451-1-12</b> 12.75" Long	<b>010451-1-2050</b> 20.50" Long
<b>01110451-1-14</b> 14.50" Long	<b>010451-1-2081</b> 20.8125" Long
<b>010451-1-1481</b> 14.8125" Long	<b>010451-1-2175</b> 21.75" Long
<b>01110451-1-15</b> 15.75" Long	<b>010451-1-2350</b> 23.50" Long
<b>01110451-1-17</b> 17.50" Long	<b>010451-1-2384</b> 23.844" Long
<b>010451-1-1781</b> 17.8125" Long	<b>Sample Kit</b> 01DripEdgeCLR

## ALUMINUM TOUCH-UP PEN



- 01PENWR1**  
Flat Black (WR)
- 01PENBR1**  
Polished Brass (PB)  
& Satin Brass (SB)
- 01PENST1**  
Satin Stainless (ST)
- 01PENTM1**  
Titanium (TM)
- 01PENWB1**  
Warm Bronze (WB)

BA & CR do not have touch-up pens

## UHB TAPE



**01TP50-108**  
1/2" x 108"

**01TP1875-54**  
3/16" x 54"

**01TP50-8**  
1/2" x 8'

**01TP1875-8**  
3/16" x 8'

## ALUMINUM BARS

Available in 72" lengths, the straps can be cut on-site to fit your specifications using a lubricated, non-ferrous, high tooth count carbide blade (96 is recommended) designed for cutting metal. We stock strong, double-sided, clear industrial tape that's temperature resistant to adhere metal trim to mouldings and cabinet panels. Metallic Trim stocked in **Brushed Aluminum (BA)**, **Chrome (CR)**, **Flat Black (WR)**, **Polished Brass (PB)**, **Satin Brass (SB)**, **Satin Stainless (ST)**, **Titanium (TM)** & **Warm Bronze (WB)**.



## ALUMINUM ANGLED BARS

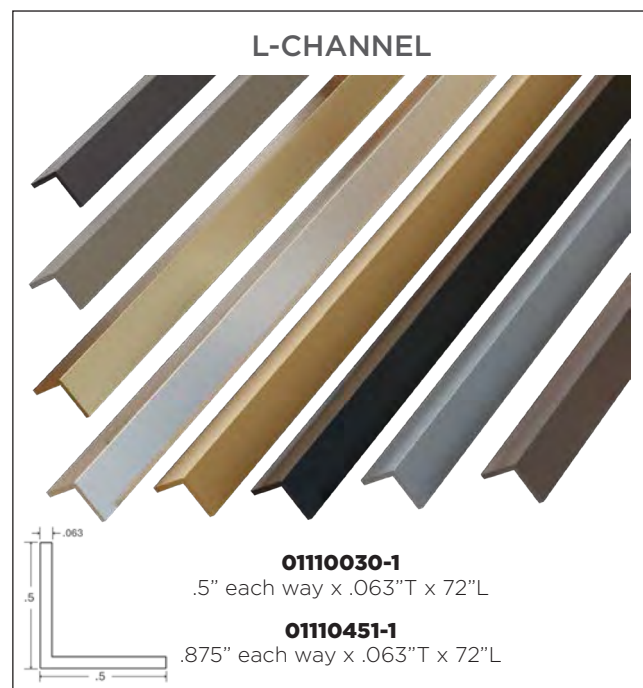

## MATERIALS

**BA:**  
Brushed  
Aluminum

**CR:**  
Chrome

**PB:**  
Polished Brass

**SB:**  
Satin Brass

**ST:**  
Satin Stainless

**TM:**  
Titanium

**WB:**  
Warm Bronze

**WR:**  
Flat Black

# ALUMINUM STRAPPING

Metallic Trim Accents stocked in 72" lengths: **Brushed Aluminum (BA)**, **Chrome (CR)**, **Flat Black (WR)**, **Polished Brass (PB)**, **Satin Brass (SB)**, **Satin Stainless (ST)**, **Titanium (TM)** & **Warm Bronze (WB)**.

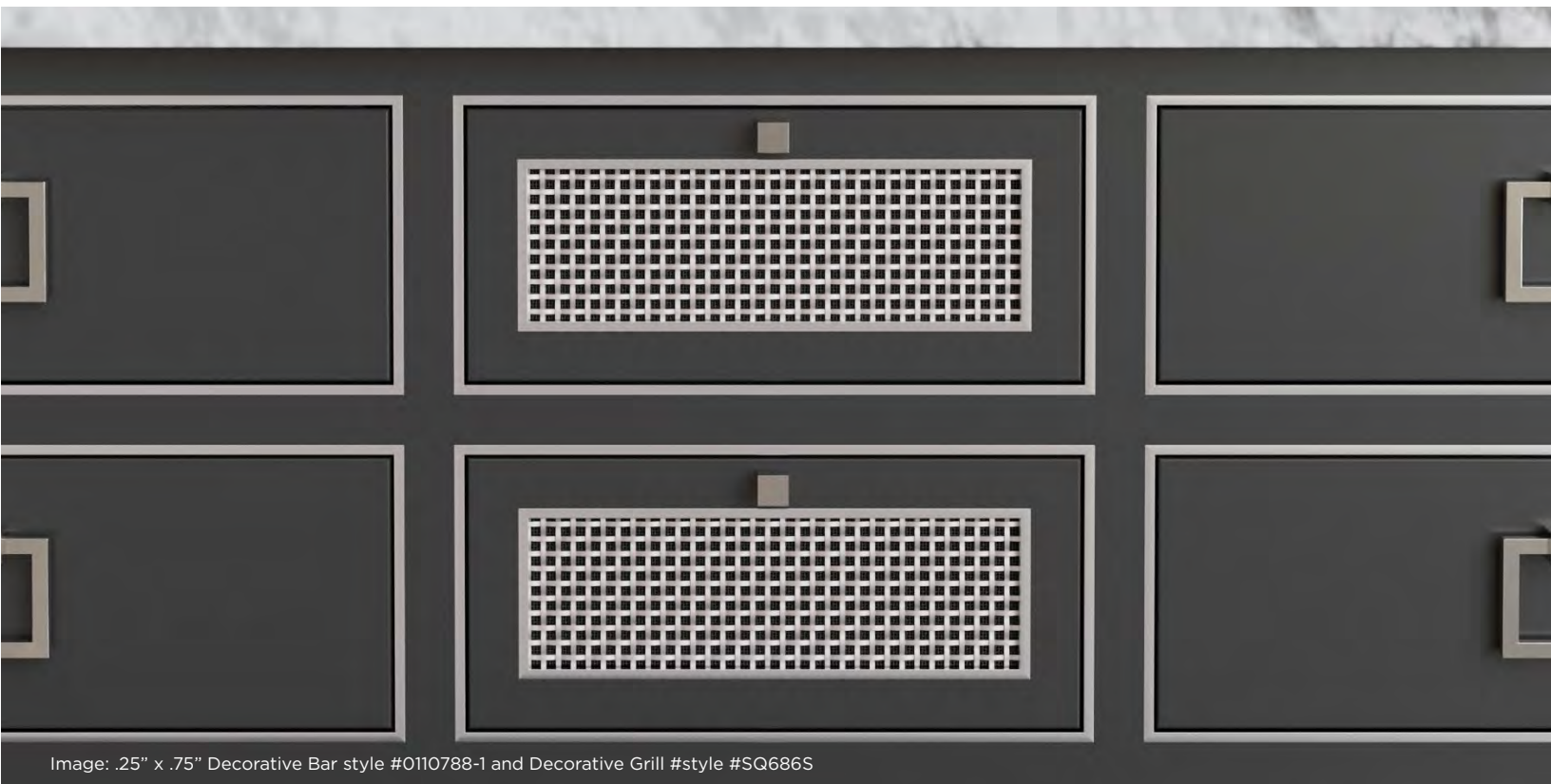
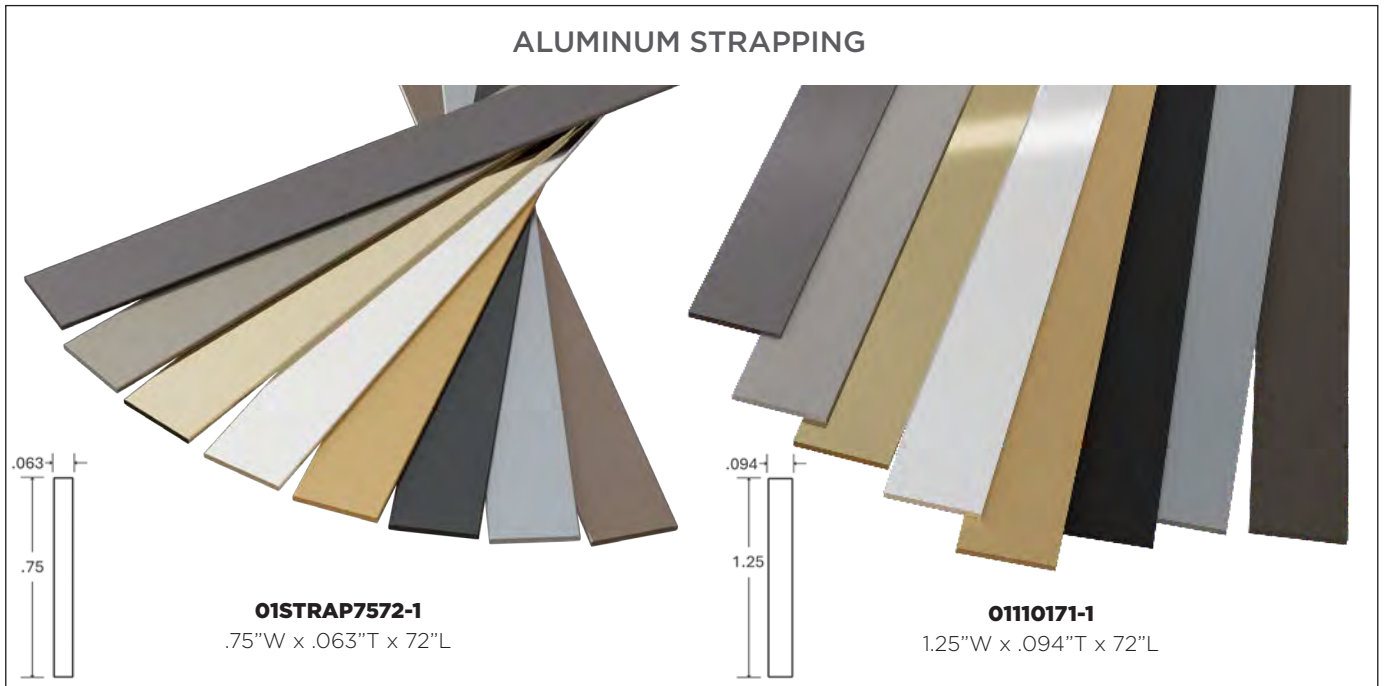

## MATERIALS

10	<b>BA:</b> Brushed Aluminum	<b>CR:</b> Chrome	<b>PB:</b> Polished Brass	<b>SB:</b> Satin Brass	<b>ST:</b> Satin Stainless	<b>TM:</b> Titanium	<b>WB:</b> Warm Bronze	<b>WR:</b> Flat Black
----	--------------------------------	----------------------	------------------------------	---------------------------	-------------------------------	------------------------	---------------------------	--------------------------

## BRASS TRIM COMPONENTS



1/2" Brass Corner Strap in PN #01HC1005-1

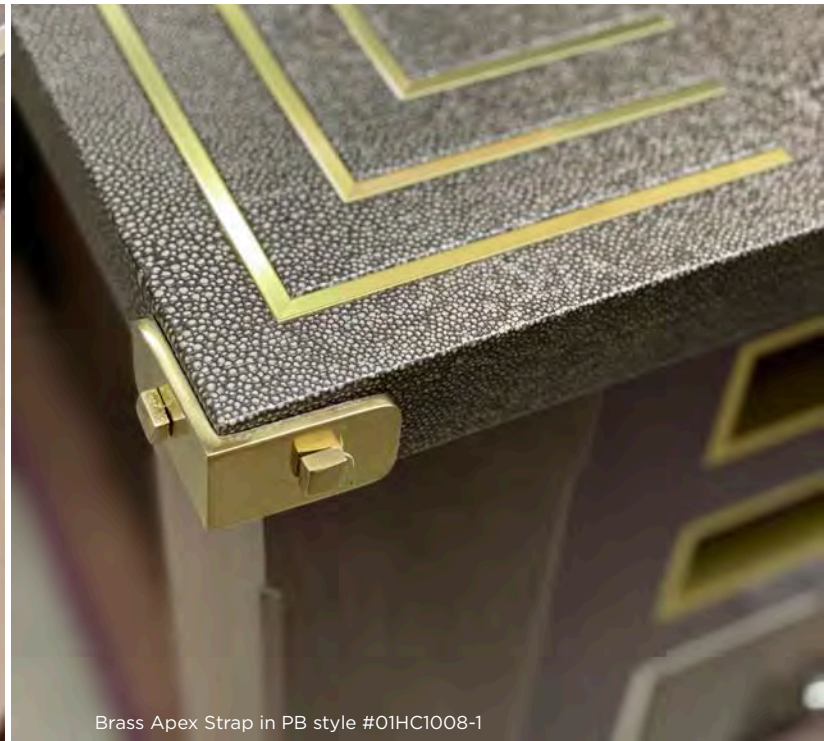

Brass Apex Strap in PB style #01HC1008-1

### 1/2" BRASS CORNER STRAP



**01HC1005-1**  
1.5" Each Way x .08"T  
Available in PB & PN

### 1/2" BRASS STRAP CONNECTOR



**01HC1010-1**  
.512"W x .08"T x 2"L  
Available in PB & PN

### BRASS APEX STRAP



**01HC1008-1**  
2" Each Way x .197"T x 1.181"H  
Available in AB, CR, PB, PN, SB, WR

### 1/4" BRASS BAR

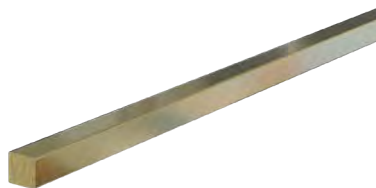

**01990810-1**  
.25" SQ. x 72" L  
Available in PB & SB

### 3/8" BRASS STRAP



**01HC1007-1**  
.375"W x .063"T x 48"L  
Available in PB & PN

## MATERIALS

**AB:**  
Antique Brass

**CR:**  
Chrome

**PB:**  
Polished Brass

**PN:**  
Polished Satin  
Nickel

**SB:**  
Satin Brass

**WR:**  
Flat Black

# MATERIALS: CUT-TO-SIZE



# CUT-TO-SIZE MATERIALS

Sold by the square or linear foot (LF).



Image: Decorative Grille style #332P layered with mesh

Decorative Grilles available in **Antique Brass (AB)**, **Antique Copper (AC)**, **Antique Pewter (AP)**, **Satin Brass (SB)**, **Polished Satin Nickel (SN)**, **Stainless Look (SS)** & **Flat Black (WR)**. Finishes created through an electroplating process. To order Cut-to-Size panels that are ready to install upon delivery, contact us by sending an order form available on our website with your panel specifications and a quote will be provided based on square footage. Sample Kits are available.

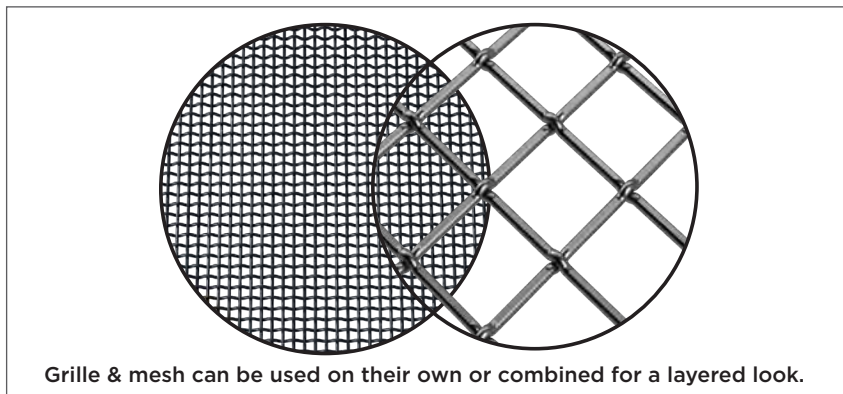

**FINE WIRE MESH**  
Pictured in **Satin Nickel**

- 011848MESH-1**  
18"W x 48"H
- 013624MESH-1**  
36"W x 24"H
- 013648MESH-1**  
36"W x 48"H

Available in **SB, WR, & SN**

## MATERIALS

**AB:**  
Antique Brass

**AC:**  
Antique Copper

**AP:**  
Antique Pewter

**SB:**  
Satin Brass

**SN:**  
Satin Nickel

**SS:**  
Stainless Look

**WR:**  
Flat Black

# DIAMOND DECORATIVE GRILLE

Decorative Grilles are available in **Antique Brass (AB), Antique Copper (AC), Antique Pewter (AP), Natural Aluminum (NA), Satin Brass (SB), Polished Satin Nickel (SN), Stainless Look (SS), Warm Bronze (WB) & Flat Black (WR)** unless otherwise noted. Available Cut-to-Size or as full and half sheets. Custom styles and finishes available upon request.

**NEW!**

**#M22**  
**.375" Flat Crimped Double Diamond**  
 Pictured in **Antique Brass, 2-sided**  
 Front



Back

**013648M22-1** 36"W x 48"H  
**013624M22-1** 36"W x 24"H  
**012472M22-1** 24"W x 72"H  
**011848M22-1** 18"W x 48"H

Available in AB, SB, SN, & WR

**NEW!**

**#226**  
**.05" Flat Rigid Aluminum Grille**  
 Pictured in **Natural Aluminum**



**013648226-1** 36"W x 48"H  
**013624226-1** 36"W x 24"H  
**011848226-1** 18"W x 48"H

Only Available in NA, WB, & WR

**#332P**  
**.75" Multi-Crimp Single Diamond**  
 Pictured in **Antique Pewter**

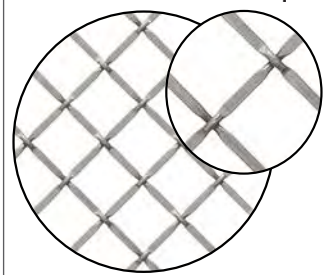

**013648332P-1** 36"W x 48"H  
**013624332P-1** 36"W x 24"H  
**012472332P-1** 24"W x 72"H  
**011848332P-1** 18"W x 48"H

**#CG10**  
**.5" Straight Flat Diamond**  
 Pictured in **Antique Brass**



**013648CG10-1** 36"W x 48"H  
**013624CG10-1** 36"W x 24"H  
**012472CG10-1** 24"W x 72"H  
**011848CG10-1** 18"W x 48"H

**#286S**  
**.375" Flat Single Diamond**  
 Pictured in **Polished Satin Nickel**

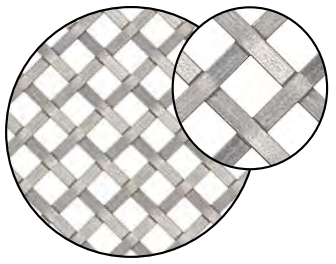

**013648286S-1** 36"W x 48"H  
**013624286S-1** 36"W x 24"H  
**012472286S-1** 24"W x 72"H  
**011848286S-1** 18"W x 48"H

**#DK08**  
**Double-Sided .375" Flat/Fluted**  
 Pictured in **Satin Brass, 2-Sided**

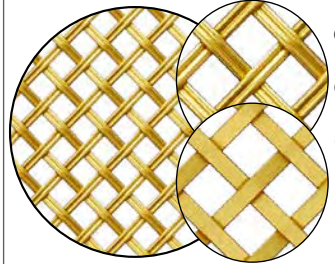

**013648DK08-1** 36"W x 48"H  
**013624DK08-1** 36"W x 24"H  
**012472DK08-1** 24"W x 72"H  
**011848DK08-1** 18"W x 48"H

**#11614P**  
**1" Flat Double Diamond**  
 Pictured in **Flat Black**

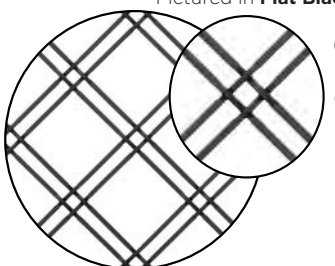

**01364811614P-1** 36"W x 48"H  
**01362411614P-1** 36"W x 24"H  
**01247211614P-1** 24"W x 72"H  
**01184811614P-1** 18"W x 48"H

**#1214F**  
**.5" Round Single Diamond**  
 Pictured in **Antique Copper**

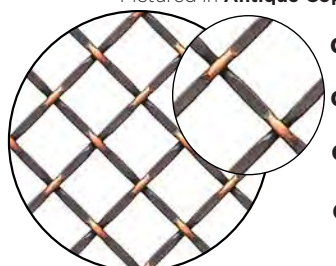

**0136481214F-1** 36"W x 48"H  
**0136241214F-1** 36"W x 24"H  
**0124721214F-1** 24"W x 72"H  
**0118481214F-1** 18"W x 48"H

**#1220T**  
**.5" Chicken Wire**  
 Pictured in **Antique Pewter**

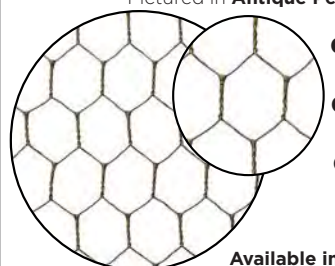

**0136481220T-1** 36"W x 48"H  
**0136241220T-1** 36"W x 24"H  
**0118481220T-1** 18"W x 48"H

Available in AB, AP and WR.

**#R332P**  
**.75" Multi-Crimp Single Diamond with .5" Rosettes**



**013648R332PAB1** 36"W x 48"H  
**013624R332PAB1** 36"W x 24"H  
**011848R332PAB1** 18"W x 48"H

Only Available in Antique Brass

**#R614P**  
**1" Flat Double Diamond w/ .625" Diameter Rosettes**

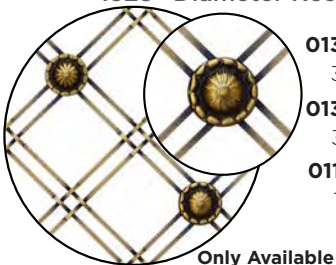

**013648R614PAB1** 36"W x 48"H  
**013624R614PAB1** 36"W x 24"H  
**011848R614PAB1** 18"W x 48"H

Only Available in Antique Brass

**#315C**  
**.75" Pressed Single Diamond**  
 Pictured in **Polished Satin Nickel**



**013648315C-1** 36"W x 48"H  
**013624315C-1** 36"W x 24"H  
**012472315C-1** 24"W x 72"H  
**011848315C-1** 18"W x 48"H

## MATERIALS

# SQUARE DECORATIVE GRILLE

Most Decorative Grilles are available in **Antique Brass (AB)**, **Antique Copper (AC)**, **Antique Pewter (AP)**, **Satin Brass (SB)**, **Polished Satin Nickel (SN)**, **Stainless Look (SS)** & **Flat Black (WR)** unless otherwise noted. Available Cut-to-Size or as whole and half sheets. Custom styles and finishes available upon request.

**#SQ214F**  
**.5" Round Single Diamond**  
 Pictured in **Stainless Look**

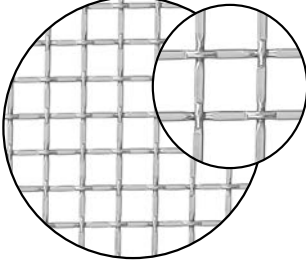

**01SQ3648214F-1**  
 36" W x 48" H  
**01SQ3624214F-1**  
 36" W x 24" H  
**01SQ2472214F-1**  
 24" W x 72" H  
**01SQ1848214F-1**  
 18" W x 48" H

**#SQ286S**  
**.375" Flat Single Diamond**  
 Pictured in **Satin Brass**



**01SQ3648286S-1**  
 36" W x 48" H  
**01SQ3624286S-1**  
 36" W x 24" H  
**01SQ2472286S-1**  
 24" W x 72" H  
**01SQ1848286S-1**  
 18" W x 48" H

**#SQDK08**  
**Double-Sided .375"**  
 Pictured in **Antique Brass**



**01SQ3648DK08-1**  
 36" W x 48" H  
**01SQ3624DK08-1**  
 36" W x 24" H  
**01SQ2472DK08-1**  
 24" W x 72" H  
**01SQ1848DK08-1**  
 18" W x 48" H

**#SQ332P**  
**.75" Multi-Crimp Single Square**  
 Pictured in **Antique Brass**

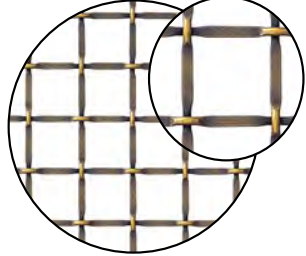

**01SQ3648332P-1**  
 36" W x 48" H  
**01SQ3624332P-1**  
 36" W x 24" H  
**01SQ2472332P-1**  
 24" W x 72" H  
**01SQ1848332P-1**  
 18" W x 48" H

**#SQRE25**  
**.1875" Flat Square**  
 Pictured in **Satin Brass**



**013648RE25-1**  
 36" W x 48" H  
**013624RE25-1**  
 36" W x 24" H  
**012472RE25-1**  
 24" W x 72" H  
**011848RE25-1**  
 18" W x 48" H

Wire Mesh Style #	Cut-to-Size Part #
#M22	M22-1
#226	226-1
#332P	332P-1
#CG10	CG10-1
#286S	286S-1
#DK08	DK08-1
#11614P	11614P-1
#1214F	1214F-1
#1220T	1220T-1
#R332P	R332PAB1
#R614P	R614PAB1
#315C	315C-1
#SQ214F	SQ214F-1
#SQ286S	SQ286S-1
#SQDK08	SQDK08-1
#SQ332P	SQ332P-1
#SQRE25	RE25-1
#MESH	MESH-1

## MATERIALS

**AB:**  
Antique Brass

**AC:**  
Antique Copper

**AP:**  
Antique Pewter

**SB:**  
Satin Brass

**SN:**  
Satin Nickel

**SS:**  
Stainless Look

**WR:**  
Flat Black

## ITALIAN MESH

Made in Italy.

Sold by the linear foot (LF), minimum order of 59" wide x 1 LF.

**NEW!**  
**INTERLACE STRIPE MESH**  
Available in **CP, PB, SS**

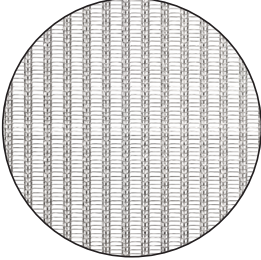

**Style #103**  
01103CP  
01103PB  
01103SS

**NEW!**  
**SUPERFINE WIRE MESH**  
Available in **CP, SB, SS**

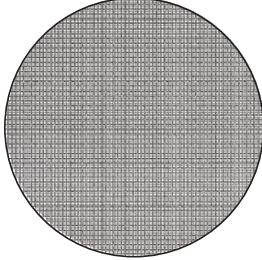

**Style #110**  
01110CP  
01110SB  
01110SS

**CHEVRON MESH**  
Available in **CP, SB, SS**

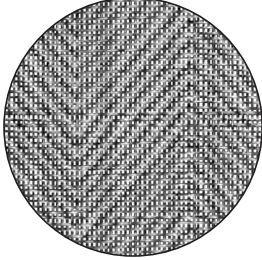

**Style #107**  
01107CP  
01107SB  
01107SS

**JUTE MESH**  
Available in **SS**

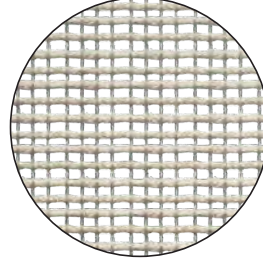

**Style #112**  
01112SS

## RESIN PANELS

Sold by the linear foot (LF), minimum order of 48" wide x 1 LF.

**WHITE LINEN**



**Style #1803**  
011803

**BOTANICAL**



**Style #1804**  
011804

**NATURAL LEAF**



**Style #1802**  
018802

# RATTAN WEBBING

Sold by the linear foot (LF), minimum order of 36" wide x 1 LF.

## NEW! SYNTHETIC RATTAN WEBBING

Our new synthetic rattan webbing combines timeless woven design with modern durability. Manufactured from high-quality polyethylene (PE) granules, this material offers exceptional strength while remaining practically maintenance-free. Unlike natural rattan, it resists fading, warping, or weakening from temperature and humidity changes, ensuring long-lasting structure and performance. 36"W rolls. Available in Natural (NT) or Black (WR).

HEX RATTAN

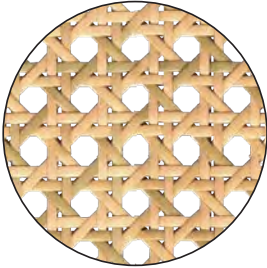

**Style #3202NT**  
013202NT

HEX RATTAN

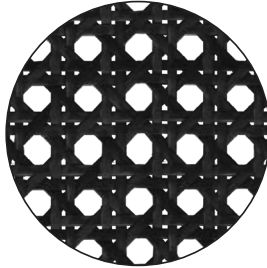

**Style #3202WR**  
013202WR

RADIO WEAVE

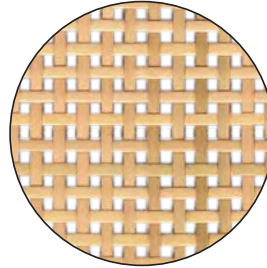

**Style #3201NT**  
013201NT

RADIO WEAVE

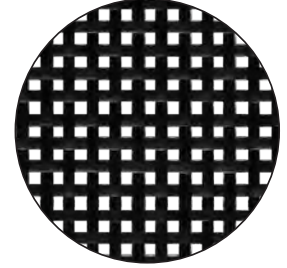

**Style #3201WR**  
013201WR

## NATURAL RATTAN WEBBING

Handwoven from rattan cane, this material offers a lightweight yet durable construction. Over time, it develops a rich patina, adding to its authenticity and charm. Because it is a natural fiber, rattan is responsive to its environment. Gradually, it may stretch, lose some of its original tension, or change shape, particularly in areas exposed to heat, humidity, or fluctuating moisture levels. 36"W rolls.

HEX RATTAN

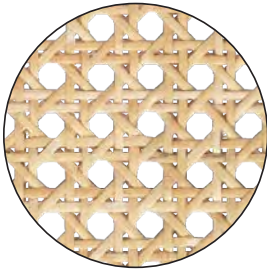

**Style #1202NT**  
011202NT

HERRINGBONE

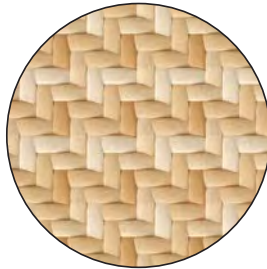

**Style #1203NT**  
011203NT

BASKETWEAVE

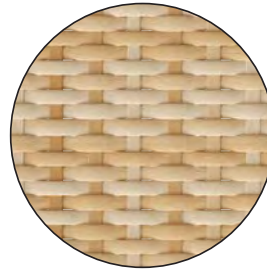

**Style #1204NT**  
011204NT

RADIO WEAVE

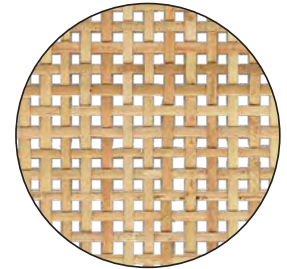

**Style #1201NT**  
011201NT



Image: Hex Rattan Style #3202/#1202

# ECO-FRIENDLY LEATHER

## NEW! PEEL & STICK LEATHER SHEETS

Sold by the linear foot (LF), minimum order of 48" wide x 1 LF.

GRAINED FLAT BLACK



**Style #3216WR**  
013216WR

CROCODILE  
FLAT BLACK



**Style #5618WR**  
015618WR

PEBBLED WALNUT

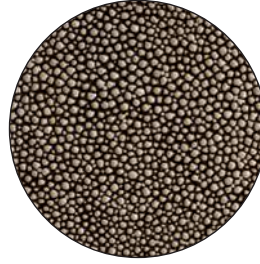

**Style #2652WL**  
012652WL

PEBBLED FLAT BLACK

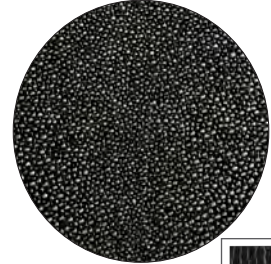

**Style #2652WR**  
012652WR



Adhesive Back

## DOUBLE-SIDED PEBBLED LEATHER PANEL

Sold by the linear foot (LF), minimum order of 48" wide x 1 LF.

BRIGHT WHITE

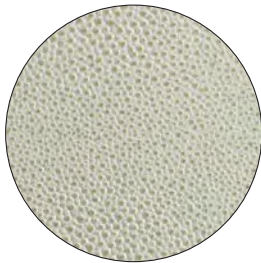

**Style #1652BW**  
011652BW

WALNUT

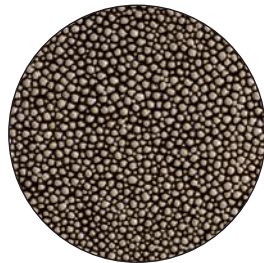

**Style #1652WL**  
011652WL

ESPRESSO

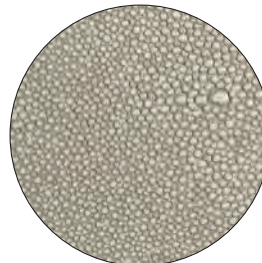

**Style #1652ES**  
011652ES

FLAT BLACK



**Style #1652WR**  
011652WR

## DOUBLE-SIDED GRAINED LEATHER PANEL

Sold by the linear foot (LF), minimum order of 48" wide x 1 LF.

BRIGHT WHITE



**Style #2216BW**  
012216BW

WALNUT



**Style #2216WL**  
012216WL

ESPRESSO



**Style #2216ES**  
012216ES

FLAT BLACK



**Style #2216WR**  
012216WR



# POSTS & TABLE LEGS

Image: Square Island Posts with Chamfered Detail

## 18" - 29" TABLE LEGS



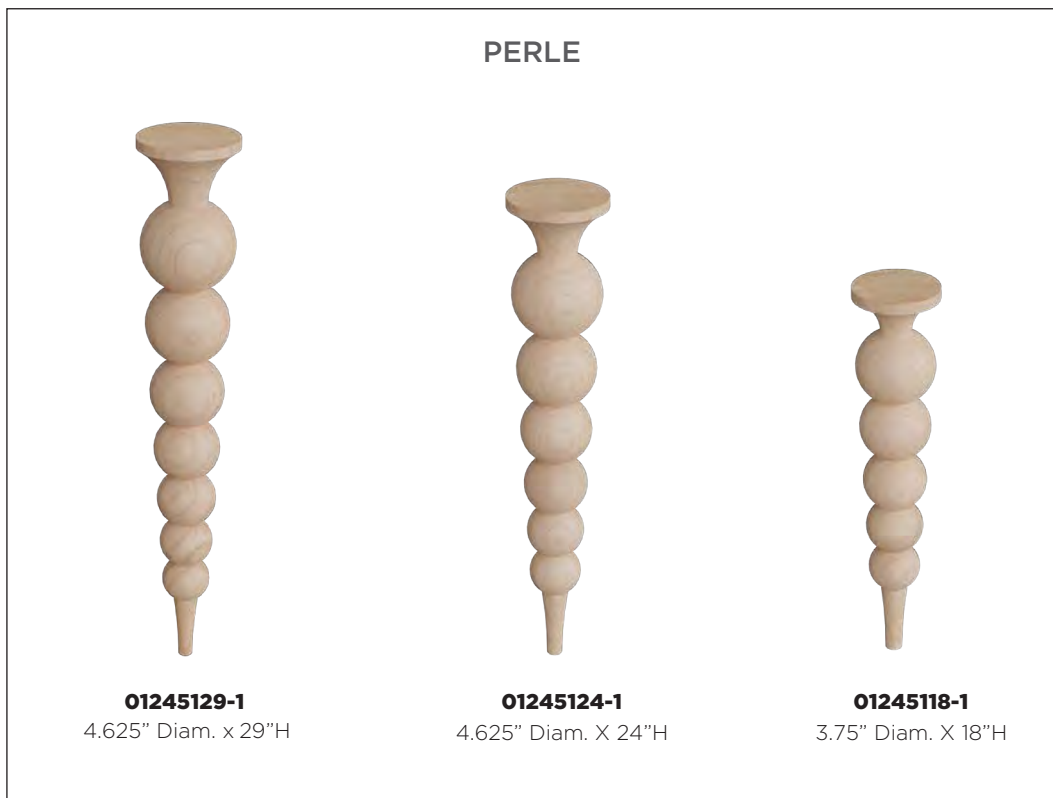
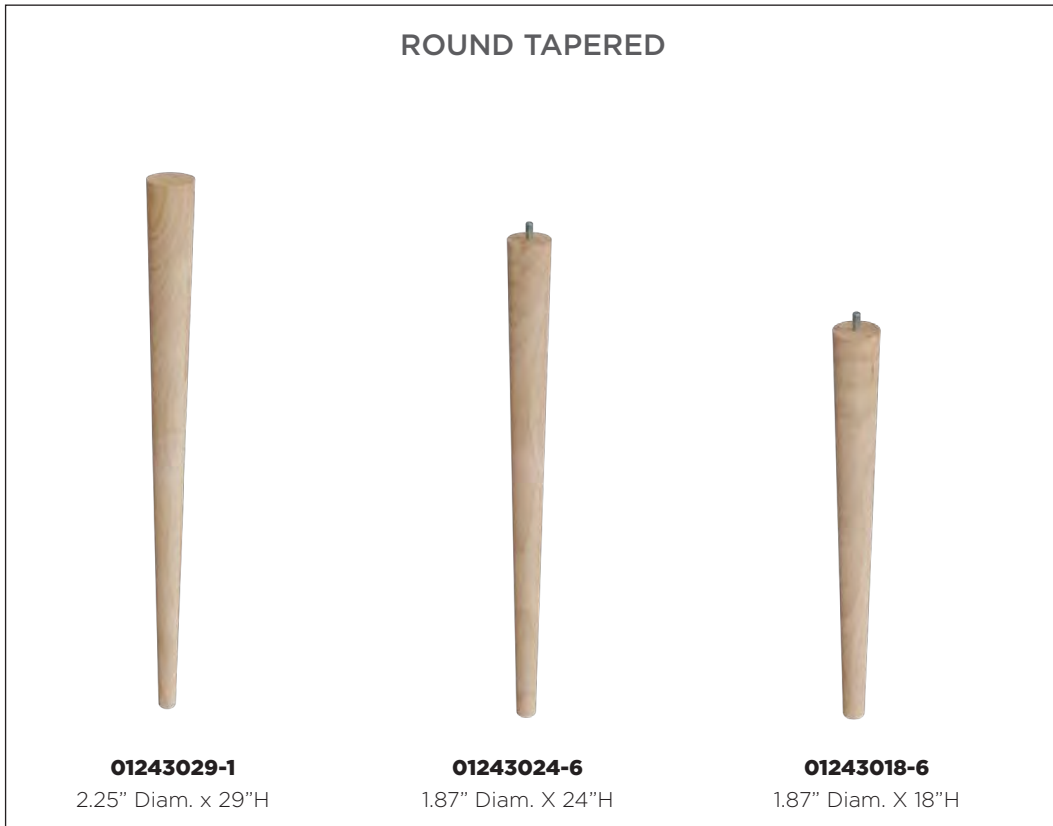

-6: includes a pre-installed 5/16-18 hanger bolt protruding .75" -8: includes hanger bolt and clear-coat semi-gloss finish



## 29" SQUARE TABLE LEGS

-3: indicates notching in the leg

<p><b>2" SQUARE</b></p>  <p><b>01612010-1</b> 2" SQ. x 29"H</p>	<p><b>2" SQUARE NOTCHED</b></p>  <p><b>01612010-3</b> 2" SQ. x 29"H</p>	<p><b>2" SQUARE COLUMN W/ METAL SLEEVE</b></p>  <p><b>01722910-1</b> 2" SQ. x 29"H with 2" SQ. sleeve</p> <p><b>01724529-1</b> 2" SQ. x 29"H with 2"SQ. x 4.5"H sleeve</p>	
--	--	--	--

<p><b>2" SQUARE W/ TAPERED FOOT</b></p>  <p><b>01621025-1</b> 2" SQ. x 29"H</p>	<p><b>2" SQUARE W/ TAPERED FOOT &amp; NOTCH</b></p>  <p><b>01621025-3</b> 2" SQ. x 29"H</p>	<p><b>3" SQUARE</b></p>  <p><b>01613010-1</b> 3" SQ. x 29"H</p>	<p><b>3" SQUARE W/ TAPERED FOOT</b></p>  <p><b>01613025-1</b> 3" SQ. x 29"H</p>
--	--	---	--

### POSTS & LEGS

**AK:**  
Red Oak

**AL:**  
Alder

**CH:**  
Cherry

**HM:**  
Hard Maple

**HK:**  
Hickory

**PT:**  
Paint Grade



**WK:**  
White Oak

**WL:**  
Walnut



## 29" TABLE LEGS

<p><b>3" SQUARE LEG W/ METAL SLEEVE</b></p>  <p><b>01723001-1</b> 3" SQ. x 29"H with 3" SQ. sleeve</p>	<p><b>3" SQUARE LEG W/ METAL SLEEVE</b></p>  <p><b>01734529-1</b> 3" SQ. x 29"H with 3" x 4.5" SQ. sleeve</p>	<p><b>4" SQUARE COLUMN W/ METAL SLEEVE</b></p>  <p><b>01724001-1</b> 4" SQ. x 29"H with 4" SQ. sleeve</p>	<p><b>4" SQUARE</b></p>  <p><b>01614010-1</b> 4" SQ. x 29"H</p>	<p><b>4" SQUARE W/ TAPERED FOOT</b></p>  <p><b>01614025-1</b> 4" SQ. x 29"H</p>
---	--	--	--	--



## 29" TURNED TABLE LEGS

<p><b>ESTATE SQUARE</b></p>  <p><b>01040127-1</b> 2.75" SQ. x 29.25"H  <b>01040160-1</b> 3.75" SQ. x 29.25"H  <b>01220160-1</b> 5" SQ. x 29.25"H</p>			<p><b>KENSINGTON</b></p>  <p><b>01110110-1</b> 3" SQ. x 29"H</p>	<p><b>COUNTRY FRENCH SQUARE</b></p>  <p><b>01060160-1</b> 3.75" SQ. x 29.25"H</p>
---	--	--	--	--

## 29" TURNED TABLE LEGS

COUNTRY FRENCH		GAELIC			ENGLISH COUNTRY	
						
<b>01060110-1</b> 3.75" Diam. x 29.25"H	<b>01510110-1</b> 5" Diam. x 29.25"H	<b>01590122-1</b> 3.5" Diam. x 29"H	<b>01590124-1</b> 4.5" Diam. x 29"H	<b>01590127-1</b> 6" Diam. x 29"H	<b>01000110-1</b> 3.75" Diam. x 29.25"H	<b>01210110-1</b> 5" Diam. x 29.25"H

## MOUNTING PLATES FOR 5/16-18" HANGER BOLTS

<p><b>11-DEGREE ANGLE MOUNTING PLATE</b></p>  <p><b>01ANGLEPLATE</b> 2.375" SQ x .286" T</p>	<p><b>STRAIGHT MOUNTING PLATE</b></p>  <p><b>01STRAIGHTPLATE</b> 2.375" SQ x .286" T</p>	<p><b>HEAVY DUTY PLATE</b></p>  <p><b>01HDPLATE</b> 4.151" x 5.469" x .286" T</p>
---	---	--

## POSTS & LEGS

**AK:**  
Red Oak

**AL:**  
Alder

**CH:**  
Cherry

**HM:**  
Hard Maple

**HK:**  
Hickory

**PT:**  
Paint Grade

**WK:**  
White Oak

**WL:**  
Walnut

## 34.5" - 36.5" SQUARE ISLAND POSTS

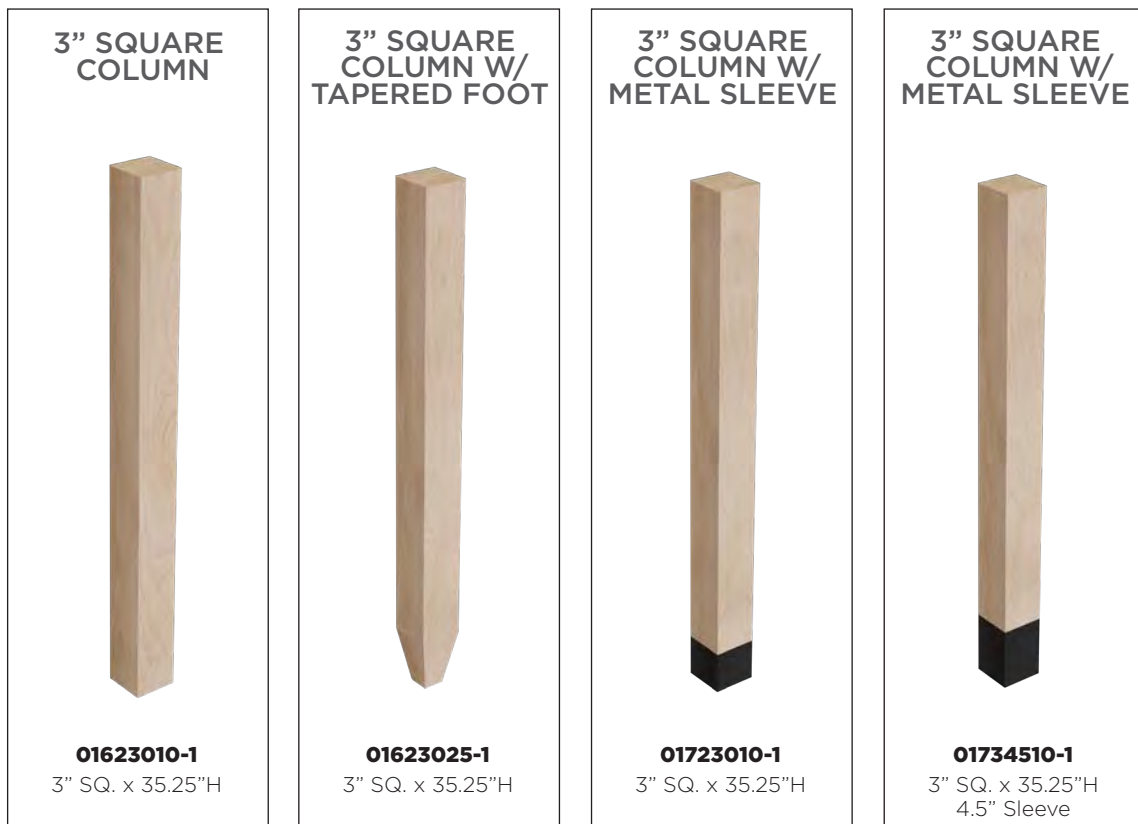
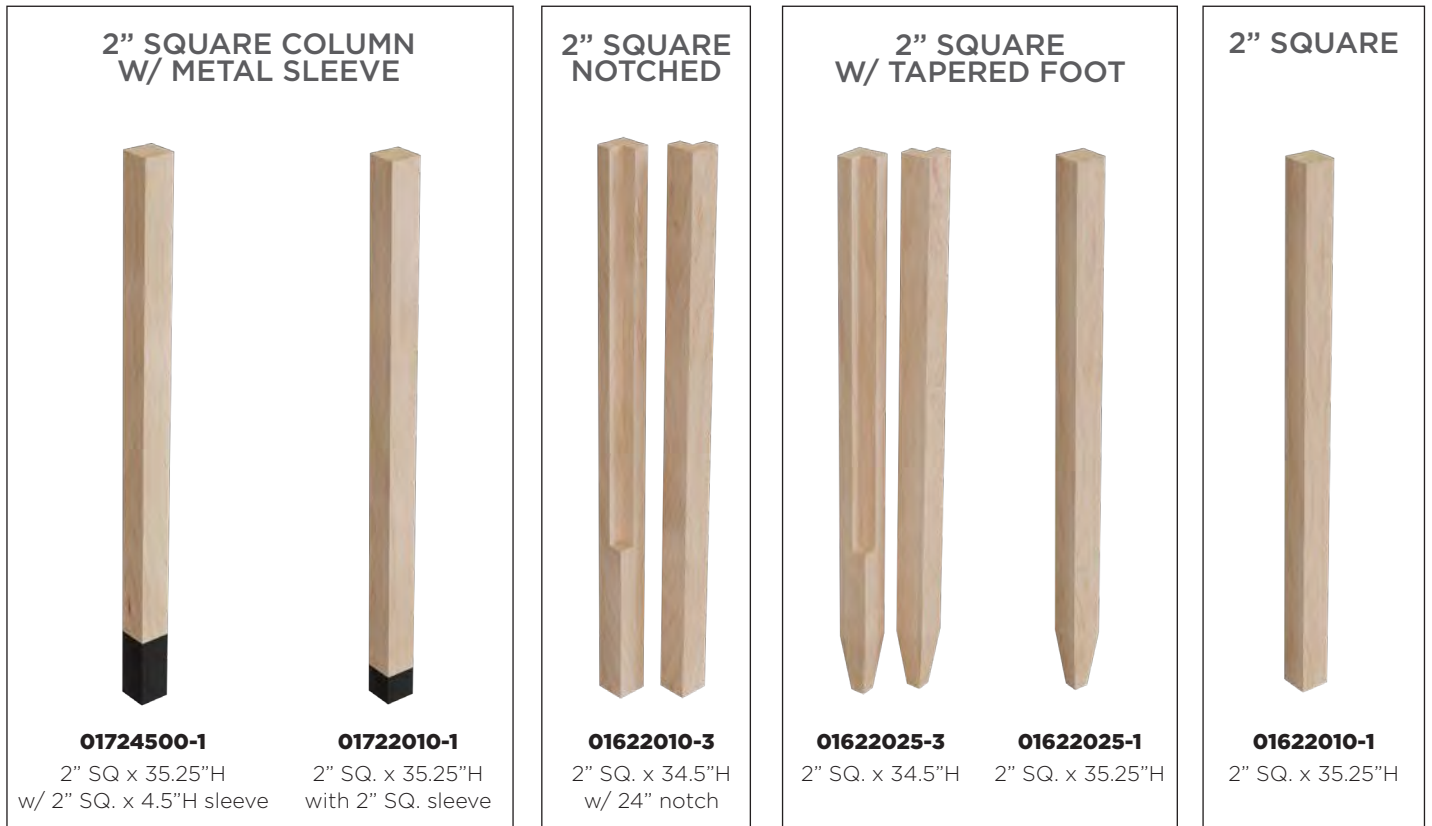

## 34.5" - 36.5" SQUARE ISLAND POSTS



### POSTS & LEGS

**AK:**  
Red Oak

**AL:**  
Alder

**CH:**  
Cherry

**HM:**  
Hard Maple

**HK:**  
Hickory

**PT:**  
Paint Grade



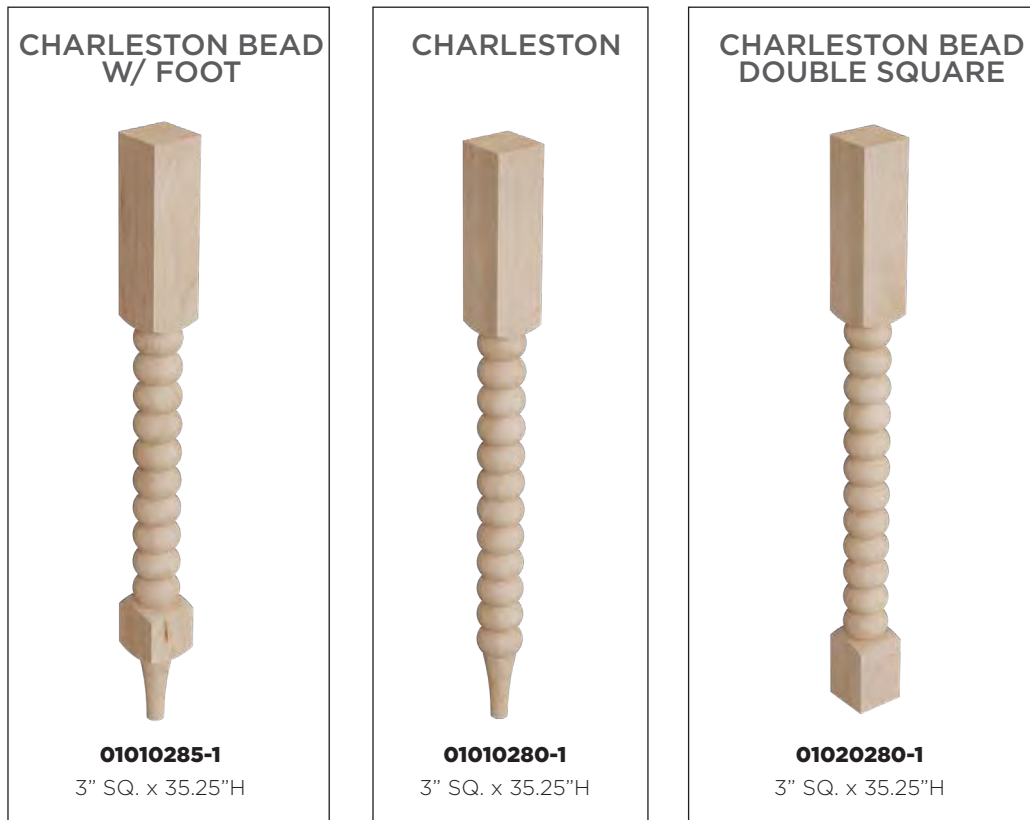

**WK:**  
White Oak

**WL:**  
Walnut

## 34.5" - 36.5" ISLAND POSTS



## 34.5" - 36.5" ISLAND POSTS

<p><b>ENGLISH COUNTRY</b></p>  <p><b>01000210-1</b>      <b>01210210-1</b> 3.75" SQ. x 35.25"H      5" SQ. x 35.25"H</p>	<p><b>ENGLISH COUNTRY DOUBLE SQUARE</b></p>  <p><b>01030210-1</b> 3.75" SQ. x 35.25"H</p>	<p><b>SUMTER DOUBLE SQUARE</b></p>  <p><b>01470210-1</b> 5" SQ. x 35.25"H</p>	<p><b>COUNTRY FRENCH DOUBLE SQUARE</b></p>  <p><b>01410210-1</b> 5" SQ. x 35.25"H</p>
---	--	---	--

<p><b>GAELIC</b></p>  <p><b>01590222-1</b>      <b>01590224-1</b>      <b>01590227-1</b> 3.5" SQ. x 34.5"H      4.5" SQ. x 35.5"H      6" SQ. x 35.5"H</p>			<p><b>GAELIC - ROUTED</b></p>  <p><b>01590223-1</b>      <b>01590225-1</b>      <b>01590228-1</b> 3.5" SQ. x 34.5"H      4.5" SQ. x 35.5"H      6" SQ. x 35.5"H</p>		
---	--	--	---	--	--

### POSTS & LEGS

**AK:**  
Red Oak

**AL:**  
Alder

**CH:**  
Cherry

**HM:**  
Hard Maple

**HK:**  
Hickory

**PT:**  
Paint Grade

**WK:**  
White Oak

**WL:**  
Walnut

## 34.5" - 36.5" ISLAND POSTS

IONIC ACANTHUS



**01520223-1**  
6" SQ. X 35.25"H

WRIGHT



**01040270-1**  
3.5" SQ. x 35.25"H

WRIGHT W/  
DETACHABLE FOOT



Detaches

**01040275-1**  
3.5" SQ. x 35.25"H

KENSINGTON



**01110210-1**  
3" SQ. x 35.25"H

ESTATE SQUARE



**01042760-1**  
2.75" SQ. x 35.25"H



**01040260-1**  
3.75" SQ. x 35.25"H



**01220260-1**  
5" SQ. x 35.25" H

NOUVEAU



**01250210-1**  
3.5" SQ. x 35.25"H

BUNGALOW



**01510228-1**  
3" SQ. x 34.5"H



**01515028-1**  
5" SQ. x 34.5"H

## 34.5" - 36.5" ISLAND POSTS



## 34.5" - 36.5" ISLAND POSTS

<p><b>APEX</b></p>  <p><b>01570217-1</b> 3.5" SQ. x 34.5"H</p>	<p><b>PALLADIAN</b></p>  <p><b>01580217-1</b> 3.5" SQ. x 34.5"H</p>	<p><b>ROMAN CLASSIC</b></p>  <p><b>01082710-1</b>    <b>01080210-1</b>    <b>01230210-1</b> 2.75" SQ. x 35.25"H    3.75" SQ. x 35.25"H    5" SQ. x 35.25"H</p>	<p><b>ROMAN CLASSIC WEAVED</b></p>  <p><b>01080270-1</b> 3.75" SQ. x 35.25"H</p>
---	--	--	---

<p><b>ROMAN CLASSIC FLUTED</b></p>  <p><b>01082740-1</b>    <b>01080240-1</b>    <b>01230240-1</b> 2.75" SQ. x 35.25"H    3.75" SQ. x 35.25"H    5" SQ. x 35.25"H</p>	<p><b>ROMAN CLASSIC ROPED</b></p>  <p><b>01082730-1</b>    <b>01080230-1</b>    <b>01230230-1</b> 2.75" SQ. x 35.25"H    3.75" SQ. x 35.25"H    5" SQ. x 35.25"H</p>	<p><b>TULIP</b></p>  <p><b>01140210-1</b> 3.5" SQ. x 34.5"H</p>
--	--	--

## 34.5" - 36.5" ISLAND POSTS

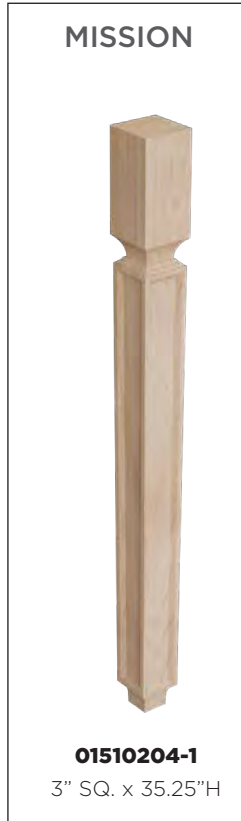

### POSTS & LEGS

**AK:**  
Red Oak

**AL:**  
Alder

**CH:**  
Cherry

**HM:**  
Hard Maple

**HK:**  
Hickory

**PT:**  
Paint Grade

**WK:**  
White Oak

**WL:**  
Walnut

## 41"- 42.25" BAR POSTS

### NOUVEAU



**01250310-1**  
5.5" SQ. x 41"H

### BUNGALOW



**01510328-1**  
3" SQ. x 42.25"H

### 2" SQUARE



**01632010-1**  
2" SQ. x 42.25"H

### 3" SQUARE



**01633010-1**  
3" SQ. x 42.25"H



**01733010-1**  
3" SQ. x 42.25"H  
w/ 3" SQ. sleeve

### 4" SQUARE



**01734010-1**  
4" SQ. x 42.25"H  
w/ 4" SQ. sleeve



**01634010-1**  
4" SQ. x 42.25"H

### 5" & 6" SQUARE



**01735010-1**  
5" SQ. x 42.25"H w/  
5" SQ. sleeve



**01635010-1**  
5" SQ. x 42.25"H



**01636010-1**  
6" SQ. x 42.25"H

## 40.5" - 42.25" BAR POSTS



### POSTS & LEGS

**AK:**  
Red Oak

**AL:**  
Alder

**CH:**  
Cherry

**HM:**  
Hard Maple

**HK:**  
Hickory

**PT:**  
Paint Grade

**WK:**  
White Oak

**WL:**  
Walnut



# END PANELS & BASES

Image: Radiused Base without Toe Kick

# X-PANELS

## TRIMMABLE HARDWOOD X-PANEL

Features 7.5" Trimmable Bottom



**01XPN3025LNG-1**

25"W x 3"T  
x 34.5"H



**01XPN3036LNG-1**

36"W x 3"T  
x 34.5"H



**01XPN1525LNG-1**

25"W x 1.5"T  
x 34.5"H



**01XPN1536LNG-1**

36"W x 1.5"T  
x 34.5"H

## HARDWOOD X-PANEL



**01XPNL3025-1**

25"W x 3"T  
x 34.5"H



**01XPNL3036-1**

36"W x 3"T  
x 34.5"H



**01XPNL1525-1**

25"W x 1.5"T  
x 34.5"H



**01XPNL1536-1**

36"W x 1.5"T  
x 34.5"H

## END PANELS & BASES

**AK:**  
Red Oak

**AL:**  
Alder

**CH:**  
Cherry

**HM:**  
Hard Maple

**WK:**  
White Oak

**WL:**  
Walnut

# X-PANELS

## TRIMMABLE HARDWOOD X-PANEL WITH BACKERS

Features 7.5" Trimmable Bottom



**01XPN3025LNG-4**  
25"W x 3"T  
x 34.5"H



**01XPN3036LNG-4**  
36"W x 3"T  
x 34.5"H



**01XPN1525LNG-4**  
25"W x 1.5"T  
x 34.5"H



**01XPN1536LNG-4**  
36"W x 1.5"T  
x 34.5"H

## HARDWOOD X-PANEL WITH BACKERS



**01XPNL3025-4**  
25"W x 3"T  
x 34.5"H



**01XPNL3036-4**  
36"W x 3"T  
x 34.5"H



**01XPNL1525-4**  
25"W x 1.5"T  
x 34.5"H



**01XPNL1536-4**  
36"W x 1.5"T  
x 34.5"H



Please note:  
Backer and panel  
ship unattached

## STEEL BASES

### STEEL X-BASES



**01XBS3424WR1**  
24"W x 2.362"T x 34.5"H



**01XBS3436WR1**  
36"W x 2.362"T x 34.5"H

## PEDESTAL BASES

### CHARLESTON PEDESTAL



**01290180-1**  
12" Diam. x 29.5"H



**01290280-1**  
12" Diam x 33.5"H

## END PANELS & BASES

**AK:**  
Red Oak

**AL:**  
Alder

**CH:**  
Cherry

**HM:**  
Hard Maple

**WK:**  
White Oak

**WL:**  
Walnut

## RADIUSED BASE



Image: Radiused Base with Toe Kick

**NEW!**

### RADIUS BASE WITH TOE KICK

### RADIUS BASE WITHOUT TOE KICK



**01RADTBS2534-1**

25"W x 9"D x 34.5"H  
w/4.5" Toe Kick Base

**01RADTBS3634-1**

36"W x 9"D x 34.5"H  
w/4.5" Toe Kick Base



**01RADBS2534-1**

25"W x 9"D x 34.5"H

**01RADBS3634-1**

36"W x 9"D x 34.5"H

## KITCHEN ISLAND EXTENSION BASES

Expand both the function and style of your kitchen with our new Kitchen Island Extension Bases. Available in three versatile shapes, these extensions are designed to complement a variety of design styles. Each piece is built with solid hardwood ends for lasting strength and MDF sides for stability, ensuring durability. Easily customizable with your choice of veneer or beaded panels, these extensions allow you to create a seamless look that enhances cabinetry while adding practical workspace or seating.



### BASE SHAPE KITS

Kits Include: (1) Base shape, (2) Hardwood Mounting Plates or End Plugs, \*(2) pcs Tambour, and (1) Cutting Template.



### END PANELS & BASES

**HM:**  
Hard Maple

**MDF:**  
Medium Density  
Fiberboard

**WK:**  
White Oak

**WL:**  
Walnut

## HARDWOOD ISLAND PANELS WITH REMOVABLE CENTERS

Our new hardwood island end panels are designed to bring both flexibility and craftsmanship to kitchen and furniture design. Each panel features a removable center section that allows for easier finishing and unlimited customization. The center panels can be replaced with a variety of materials—including beaded wood, leather, resin, or other decorative inserts—making it simple to tailor the look to match any style or design theme. Call for custom panel quotes.



Pictured: END PANEL 01EPS3036-1

**NEW!**

### END PANEL: SHORT FRAME



**01EPS3025-1**  
25"W x 3"T x 34.5"H  
**01EPS3036-1**  
36"W x 3"T x 34.5"H

### END PANEL: TALL FRAME



**01EPT1525-1**  
25"W x 1.5"T x 34.5"H  
**01EPT1536-1**  
36"W x 1.5"T x 34.5"H  
**01EPT3025-1**  
25"W x 3"T x 34.5"H  
**01EPT3036-1**  
36"W x 3"T x 34.5"H

### END PANEL: ARCH



**01EPAR1525-1**  
25"W x 1.5"T x 34.5"H

# FURNITURE & BUN FEET



Image: Round Tapered Legs

## SPECIALTY FEET

HAND CARVED CENTER PEDESTAL



**01708310-1**  
16"W X 2.5"H

HAND CARVED CORNER PEDESTAL



**01708010-1**  
8.25"W x 8.25"W x 4"H

HAND CARVED  
LEFT & RIGHT PEDESTAL SET



SOLD AS A 2-PC SET  
**01708110-1**  
8.25"W x 4"H

HAMPTON LEFT



**01703110-1**  
6"W x 4.5"H x 1.5"T

HAMPTON CORNER



**01703010-1**  
4.5"H x 1.5"T x 6"L x 6"L

HAMPTON RIGHT



**01703210-1**  
6" W x 4.5" H x 1.5" T

## CARVED BUN FEET

**BELLA SMOOTH**



**01707410-1**  
3.75" DIAM. x 8"H

**BELLA FLUTED**



**01707440-1**  
3.75" DIAM. x 8"H

**SCROLL**



**01709010-1**  
3.25"D. x 3.25"W x 4.5"H

**ACANTHUS CORNER**



**01707710-1**  
3.375" SQ. x 4.5"H



## FURNITURE & BUN FEET

**AK:**  
Red Oak

**AL:**  
Alder

**CH:**  
Cherry

**HM:**  
Hard Maple

**HK:**  
Hickory

**PT:**  
Paint Grade

**WK:**  
White Oak

**WL:**  
Walnut

## SQUARE TURNED BUN FEET

NOUVEAU



**01700457-1**  
4" SQ. x 4"H

**01700459-1**  
3.25" SQ. x 4"H

METRO



**01705710-1**  
4" SQ. x 4.5"H

TULIP SQUARE



**01706065-1**  
3.5" SQ. x 4.625"H

SUMMIT



**01705080-1**  
4" SQ. x 4.5"H

LILLE SQUARE



**01750460-1**  
4" SQ. x 4"H

**01704060-1**  
4" SQ. x 4.5"H

EMPIRE



**01700146-1**  
3" SQ. x 4.5"H

KENSINGTON



**01703510-1**  
3" SQ. x 4.5"H

LIAM



**01700627-1**  
4.62" SQ. x 6"H

SQUARE COLUMN BASE



**01705860-1**  
6" SQ. x 4.5"H

SHAKER



**01705715-1**  
4.5" SQ. x 4.5"H

# SQUARE & SQUARE TAPERED FURNITURE & BUN FEET

**CRAFTSMAN CORNER**



**01705175-1**  
3.75"W x 3.75"W x 6"H

**SQUARE TAPERED**



**01705610-1**  
1.875" SQ. x 6"H

**SQUARE CRAFTSMAN**



**01705112-1**  
3" SQ. x 6"H

**SQUARE COLUMN BASE**



**01705510-1**  
3.75" SQ. x 4"H

**01705810-1**  
5" SQ. x 5"H

**TAPERED**



**01705225-1**  
3.5" SQ. x 4.5"H

**WRIGHT**



**01704075-1**  
3" SQ. x 4.5"H  
(6.5" overall height)

**STRATFORD**



**01705110-1**  
2.375" SQ. x 6"H

**10" TALL SQUARE LEG W/ METAL SLEEVE**



**01731010-1**  
3" SQ. x 10"H

**2" SQUARE LEG W/ TAPER**



**01700210-1**  
2" SQ. x 10"H

**3" SQUARE LEG W/ TAPER**



**01700310-1**  
3" SQ. x 10"H

## FURNITURE & BUN FEET

**AK:**  
Red Oak

**AL:**  
Alder

**CH:**  
Cherry

**HM:**  
Hard Maple

**HK:**  
Hickory

**PT:**  
Paint Grade

**WK:**  
White Oak

**WL:**  
Walnut

## TOE KICK FEET

TULIP



**01706060-1**

4"W x 2.5"T x 4.625"H

PALLADIAN



**01700018-1**

4"W x 2.5"T x 4.5"H

APEX



**01705155-1**

2.5" SQ. x 4"H



**01705150-1**

2.75" SQ. x 4"H

TOE KICK FOOT W/ 4.5" METAL SLEEVE



**01700245-1**

**01700245-6**

2" SQ. x 4.5"H



**01700345-1**

**01700345-6**

3" SQ. x 4.5"H

-6: includes a pre-installed 5/16-18 hanger bolt protruding .75"



## ROUND TURNED BUN FEET

### CLASSIC



**01705310-1**

3.625" DIAM. x 4.5"H

### CRAFTSMAN



**01760410-1**

3.625" DIAM. x 4"H



**01704210-1**

3.625" DIAM. x 4.5"H

### TULIP



**01706010-1**

3.5" DIAM. x 4.625"H

### COUNTRY FRENCH



**01702510-1**

3.625" DIAM. x 4"H



**01700015-1**

3.875" DIAM. x 4.5"H

### MADISON



**01704110-1**

3" DIAM. x 6.125"H

### AIDEN



**01700327-1**

3.625" DIAM. x 4.5"H

### LILLE



**01704010-1**

4" DIAM. x 4.5"H

### LILLE FLUTED



**01704040-1**

4" DIAM. x 4.5"H

### OXFORD



**01704910-1**

4" DIAM. x 4.5"H

## FURNITURE & BUN FEET

**AK:**  
Red Oak

**AL:**  
Alder

**CH:**  
Cherry

**HM:**  
Hard Maple

**HK:**  
Hickory

**PT:**  
Paint Grade

**WK:**  
White Oak

**WL:**  
Walnut

## 6" & 9" FURNITURE FEET

-6: Includes a pre-installed 5/16-18 hanger bolt protruding .75" -8: Includes hanger bolt and clear coat semi-gloss finish.

**ROUND TAPERED LEGS W/ FERRULE**

**01240006-1**  
**01240006-6**  
1.5" DIAM. x 6" H

**01240009-1**  
**01240009-6**  
1.87" DIAM. x 9" H

**SQUARE TAPERED LEGS W/ FERRULES**

**01241006-1**  
**01241006-6**  
1.5" SQ. x 6" H

**01241009-1**  
**01241009-6**  
1.87" SQ. x 9" H

**TIPTOE W/ FERRULE**

**01242006-1**  
**01242006-6**  
2.75" DIAM. x 6" H

**01242009-1**  
**01242009-6**  
3.625" DIAM. x 9" H

**ROUND TAPERED FEET W/ BRASS SLIPPER CUP**

**01221006-6**  
2" DIAM. x 6" H

**01221009-6**  
2.6875" DIAM. x 9" H

**SQUARE TAPERED FEET W/ BRASS SLIPPER CUP**

**01222006-6**  
2.625" DIAM. x 6" H

**CALLA FEET W/ BRASS SLIPPER CUP**

**01223006-6**  
2.5" DIAM. x 6" H

**01223009-6**  
2.5" DIAM. x 9" H

**PERLE**

**01245106-1**  
**01245106-6**  
2.25" DIAM. x 6" H

**01245109-1**  
**01245109-6**  
**01245109-8**  
2.75" DIAM. x 9" H

**ROUND TAPERED**

**01243006-1**  
**01243006-6**  
**01243006-8**  
1.5" DIAM. x 6" H

**01243009-1**  
**01243009-6**  
1.87" DIAM. x 9" H

**SQUARE TAPERED**

**01244006-1**  
**01244006-6**  
1.5" SQ. x 6" H

**01244009-1**  
**01244009-6**  
1.87" SQ. x 9" H

### FURNITURE & BUN FEET

## CHROME

ANGLE ROUND



**01700400CR1**

2.813" PLATE x 5.375"D  
x 4.875"H

5" SQUARE  
CORNER



**01700402CR1**

4" SQ. x 5"H

ROUND CORNER



**01700012CR1**

4.134" PLATE x 5.906"D  
x 6"H

STRAIGHT  
ROUND



**01700905CR1**

3.5" DIAM. x 4"H

## SOLID BRASS

RUTLAND



**01700408-1**

4.969"W X 7.189"H

DEVON



**01700406-1**

1.44"W X 5.906"H

ESSEX



**01700412-1**

2"W X 5.5"H  
w/3"X3" plate

TYNE



**01700410-1**

2.106"W X 5.875"H  
w/2" plate

BRISTOL



**01700401WR1**

1.17"W X 6.18"H  
w/4x4 plate

4" APEX



**01704017-1**

3.75"W X 4"H

APEX VASA



**01706018-1**

4.724"W X 5.906"H

FURNITURE & BUN FEET

**AB:**  
Antique Brass

**CR:**  
Chrome

**PB:**  
Polished Brass

**SB:**  
Satin Brass

**WR:**  
Flat Black

## ALUMINUM SLEEVES AND FERRULES

### SQUARE METAL FERRULES

Pictured in Brushed Aluminum

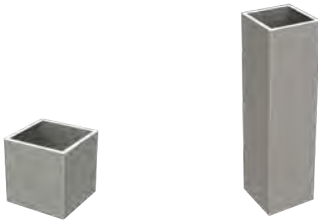

**01FRS1010-1**

1" SQ. OUTER DIM.  
x .125"T x 1"H

**01FRS1254-1**

1.25" SQ. OUTER DIM.  
x .125"T x 4"H

### ROUND METAL FERRULES

Pictured in Brushed Aluminum



**01FRC1010-1**

.913" OUTER DIAM.  
x .125"T x 1"H

**01FRC1040-1**

.913" OUTER DIAM.  
x .125"T x 4"H

### TOE KICK METAL SLEEVES

Pictured in Chrome



**01SLV245-1**

2" SQ. OUTER DIM.  
x .125"T x 4.5"H

**01SLV345-1**

3" SQ. OUTER DIM.  
x .125"T x 4.5"H

### ALUMINUM SLEEVES



**01SLV2-1**

2" SQ. OUTER DIM.  
x .125"T x 2"H



**01SLV3-1**

3" SQ. OUTER DIM.  
x .125"T x 3"H



**01SLV4-1**

4" SQ. OUTER DIM. x  
.125"T x 4"H



**01SLV5-1**

5" SQ. OUTER DIM.  
x .125"T x 5"H  
BA & WR Only

**BA:**  
Brushed  
Aluminum

**CR:**  
Chrome

**GL:**  
Soft Gold

**PB:**  
Polished Brass

**SB:**  
Satin Brass

**ST:**  
Satin Stainless

**WB:**  
Warm Bronze

**WR:**  
Flat Black

## BRASS SLIPPER CUPS

### SOLID BRASS SLIPPER CUPS

Pictured in Chrome



**01SLPR106-1**

1.59" SQ. X 1.89"H



**01SLPR105-1**

1.26" DIAM. X 2.165"H



**01SLPR104-1**

1.154" DIAM. X 1.87"H

### FURNITURE & BUN FEET

**AB:**  
Antique Brass

**CR:**  
Chrome

**PB:**  
Polished Brass

**SB:**  
Satin Brass

**WR:**  
Flat Black



# BRACKETS & CORBELS

Image: Lexington Bracket & Gallery Rail

# BRACKETS

## NEW! BRASS BRACKETS

Knurled & Plain Styles Available

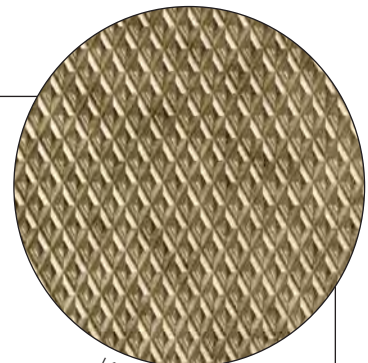

Knurled Texture



**01NARCHKNLD75-1**

Knurled  
7.5"D X 10"H X 1"W



**01WARCHKNLD75-1**

Knurled  
7.5"D X 10"H X 1"W



**01WARCHPLN75-1**

7.5"D X 10"H X 1"W



**01NARCHPLN75-1**

7.5"D X 10"H X 1"W

## BAUHAUS BRACKET

Check Website for Arch Finishes



**01600016-1**

2.125"W x 9"D x 12"L

**01600006-1**

2.125"W x 7"D x 9"L

## MID-CENTURY TRIANGLE BRACKET

Check Website For Finishes



**01651270-1**

.75"W X 12.625"D X 6.875"H

# BRACKETS

## LEXINGTON BAR BRACKET



**01605006-1**  
2.5"W x 10"D x 5"L



**01605007-1**  
1.5"W x 10"D x 5"L



**01605008-1**  
2.5"W x 10"D x 7.5"L



**01605009-1**  
1.5"W x 10"D x 7.5"L

## CONTOUR BRACKET



**01600300-1**  
2.5" W x 9" D x 9" L

## ARTS & CRAFTS BRACKET



**01607012-1**  
5" W x 7.5" D x 11.5" L

## BRACKETS & CORBELS

**AK:**  
Red Oak

**AL:**  
Alder

**CH:**  
Cherry

**HM:**  
Hard Maple

**HK:**  
Hickory

**PT:**  
Paint Grade

**WK:**  
White Oak

**WL:**  
Walnut

## CORBELS

**NEW!** CONTEMPORARY CORBEL WITH METAL\* / LEATHER\* ACCENTS



**01600001-1**  
3"W x 6"D x 12"L



**01600002-1**  
4.5"W x 18"D x 12"L



**01600003-1**  
4.5"W x 8"D x 34.5"L

PORTRAIT CORBEL



**01600009-1**  
3" W x 8" D x 12" L

TRIAD CORBEL-NARROW



**01607009-1**  
2.875" W x 9" D x 12" L



**01607008-1**  
2.875" W x 7" D x 9" L

TRIAD CORBEL



**01607006-1**  
7.5" W x 6" D x 8.375" L



**01607007-1**  
3.75" W x 4" D x 5.5" L

## CORBELS

### PLAIN NOUVEAU CORBEL



**01601400-1**

5.5" W x 9" D x 13" L



**01601300-1**

5.5" W x 2.75" D x 13" L



**01601100-1**

3.5" W x 3.875" D x 6.831" L

### SIMPLICITY CORBEL



**01607004-1**

5.5" W x 6.875" D x 7.5" L



**01607001-1**

4.5" W x 5.75" D x 5" L



**01607005-1**

3.5" W x 4.125" D x 4.5" L

## BRACKETS & CORBELS

**AK:**  
Red Oak

**AL:**  
Alder

**CH:**  
Cherry

**HM:**  
Hard Maple

**HK:**  
Hickory

**PT:**  
Paint Grade

**WK:**  
White Oak

**WL:**  
Walnut

## CORBELS

### APEX CORBEL



**01607117-1**

3"W X 3.875"D X 7"L

**01607217-1**

3.875" W x 5" D x 8.75" L

**01607317-1**

6" W x 8" D x 14" L

### REVIVAL CORBEL



**01604510-1**

3.75" W x 9" D x 14" L

**01604505-1**

3.75" W x 9" D x 9" L

### SHAKER CORBEL



**01606002-1**

3.875" W x 3.5" D x 6.75" L

**01606001-1**

5.25" W x 6.75" D x 13.25" L

**01606003-1**

6.625" W x 7.5" D x 16" L

# CORBELS

## CRAFTSMAN CORBEL



**01608009-1**  
2.75" W x 6" D x 10" L



**01608007-1**  
1.5" W x 8" D x 12" L



**01608010-1**  
3.5" W x 8" D x 12" L



**01608008-1**  
3.5" W x 8" D x 12" L

## PETITE CRAFTSMAN CORBEL



**01608001-1**  
1.25" W x 1.5" D x 3" L

## MISSION CORBEL



**01601205-1**  
5.75" W x 3.875" D x 9" L



**01601204-1**  
3.5" W x 3.5" D x 13" L



**01601203-1**  
3.5" W x 9" D x 13" L

## BRACKETS & CORBELS

**AK:**  
Red Oak

**AL:**  
Alder

**CH:**  
Cherry

**HM:**  
Hard Maple

**HK:**  
Hickory

**PT:**  
Paint Grade

**WK:**  
White Oak

**WL:**  
Walnut

## CORBELS

### ARTS & CRAFTS CORBEL



**01607010-1**

4.5" W x 7.5" D x 14" L



**01607011-1**

3.75" W x 5.813" D x 9" L

### PINNACLE CORBEL



**01607316-1**

9" W x 7.25" D x 12" L



**01607216-1**

5.5" W x 5" D x 8" L

### HAND CARVED GRAPE CORBEL



**01901005-1**

5.5" W x 7" D x 15" L



**01901003-1**

3.5" W x 8" D x 13" L

### MADLINE CORBEL



**01607315-1**

4" W x 9.5" D x 14" L



**01607215-1**

2.5" W x 6.125" D x 8" L

# CORBELS

**ACANTHUS CORBELS**

01901105-1  
3.5" W x 8" D x 13" L

01901001-1  
7.875" W x 6" D x 14.5" L

01901002-1  
5" W x 4.5" D x 12" L

**ACANTHUS CORBELS**

01901108-1  
6.5" W x 2.5" D x 15" L

01901107-1  
3" W x 1.323" D x 6" L

01901009-1  
3" W x 1.75" D x 4.5" L  
SOLD AS 2-PC SET

**GAELIC CORBEL**

01600928-1  
4.75" W x 5.75" D x 9" L

01600628-1  
3.5" W x 3.875" D x 6.625" L

## BRACKETS & CORBELS

**AK:**  
Red Oak

**AL:**  
Alder

**CH:**  
Cherry

**HM:**  
Hard Maple

**HK:**  
Hickory

**PT:**  
Paint Grade

**WK:**  
White Oak

**WL:**  
Walnut

## CORBELS

### CORINTHIAN CORBEL



**01605001-1**

4.75" W x 5.5" D x 9.625" L



**01605000-1**

3.875" W x 3" D x 8" L



**01605005-1**

3.5" W x 7" D x 14" L

### CORINTHIAN CORBEL



**01904991-1**

3.75" W x 8.5" D x 13" L



**01904990-1**

2.625" W x 2.5" D x 4.5" L



**01901004-1**

5.25" W x 4.5" D x 12.5" L



**01904993-1**

3.75" W x 8.5" D x 13" L

## CORBELS

### CELTIC CORBEL



**01601427-1**

5.5" W x 7.125" D x 14" L

**01600927-1**

4.75" W x 5.75" D x 9.5" L

**01600627-1**

3.5" W x 3.875" D x 6.625" L

### PALLADIAN CORBEL



**01600318-1**

3" W x 3.875" D x 7" L



Image: Mid-Century Triangle Bracket w/ Flat Shelves

## BRACKETS & CORBELS

**AK:**  
Red Oak

**AL:**  
Alder

**CH:**  
Cherry

**HM:**  
Hard Maple

**HK:**  
Hickory

**PT:**  
Paint Grade

**WK:**  
White Oak

**WL:**  
Walnut



# CREATE-A-COLUMN™ HALF ROUND MOULDINGS & RADIUSED CORNER MOULDINGS

Image: Plain Half Round Moulding - Series 150

## NEW! RADIUSED CORNER MOULDINGS

Add elegance and dimension to your cabinetry and furniture with our MDF Radiused Corner Mouldings. Featuring softly curved lines inspired by Art Deco design, these mouldings bring a refined, detail to any project. Crafted from high-quality MDF, they are supplied unfinished, ready to be painted or veneered.



Radiused Corner Without Toe Kick

Radiused Corner With 3" Toe Kick



\*Available in MDF only. Hardwood coming soon.

CREATE-A-COLUMN™

**AL:**  
Alder

**AK:**  
Red Oak

**CH:**  
Cherry

**HM:**  
Hard Maple

**MDF:**  
Medium Density  
Fiberboard

**QS:**  
Quarter Sawn  
White Oak

**WK:**  
White Oak

# CREATE-A-COLUMN™ & HALF ROUND MOULDINGS

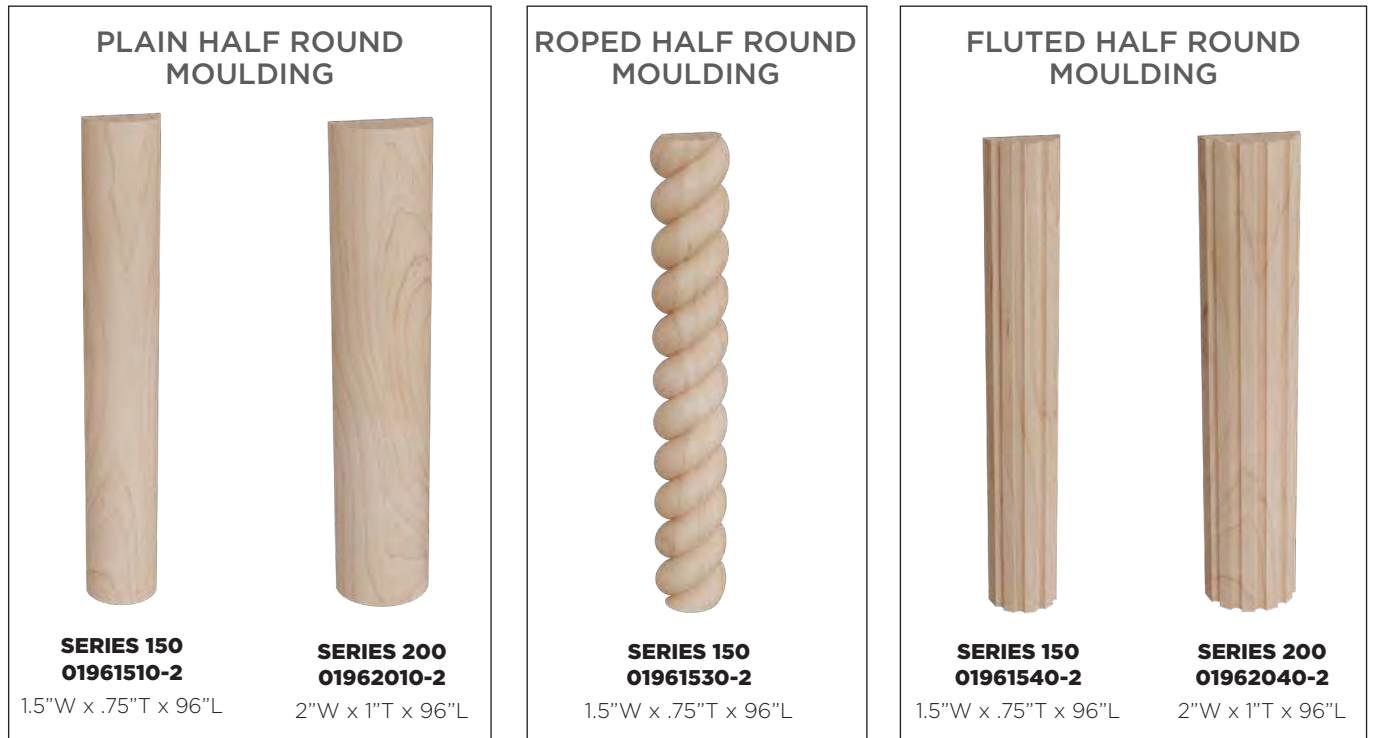

Series 150 are 1.5" Half Round Mouldings to fit spaces 2.5" or wider.  
Series 200 are 2" Half Round Mouldings to fit spaces 3" or wider.



# CREATE-A-COLUMN™ & HALF ROUND MOULDINGS

**150 COMBO SPINDLE**  
For use with 1.5" half round



**SERIES 150**  
**01391510-2**  
2"W x .906"D x 9.438"L

**CENTER SPINDLES**



For use with 1.5" half round

**SERIES 150**  
**01311510-2**  
2.125"W x 1"D x 3"L

For use with 2" half round

**SERIES 200**  
**01312010-2**  
2.875"W x 1.3"D x 3.5"L

**END BLOCKS**



For use with 1.5" spindle

**SERIES 150**  
**01331510-2**  
2.5"W x 1.19"D x 5.75"L

For use with 2" spindle

**SERIES 200**  
**01332010-2**  
3"W x 1.4"D x 5.75"L

**END SPINDLES**



For use with 1.5" half round

**SERIES 150**  
**01321510-2**  
2.5"W x 1"D x 3"L

For use with 2" half round

**SERIES 200**  
**01322010-2**  
3"W x 1.5"D x 3.5"L



# DECORATIVE MOULDINGS & PILASTERS

Image: Hardwood Shiplap Decorative Moulding

## DECORATIVE MOULDINGS

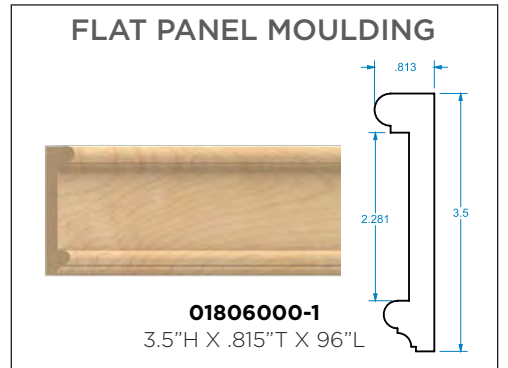
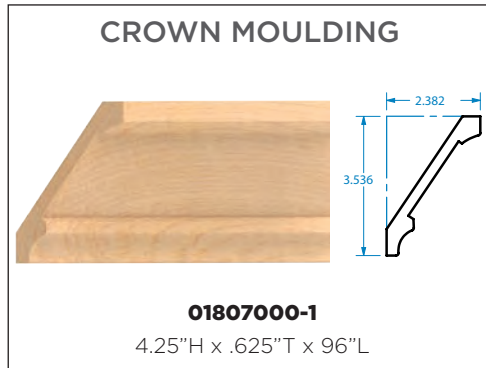
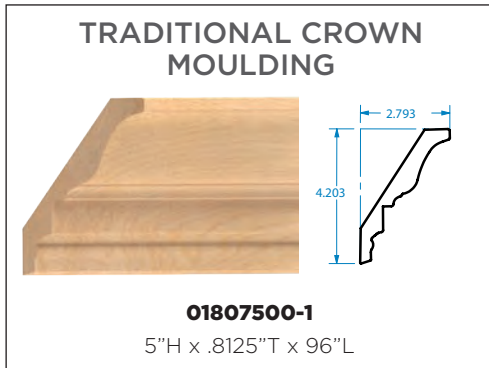
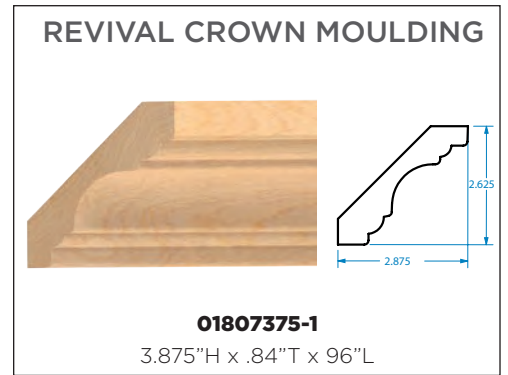

## LIGHT RAIL MOULDING

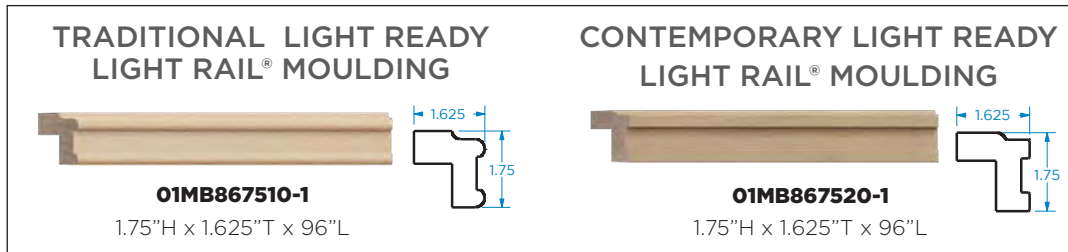

## PILASTERS

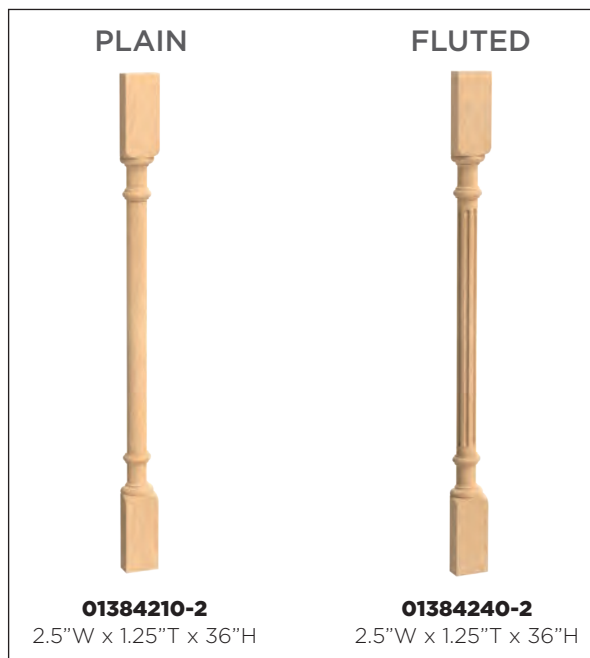

## MOULDINGS

**AK:**  
Red Oak

**AL:**  
Alder

**CH:**  
Cherry

**HM:**  
Hard Maple

# SHELVING

Image: Contemporary Floating Shelving



## FLOATING SHELVING

Our floating shelves include hidden shelf supports. Hidden shelf supports can be purchased separately for use in your custom projects.

### CONTEMPORARY FLOATING CORNER SHELF W/ HIDDEN STEEL SUPPORT



**01MFL102424-1**

10" D x 2.5" T x 24" Each Way

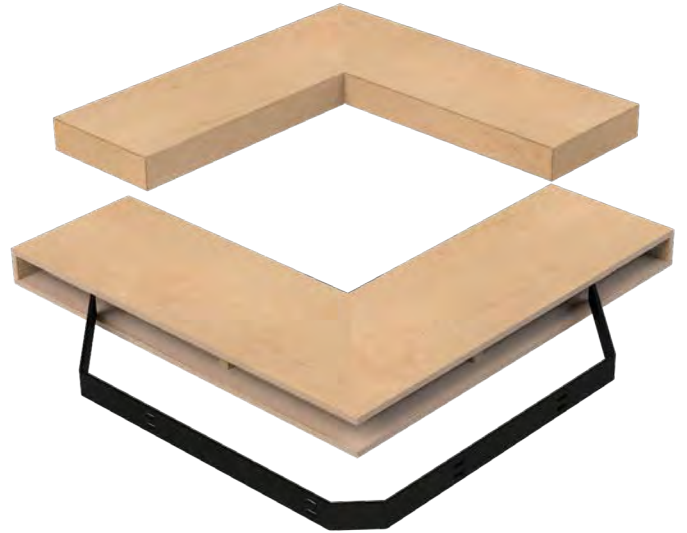

**01MFL103030-1**

10" D x 2.5" T x 30" Each Way

### CONTEMPORARY FLAT CORNER SHELF



**01MSH122424-1**

12" D x .75" T x 24" Each Way



**01MSH123030-1**

12" D x .75" T x 30" Each Way

### CONTEMPORARY FLOATING LINEAR SHELF W/ HIDDEN STEEL SUPPORT



**01MFL102410-1**

10" D x 2.5" T x 24" L



**01MFL103610-1**

10" D x 2.5" T x 36" L

Custom sizes available!

SHELVING

**AK:**  
Red Oak

**AL:**  
Alder

**CH:**  
Cherry

**HM:**  
Hard Maple

**HK:**  
Hickory

**PT:**  
Paint Grade

**WK:**  
White Oak

**WL:**  
Walnut

# BRACKETS, STRAPS, CHANNEL SHELVING



**SLIMLINE CHANNEL SHELF**

- 01CHSHLF0424-1**  
2.75" H x 24" W x 5.125" D
- 01CHSHLF0436-1**  
2.75" H x 36" W x 5.125" D
- 01CHSHLF0448-1**  
2.75" H x 48" W x 5.125" D
- 01CHSHLF0460-1**  
2.75" H x 60" W x 5.125" D

Includes leveler & walldog screws.

**SLIMLINE CHANNEL SHELF - ALUMINUM**



- 01CHSHLF0424-1**  
2.5" H x 24" W x 4.125" D
- 01CHSHLF0436-1**  
2.5" H x 36" W x 4.125" D
- 01CHSHLF0448-1**  
2.5" H x 48" W x 4.125" D

**DEEP SLIMLINE CHANNEL SHELF - ALUMINUM**



- 01CHSHLF0624-1**  
2.5" H x 24" W x 6.125" D
- 01CHSHLF0636-1**  
2.5" H x 36" W x 6.125" D
- 01CHSHLF0648-1**  
2.5" H x 48" W x 6.125" D

Includes leveler & walldog screws.

**TEXTURED FLOATING SHELF  
W/ HIDDEN STEEL SUPPORT**



- 01FL102410-1**  
10" D x 2.5" T x 24" W
- 01FL103610-1**  
10" D x 2.5" T x 36" W

**CORNER FLOATING SHELF -  
HAND SCRAPPED**



- 01FL103030-1**  
10" D x 2.5" T x 30" W

# FLOATING SHELF & SUPPORT BRACKETS

**HIDDEN CORNER SHELF SUPPORT**



**01981515WR1**  
21.718" W Each Way x 1.65" H  
For use with 24" x 24" corner shelf.

**01982222WR1**  
28.75" W Each Way x 1.75" H  
For use with 30" x 30" corner shelf.

**9" HIDDEN SHELF SUPPORT**



**01980109WR1**  
9.75" W x 8" D x 1.75" H  
For use with any 10"D X 2"T floating shelf.

**16" HIDDEN SHELF SUPPORT**



**01980116WR1**  
16" W x 8" D x 1.75" H  
For use with any floating shelf.

**22.5" HIDDEN SHELF SUPPORT**



**01981022WR1**  
22.25" W x 8" D x 1.75" H  
For use with any floating shelf.



# OUTLETS & VENTS

Image: Linear StyleToe Kick Vent

# OUTLET COVERS

SINGLE OUTLET	DOUBLE OUTLET
	
<b>01450002-1</b> 3.5"W x .375"T x 5.75"H	<b>01451002-1</b> 5.5"W x .375"T x 5.75"H

SINGLE ROCKER	DOUBLE ROCKER	TRIPLE ROCKER	QUAD ROCKER
			
<b>01450003-1</b> 3.5"W x .375"T x 5.75"H	<b>01451003-1</b> 5.5"W x .375"T x 5.75"H	<b>01453003-1</b> 7.313"W x .375"T x 5.75"H	<b>01454003-1</b> 9.125"W x .375"T x 5.75"H

SINGLE SWITCH	DOUBLE SWITCH	TRIPLE SWITCH	QUAD SWITCH
			
<b>01450001-1</b> 3.5"W x .375"T x 5.75"H	<b>01451001-1</b> 5.5"W x .375"T x 5.75"H	<b>01453001-1</b> 7.313"W x .375"T x 5.75"H	<b>01454001-1</b> 9.125"W x .375"T x 5.75"H

## FINISHING TOUCHES

AK: Red Oak

AL: Alder

CH: Cherry

HM: Hard Maple

WL: Walnut

WK: White Oak

## OUTLET COVERS

SWITCH COMBO 1



**01450012-1**

5.5"W x .375"T x 5.75"H

SWITCH COMBO 2



**01451012-1**

7.313"W x .375"T x 5.75"H

SWITCH COMBO 3



**01450013-1**

5.5"W x .375"T x 5.75"H

SWITCH COMBO 4



**01451013-1**

7.313"W x .375"T x 5.75"H

SINGLE BLANK  
SWITCH PLATE COVER



**01452001-1**

3.5"W x .375"T x 5.75"H

DOUBLE BLANK  
SWITCH PLATE COVER



**01452002-1**

5.5"W x .375"T x 5.75"H

### ELECTRICAL BOX ROUTING

Let your kitchen island design speak for itself with an integrated electrical outlet.

We offer Electrical Box Routing and Electrical Boring to most columns greater than 3"W. Electrical Box Routing allows you to install electrical components directly into the column. For additional electrical wiring, we can bore a ½" hole through the entire length of the column.

AVAILABLE FOR MOST COLUMNS.



# TOE KICK VENT

## GRATE STYLE TOE KICK VENT

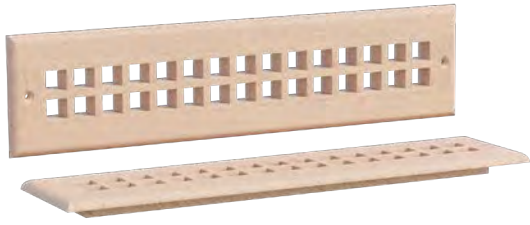

**01992114-1**  
15.75"W x .75"T x 3.75"H



**01992110-1**  
11.75"W x .75"T x 3.75"H



**01992124-1**  
25.75"W x .75"T x 3.75"H



**01992112-1**  
13.75"W x .75"T x 3.75"H

## LINEAR STYLE TOE KICK VENT

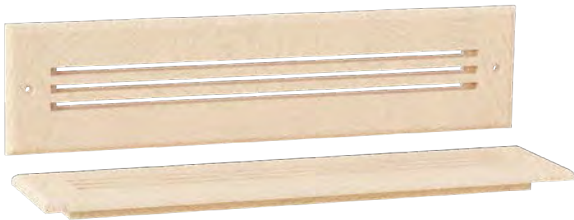

**01992214-1**  
15.75"W x .75"T x 3.75"H



**01992224-1**  
25.75"W x .75"T x 3.75"H

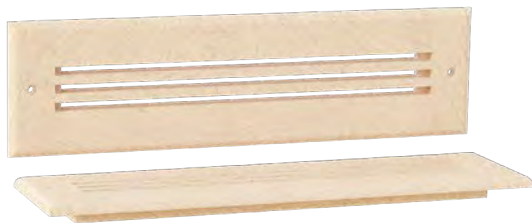

**01992210-1**  
11.75"W x .75"T x 3.75"H



**01992212-1**  
13.75"W x .75"T x 3.75"H

## FINISHING TOUCHES

AK: Red Oak

AL: Alder

CH: Cherry

HM: Hard Maple

WL: Walnut

WK: White Oak

# TOE KICK VENT

## SELF RIMMING TOE KICK VENT



**01992010-1**  
11.75"W x .75"T x 3.75"H



**01992012-1**  
13.75"W x .75"T x 3.75"H



**01992014-1**  
15.75"W x .75"T x 3.75"H



**01992024-1**  
25.75"W x .75"T x 3.75"H

## SELF RIMMING FLOOR VENT



**01994014-1**  
15.75"W x .75"T x 5.75"H



**01994010-1**  
11.75"W x .75"T x 5.75"H



**01994012-1**  
13.75"W x .75"T x 5.75"H



# CUSTOM PANEL INSERTS

Image: Custom Decorative Hardwood Panel

## NEW! CUSTOM DECORATIVE PANELS

### CHOOSE YOUR MATERIAL. CHOOSE YOUR STYLE. CHOOSE YOUR PLACEMENT.

Bring your designs to life with customizable panels crafted to fit your exact vision. Whether you're designing cabinetry, furniture, or architectural accents, our panels offer limitless creative options.



#### Material Options ( 2 Panel Minimum)

- **1/8" Brass Sheets:** Luxe metallic finish for a bold, modern look.
- **1/4" MDF:** Smooth and versatile, ready to paint or finish.
- **1/4" MDF with Hardwood Veneer:** Adds natural beauty and warmth.

#### Customization Choices

- **Style:** Select from a variety of decorative patterns.
- **Pattern Count:** Choose how many repeats per panel.
- **Placement:** Position your design at the top, center, or bottom of the panel.

#### Crafting Methods

- **CNC Routed:** Clean precision with a 1/16" minimum radius.
- **Laser Cut:** Tighter, more intricate designs with darkened interior edges that create a subtle shadow effect.

#### Why Choose Our Panels?

- Fully customizable for your project needs.
- Available in multiple premium materials.
- Options for clean precision or artistic detailing.
- Designed for cabinetry, furniture, and architectural features.

## NEW! CUSTOM METAL CABINET MULLIONS

Our Custom Mullion Program offers designers and architects unparalleled versatility for elegant custom designs. Using CNC and laser-cutting technology, each panel features customizable patterns for optimal ventilation, ideal for cabinetry, closets, mudrooms, and architectural wall accents.

SIMPLE



### Elevate Your Cabinetry with Style and Function

Our **custom metal mullions** bring sophistication and precision to cabinetry design. Perfect for high-end projects, these mullions combine elegance, functionality, and versatility.

### Material & Finish Options

- **Stainless Steel:** Sleek, modern, and durable
- **Brass:** Warm, luxurious appeal
- **Finishes:** Plain, powder-coated, or clear-coated
- **Design Flexibility:** Ideal for intricate patterns and high-end design aesthetics
- Perfect for cabinetry requiring ventilation
- Delicate designs can be sandwiched between glass for a refined, custom look

### Why Choose Our Metal Mullions?

- **Durable materials** suitable for long-lasting use
- Available in **multiple finishes** to match your design vision
- Perfect for creating **architectural detail** and **visual interest** in cabinetry
- Combines function with decorative appeal

STANDARD



COMPLEX



CUSTOM PANELS



Custom Laser-Cut Metal Mullions



# GALLERY RAIL

Image: Double Contemporary Gallery Rail in Chrome

# GALLERY RAIL

Install Gallery Rail components to the tops of cabinets, furniture, shelving, spice racks, and more to create a curated look. We recommend spacing between posts across the front to be 10" - 12" apart. Manufactured from the finest quality cast brass, Gallery Rail components will not tarnish, rust, peel, or chip. Gallery Rail Sample Kits are available.

## BRASS TRADITIONAL

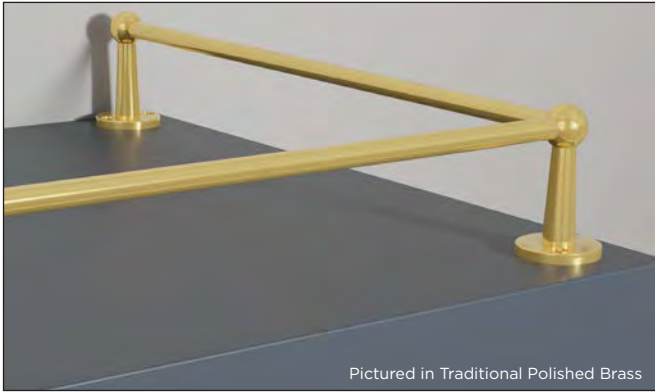

Pictured in Traditional Polished Brass

### POLISHED BRASS

**Corner Post:** 01HC9002PB1  
 .906" DIAM. x 1.575"H  
**Center Post:** 01HC9001PB1  
 .906" DIAM. x 1.575"H  
**End Post:** 01HC9003PB1  
 .906" DIAM. x 1.575"H  
**Rail:** 01HC900436PB1  
 6 mm DIAM. x 36"L



### CHROME

**Corner Post:** 01HC9002CR1  
 .906" DIAM. x 1.575"H  
**Center Post:** 01HC9001CR1  
 .906" DIAM. x 1.575"H  
**End Post:** 01HC9003CR1  
 .906" DIAM. x 1.575"H  
**Rail:** 01HC900436CR1  
 6 mm DIAM. x 36"L



### FLAT BLACK

**Corner Post:** 01HC9002WR1  
 .906" DIAM. x 1.575"H  
**Center Post:** 01HC9001WR1  
 .906" DIAM. x 1.575"H  
**End Post:** 01HC9003WR1  
 .906" DIAM. x 1.575"H  
**Rail:** 01HC900436WR1  
 6 mm DIAM. x 36"L



### SATIN BRASS

**Corner Post:** 01HC9002SB1  
 .906" DIAM. x 1.575"H  
**Center Post:** 01HC9001SB1  
 .906" DIAM. x 1.575"H  
**End Post:** 01HC9003SB1  
 .906" DIAM. x 1.575"H  
**Rail:** 01HC900436SB1  
 6 mm DIAM. x 36"L



Contemporary  
Gallery Rail

# BRASS GALLERY RAIL

## SINGLE CONTEMPORARY



Pictured in Stainless Steel



### STAINLESS STEEL

**End Post:** 01HC9014SS1  
.906" DIAM. x 1.575" H  
**Center Post:** 01HC9015SS1  
.906" DIAM. x 1.575" H  
**Corner Adapter:** 01HC9016SS1  
1.102" DIAM. X 1.654"H  
**Rail:** 01HC900436SS1, 6 mm Diam. x 36"L



## DOUBLE CONTEMPORARY



Pictured in Flat Black



### STAINLESS STEEL

**End Post:** 01HC9024SS1  
1.063" DIAM. x 1.693" H  
**Center Post:** 01HC9025SS1  
.906" DIAM. x 1.575" H  
**Corner Adapter:** 01HC9026SS1  
1.102" DIAM. X 1.654"H  
**Rail:** 01HC900436SS1, 6 mm Diam. x 36"L



### FLAT BLACK

**End Post:** 01HC9014WR1  
.906" DIAM. x 1.575" H  
**Center Post:** 01HC9015WR1  
.906" DIAM. x 1.575" H  
**Corner Adapter:** 01HC9016WR1  
1.102" DIAM. X 1.654"H  
**Rail:** 01HC900436WR1, 6 mm Diam. x 36"L



### FLAT BLACK

**End Post:** 01HC9024WR1  
1.063" DIAM. x 1.693" H  
**Center Post:** 01HC9025WR1  
.906" DIAM. x 1.575" H  
**Corner Adapter:** 01HC9026WR1  
1.102" DIAM. X 1.654"H  
**Rail:** 01HC900436WR1, 6 mm Diam. x 36"L



### SATIN BRASS

**End Post:** 01HC9014SB1  
.906" DIAM. x 1.575" H  
**Center Post:** 01HC9015SB1  
.906" DIAM. x 1.575" H  
**Corner Adapter:** 01HC9016SB1  
1.102" DIAM. X 1.654"H  
**Rail:** 01HC900436SB1, 6 mm Diam. x 36"L



### SATIN BRASS

**End Post:** 01HC9024SB1  
1.063" DIAM. x 1.693" H  
**Center Post:** 01HC9025SB1  
.906" DIAM. x 1.575" H  
**Corner Adapter:** 01HC9026SB1  
1.102" DIAM. X 1.654"H  
**Rail:** 01HC900436SB1, 6 mm Diam. x 36"L



### POLISHED BRASS

**End Post:** 01HC9014PB1  
.906" DIAM. x 1.575" H  
**Center Post:** 01HC9015PB1  
.906" DIAM. x 1.575" H  
**Corner Adapter:** 01HC9016PB1  
1.102" DIAM. X 1.654"H  
**Rail:** 01HC900436PB1, 6 mm Diam. x 36"L



### POLISHED BRASS

**End Post:** 01HC9024PB1  
1.063" DIAM. x 1.693" H  
**Center Post:** 01HC9025PB1  
.906" DIAM. x 1.575" H  
**Corner Adapter:** 01HC9026PB1  
1.102" DIAM. X 1.654"H  
**Rail:** 01HC900436PB1, 6 mm Diam. x 36"L



### CHROME

**End Post:** 01HC9014CR1  
.906" DIAM. x 1.575" H  
**Center Post:** 01HC9015CR1  
.906" DIAM. x 1.575" H  
**Corner Adapter:** 01HC9016CR1  
1.102" DIAM. X 1.654"H  
**Rail:** 01HC900436CR1, 6 mm Diam. x 36"L



### CHROME

**End Post:** 01HC9024CR1  
1.063" DIAM. x 1.693" H  
**Center Post:** 01HC9025CR1  
.906" DIAM. x 1.575" H  
**Corner Adapter:** 01HC9026CR1  
1.102" DIAM. X 1.654"H  
**Rail:** 01HC900436CR1, 6 mm Diam. x 36"L



## GALLERY RAIL

CR  
Chrome

PB:  
Polished Brass

SB:  
Satin Brass

SS:  
Stainless Steel

WR:  
Flat Black



# DECORATIVE BRASS HARDWARE

Image: Knurled Brass Footrail

# NEW! DESIGNER CANTILEVER BISTRO SHELVING

Available in Knurled, Reeded and Plain styles. Comes in Lacquered Polished Brass and Satin Brass finishes.

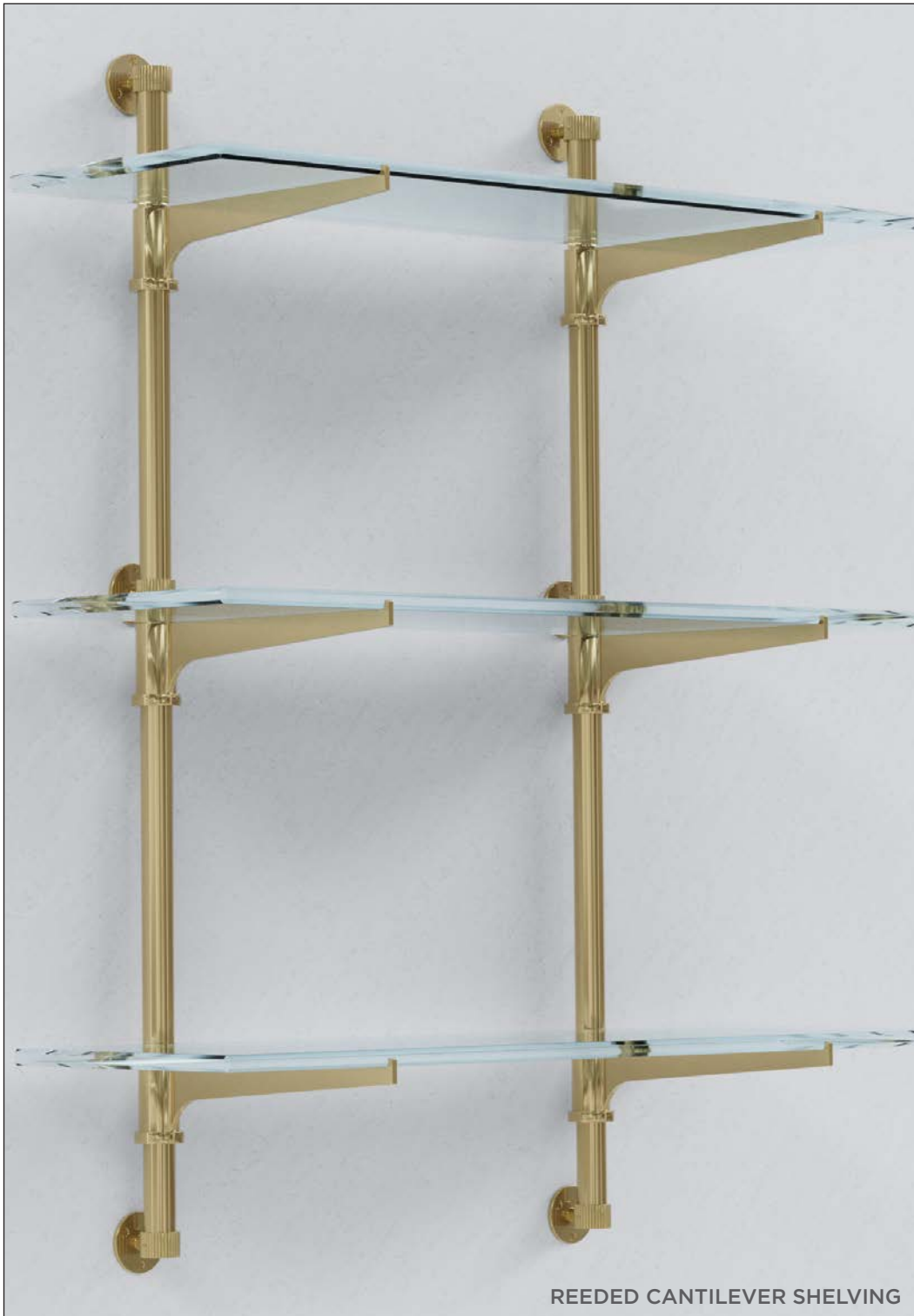

REEDED CANTILEVER SHELVING

DESIGNED FOR USE WITH 10" DEEP SHELVES ONLY  
GLASS SHELVES NOT INCLUDED



KNURLED

3 SHELF  
**01KCANT1036-1**  
36" high, 13" deep

4 SHELF  
**01KCANT1048-1**  
48" high, 13" deep



REEDED

3 SHELF  
**01RCANT1036-1**  
36" high, 13" deep

4 SHELF  
**01RCANT1048-1**  
48" high, 13" deep



PLAIN

3 SHELF  
**01CANT1036-1**  
36" high, 13" deep

4 SHELF  
**01CANT1048-1**  
48" high, 13" deep

Custom finishes & sizes available.

BRASS HARDWARE

**PB:**  
Polished Brass

**SB:**  
Satin Brass

## BRASS BISTRO SHELVING

Elevate your designs with the sophistication of Brass Bistro Shelving. Traditional, Contemporary and Cantilever Bistro Shelving Kits are stocked in Lacquered Polished Brass & Lacquered Satin Brass, with (5) custom finishes available\*. Custom finishes include Antique Copper, Antique Brass, Flat Black, Satin Nickel, and Polished Nickel. Our Brass Bistro Shelving is easy to assemble with set screws and includes installation hardware and assembly instructions.

*Glass shelves not included. All Brass tubes are 1" Diameter. \*Premium pricing applies for custom finishes.*

### FLUSH



#### FOR 10" SHELVES:

**3 SHELF**  
**01FLUSH1036-1**  
42" high,  
12.875" deep

**4 SHELF**  
**01FLUSH1048-1**  
56.5" high,  
12.875" deep

#### FOR 12" SHELVES:

**3 SHELF**  
**01FLUSH1236-1**  
42" high,  
14.875" deep

**4 SHELF**  
**01FLUSH1248-1**  
56.5" high,  
14.875" deep

### TRADITIONAL



#### FOR 10" SHELVES:

**3 SHELF**  
**01TRAD1036-1**  
42.25" high,  
13.375" deep

**4 SHELF**  
**01TRAD1048-1**  
56.375" high,  
13.375" deep

#### FOR 12" SHELVES:

**3 SHELF**  
**01TRAD1236-1**  
42.25" high,  
15.375" deep

**4 SHELF**  
**01TRAD1248-1**  
56.375" high,  
15.375" deep

We offer **Built-to-Order Bistro Shelving** in multiple configurations and finishes. Wall-to-floor, ceiling-to-countertop, and wall-to-countertop, you decide your connection points\*, number of shelves and more by designing your own Built-to-Order Bistro Shelving. For Traditional and Contemporary Bistro Shelving styles, you can define the depth of your shelves (Cantilever arms have a fixed depth for use with 10" deep shelves).

\*We do not offer ceiling-to-ceiling connection points.

\*\*Unlacquered brass (due to its raw nature) will oxidize, causing a patina film to form, giving the brass a greenish look.

PLEASE NOTE: Premium pricing applies for custom finishes.

#### STOCK FINISHES

**PB:**  
Polished Brass

**SB:**  
Satin Brass

\*\*Unlacquered  
Brass

Antique Brass

Flat Black

Antique  
Copper

Polished  
Nickel

Satin Nickel

## NEW! BRASS POT RAIL KITS

Available in Knurled and Plain styles. Comes in Lacquered Polished and Satin Brass and Flat Black finishes. Each kit includes all necessary rail components, assembly/installation hardware and six matching s-hooks. Heavy duty brass hooks available separately (QHOOK-1).

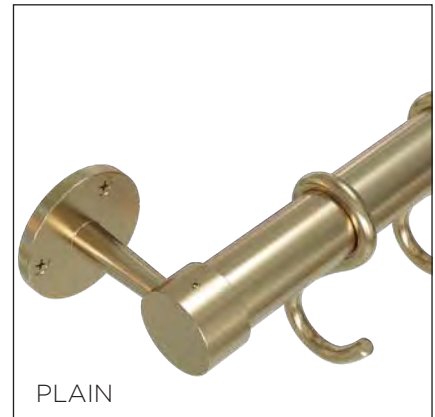

**BRASS HOOK**  
Pairs great with our Pot Rail Kit.



**QHOOK-1**  
Fits 1" diam. rod  
MUST BE PURCHASED SEPARATELY

**01POTRL-1-18** 1" Diam. Pot Rail Kit - 18" L  
**01KPOTRL-1-18** Knurled Design, 1" Diam. Pot Rail Kit - 18" L  
**01RPOTRL-1-18** Reeded Design, 1" Diam. Pot Rail Kit - 18" L

**01POTRL-1-24** 1" Diam. Pot Rail Kit - 24" L  
**01KPOTRL-1-24** Knurled Design, 1" Diam. Pot Rail Kit - 24" L  
**01RPOTRL-1-24** Reeded Design, 1" Diam. Pot Rail Kit - 24" L

**01POTRL-1-30** 1" Diam. Pot Rail Kit - 30" L  
**01KPOTRL-1-30** Knurled Design, 1" Diam. Pot Rail Kit - 30" L  
**01RPOTRL-1-30** Reeded Design, 1" Diam. Pot Rail Kit - 30" L

**01POTRL-1-36** 1" Diam. Pot Rail Kit - 36" L  
**01KPOTRL-1-36** Knurled Design, 1" Diam. Pot Rail Kit - 36" L  
**01RPOTRL-1-36** Reeded Design, 1" Diam. Pot Rail Kit - 36" L

3 styles, custom finishes & sizes available.

BRASS HARDWARE

**PB:**  
Polished Brass

**SB:**  
Satin Brass

**WR:**  
Flat Black

## NEW! BRASS CONTEMPORARY FOOT RAIL KITS

Add luxury and detail to home bars and kitchens with **Knurled Brass Foot Rail Kits** — crafted from **solid cast brass** with a **knurled** or **reeded texture**. Designed for residential scale with **1.5" diameter components**, kits are available in 4-ft, 5-ft, and 8-ft lengths. **Modular components** available, allowing for custom configurations and one-of-a-kind installations.

### REEDED FOOT RAIL KITS



#### 4' REEDED KIT INCLUDES:

- (1) 48" Pole
- (2) Floor Posts
- (2) End Caps
- (1) Center Post

**01RFOTRL1PB1-48**

#### 5' REEDED KIT INCLUDES:

- (1) 60" Pole
- (2) Floor Posts
- (2) End Caps
- (2) Center Posts

**01RFOTRL1PB1-60**

#### 8' REEDED KIT INCLUDES:

- (2) 48" Poles
- (2) Floor Posts
- (2) End Caps
- (3) Center Posts

**01RFOTRL1PB1-96**

#### CORNER CONNECTOR ADD-ON



**01474150-1**

1.389" x 3.425" x 3.425"

### KNURLED FOOT RAIL KITS



#### 4' KNURLED KIT INCLUDES:

- (1) 48" Pole
- (2) Floor Posts
- (2) End Caps
- (1) Center Post

**01KFOTRL1PB1-48**

#### 5' KNURLED KIT INCLUDES:

- (1) 60" Pole
- (2) Floor Posts
- (2) End Caps
- (2) Center Posts

**01KFOTRL1PB1-60**

#### 8' KNURLED KIT INCLUDES:

- (2) 48" Poles
- (2) Floor Posts
- (2) End Caps
- (3) Center Posts

**01KFOTRL1PB1-96**

#### CORNER CONNECTOR ADD-ON



**01474150-1**

1.389" x 3.425" x 3.425"

## WARRANTY INFORMATION

### Coverage

Products will be free from defects in materials and workmanship under normal household use.

### Not Covered

- Neglect, misuse, accidents, alterations, extreme conditions
- Exposure to water, humidity, or outdoor use
- Post-sale finishing
- Faulty installation or utilization
- Natural aging, wear, fading, color variations
- Improper cleaning or storage

## COMPONENT-SPECIFIC NOTES

### Unfinished Wood

- Seal ends promptly
- Cracking from improper storage not covered
- Clean only with dry cloth or compressed air

### Pre-Finished Wood

- Finish fading is natural and not covered
- Avoid ammonia, alcohol, or abrasive cleaners

### Brass Components

- **Unlacquered:** Patina and oxidation expected (not covered)
- **Lacquered:** Clean gently to preserve finish

### Electroplated Products

Color variation may occur between runs. Seamless match not guaranteed.

### Anodized Aluminum

- Resistant to rust, but must be dried after cleaning
- Extended exposure to moisture voids warranty

### UHB Tape & Designer DripEdge™

- Apply to clean surfaces with pressure
- Do not use in unsupported vertical applications

### Gallery Rail

For display use only. Not structurally rated.

### Samples & Sample Kits

For viewing only. Size/appearance may differ from final product.

### Sustainable Materials

Rattan, resin, leather, mesh are prone to aging. Natural wear not covered.

### Assembly/Installation

- Must be installed by responsible and experienced individuals
- Improper use or alteration voids warranty

### All Sales Are Final

- Products from this catalog are outsourced and distributed by WalzCraft.
- Due to short wait times, some orders may enter production the same day they are received.
- Orders may only be canceled or changed if the request is received and confirmed prior to WalzCraft ordering the material.
- Approved changes may result in additional charges.
- Changing an order may extend wait times.
- Cut-to-Size items are not eligible for cancellation, return or refund.

# SAFETY INFORMATION

## SAFETY & PROPOSITION 65 INFORMATION

### Safety & Handling Notice

At **Designs of Distinction™ by Brown Wood, Inc.®**, we are committed to delivering high-quality components and materials. Our products are designed to meet reasonable safety standards when handled with care and proper preparation.

Whether you're assembling, installing, or finishing an item, always follow included instructions and use basic safety practices. Personal protective equipment (PPE)—such as gloves, goggles, dust masks, and hearing protection—should be used when cutting, drilling, sanding, or applying finishes.

Improper handling or failure to follow instructions may result in injury or product damage.

### Wood Products

Most of our hardwood products (e.g., columns, corbels, mouldings, legs, tambour) are sold unfinished. These may include splinters or loose fibers. Activities like sanding, cutting, or finishing generate dust and debris—use PPE and proper ventilation.

**Finished wood** with clear-coat or other finishes should be treated the same, with added care during sanding or thinning, as finishes may release chemical particles. Avoid inhalation or ingestion.

- Wood Dust - OSHA
- Sanding Safety - Purdue University
- Splinter Removal - Popular Woodworking
- Eye Safety - Mayo Clinic

**California Proposition 65 Warning:** Drilling, sawing, sanding, or machining wood products can expose you to wood dust, a substance known to the State of California to cause cancer. Use PPE and avoid inhaling dust. Learn more at [www.P65Warnings.ca.gov/wood](http://www.P65Warnings.ca.gov/wood).

### Metal Products

Our metal items—such as shelving, trim, feet, rails, and grilles—are made from brass, aluminum, or steel:

- **Brass** may contain fine dust or shavings and can be sharp when cut.
- **Aluminum** (sometimes anodized or coated) may release debris when worked.
- **Steel** grilles and mesh may buckle or create sharp fragments during handling or cutting.

Always use PPE and make sure you're familiar with your tools and procedures.

- Metal Cutting Safety - <https://www.metals4u.co.uk/blog/how-to-cut-metal-a-focus-on-safety>
- Powder Coating Safety - <https://www.tcipowder.com/resources/safety-compliance>
- Treating Metal Wounds - <https://www.mayoclinic.org/first-aid/first-aid-cuts/basics/art-20056711>

## Other Materials

- **Rattan** is natural but may have surface residue—clean before use.
- **Resin** can release airborne particles when cut—use a dust mask and goggles.
- **Leather** may shed when trimmed—handle with care.
- **Glue & Tape** may contain chemicals—follow included directions and dispose of properly.

Use all products in a ventilated area and wear PPE suited to the task.

Safe Handling of Adhesives -

<https://www.adhesivesmag.com/articles/86751-safety-first-safe-handling-of-adhesives-and-sealants>

## Recommended PPE (via Zoro Tools)

These are general-use items and do not guarantee safety:

- Work Gloves
- Safety Goggles
- Dust Masks / Respirators
- Aprons, Ear Protection, First Aid Kits & More

## Final Reminder

Review all instructions before beginning any project, and only use tools and materials you are comfortable and familiar with. Your safety starts with preparation—use all products responsibly.

## PART NUMBER INDEX

### MATERIALS: TAMBOUR/ REEDED PANELS

011248100-1	2
011296100-1	2
012448100-1	2
011248101-1	2
011296101-1	2
011248102-1	2
011296102-1	2
012448102-1	2
011248103-1	2
011296103-1	2
011248104-1	2
011296104-1	2
011248105-1	2
011296105-1	2
011248106-1	2
011296106-1	2
011248107-1	2
011296107-1	2
012448107-1	2
011248110-1	2
011296110-1	2
012448110-1	2
011248302-1	3
011296302-1	3
012448302-1	3
011248304-1	3
011296304-1	3
012448304-1	3
011248402-1	3
011296402-1	3
012448402-1	3
011248403-1	3
011296403-1	3
012448403-1	3
011248201-1	4
011296201-1	4
011248202-1	4
011296202-1	4
011248203-1	4
011296203-1	4
012448203-1	4
011248204-1	4
011296204-1	4
011248206-1	4
011296206-1	4
011248207-1	4
011296207-1	4
012446100-1	5
012446102-1	5

012446107-1	5
012446110-1	5
012446127-1	5
012446302-1	5
012446304-1	5
012446402-1	5
012446403-1	5
014848127-1	6
019648127-1	6

### MATERIALS: METAL ACCENT TRIM

010451-1-1181	8
01110451-1-12	8
01110451-1-14	8
010451-1-1481	8
01110451-1-15	8
01110451-1-17	8
010451-1-1781	8
010451-1-1875	8
010451-1-2050	8
010451-1-2081	8
010451-1-2175	8
010451-1-2350	8
010451-1-2384	8
01TP1875-54	8
01TP1875-8	8
01TP50-108	8
01TP50-8	8
01PEN-1	8
01110788-1	9
01110810-1	9
01200250-1	9
01110030-1	9
01110451-1	9
01-RAP7572-1	10
01110171-1	10
01HC1005-1	11
01HC1010-1	11
01HC1008-1	11
01990810-1	11
01HC1007-1	11

### MATERIALS: CUT-TO-SIZE

012248MESH-1	13
014448MESH-1	13
013624M22-1	14
013648M22-1	14
011848M22-1	14
011848332P-1	14
012472332P-1	14

013624332P-1	14
013648332P-1	14
011848CG10-1	14
012472CG10-1	14
013624CG10-1	14
013648CG10-1	14
011848286S-1	14
012472286S-1	14
013624286S-1	14
013648286S-1	14
011848DK08-1	14
012472DK08-1	14
013624DK08-1	14
013648DK08-1	14
01184811614P-1	14
01247211614P-1	14
01362411614P-1	14
01364811614P-1	14
0118481214F-1	14
0124721214F-1	14
0136241214F-1	14
0136481214F-1	14
0118481220T-1	14
0136241220T-1	14
0136481220T-1	14
011848R332P-1	14
013624R332P-1	14
013648R332P-1	14
011848R614P-1	14
013624R614P-1	14
013648R614P-1	14
011848315C-1	14
012472315C-1	14
013624315C-1	14
013648315C-1	14
013624226-1	14
013648226-1	14
011848226-1	14
01SQ2472214F-1	15
01SQ3624214F-1	15
01SQ3648214F-1	15
01SQ1848214F-1	15
01SQ2472286S-1	15
01SQ3624286S-1	15
01SQ3648286S-1	15
01SQ1848286S-1	15
01SQ1848DK08-1	15
01SQ2472DK08-1	15
01SQ3624DK08-1	15
01SQ3648DK08-1	15
01SQ2472332P-1	15

01SQ3624332P-1	15
01SQ3648332P-1	15
01SQ1848332P-1	15
011848RE25-1	15
012472RE25-1	15
013624RE25-1	15
013648RE25-1	15
01DGRETAINDER	15
01103	16
01110	16
01107	16
01112	16
0124481802	16
0148481802	16
0124481803	16
0148481803	16
0124481804	16
0148481804	16
013202	17
013201	17
011202NT1	17
011203NT1	17
011204NT1	17
011201NT1	17
013216WR1	17
015618WR1	17
012652-1	17
0124481652-1	17
0148481652-1	17
0124482216-1	17
0148482216-1	17

### POSTS & TABLE LEGS

01243029-1	20
01243024-6	20
01243018-6	20
01245129-1	20
01245124-1	20
01245118-1	20
01612010-1	21
01612010-3	21
01722910-1	21
01724529-1	21
01621025-1	21
01621025-3	21
01613010-1	21
01613025-1	21
01723001-1	22

01734529-1	22	01590224-1	27	01634010-1	32	01TRIKIT403-1	39
01724001-1	22	01590227-1	27	01735010-1	32	01EPS3025-1	40
01614010-1	22	01590223-1	27	01635010-1	32	01EPS3036-1	40
01614025-1	22	01590225-1	27	01636010-1	32	01EPT1525-1	40
01040127-1	22	01590228-1	27	01530310-1	33	01EPT1536-1	40
01040160-1	22	01520223-1	28	01540310-1	33	01EPT3025-1	40
01220160-1	22	01040270-1	28	01000310-1	33	01EPT3036-1	40
01110110-1	22	01040275-1	28	01160310-1	33	01EPAR1525-1	40
01060160-1	22	01110210-1	28	01240310-1	33		
01060110-1	23	01042760-1	28				
01510110-1	23	01040260-1	28	<b>END PANELS</b>		<b>FURNITURE &amp; BUN FEET</b>	
01590122-1	23	01220260-1	28	01XPN3025LNG-1	35	01708310-1	42
01590124-1	23	01250210-1	28	01XPN3036LNG-1	35	01708010-1	42
01590127-1	23	01510228-1	28	01XPN1525LNG-1	35	01708110-1	42
01000110-1	23	01515028-1	28	01XPN1536LNG-1	35	01703110-1	42
01210110-1	23	01060260-1	29	01XPNL3025-1	35	01703010-1	42
01ANGLEPLATE	23	01060220-1	29	01XPNL3036-1	35	01703210-1	42
01STRAIGHTPLATE	23	01510210-1	29	01XPNL1525-1	35	01707410-1	43
01HDPLATE	23	01060210-1	29	01XPNL1536-1	35	01707440-1	43
01724500-1	24	01160210-1	29	01XPN3025LNG-4	36	01709010-1	43
01722010-1	24	01150220-1	29	01XPN3036LNG-4	36	01707710-1	43
01622010-3	24	01560210-1	29	01XPN1525LNG-4	36	01700457-1	44
01622025-3	24	01520210-1	29	01XPN1536LNG-4	36	01705710-1	44
01622025-1	24	01570217-1	30	01XPNL3025-4	36	01706065-1	44
01622010-1	24	01580217-1	30	01XPNL3036-4	36	01705080-1	44
01623010-1	24	01082710-1	30	01XPNL1525-4	36	01750460-1	44
01623025-1	24	01080210-1	30	01XPNL1536-4	36	01704060-1	44
01723010-1	24	01230210-1	30	01XBS34241	37	01700146-1	44
01734510-1	24	01080270-1	30	01XBS34361	37	01703510-1	44
01530210-1	25	01082740-1	30	01290180-1	37	01700627-1	44
01540210-1	25	01080240-1	30	01290280-1	37	01705860-1	44
01624010-1	25	01230240-1	30	01RADTBS2534-1	38	01705715-1	44
01624025-1	25	01082730-1	30	01RADTBS3634-1	38	01705175-1	45
01724010-1	25	01080230-1	30	01RADBS2534-1	38	01705610-1	45
01725010-1	25	01230230-1	30	01RADBS3634-1	38	01705112-1	45
01625010-1	25	01140210-1	30	01RECBASE-1	39	01705510-1	45
01606010-1	25	01625046-1	31	01RNDBASE345-1	39	01705810-1	45
01626010-1	25	01510204-1	31	01TRIBASE-1	39	01705225-1	45
01180210-1	26	01240210-1	31	01RECKIT100-1	39	01731010-1	45
01510202-1	26	01090215-1	31	01RECKIT302-1	39	01700310-1	45
01040240-1	26	01100211-1	31	01RECKIT304-1	39	01705110-1	45
01040210-1	26	01386050-1	31	01RECKIT402-1	39	01704075-1	45
01010285-1	26	01626050-1	31	01RECKIT403-1	39	01700210-1	45
01010280-1	26	01110218-1	31	01RNDKIT104-1	39	01706060-1	46
01020280-1	26	01100218-1	31	01RNDKIT106-1	39	01700018-1	46
01000210-1	27	01250310-1	32	01RNDKIT203-1	39	01705155-1	46
01210210-1	27	01510328-1	32	01RNDKIT206-1	39	01705150-1	46
01030210-1	27	01632010-1	32	01TRIKIT100-1	39	01700245-1	46
01470210-1	27	01633010-1	32	01TRIKIT302-1	39	01700245-6	46
01410210-1	27	01733010-1	32	01TRIKIT304-1	39	01700345-1	46
01590222-1	27	01734010-1	32	01TRIKIT402-1	39	01700345-6	46

01705310-1	47			01601300-1	55	<b>CREATE-A-COLUMN™/HALF ROUND MOULDINGS &amp; CORNER MOULDINGS</b>	01RADCRN297-1	63
01760410-1	47	01244006-1	48	01601100-1	55		01RADCRN397-1	63
01704210-1	47	01244009-6	48	01607004-1	55		01RADCRN697-1	63
01706010-1	47			01607001-1	55		01962010-2	64
01702510-1	47	01244009-1	48	01607005-1	55		01961510-2	64
01700015-1	47	01700400-1	49	01607117-1	56		01961530-2	64
01704110-1	47	01700402-1	49	01607217-1	56		01961540-2	64
01704010-1	47	01700012-1	49	01607317-1	56		01962040-2	64
01704040-1	47	01700905-1	49	01604510-1	56		01961520-2	64
01704910-1	47	01700408-1	49	01604505-1	56		01962020-2	64
01240006-6	48	01700406-1	49	01606002-1	56		01391510-2	65
		01700412-1	49	01606001-1	56		01311510-2	65
01240006-1	48	01700410-1	49	01606003-1	56		01312010-2	65
01240009-6	48	01700401-1	49	01608009-1	57	01331510-2	65	
		01704017-1	49	01608007-1	57	01332010-2	65	
01240009-1	48	01706018-1	49	01608010-1	57	01321510-2	65	
01241006-6	48	01FRS1010-1	50	01608008-1	57	01322010-2	65	
		01FRS1254-1	50	01608001-1	57			
01241006-1	48	01FRC1010-1	50	01601205-1	57			
01241009-6	48	01FRC1040-1	50	01601204-1	57			
		01SLV245-1	50	01601203-1	57			
01241009-1	48	01SLV345-1	50	01607010-1	58	<b>DECORATIVE MOULDING &amp; PILASTERS</b>	01SHIPLAP-1	67
01242006-1	48	01SLV2-1	50	01607011-1	58		01827578-1	67
01242006-6	48	01SLV3-1	50	01607316-1	58		01807375-1	67
		01SLV4-1	50	01607216-1	58		01807500-1	67
01242009-1	48	01SLV5-1	50	01901005-1	58		01807000-1	67
01242009-6	48	01SLPR106-1	50	01901003-1	58		01806000-1	67
		01SLPR105-1	50	01607315-1	58		01MB867510-1	67
01221006-6	48	01SLPR104-1	50	01607215-1	58		01MB867520-1	67
				01901105-1	59		01384210-2	67
01221009-6	48	<b>BRACKETS &amp; CORBELS</b>		01901001-1	59		01384240-2	67
		01ARCHKNLD1-1	52	01901002-1	59		01386050-1	67
01222006-6	48	01ARCHPLN1-1	52	01901108-1	59			
		01600016-1	52	01901107-1	59			
01223006-6	48	01600006-1	52	01901009-1	59			
		01651270-1	52	01600928-1	59	<b>SHELVING</b>		
01223009-6	48	01605006-1	53	01600628-1	59	01MFL103030-1	69	
		01605007-1	53	01601427-1	60	01MFL102424-1	69	
01245106-6	48	01605008-1	53	01600927-1	60	01MSH123030-1	69	
		01605009-1	53	01600627-1	60	01MSH122424-1	69	
01245106-1	48	01600300-1	53	01600318-1	60	01MFL102410-1	69	
01245109-6	48	01607012-1	53	01904991-1	60	01MFL103610-1	69	
01245109-8	48	01600001-1	54	01904990-1	60	01FL102410-1	70	
01245109-1	48	01600002-1	54	01901004-1	60	01FL103610-1	70	
01243006-1	48	01600003-1	54	01904993-1	60	01CHSHLF0424-1	70	
01243006-6	48	01600009-1	54	01605001-1	61	01CHSHLF0436-1	70	
01243006-8	48	01607009-1	54	01605000-1	61	01CHSHLF0448-1	70	
01243009-6	48	01607008-1	54	01605005-1	61	01CHSHLF0460-1	70	
		01607006-1	54			01CHSHLF0624-1	70	
01243009-1	48	01607007-1	54			01CHSHLF0636-1	70	
01244006-6	48	01601400-1	55			01CHSHLF0648-1	70	

01981515WR1	71
01982222WR1	71
01980109WR1	71
01981022WR1	71
01980116WR1	71

**OUTLETS & VENTS**

01450002-1	73
01451002-1	73
01450003-1	73
01451003-1	73
01453003-1	73
01454003-1	73
01450001-1	73
01451001-1	73
01453001-1	73
01454001-1	73
01450012-1	74
01451012-1	74
01450013-1	74
01451013-1	74
01452001-1	74
01452002-1	74
01992114-1	75
01992110-1	75
01992124-1	75
01992112-1	75
01992214-1	75
01992224-1	75
01992210-1	75
01992212-1	75
01992010-1	76
01992012-1	76
01992014-1	76
01992024-1	76
01994014-1	76
01994012-1	76
01994010-1	76

**DECORATIVE BRASS**

**HARDWARE**

01KCANT1036-1	85
01KCANT1048-1	85
01RCANT1036-1	85
01RCANT1048-1	85
01CANT1036-1	85
01CANT1048-1	85
01FLUSH1036-1	86
01FLUSH1048-1	86
01FLUSH1236-1	86
01FLUSH12361	86
01FLUSH1248-1	86
01FLUSH12481	86
01TRAD1036-1	86
01TRAD1048-1	86
01TRAD1236-1	86
01TRAD1248-1	86
01POTRL1-1-18	87
01POTRL1-1-24	87
01POTRL1-1-30	87
01POTRL1-1-36	87
01KPOTRL1-1-18	87
01KPOTRL1-1-24	87
01KPOTRL1-1-30	87
01KPOTRL1-1-36	87
01RPOTRL1-1-18	87
01RPOTRL1-1-24	87
01RPOTRL1-1-30	87
01RPOTRL1-1-36	87
01QHOOK-1	87
01RFOTRL1-1-48	88
01RFOTRL1-1-60	88
01RFOTRL1-1-96	88
01KFOTRL1-1-48	88
01KFOTRL1-1-60	88
01KFOTRL1-1-96	88
01474150-1	88

**GALLERY RAIL**

01HC9001-1	82
01HC9002-1	82
01HC9003-1	82
01HC900436-1	82
01HC9014-1	83
01HC9015-1	83
01HC9016-1	83
01HC9024-1	83
01HC9025-1	83
01HC9026-1	83



# WARNING!



Designs of Distinction<sup>®</sup>'s "rigid" (formerly solid) style beaded insert panels have been manufactured to be used as center panel inserts for frames only. Due to the machined profile of the panel and the material's thinness, this product is not recommended for use without being captured within a frame.

If installed as a center panel insert into a frame, you should allow for movement of the panel within the frame - to account for the natural expansion and contraction of the material. When finishing, the product should be finished on both sides and allowed to air dry. **DO NOT OVEN DRY.**

Should you choose to use our rigid panels as a stand-alone item, you can minimize movement by attaching the panel to a 1/4" - 3/8" backer. However, this does NOT guarantee completely stable product and will not be warranted by Designs of Distinction.

For onlay applications - such as walls, hoods or cabinet wraps - we recommend our flexible panel products. Flexible beaded panels consist of individual staves, glued to a flexible canvas or paper backer. Because they are individual staves, they move independently of each other and do not cause stress across the panel.

**Please note:** Panels that are exposed to extreme variations in humidity, i.e.: fireplace surround, oven hood, or in a bathroom will have greater expansion and contraction regardless of the finish applied or method of construction.

Designs of Distinction's warranty covers products installed and finished per the recommendations above for 1 year after purchase. It is recommended that products exposed to humidity changes be resealed periodically to reduce the loss of moisture.

**Cut-to-Size Decorative Grille & Mesh Kit**



- **SKU: 01DGMESHSAMPLE**
- Decorative Grille & Mesh samples enclosed in 5" x 5" envelopes, clearly labeled with style and finish.
- Includes (1) of each electroplated hand-woven Decorative Grille & Mesh we carry.
- Italian Mesh, Rattan, Resin, and Leather Kits can be added.
- Finishes vary.

**Cut-to-Size Materials Showroom Display**



- **SKU: 01CTSFRAME-25**
- 31.5"H x 31.5"W
- White frame including 24 cut-to-size materials of your choice.
- Finishes vary.
- Hanging hardware included.

**Cut-to-Size Decorative Grille & Mesh Countertop Display**

- **SKU: 01GRILLECOUNTER**
- (100) Cut-to-Size Brochures
- (1) Countertop Display Tray
- Decorative Grille & Mesh samples enclosed in 5" x 5" envelopes, clearly labeled with style and finish.
- Includes (1) of each electroplated hand-woven Decorative Grille & Mesh, Italian Mesh, and Fine Wire Mesh styles we carry.
- Finishes vary.



## Leather Sample Kit (01LEATHERSMPL)



4" x 4" Squares  
Includes samples of all leather styles & colors.

## Resin Sample Kit (01RESINSMPL)



4" x 4" Squares  
Includes samples of all resin styles & colors.

## Italian Mesh Sample Kit (01ITALSMPL)



4" x 4" Squares. Includes all styles of our Italian Mesh.

## Rattan Sample Kit (01RATTANSMPL)



4" x 4" Squares  
Includes samples of all rattan styles & colors.

# Your Guide to Sample Kits with Designs of Distinction®

All Metallic Trim Kits include 12" sample pieces in each finish we offer, clearly labeled with sku & finish. Trim Kits are placed in a roll-up pouch to protect from scratches and fingerprints. Double-sided UHB tape is not included and can be purchased separately. *Images of roll-up pouch coming soon!*

Stock Finishes						NEW SWATCH COMING SOON!		
Finish Name	Brushed Aluminum	Chrome	Polished Brass	Satin Brass	Satin Stainless	Titanium *NEW 2024*	Warm Bronze	Flat Black
Finish Code	BA	CR	PB	SB	ST	TM	WB	WR

**.25" Aluminum Bar**



**SKU: 01110810SMPL**  
Kit includes a 12" sample of our .25" x .25" Aluminum Bar in each finish we offer.



**.5" Aluminum L-Channel**



**SKU: 01110030SMPL**  
Kit includes a 12" sample of our .5" Aluminum L-Channel in each finish we offer.



**.75" Aluminum Strap**



**SKU: 01STRAP75SMPL**  
Kit includes a 12" sample of our .75" Aluminum Strap in each finish we offer.



**.75"W x .25"T Aluminum Bar**



**SKU: 01110788SMPL**  
Kit includes a 12" sample of our .75"W x .25"T Aluminum Bar in each finish we offer.



**.875" Aluminum L-Channel**



**SKU: 01110451SMPL**  
Kit includes a 12" sample of our .875" Aluminum L-Channel in each finish we offer.



**1.25"W Aluminum Strap**



**SKU: 01110171SMPL**  
Kit includes a 12" sample of our 1.25"W Aluminum Bar in each finish we offer.



**Angled Decorative Bar**



**SKU: 01200250SMPL**  
Kit includes a 12" sample of our 1.25"W Aluminum Bar in each finish we offer.



## Metal Trim Kit (Aluminum and Brass)

- **SKU: 01METALTRIM**
- Kit includes a 12" sample of each Metallic Trim piece we offer, including Brass trim.
- (8) total pieces.
- (1) Roll-up pouch.
- Finishes vary.



## Metallic Color Chips

- **SKU: 01METALSAMPLE**
- 3.75"W x 8.5"L card.
- 1.25"W x 1"H anodized aluminum metallic chips.
- All finishes represented.



## Single Metallic Color Chip

- **SKU: 01METALSAMPLE**
- Must add finish code (noted below) to end of SKU when ordering.
- 2"W x 5.5"L card.
- (1) 1.25"W x 1"H anodized aluminum metallic chip.
- (1) color per card.



## Designer DripEdge® Color Chips

- **SKU: 01DRIPEDGECLR**
- 2"W x 4.5"L card.
- (3) 1.25"W x 1"H anodized aluminum metallic chips in Satin Brass, Brushed Aluminum and Flat Black.
- All finishes offered for Designer DripEdge® represented for a total of 3 color chips.



## Designer DripEdge Sample Kit

**SKU: 01DRIPEDGESMPL**

**KBB PRODUCT AWARDS 2023 WINNER**

The complete Sample Kit for our 2023 KBB Product Award-winning product, the Designer DripEdge®.

### Includes:

- (1) 12.75"L DripEdge in flat black.
- (1) Promotional Table Tent.
- (1) DripEdge Color Chip Card.
- (1) Felt pouch.

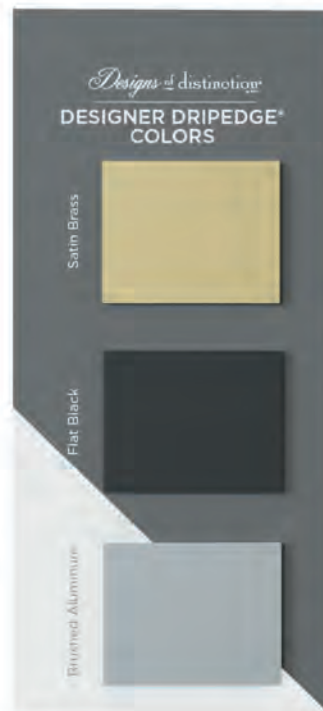

## Tambour Only Sample Box (01TAMBOURBOX)



- Includes 3" x 4" samples of each of our available solid & flexible tambour profiles for a total of (27) sample pieces.
- Tambour species may vary.
- (10) Tambour brochures.

## Countertop Tambour Display (01TAMBOURCNTR)



- (100) Tambour brochures.
- (2) Countertop display trays.
- (27) 6"W x 9"H flexible & solid Tambour samples, representing all Tambour profiles we carry.

## 12" X 24" Flexible Tambour Sample

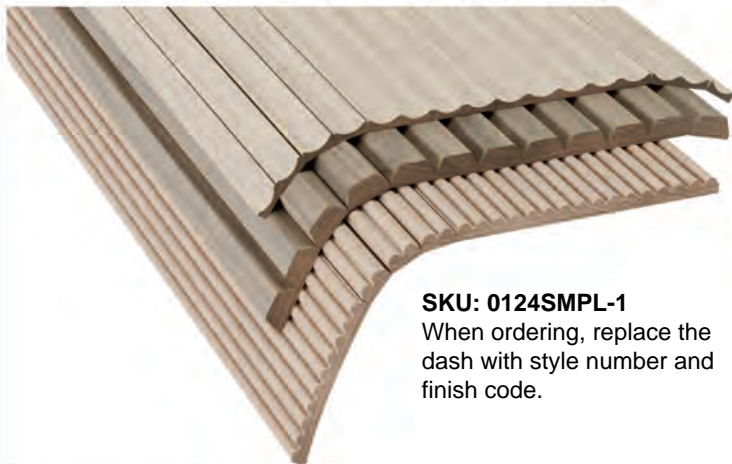

**SKU: 0124SMPL-1**  
When ordering, replace the dash with style number and finish code.

Choose any flexible Tambour style and species.  
Includes (1) 12"W x 24"L flexible Tambour piece.

## 12" X 24" Solid Tambour Sample

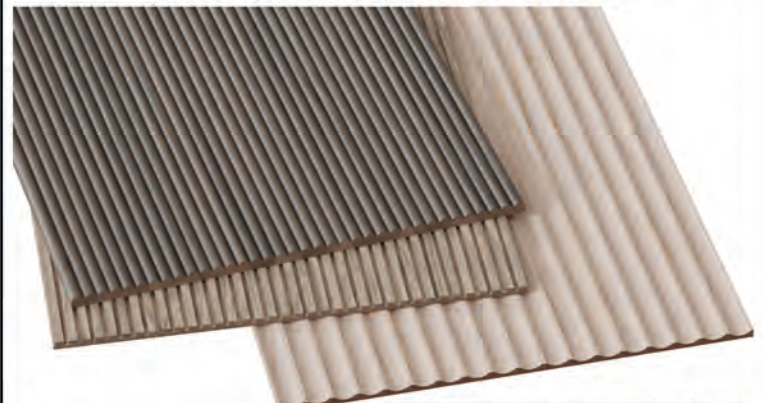

**SKU: 01SLDSMPL-1**  
When ordering, replace the dash with style number and finish code.

Choose any solid Tambour style and species.  
Includes (1) 12"W x 24"L solid Tambour piece.

## Tambour Sample Binder



- **SKU: 01TAMBOURBINDER**
- Real American hardwood tambour samples affixed to a rigid tri-fold binder.
- Conveniently sized at 10"W x 12"H x 2"D to fit on bookshelves.
- Clear vinyl sleeve on back of binder to include your business information.
- QR code to download product images, specifications, installation instructions, and more.

## Individual Tambour Samples



Tambour samples are clearly labeled with profile, style, and species.

## 10 Piece Gallery Rail Sample Kit



- **SKU: 01GALLERYRLMINI**
- (1) 12" sample rod in each finish we offer - Satin Brass, Polished Brass, Chrome, Flat Black, and Lacquered Stainless Steel - for a total of (5) rods.
- (5) Traditional end posts in each finish we offer.
- (1) Contemporary Gallery Rail post.

## 20 Piece Gallery Rail Sample Kit



- **SKU: 01GALLERYRLSET**
- (1) 12" sample rod in each finish we offer - Satin Brass, Polished Brass, Chrome, Flat Black, and Lacquered Stainless Steel - for a total of (5) rods.
- (15) posts - one in each style & finish.
- (1) Contemporary Gallery Rail corner collar.

### 4 Piece Traditional Gallery Rail Set - Chrome (CR)



#### SKU: 01GALLERYRAILCR

Kit includes (1) of each traditional gallery rail component in Chrome: end post, center post, corner post, 12" rod.

### 4 Piece Traditional Gallery Rail Set - Polished Brass (PB)



#### SKU: 01GALLERYRAILPB

Kit includes (1) of each traditional gallery rail component in Polished Brass: end post, center post, corner post, 12" rod.

### 4 Piece Traditional Gallery Rail Set - Satin Brass (SB)



#### SKU: 01GALLERYRAILSB

Kit includes (1) of each traditional gallery rail component in Satin Brass: end post, center post, corner post, 12" rod.

### 4 Piece Traditional Gallery Rail Set - Flat Black (WR)



#### SKU: 01GALLERYRAILWR

Kit includes (1) of each traditional gallery rail component in Flat Black: end post, center post, corner post, 12" rod.

### 4 Piece Single Contemporary Gallery Rail Set - Chrome (CR)



#### SKU: 01CONTRAILCR

Kit includes (1) of each contemporary gallery rail component in Chrome: end post, center post, corner collar, 12" rod.

### 4 Piece Single Contemporary Gallery Rail Set - Polished Brass (PB)



#### SKU: 01CONTRAILPB

Kit includes (1) of each contemporary gallery rail component in Polished Brass: end post, center post, corner collar, 12" rod.

**4 Piece Single Contemporary Gallery Rail Set - Satin Brass (SB)**



**SKU: 01CONTRAILSBS**

Kit includes (1) of each contemporary gallery rail component in Satin Brass: end post, center post, corner collar, 12" rod.

**4 Piece Single Contemporary Gallery Rail Set - Flat Black (WR)**



**SKU: 01CONTRAILWR**

Kit includes (1) of each contemporary gallery rail component in Flat Black: end post, center post, corner collar, 12" rod.

**4 Piece Single Contemporary Gallery Rail Set - Stainless Steel (SS)**



**SKU: 01CONTRAILSS**

Kit includes (1) of each contemporary gallery rail component in Stainless Steel: end post, center post, corner collar, 12" rod.

**4 Piece Double Contemporary Gallery Rail Set - Chrome (CR)**



**SKU: 01DBLCONTRAILCR**

Kit includes (1) of each double contemporary gallery rail component in Chrome: end post, center post, corner collar, 12" rod.

**4 Piece Double Contemporary Gallery Rail Set - Polished Brass (PB)**



**SKU: 01DBLCONTRAILPB**

Kit includes (1) of each double contemporary gallery rail component in Polished Brass: end post, center post, corner collar, 12" rod.

**4 Piece Double Contemporary Gallery Rail Set - Satin Brass (SB)**



**SKU: 01DBLCONTRAILSBS**

Kit includes (1) of each double contemporary gallery rail component in Satin Brass: end post, center post, corner collar, 12" rod.

**4 Piece Double Contemporary Gallery Rail Set - Flat Black (WR)**



**SKU: 01DBLCONTRAILWR**

Kit includes (1) of each double contemporary gallery rail component in Satin Brass: end post, center post, corner collar, 12" rod.

**4 Piece Double Contemporary Gallery Rail Set - Stainless Steel (SS)**



**SKU: 01DBLCONTRAILSS**

Kit includes (1) of each double contemporary gallery rail component in Satin Brass: end post, center post, corner collar, 12" rod.

## Showroom Materials Box

- **SKU: 01SAMPLEBOX22A**
- (50) brochures of each style (250 total)
- (1) Tambour Sample Kit
- (1) Decorative Grille & Mesh Sample Kit
- (1) 10 Piece Gallery Rail Kit
- (1) Italian Mesh Sample Kit
- (1) Metal Trim Kit
- (1) Leather Sample Kit
- (1) Resin Sample Kit
- (1) Rattan Sample Kit
- (1) Designer DripEdge Sample Kit
- (1) Showroom Materials Display Box



**Create Your Own Full Sample Kit** by combining any of our sample kits together. We will package in a Showroom Box and include all relevant marketing materials.

## Architect & Designer Client Sample Box

- **SKU: 01ADSAMPLE**
- (2) brochures of each style (10 total)
- (1) Diamond Weave Decorative Grille (DK08 double-sided grille)
- (1) Chevron Italian Mesh (style 107)
- (3) Tambour samples (1 bead style, 1 cove style, 1 square style - flexible & solid)
- (7) Metallic Trim samples
- (1) Rattan sample
- (1) Display Box



**Create Your Own Client Sample Kit.** Simply send us a list of samples you'd like to include in your A&D Client Sample Box. We will package in a Display Box and include all relevant marketing materials.

## Metallic Trim Sample Door Kit B

- **SKU: 01TRIMDOORB**
- Kit includes (1) 14" x 14" door, routed to fit all trim styles.
- (1) 3.75"W x 8.5"L aluminum color chip card with all (8) finishes we offer (01METALSAMPLE).
- 6" sample of each aluminum Metallic Trim piece we offer for a total of (7) trim pieces in flat black.
- (1) 12.75"L Designer DripEdge® in flat black.
- (25) Metallic Accent Trim Brochures.
- (1) cinch bag and (1) roll-up pouch.
- (1) canvas tote for travel (image coming soon).

